

Excalibur Low-Noise High-Speed Precision Operational Amplifiers

1 Features

- Low noise
 - 10Hz . . . $15\text{nV}/\sqrt{\text{Hz}}$
 - 1kHz . . . $10.5\text{nV}/\sqrt{\text{Hz}}$
- Load capability: 10000pF
- Short-circuit output current: 20mA (minimum)
- Slew rate: 27V/ μs (minimum)
- High gain-bandwidth product: 5.9MHz
- Low V_{IO} : 500 μV maximum at 25°C
- Single or split supply: 4V to 44V
- Fast settling time:
 - 340ns to 0.1%
 - 400ns to 0.01%
- Saturation recovery: 150ns
- Large output swing:
 - $V_{\text{CC-}} + 0.1\text{V}$ to $V_{\text{CC+}} - 1\text{V}$

2 Applications

- [EV charging infrastructure](#)
- [Industrial AC-DC](#)
- [Fire alarm control panel \(FACP\)](#)
- [String inverter](#)

3 Description

The TLE214x and TLE214xA devices are high-performance, internally compensated operational amplifiers built using Texas Instruments complementary bipolar Excalibur process. The TLE214xA is a tighter offset voltage grade of the TLE214x. Both are pin-compatible upgrades to standard industry products.

The design incorporates an input stage that simultaneously achieves low audio-band noise of $10.5\text{nV}/\sqrt{\text{Hz}}$ with a 10Hz 1/f corner and symmetrical 40V/ μs slew rate typically with loads up to 800pF. The resulting low distortion and high power bandwidth are important in high-fidelity audio applications. A fast settling time of 430ns to 0.1% of a 10V step with a 2k Ω /100pF load is useful in fast actuator/positioning drivers. Under similar test conditions, settling time to 0.01% is 640ns.

Both versions can also be used as comparators. Differential inputs of $V_{\text{CC}\pm}$ can be maintained without damage to the device. Open-loop propagation delay with TTL supply levels is typically 200ns. This gives a good indication as to output stage saturation recovery when the device is driven beyond the limits of recommended output swing.

Both the TLE214x and TLE214xA are available in a wide variety of packages, including both the industry-standard 8-pin small-outline version and chip form for high-density system applications. The C-suffix devices are characterized for operation from 0°C to 70°C, I-suffix devices from -40°C to 105°C, and M-suffix devices over the full military temperature range of -55°C to 125°C.

Package Information

PART NUMBER	PACKAGE ⁽¹⁾	PACKAGE SIZE ⁽²⁾
TLE2141, TLE2141A	P (PDIP, 8)	9.81mm × 9.43mm
	D (SOIC, 8)	4.9mm × 6mm
TLE2142	P (PDIP, 8)	9.81mm × 9.43mm
	D (SOIC, 8)	4.9mm × 6mm
	PW (TSSOP, 16)	5mm × 6.4mm
TLE2142A	D (SOIC, 8)	4.9mm × 6mm
TLE2142AM	JG (CDIP, 8)	9.6mm × 6.67mm
	U (CFP, 10)	21.44mm × 6.5mm
	FK (LCCC, 20)	8.89mm × 8.89mm
TLE2142AM-D	D (SOIC, 8)	4.9mm × 6mm
TLE2142M	JG (CDIP, 8)	9.6mm × 6.67mm
	U (CFP, 10)	21.44mm × 6.5mm
	FK (LCCC, 20)	8.89mm × 8.89mm
TLE2142M-D	D (SOIC, 8)	4.9mm × 6mm
TLE2144	N (PDIP, 14)	19.3mm × 9.4mm
	DW (SOIC, 16)	10.3mm × 10.3mm
TLE2144A	N (PDIP, 14)	19.3mm × 9.4mm
TLE2144AM, TLE2144M	J (CDIP, 14)	19.56mm × 6.67mm
	FK (LCCC, 20)	8.89mm × 8.89mm
TLE2144M-D	DW (SOIC, 16)	10.3mm × 10.3mm

(1) For all available packages, see [Section 9](#).

(2) The package size (length × width) is a nominal value and includes pins, where applicable.

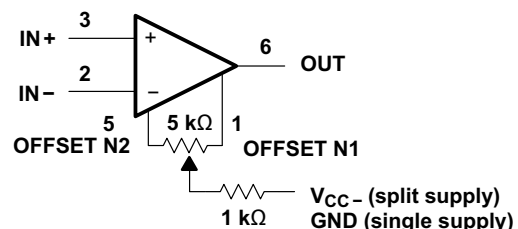

Input Offset Voltage Null Circuit



Table of Contents

1 Features	1	5.23 TLE2144I Electrical Characteristics.....	25
2 Applications	1	5.24 TLE2144C Operating Characteristics, $V_{CC} =$ 5V, $T_A = 25^\circ\text{C}$	26
3 Description	1	5.25 TLE2144I Electrical Characteristics.....	27
4 Pin Configuration and Functions	3	5.26 TLE2144I Operating Characteristics, $V_{CC\pm} =$ $\pm 15\text{V}$, $T_A = 25^\circ\text{C}$	28
5 Specifications	4	5.27 TLE2144I Electrical Characteristics.....	29
5.1 Absolute Maximum Ratings.....	4	5.28 TLE2141M Operating Characteristics, $V_{CC} =$ 5V, $T_A = 25^\circ\text{C}$	30
5.2 Recommended Operating Conditions.....	4	5.29 TLE2141M Electrical Characteristics.....	31
5.3 TLE2141C Electrical Characteristics.....	5	5.30 TLE2141M Operating Characteristics, $V_{CC\pm} =$ $\pm 15\text{V}$, $T_A = 25^\circ\text{C}$	32
5.4 TLE2141C Operating Characteristics, $V_{CC} = 5\text{V}$, $T_A = 25^\circ\text{C}$	6	5.31 TLE2142M Electrical Characteristics.....	33
5.5 TLE2141C Electrical Characteristics.....	7	5.32 TLE2142M Operating Characteristics, $V_{CC} =$ 5V, $T_A = 25^\circ\text{C}$	34
5.6 TLE2141C Operating Characteristics, $V_{CC\pm} =$ $\pm 15\text{V}$, $T_A = 25^\circ\text{C}$	8	5.33 TLE2142M Electrical Characteristics.....	35
5.7 TLE2142C Electrical Characteristics.....	9	5.34 TLE2142M Operating Characteristics, $V_{CC\pm} =$ $\pm 15\text{V}$, $T_A = 25^\circ\text{C}$	36
5.8 TLE2142C Operating Characteristics, $V_{CC} = 5\text{V}$, $T_A = 25^\circ\text{C}$	10	5.35 TLE2144M Electrical Characteristics.....	37
5.9 TLE2142C Electrical Characteristics.....	11	5.36 TLE2144M Operating Characteristics.....	38
5.10 TLE2142C Operating Characteristics, $V_{CC\pm} =$ $\pm 15\text{V}$, $T_A = 25^\circ\text{C}$	12	5.37 TLE2144M Electrical Characteristics.....	39
5.11 TLE2144C Electrical Characteristics.....	13	5.38 TLE2144M Operating Characteristics.....	40
5.12 TLE2144C Operating Characteristics, $V_{CC} =$ 5V, $T_A = 25^\circ\text{C}$	14	5.39 TLE2141Y Electrical Characteristics.....	41
5.13 TLE2144C Electrical Characteristics.....	15	5.40 TLE2142Y Electrical Characteristics.....	42
5.14 TLE2144C Operating Characteristics, $V_{CC\pm} =$ $\pm 15\text{V}$, $T_A = 25^\circ\text{C}$	16	5.41 TLE2144Y Electrical Characteristics.....	43
5.15 TLE2141I Electrical Characteristics.....	17	5.42 Typical Characteristics.....	44
5.16 TLE2141I Operating Characteristics, $V_{CC} =$ 5V, $T_A = 25^\circ\text{C}$	18	6 Detailed Description	54
5.17 TLE2141I Electrical Characteristics.....	19	6.1 Overview.....	54
5.18 TLE2141I Operating Characteristics, $V_{CC\pm} =$ $\pm 15\text{V}$, $T_A = 25^\circ\text{C}$	20	7 Device and Documentation Support	55
5.19 TLE2142I Electrical Characteristics.....	21	7.1 Receiving Notification of Documentation Updates....	55
5.20 TLE2142I Operating Characteristics, $V_{CC} =$ 5V, $T_A = 25^\circ\text{C}$	22	7.2 Support Resources.....	55
5.21 TLE2142I Electrical Characteristics.....	23	7.3 Trademarks.....	55
5.22 TLE2142I Operating Characteristics, $V_{CC\pm} =$ $\pm 15\text{V}$, $T_A = 25^\circ\text{C}$	24	7.4 Electrostatic Discharge Caution.....	55
		7.5 Glossary.....	55
		8 Revision History	55
		9 Mechanical, Packaging, and Orderable Information ..	55

5 Specifications

5.1 Absolute Maximum Ratings

over operating free-air temperature range (unless otherwise noted)⁽¹⁾

		VALUE	UNIT	
V _{CC+}	Supply voltage ⁽²⁾	22	V	
V _{CC-}	Supply voltage	-22	V	
V _{ID}	Differential input voltage ⁽³⁾	±44	V	
V _I	Input voltage range, (any input)	V _{CC+} to V _{CC-} -0.3	V	
I _I	Input current (each input)	± 1	mA	
I _O	Output current	± 80	mA	
Total current into V _{CC+}		80	mA	
Total current out of V _{CC-}		80	mA	
Duration of short-circuit current at (or below) 25°C ⁽⁴⁾		Unlimited		
θ _{JA}	Package thermal impedance ^{(5) (6)}	D package	97.1	°C/W
		DW package	57.3	
		N package	79.7	
		P package	84.6	
		PW package	108.4	
θ _{JC}	Package thermal impedance ^{(5) (6)}	FK package	5.6	°C/W
		J package	15.1	
		JG package	14.5	
		U package	14.7	
T _A	Operating free-air temperature range	C suffix	0 to 70	°C
		I suffix	-40 TO 105	°C
		M suffix	-55 TO 125	°C
Storage temperature range		-65 TO 150	°C	
Case temperature for 60 seconds: FK package		260	°C	
Lead temperature 1,6 mm (1/16 inch) from case for 10 seconds: D, DW, N, P, or PW package		260	°C	
Lead temperature 1,6 mm (1/16 inch) from case for 60 seconds: J or JG package		300	°C	

- Stresses beyond those listed under “absolute maximum ratings” may cause permanent damage to the device. These are stress ratings only, and functional operation of the device at these or any other conditions beyond those indicated under “recommended operating conditions” is not implied. Exposure to absolute-maximum-rated conditions for extended periods may affect device reliability.
- All voltage values, except differential voltages, are with respect to the midpoint between V_{CC+} and V_{CC-}.
- Differential voltages are at IN+ with respect to IN-. Excessive current flows, if input, are brought below V_{CC-} -0.3V.
- The output may be shorted to either supply. Temperature and /or supply voltages must be limited to make sure that the maximum dissipation rating is not exceeded.
- Maximum power dissipation is a function of T_{J(max)}, θ_{JA}, and T_A. The maximum allowable power dissipation at any allowable ambient temperature is P_D = (T_{J(max)} - T_A)/θ_{JA}. Operating at the absolute maximum T_J of 150°C can affect reliability.
- The package thermal impedance is calculated in accordance with JESD 51-7 (plastic) or MIL-STD-883 Method 1012 (ceramic).

5.2 Recommended Operating Conditions

over operating free-air temperature range (unless otherwise noted)

		C SUFFIX		I SUFFIX		M SUFFIX		UNIT
		MIN	MAX	MIN	MAX	MIN	MAX	
V _{CC±}	Supply voltage	±2	±22	±2	±22	±2	±22	V
V _{IC}	Common-mode input voltage	V _{CC} = 5V		0	2.9	0	2.7	V
		V _{CC±} = ± 15V		-15	12.9	-15	12.7	
T _A	Operating free-air temperature	0	70	-40	105	-55	125	°C

5.3 TLE2141C Electrical Characteristics

at specified free-air temperature, $V_{CC} = 5V$ (unless otherwise noted)

PARAMETER	TEST CONDITIONS	T_A (1)	TLE2141C			TLE2141AC			UNIT
			MIN	TYP	MAX	MIN	TYP	MAX	
V_{IO} Input offset voltage		25°C	225	1400		200	1000	μV	
		Full range			1700		1300		
α_{VIO} Temperature coefficient of input offset voltage	$V_O = 2.5V, R_S = 50\Omega, V_{IC} = 2.5V$	Full range	1.7			1.7		$\mu V/^\circ C$	
I_{IO} Input offset current		25°C	8	100		8	100	nA	
		Full range			150		150		
I_{IB} Input bias current		25°C	-0.8	-2		-0.8	-2	μA	
	Full range			-2.1		-2.1			
V_{ICR} Common-mode input voltage range	$R_S = 50\Omega$	25°C	0 to 3	-0.3 to 3.2		0 to 3	-0.3 to 3.2	V	
		Full range	0 to 2.9			0 to 2.9		V	
V_{OH} High-level output voltage	$I_{OH} = -150\mu A$	25°C	3.9	4.1		3.9	4.1	V	
		Full range	3.8			3.8			
	$I_{OH} = -1.5mA$	25°C	3.8	4		3.8	4	V	
		Full range	3.7			3.7			
	$I_{OH} = -15mA$	25°C	3.2	3.7		3.2	3.7	V	
		Full range	3.2			3.2			
V_{OL} Low-level output voltage	$I_{OL} = 150\mu A$	25°C		75	125		75	125	mV
		Full range			150		150		
	$I_{OL} = 1.5mA$	25°C		150	225		150	225	mV
		Full range			250		250		
	$I_{OL} = 15mA$	25°C		1.2	1.5		1.2	1.5	V
		Full range			1.7		1.7		
A_{VD} Large-signal differential voltage amplification	$V_{CC} = \pm 2.5V, R_L = 2k\Omega, V_O = 1V \text{ to } -1.5V$	25°C	50	220		50	220	V/mV	
		Full range	25			25			
r_i Input resistance		25°C	70			70	$M\Omega$		
c_i Input capacitance		25°C	2.5			2.5	pF		
Z_o Open-loop output impedance	$f = 1MHz$	25°C	30			30	Ω		
CMRR Common-mode rejection ratio	$V_{IC} = V_{ICRmin}, R_S = 50\Omega$	25°C	85	118		85	118	dB	
		Full range	80			80			
k_{SVR} Supply-voltage rejection ratio ($\Delta V_{CC\pm} / \Delta V_{IO}$)	$V_{CC\pm} = \pm 2.5V \text{ to } \pm 15V, R_S = 50\Omega$	25°C	90	106		90	106	dB	
		Full range	85			85			
I_{CC} Supply current	$V_O = 2.5V, \text{ No load}, V_{IC} = 2.5V$	25°C	3.4	4.4		3.4	4.4	mA	
		Full range			4.6		4.6		

(1) Full range is 0°C to 70°C.

5.4 TLE2141C Operating Characteristics, $V_{CC} = 5V$, $T_A = 25^\circ C$

PARAMETER	TEST CONDITIONS	TLE2141C			TLE2141AC			UNIT
		MIN	TYP	MAX	MIN	TYP	MAX	
SR+	Positive slew rate	$A_{VD} = -1$, $R_L = 2k\Omega$, ⁽¹⁾ $C_L = 500pF$ ⁽¹⁾			45			V/ μs
SR-	Negative slew rate				42			
t_s	Settling time	$A_{VD} = -1$, 2.5V step	To 0.1%	0.66			μs	
			To 0.01%	0.99				
V_n	Equivalent input noise voltage	$R_S = 20\Omega$, $f = 10Hz$			15			nV/ \sqrt{Hz}
		$R_S = 20\Omega$, $f = 1kHz$			10.5			
$V_{N(PP)}$	Peak-to-peak equivalent input noise voltage	$f = 0.1Hz$ to 1Hz			0.48			μV
		$f = 0.1Hz$ to 10Hz			0.51			
I_n	Equivalent input noise current	$f = 10Hz$			1.92			pA/ \sqrt{Hz}
		$f = 1kHz$			0.5			
THD + N	Total harmonic distortion plus noise	$V_O = 1V$ to 3V, $R_L = 2k\Omega$, ⁽¹⁾ $A_{VD} = 2$, $f = 10kHz$			0.0052%			
B_1	Unity-gain bandwidth	$R_L = 2k\Omega$ ⁽¹⁾ , $C_L = 100pF$ ⁽¹⁾			5.9			MHz
	Gain-bandwidth product	$R_L = 2k\Omega$ ⁽¹⁾ , $C_L = 100pF$, ⁽¹⁾ $f = 100kHz$			5.8			MHz
B_{OM}	Maximum output-swing bandwidth ⁽²⁾	$V_{O(PP)} = 2V$, $R_L = 2k\Omega$, ⁽¹⁾ $A_{VD} = 1$, $C_L = 100pF$ ⁽¹⁾			380			kHz
ϕ_m	Phase margin at unity gain	$R_L = 2k\Omega$ ⁽¹⁾ , $C_L = 100pF$ ⁽¹⁾			57°			

- (1) R_L and C_L terminated to 2.5V.
 (2) Measured at -0.1dB.

5.5 TLE2141C Electrical Characteristics

at specified free-air temperature, $V_{CC\pm} = \pm 15V$ (unless otherwise noted)

PARAMETER	TEST CONDITIONS	T_A (1)	TLE2141C			TLE2141AC			UNIT
			MIN	TYP	MAX	MIN	TYP	MAX	
V_{IO} Input offset voltage		25°C		200	900		175	500	μV
		Full range			1300			800	
α_{VIO} Temperature coefficient of input offset voltage	$V_{IC} = 0V, R_S = 50\Omega, V_O = 0V$	Full range		1.7			1.7		$\mu V/^\circ C$
I_{IO} Input offset current		25°C		7	100		7	100	nA
		Full range			150			150	
I_{IB} Input bias current		25°C		-0.7	-1.5		-0.7	-1.5	μA
	Full range			-1.6			-1.6		
V_{ICR} Common-mode input voltage range	$R_S = 50\Omega$	25°C	-15 to 13	-15.3 to 13.2		-15 to 13	-15.3 to 13.2	V	
		Full range	-15 to 12.9	15.3 to 13.1		-15 to 12.9	-15.3 to 13.1	V	
V_{OM+} Maximum positive peak output voltage swing	$I_O = -150\mu A$	25°C	13.8	14.1		13.8	14.1	V	
		Full range		13.7			13.7		
	$I_O = -1.5mA$	25°C	13.7	14		13.7	14		
		Full range		13.6			13.6		
	$I_O = -15mA$	25°C	13.1	13.7		13.1	13.7		
		Full range		13			13		
V_{OM-} Maximum negative peak output voltage swing	$I_O = 150\mu A$	25°C	-14.7	-14.9		-14.7	-14.9	V	
		Full range		-14.6			-14.6		
	$I_O = 1.5mA$	25°C	-14.5	-14.8		-14.5	-14.8		
		Full range		-14.4			-14.4		
	$I_O = 15mA$	25°C	-13.4	-13.8		-13.4	-13.8		
		Full range		-13.3			-13.3		
A_{VD} Large-signal differential voltage amplification	$V_O = \pm 10V$	25°C	100	450		100	450	V/mV	
		Full range		75			75		
r_i Input resistance	$R_L = 2k\Omega$	25°C		65			65	$M\Omega$	
c_i Input capacitance		25°C		2.5			2.5	pF	
Z_o Open-loop output impedance	$f = 1MHz$	25°C		30			30	Ω	
CMRR Common-mode rejection ratio	$V_{IC} = V_{ICRmin}, R_S = 50\Omega$	25°C	85	108		85	108	dB	
		Full range		80			80		
k_{SVR} Supply-voltage rejection ratio ($\Delta V_{CC\pm} / \Delta V_{IO}$)	$V_{CC\pm} = \pm 2.5V$ to $\pm 15V$, $R_S = 50\Omega$	25°C	90	106		90	106	dB	
		Full range		85			85		
I_{OS} Short circuit output current	$V_O = 0$	25°C	$V_{ID} = 1V$	-25	-50		-25	-50	mA
			$V_{ID} = -1V$	20	31		20	31	
I_{CC} Supply current	$V_O = 0V$, No load	25°C		3.5	4.5		3.5	4.5	mA
		Full range			4.7			4.7	

(1) Full range is 0°C to 70°C.

5.6 TLE2141C Operating Characteristics, $V_{CC\pm} = \pm 15V$, $T_A = 25^\circ C$

PARAMETER	TEST CONDITIONS	TLE2141C			TLE2141AC			UNIT
		MIN	TYP	MAX	MIN	TYP	MAX	
SR+	Positive slew rate	$A_{VD} = -1, R_L = 2k\Omega, C_L = 500pF$						V/ μs
SR-	Negative slew rate							
t_s	Settling time	$A_{VD} = -1, 10V$ step	To 0.1%	0.43			μs	
			To 0.01%	0.64				
V_n	Equivalent input noise voltage	$R_S = 20\Omega, f = 10Hz$						nV/ \sqrt{Hz}
		$R_S = 20\Omega, f = 1kHz$						
$V_{N(PP)}$	Peak-to-peak equivalent input noise voltage	$f = 0.1Hz$ to $1Hz$						μV
		$f = 0.1Hz$ to $10Hz$						
I_n	Equivalent input noise current	$f = 10Hz$						pA/ \sqrt{Hz}
		$f = 1kHz$						
THD + N	Total harmonic distortion plus noise	$V_{O(PP)} = 20V, R_L = 2k\Omega, A_{VD} = 10, f = 10kHz$ ⁽¹⁾						
B_1	Unity-gain bandwidth	$R_L = 2k\Omega, C_L = 100pF$ ⁽¹⁾						MHz
	Gain-bandwidth product	$R_L = 2k\Omega, C_L = 100pF, f = 100kHz$ ⁽¹⁾						MHz
B_{OM}	Maximum output-swing bandwidth ⁽³⁾	$V_{O(PP)} = 2V, R_L = 2k\Omega, A_{VD} = 1, C_L = 100pF$ ⁽¹⁾						kHz
ϕ_m	Phase margin at unity gain	$R_L = 2k\Omega, C_L = 100pF$ ⁽¹⁾						58°

- (1) R_L and C_L terminated to 2.5V .
- (2) Specified by characterization.
- (3) Measured at -0.1dB.

5.7 TLE2142C Electrical Characteristics

at specified free-air temperature, $V_{CC} = 5V$ (unless otherwise noted)

PARAMETER	TEST CONDITIONS	T_A ⁽¹⁾	TLE2142C			TLE2142AC			UNIT
			MIN	TYP	MAX	MIN	TYP	MAX	
V_{IO} Input offset voltage		25°C		220	1900		200	1500	μV
		Full range			2200			1800	
α_{VIO} Temperature coefficient of input offset voltage	$V_O = 2.5V, R_S = 50\Omega, V_{IC} = 2.5V$	Full range		1.7			1.7		$\mu V/^\circ C$
I_{IO} Input offset current		25°C		8	100		8	100	nA
		Full range			150			150	
I_{IB} Input bias current		25°C		-0.8	-2		-0.8	-2	μA
	Full range			-2.1			-2.1		
V_{ICR} Common-mode input voltage range	$R_S = 50\Omega$	25°C	0 to 3	-0.3 to 3.2		0 to 3	-0.3 to 3.2	V	
		Full range	0 to 2.9			0 to 2.9		V	
V_{OH} High-level output voltage	$I_{OH} = -150\mu A$	25°C	3.9	4.1		3.9	4.1	V	
		Full range	3.8			3.8			
	$I_{OH} = -1.5mA$	25°C	3.8	4		3.8	4	V	
		Full range	3.7			3.7			
	$I_{OH} = -15mA$	25°C	3.4	3.7		3.4	3.7	V	
		Full range	3.4			3.4			
V_{OL} Low-level output voltage	$I_{OL} = 150\mu A$	25°C		75	125		75	125	mV
		Full range			150			150	
	$I_{OL} = 1.5mA$	25°C		150	225		150	225	mV
		Full range			250			250	
	$I_{OL} = 15mA$	25°C		1.2	1.4		1.2	1.4	V
		Full range			1.5			1.5	
A_{VD} Large-signal differential voltage amplification	$V_{CC} = \pm 2.5V, R_L = 2k\Omega, V_O = 1V \text{ to } -1.5V$	25°C	50	220		50	220	V/mV	
		Full range	25			25			
r_i Input resistance		25°C		70			70	M Ω	
c_i Input capacitance		25°C		2.5			2.5	pF	
Z_o Open-loop output impedance	$f = 1MHz$	25°C		30			30	Ω	
CMRR Common-mode rejection ratio	$V_{IC} = V_{ICRmin}, R_S = 50\Omega$	25°C	85	118		85	118	dB	
		Full range	80			80			
k_{SVR} Supply-voltage rejection ratio ($\Delta V_{CC\pm} / \Delta V_{IO}$)	$V_{CC\pm} = \pm 2.5V \text{ to } \pm 15V, R_S = 50\Omega$	25°C	90	106		90	106	dB	
		Full range	85			85			
I_{CC} Supply current	$V_O = 2.5V, \text{ No load}, V_{IC} = 2.5V$	25°C		6.6	8.8		6.6	8.8	mA
		Full range			9.2			9.2	

(1) Full range is 0°C to 70°C.

5.8 TLE2142C Operating Characteristics, $V_{CC} = 5V$, $T_A = 25^\circ C$

PARAMETER	TEST CONDITIONS	TLE2142C			TLE2142AC			UNIT
		MIN	TYP	MAX	MIN	TYP	MAX	
SR+	Positive slew rate	$A_{VD} = -1$, $R_L = 2k\Omega$, ⁽¹⁾ $C_L = 500pF$		45	45		V/ μs	
SR-	Negative slew rate			42	42			
t_s	Settling time	$A_{VD} = -1$, 2.5V step	To 0.1%	0.66		μs		
			To 0.01%	0.99				
V_n	Equivalent input noise voltage	$R_S = 20\Omega$, $f = 10Hz$		15		nV/ \sqrt{Hz}		
		$R_S = 20\Omega$, $f = 1kHz$		10.5				
$V_{N(PP)}$	Peak-to-peak equivalent input noise voltage	$f = 0.1Hz$ to 1Hz		0.48		μV		
		$f = 0.1Hz$ to 10Hz		0.51				
I_n	Equivalent input noise current	$f = 10Hz$		1.92		pA/ \sqrt{Hz}		
		$f = 1kHz$		0.5				
THD + N	Total harmonic distortion plus noise	$V_O = 1V$ to 3V, $R_L = 2k\Omega$, ⁽¹⁾ $A_{VD} = 2$, $f = 10kHz$		0.0052%		0.0052%		
B_1	Unity-gain bandwidth	$R_L = 2k\Omega$ ⁽¹⁾ , $C_L = 100pF$		5.9		MHz		
	Gain-bandwidth product	$R_L = 2k\Omega$ ⁽¹⁾ , $C_L = 100pF$, $f = 100kHz$		5.8		MHz		
B_{OM}	Maximum output-swing bandwidth ⁽²⁾	$V_{O(PP)} = 2V$, $R_L = 2k\Omega$, ⁽¹⁾ $A_{VD} = 1$, $C_L = 100pF$		380		kHz		
ϕ_m	Phase margin at unity gain	$R_L = 2k\Omega$ ⁽¹⁾ , $C_L = 100pF$		57°				

- (1) R_L terminated to 2.5V .
 (2) Measured at -0.1dB.

5.9 TLE2142C Electrical Characteristics

at specified free-air temperature, $V_{CC\pm} = \pm 15V$ (unless otherwise noted)

PARAMETER	TEST CONDITIONS	T_A ⁽¹⁾	TLE2142C			TLE2142AC			UNIT
			MIN	TYP	MAX	MIN	TYP	MAX	
V_{IO} Input offset voltage		25°C		290	1200		275	750	μV
		Full range			1600			1200	
α_{VIO} Temperature coefficient of input offset voltage	$V_{IC} = 0V, R_S = 50\Omega, V_O = 0V$	Full range		1.7			1.7		$\mu V/^\circ C$
I_{IO} Input offset current		25°C		7	100		7	100	nA
		Full range			150			150	
I_{IB} Input bias current		25°C		-0.7	-1.5		-0.7	-1.5	μA
	Full range			-1.6			-1.6		
V_{ICR} Common-mode input voltage range	$R_S = 50\Omega$	25°C	-15 to 13	-15.3 to 13.2		-15 to 13	-15.3 to 13.2	V	
		Full range	-15 to 12.9	15.3 to 13.1		-15 to 12.9	-15.3 to 13.1	V	
V_{OM+} Maximum positive peak output voltage swing	$I_O = -150\mu A$	25°C	13.8	14.1		13.8	14.1	V	
		Full range		13.7			13.7		
	$I_O = -1.5mA$	25°C	13.7	14		13.7	14		
		Full range		13.6			13.6		
	$I_O = -15mA$	25°C	13.3	13.7		13.2	13.7		
		Full range		13.2			13.2		
V_{OM-} Maximum negative peak output voltage swing	$I_O = 150\mu A$	25°C	-14.7	-14.9		-14.7	-14.9	V	
		Full range		-14.6			-14.6		
	$I_O = 1.5mA$	25°C	-14.5	-14.8		-14.5	-14.8		
		Full range		-14.4			-14.4		
	$I_O = 15mA$	25°C	-13.4	-13.8		-13.4	-13.8		
		Full range		-13.3			-13.3		
A_{VD} Large-signal differential voltage amplification	$V_O = \pm 10V$	25°C	100	450		100	450	V/mV	
		Full range		75			75		
r_i Input resistance	$R_L = 2k\Omega$	25°C		65			65	M Ω	
c_i Input capacitance		25°C		2.5			2.5	pF	
Z_o Open-loop output impedance	$f = 1MHz$	25°C		30			30	Ω	
CMRR Common-mode rejection ratio	$V_{IC} = V_{ICRmin}, R_S = 50\Omega$	25°C	85	108		85	108	dB	
		Full range		80			80		
k_{SVR} Supply-voltage rejection ratio ($\Delta V_{CC\pm} / \Delta V_{IO}$)	$V_{CC\pm} = \pm 2.5V$ to $\pm 15V$, $R_S = 50\Omega$	25°C	90	106		90	106	dB	
		Full range		85			85		
I_{OS} Short circuit output current	$V_O = 0$	25°C	$V_{ID} = 1V$	-25	-50		-25	-50	mA
			$V_{ID} = -1V$	20	31		20	31	
I_{CC} Supply current	$V_O = 0V$, No load	25°C		6.9	9		6.9	9	mA
		Full range			9.4			9.4	

(1) Full range is 0°C to 70°C.

5.10 TLE2142C Operating Characteristics, $V_{CC\pm} = \pm 15V$, $T_A = 25^\circ C$

PARAMETER	TEST CONDITIONS	TLE2142C			TLE2142AC			UNIT
		MIN	TYP	MAX	MIN	TYP	MAX	
SR+	Positive slew rate	$A_{VD} = -1, R_L = 2k\Omega, C_L = 500pF$		27 ⁽²⁾	45	27 ⁽²⁾	45	V/ μs
SR-	Negative slew rate			27 ⁽²⁾	42	27 ⁽²⁾	42	
t_s	Settling time	$A_{VD} = -1, 10V$ step	To 0.1%	0.43			μs	
			To 0.01%	0.64				
V_n	Equivalent input noise voltage	$R_S = 20\Omega, f = 10Hz$		15			nV/ \sqrt{Hz}	
		$R_S = 20\Omega, f = 1kHz$		10.5				
$V_{N(PP)}$	Peak-to-peak equivalent input noise voltage	$f = 0.1Hz$ to 1Hz		0.48			μV	
		$f = 0.1Hz$ to 10Hz		0.51				
I_n	Equivalent input noise current	$f = 10Hz$		1.89			pA/ \sqrt{Hz}	
		$f = 1kHz$		0.47				
THD + N	Total harmonic distortion plus noise	$V_{O(PP)} = 20V, R_L = 2k\Omega, A_{VD} = 10, f = 10kHz$ ⁽¹⁾		0.06%				
B_1	Unity-gain bandwidth	$R_L = 2k\Omega, C_L = 100pF$ ⁽¹⁾		6			MHz	
	Gain-bandwidth product	$R_L = 2k\Omega, C_L = 100pF, f = 100kHz$ ⁽¹⁾		5.9			MHz	
B_{OM}	Maximum output-swing bandwidth ⁽¹⁾	$V_{O(PP)} = 2V, R_L = 2k\Omega, A_{VD} = 1, C_L = 100pF$ ⁽¹⁾		668			kHz	
ϕ_m	Phase margin at unity gain	$R_L = 2k\Omega, C_L = 100pF$ ⁽¹⁾		58°				

(1) Measured at -0.1dB.

5.11 TLE2144C Electrical Characteristics

at specified free-air temperature, $V_{CC} = 5V$ (unless otherwise noted)

PARAMETER	TEST CONDITIONS	T_A (1)	TLE2144C			TLE2144AC			UNIT
			MIN	TYP	MAX	MIN	TYP	MAX	
V_{IO} Input offset voltage		25°C	0.5		3.8	0.5		3	mV
		Full range			4.4			3.6	
α_{VIO} Temperature coefficient of input offset voltage	$V_O = 2.5V, R_S = 50\Omega, V_{IC} = 2.5V$	Full range	1.7			1.7			$\mu V/^\circ C$
I_{IO} Input offset current		25°C	8		100	8		100	nA
		Full range			150			150	
I_{IB} Input bias current		25°C	-0.8		-2	-0.8		-2	μA
	Full range			-2.1			-2.1		
V_{ICR} Common-mode input voltage range	$R_S = 50\Omega$	25°C	0 to 3	-0.3 to 3.2		0 to 3	-0.3 to 3.2	V	
		Full range	0 to 2.9			0 to 2.9		V	
V_{OH} High-level output voltage	$I_{OH} = -150\mu A$	25°C	3.9	4.1		3.9	4.1	V	
		Full range	3.8			3.8			
	$I_{OH} = -1.5mA$	25°C	3.8	4		3.8	4	V	
		Full range	3.7			3.7			
	$I_{OH} = -15mA$	25°C	3.4	3.7		3.4	3.7	V	
		Full range	3.4			3.4			
V_{OL} Low-level output voltage	$I_{OL} = 150\mu A$	25°C	75		125	75		125	mV
		Full range			150			150	
	$I_{OL} = 1.5mA$	25°C	150		225	150		225	mV
		Full range			250			250	
	$I_{OL} = 15mA$	25°C	1.2		1.6	1.2		1.6	V
		Full range			1.7			1.7	
A_{VD} Large-signal differential voltage amplification	$V_{CC} = \pm 2.5V, R_L = 2k\Omega, V_O = 1V \text{ to } -1.5V$	25°C	50	95		50	95	V/mV	
		Full range	25			25			
r_i Input resistance		25°C	70			70		M Ω	
c_i Input capacitance		25°C	2.5			2.5		pF	
Z_o Open-loop output impedance	$f = 1MHz$	25°C	30			30		Ω	
CMRR Common-mode rejection ratio	$V_{IC} = V_{ICRmin}, R_S = 50\Omega$	25°C	85	118		85	118	dB	
		Full range	80			80			
k_{SVR} Supply-voltage rejection ratio ($\Delta V_{CC\pm} / \Delta V_{IO}$)	$V_{CC\pm} = \pm 2.5V \text{ to } \pm 15V, R_S = 50\Omega$	25°C	90	106		90	106	dB	
		Full range	85			85			
I_{CC} Supply current	$V_O = 2.5V, \text{ No load}, V_{IC} = 2.5V$	25°C	13.2	17.6		13.2	17.6	mA	
		Full range	18.5			18.5			

(1) Full range is 0°C to 70°C.

5.12 TLE2144C Operating Characteristics, $V_{CC} = 5V$, $T_A = 25^\circ C$

PARAMETER	TEST CONDITIONS	TLE2144C			TLE2144AC			UNIT
		MIN	TYP	MAX	MIN	TYP	MAX	
SR+	Positive slew rate	$A_{VD} = -1$, $R_L = 2k\Omega^{(1)}$, $C_L = 500pF$			45			V/ μs
SR-	Negative slew rate				42			
t_s	Settling time	$A_{VD} = -1$, 2.5V step		To 0.1%	0.66		μs	
				To 0.01%	0.99			
V_n	Equivalent input noise voltage	$R_S = 20\Omega$, $f = 10Hz$		15		nV/ \sqrt{Hz}		
		$R_S = 20\Omega$, $f = 1kHz$		10.5				
$V_{N(PP)}$	Peak-to-peak equivalent input noise voltage	$f = 0.1Hz$ to 1Hz		0.48		μV		
		$f = 0.1Hz$ to 10Hz		0.51				
I_n	Equivalent input noise current	$f = 10Hz$		1.92		pA/ \sqrt{Hz}		
		$f = 1kHz$		0.5				
THD + N	Total harmonic distortion plus noise	$V_O = 1V$ to 3V, $R_L = 2k\Omega^{(1)}$, $A_{VD} = 2$, $f = 10kHz$			0.0052%			
B_1	Unity-gain bandwidth	$R_L = 2k\Omega^{(1)}$, $C_L = 100pF$		5.9		MHz		
	Gain-bandwidth product	$R_L = 2k\Omega^{(1)}$, $C_L = 100pF$, $f = 100kHz$		5.8		MHz		
B_{OM}	Maximum output-swing bandwidth ⁽²⁾	$V_{O(PP)} = 2V$, $R_L = 2k\Omega^{(1)}$, $A_{VD} = 1$, $C_L = 100pF$		380		kHz		
ϕ_m	Phase margin at unity gain	$R_L = 2k\Omega^{(1)}$, $C_L = 100pF$		57°				

- (1) R_L terminated to 2.5V .
 (2) Measured at -0.1dB.

5.13 TLE2144C Electrical Characteristics

at specified free-air temperature, $V_{CC\pm} = \pm 15V$ (unless otherwise noted)

PARAMETER	TEST CONDITIONS	T_A (1)	TLE2144C			TLE2144AC			UNIT
			MIN	TYP	MAX	MIN	TYP	MAX	
V_{IO} Input offset voltage		25°C		0.6	2.4		0.5	1.5	μV
		Full range			3.2			2.4	
α_{VIO} Temperature coefficient of input offset voltage	$V_{IC} = 0, R_S = 50\Omega, V_O = 0$	Full range		1.7			1.7		$\mu V/^\circ C$
I_{IO} Input offset current		25°C		7	100		7	100	nA
		Full range			150			150	
I_{IB} Input bias current		25°C		-0.7	-1.5		-0.7	-1.5	μA
	Full range			-1.6			-1.6		
V_{ICR} Common-mode input voltage range	$R_S = 50\Omega$	25°C	-15 to 13	-15.3 to 13.2		-15 to 13	-15.3 to 13.2	V	
		Full range	-15 to 12.9	15.3 to 13.1		-15 to 12.9	-15.3 to 13.1	V	
V_{OM+} Maximum positive peak output voltage swing	$I_O = -150\mu A$	25°C	13.8	14.1		13.8	14.1	V	
		Full range		13.7			13.7		
	$I_O = -1.5mA$	25°C	13.7	14		13.7	14		
		Full range		13.6			13.6		
	$I_O = -15mA$	25°C	13.1	13.7		13.1	13.7		
		Full range		13			13		
V_{OM-} Maximum negative peak output voltage swing	$I_O = 150\mu A$	25°C	-14.7	-14.9		-14.7	-14.9	V	
		Full range		-14.6			-14.6		
	$I_O = 1.5mA$	25°C	-14.5	-14.8		-14.5	-14.8		
		Full range		-14.4			-14.4		
	$I_O = 15mA$	25°C	-13.4	-13.8		-13.4	-13.8		
		Full range		-13.3			-13.3		
A_{VD} Large-signal differential voltage amplification	$V_O = \pm 10V, R_L = 2k\Omega$	25°C	100	170		100	170	V/mV	
		Full range		75			75		
r_i Input resistance		25°C		65			65	M Ω	
c_i Input capacitance		25°C		2.5			2.5	pF	
Z_o Open-loop output impedance	$f = 1MHz$	25°C		30			30	Ω	
CMRR Common-mode rejection ratio	$V_{IC} = V_{ICRmin}, R_S = 50\Omega$	25°C	85	108		85	108	dB	
		Full range		80			80		
k_{SVR} Supply-voltage rejection ratio ($\Delta V_{CC\pm} / \Delta V_{IO}$)	$V_{CC\pm} = \pm 2.5V$ to $\pm 15V, R_S = 50\Omega$	25°C	90	106		90	106	dB	
		Full range		85			85		
I_{OS} Short circuit output current	$V_O = 0$	25°C	$V_{ID} = 1V$	-25	-50		-25	-50	mA
			$V_{ID} = -1V$	20	31		20	31	
I_{CC} Supply current	$V_O = 0V, \text{No load}$	25°C		13.8	18		13.8	18	mA
		Full range			18.8			18.8	

(1) Full range is 0°C to 70°C.

5.14 TLE2144C Operating Characteristics, $V_{CC\pm} = \pm 15V$, $T_A = 25^\circ C$

PARAMETER	TEST CONDITIONS	TLE2144C			TLE2144AC			UNIT
		MIN	TYP	MAX	MIN	TYP	MAX	
SR+	Positive slew rate	$A_{VD} = -1, R_L = 2k\Omega, C_L = 500pF$		27 ¹	45	27 ¹	45	V/ μs
SR-	Negative slew rate			27 ¹	42	27 ¹	42	
t_s	Settling time	$A_{VD} = -1, 10V$ step	To 0.1%	0.43		0.43		μs
			To 0.01%	0.64		0.64		
V_n	Equivalent input noise voltage	$R_S = 20\Omega, f = 10Hz$		15		15		nV/ \sqrt{Hz}
		$R_S = 20\Omega, f = 1kHz$		10.5		10.5		
$V_{N(PP)}$	Peak-to-peak equivalent input noise voltage	$f = 0.1Hz$ to 1Hz		0.48		0.48		μV
		$f = 0.1Hz$ to 10Hz		0.51		0.51		
I_n	Equivalent input noise current	$f = 10Hz$		1.89		1.89		pA/ \sqrt{Hz}
		$f = 1kHz$		0.47		0.47		
THD + N	Total harmonic distortion plus noise	$V_{O(PP)} = 20V, R_L = 2k\Omega, A_{VD} = 10, f = 10kHz$		0.06%		0.06%		
B_1	Unity-gain bandwidth	$R_L = 2k\Omega, C_L = 100pF$		6		6		MHz
	Gain-bandwidth product	$R_L = 2k\Omega, C_L = 100pF, f = 100kHz$		5.9		5.9		MHz
B_{OM}	Maximum output-swing bandwidth ⁽²⁾	$V_{O(PP)} = 2V, R_L = 2k\Omega, A_{VD} = 1, C_L = 100pF$		668		668		kHz
ϕ_m	Phase margin at unity gain	$R_L = 2k\Omega, C_L = 100pF$		58°		58°		

- (1) Specified by characterization.
 (2) Measured at -0.1dB.

5.15 TLE2141I Electrical Characteristics

at specified free-air temperature, $V_{CC} = 5V$ (unless otherwise noted)

PARAMETER	TEST CONDITIONS	T_A ⁽¹⁾	TLE2141I			TLE2141AI			UNIT
			MIN	TYP	MAX	MIN	TYP	MAX	
V_{IO} Input offset voltage		25°C	225	1400		200	1000	mV	
		Full range		1900		1500			
α_{VIO} Temperature coefficient of input offset voltage	$V_O = 2.5V, R_S = 50\Omega, V_{IC} = 2.5V$	Full range	1.7			1.7		$\mu V/^\circ C$	
I_{IO} Input offset current		25°C	8	100		8	100	nA	
		Full range		200		200			
I_{IB} Input bias current		25°C	-0.8	-2		-0.8	-2	μA	
		Full range		-2.2		-2.2			
V_{ICR} Common-mode input voltage range		$R_S = 50\Omega$	25°C	0 to 3	-0.3 to 3.2		0 to 3	-0.3 to 3.2	V
	Full range		0 to 2.7	-0.3 to 2.9		0 to 2.7	-0.3 to 2.9	V	
V_{OH} High-level output voltage	$I_{OH} = -150\mu A$	25°C	3.9	4.1		3.9	4.1	V	
	$I_{OH} = -1.5mA$		3.8	4		3.8	4		
	$I_{OH} = -15mA$		3.2	3.7		3.2	3.7		
	Full range	$I_{OH} = -100\mu A$	3.8			3.8		V	
		$I_{OH} = -1mA$	3.7			3.7			
		$I_{OH} = -10mA$	3.3			3.3			
V_{OL} Low-level output voltage	$I_{OL} = 150\mu A$	25°C	75	125		75	125	mV	
	$I_{OL} = 1.5mA$		150	225		150	225		
	$I_{OL} = 15mA$		1.2	1.6		1.2	1.6		
	Full range	$I_{OL} = 100\mu A$	175			175		mV	
		$I_{OL} = 1mA$	225			225			
		$I_{OL} = 10mA$	1.4			1.4			
A_{VD} Large-signal differential voltage amplification	$V_{CC} = \pm 2.5V, R_L = 2k\Omega, V_O = 1V \text{ to } -1.5V$	25°C	50	220		50	220	V/mV	
		Full range	10			10			
r_i Input resistance		25°C	70			70	$M\Omega$		
c_i Input capacitance		25°C	2.5			2.5	pF		
Z_o Open-loop output impedance	$f = 1MHz$	25°C	30			30	Ω		
CMRR Common-mode rejection ratio	$V_{IC} = V_{ICRmin}, R_S = 50\Omega$	25°C	85	118		85	118	dB	
		Full range	80			80			
k_{SVR} Supply-voltage rejection ratio ($\Delta V_{CC\pm} / \Delta V_{IO}$)	$V_{CC\pm} = \pm 2.5V \text{ to } \pm 15V, R_S = 50\Omega$	25°C	90	106		90	106	dB	
		Full range	85			85			
I_{CC} Supply current	$V_O = 2.5V, \text{ No load}, V_{IC} = 2.5V$	25°C	3.4	4.4		3.4	4.4	mA	
		Full range		4.6			4.6		

(1) Full range is $-40^\circ C$ to $105^\circ C$.

5.16 TLE2141I Operating Characteristics, $V_{CC} = 5V$, $T_A = 25^\circ C$

PARAMETER	TEST CONDITIONS	TLE2141I			TLE2141AI			UNIT		
		MIN	TYP	MAX	MIN	TYP	MAX			
SR+	Positive slew rate	$A_{VD} = -1, R_L = 2k\Omega^{(1)}, C_L = 500pF$						45	45	V/ μs
SR-	Negative slew rate							42	42	
t_s	Settling time	$A_{VD} = -1, 2.5V$ step		To 0.1%	0.66	0.66	μs			
				To 0.01%	0.99	0.99				
V_n	Equivalent input noise voltage	$R_S = 20\Omega, f = 10Hz$						15	15	nV/ \sqrt{Hz}
		$R_S = 20\Omega, f = 1kHz$						10.5	10.5	
$V_{N(PP)}$	Peak-to-peak equivalent input noise voltage	$f = 0.1Hz$ to $1Hz$						0.48	0.48	μV
		$f = 0.1Hz$ to $10Hz$						0.51	0.51	
I_n	Equivalent input noise current	$f = 10Hz$						1.92	1.92	pA/ \sqrt{Hz}
		$f = 1kHz$						0.5	0.5	
THD + N	Total harmonic distortion plus noise	$V_O = 1V$ to $3V, R_L = 2k\Omega^{(1)}$ $A_{VD} = 2, f = 10kHz$						0.0052%	0.0052%	
B_1	Unity-gain bandwidth	$R_L = 2k\Omega^{(1)}, C_L = 100pF^{(1)}$						5.9	5.9	MHz
	Gain-bandwidth product	$R_L = 2k\Omega^{(1)}, C_L = 100pF^{(1)}$ $f = 100kHz$						5.8	5.8	MHz
B_{OM}	Maximum output-swing bandwidth ⁽²⁾	$V_{O(PP)} = 2V, R_L = 2k\Omega^{(1)}$ $A_{VD} = 1, C_L = 100pF$						380	380	kHz
ϕ_m	Phase margin at unity gain	$R_L = 2k\Omega^{(1)}, C_L = 100pF^{(1)}$						57°	57°	

- (1) R_L and C_L terminated to 2.5V .
 (2) Measured at -0.1dB.

5.17 TLE2141I Electrical Characteristics

 at specified free-air temperature, $V_{CC\pm} = \pm 15V$ (unless otherwise noted)

PARAMETER	TEST CONDITIONS	T_A (1)	TLE2141I			TLE2141AI			UNIT
			MIN	TYP	MAX	MIN	TYP	MAX	
V_{IO} Input offset voltage		25°C		200	900		175	500	μV
		Full range			1500			1000	
α_{VIO} Temperature coefficient of input offset voltage	$V_{IC} = 0, R_S = 50\Omega, V_O = 0$	Full range		1.7			1.7		$\mu V/^\circ C$
I_{IO} Input offset current		25°C		7	100		7	100	nA
		Full range			200			200	
I_{IB} Input bias current		25°C		-0.7	-1.5		-0.7	-1.5	μA
	Full range			-1.7			-1.7		
V_{ICR} Common-mode input voltage range	$R_S = 50\Omega$	25°C	-15 to 13	-15.3 to 13.2		-15 to 13	-15.3 to 13.2	V	
		Full range	-15 to 12.7	15.3 to 12.9		-15 to 12.7	-15.3 to 12.9	V	
V_{OM+} Maximum positive peak output voltage swing		25°C	$I_O = -150\mu A$	13.8	14.1	13.8	14.1	V	
			$I_O = -1.5mA$	13.7	14	13.7	14		
			$I_O = -15mA$	13.1	13.7	13.1	13.7		
		Full range	$I_O = 100\mu A$	13.7		13.7			
			$I_O = 1mA$	13.6		13.6			
			$I_O = 10mA$	13.1		13.1			
V_{OM-} Maximum negative peak output voltage swing		25°C	$I_O = 150\mu A$	-14.7	-14.9	-14.7	-14.9	V	
			$I_O = 1.5mA$	-14.5	-14.8	-14.5	-14.8		
			$I_O = 15mA$	-13.4	-13.8	-13.4	-13.8		
		Full range	$I_O = 100\mu A$	-14.6		-14.6			
			$I_O = 1mA$	-14.5		-14.5			
			$I_O = 10mA$	-13.4		-13.4			
A_{VD} Large-signal differential voltage amplification	$V_O = \pm 10V, R_L = 2k\Omega$	25°C	100	450	100	450	V/mV		
		Full range	40		40				
r_i Input resistance		25°C		65		65	M Ω		
c_i Input capacitance		25°C		2.5		2.5	pF		
Z_o Open-loop output impedance	$f = 1MHz$	25°C		30		30	Ω		
CMRR Common-mode rejection ratio	$V_{IC} = V_{ICRmin}, R_S = 50\Omega$	25°C	85	108	85	108	dB		
		Full range	80		80				
k_{SVR} Supply-voltage rejection ratio ($\Delta V_{CC\pm} / \Delta V_{IO}$)	$V_{CC\pm} = \pm 2.5V$ to $\pm 15V, R_S = 50\Omega$	25°C	90	106	90	106	dB		
		Full range	85		85				
I_{OS} Short circuit output current	$V_O = 0$	25°C	$V_{ID} = 1V$	-25	-50	-25	-50	mA	
			$V_{ID} = -1V$	20	31	20	31		
I_{CC} Supply current	$V_O = 0V, \text{No load}$	25°C		3.5	4.5		3.5	4.5	mA
		Full range			4.7			4.7	

 (1) Full range is $-40^\circ C$ to $105^\circ C$.

5.18 TLE2141I Operating Characteristics, $V_{CC\pm} = \pm 15V$, $T_A = 25^\circ C$

PARAMETER	TEST CONDITIONS	TLE2141I			TLE2141AI			UNIT
		MIN	TYP	MAX	MIN	TYP	MAX	
SR+	Positive slew rate	$A_{VD} = -1, R_L = 2k\Omega, C_L = 500pF$		27 ⁽¹⁾	45	27 ⁽¹⁾	45	V/ μs
SR-	Negative slew rate			27 ⁽¹⁾	42	27 ⁽¹⁾	42	
t_s	Settling time	$A_{VD} = -1, 10V$ step	To 0.1%	0.43			μs	
			To 0.01%	0.64				
V_n	Equivalent input noise voltage	$R_S = 20\Omega, f = 10Hz$		15			nV/ \sqrt{Hz}	
		$R_S = 20\Omega, f = 1kHz$		10.5				
$V_{N(PP)}$	Peak-to-peak equivalent input noise voltage	$f = 0.1Hz$ to 1Hz		0.48			μV	
		$f = 0.1Hz$ to 10Hz		0.51				
I_n	Equivalent input noise current	$f = 10Hz$		1.89			pA/ \sqrt{Hz}	
		$f = 1kHz$		0.47				
THD + N	Total harmonic distortion plus noise	$V_{O(PP)} = 20V, R_L = 2k\Omega, A_{VD} = 10, f = 10kHz$		0.06%				
B_1	Unity-gain bandwidth	$R_L = 2k\Omega, C_L = 100pF$		6			MHz	
	Gain-bandwidth product	$R_L = 2k\Omega, C_L = 100pF, f = 100kHz$		5.9			MHz	
B_{OM}	Maximum output-swing bandwidth ⁽²⁾	$V_{O(PP)} = 2V, R_L = 2k\Omega, A_{VD} = 1, C_L = 100pF$		668			kHz	
ϕ_m	Phase margin at unity gain	$R_L = 2k\Omega, C_L = 100pF$		58°				

- (1) Specified by characterization.
- (2) Measured at -0.1dB.

5.19 TLE2142I Electrical Characteristics

 at specified free-air temperature, $V_{CC} = 5V$ (unless otherwise noted)

PARAMETER	TEST CONDITIONS	T_A ⁽¹⁾	TLE2142I			TLE2142AI			UNIT	
			MIN	TYP	MAX	MIN	TYP	MAX		
V_{IO} Input offset voltage		25°C		220	1900		220	1500	μV	
		Full range			2400			2000		
α_{VIO} Temperature coefficient of input offset voltage	$V_O = 2.5V, R_S = 50\Omega, V_{IC} = 2.5V$	Full range		1.7			1.7	$\mu V/^\circ C$		
I_{IO} Input offset current		25°C		8	100		8	100	nA	
		Full range			200			200		
I_{IB} Input bias current		25°C		-0.8	-2		-0.8	-2	μA	
	Full range			-2.2			-2.2			
V_{ICR} Common-mode input voltage range	$R_S = 50\Omega$	25°C	0 to 3	-0.3 to 3.2		0 to 3	-0.3 to 3.2	V		
		Full range	0 to 2.7	-0.3 to 2.9		0 to 2.7	-0.3 to 2.9	V		
V_{OH} High-level output voltage		25°C	$I_{OH} = -150\mu A$		13.8	14.1		13.8	14.1	V
			$I_{OH} = -1.5mA$		13.7	14		13.7	14	
			$I_{OH} = -15mA$		13.1	13.7		13.1	13.7	
		Full range	$I_{OH} = 100\mu A$		13.7			13.7		
			$I_{OH} = 1mA$		13.6			13.6		
			$I_{OH} = 10mA$		13.1			13.1		
V_{OL} Low-level output voltage		25°C	$I_{OL} = 150\mu A$		3.9	4.1		3.9	4.1	mV
			$I_{OL} = 1.5mA$		3.8	4		3.8	4	
			$I_{OL} = 15mA$		3.4	3.7		3.4	3.7	
		Full range	$I_{OL} = 100\mu A$		3.8			3.8		mV
			$I_{OL} = 1mA$		3.7			3.7		V
			$I_{OL} = 10mA$		3.5			3.5		V
A_{VD} Large-signal differential voltage amplification	$V_{IC} = \pm 2.5V, R_L = 2k\Omega, V_O = 1V \text{ to } -1.5V$	25°C		50	220		50	220	V/mV	
		Full range		10			10			
r_i Input resistance		25°C		70			70	M Ω		
c_i Input capacitance		25°C		2.5			2.5	pF		
Z_o Open-loop output impedance	$f = 1MHz$	25°C		30			30	Ω		
CMRR Common-mode rejection ratio	$V_{IC} = V_{ICRmin}, R_S = 50\Omega$	25°C		85	118		85	118	dB	
		Full range		80			80			
k_{SVR} Supply-voltage rejection ratio ($\Delta V_{CC\pm} / \Delta V_{IO}$)	$V_{CC\pm} = \pm 2.5V \text{ to } \pm 15V, R_S = 50\Omega$	25°C		90	106		90	106	dB	
		Full range		85			85			
I_{CC} Supply current	$V_O = 2.5V, V_{IC} = 2.5V, \text{ No load}$	25°C		6.6	8.8		6.6	8.8	mA	
		Full range			9.2			9.2		

 (1) Full range is $-40^\circ C$ to $105^\circ C$.

5.20 TLE2142I Operating Characteristics, $V_{CC} = 5V$, $T_A = 25^\circ C$

PARAMETER	TEST CONDITIONS	TLE2142I			TLE2142AI			UNIT		
		MIN	TYP	MAX	MIN	TYP	MAX			
SR+	Positive slew rate	$A_{VD} = -1$, $R_L = 2k\Omega^{(1)}$, $C_L = 500pF$						45	45	V/ μs
SR-	Negative slew rate							42	42	
t_s	Settling time	$A_{VD} = -1, 2.5V$ step	To 0.1%	0.66	0.66	μs				
			To 0.01%	0.99	0.99					
V_n	Equivalent input noise voltage	$R_S = 20\Omega$, $f = 10Hz$	15	15	nV/ \sqrt{Hz}					
		$R_S = 20\Omega$, $f = 1kHz$	10.5	10.5						
$V_{N(PP)}$	Peak-to-peak equivalent input noise voltage	$f = 0.1Hz$ to $1Hz$	0.48	0.48	μV					
		$f = 0.1Hz$ to $10Hz$	0.51	0.51						
I_n	Equivalent input noise current	$f = 10Hz$	1.92	1.92	pA/ \sqrt{Hz}					
		$f = 1kHz$	0.5	0.5						
THD + N	Total harmonic distortion plus noise	$V_O = 1V$ to $3V$, $R_L = 2k\Omega^{(1)}$, $A_{VD} = 2$, $f = 10kHz$			0.0052%	0.0052%				
B_1	Unity-gain bandwidth	$R_L = 2k\Omega^{(1)}$, $C_L = 100pF$						5.9	5.9	MHz
	Gain-bandwidth product	$R_L = 2k\Omega^{(1)}$, $C_L = 100pF$, $f = 100kHz$						5.8	5.8	MHz
B_{OM}	Maximum output-swing bandwidth ⁽²⁾	$V_{O(PP)} = 2V$, $R_L = 2k\Omega^{(1)}$, $A_{VD} = 1$, $C_L = 100pF$						380	380	kHz
ϕ_m	Phase margin at unity gain	$R_L = 2k\Omega^{(1)}$, $C_L = 100pF$						57°	57°	

- (1) R_L terminates at 2.5V .
 (2) Measured at -0.1dB.

5.21 TLE2142I Electrical Characteristics

at specified free-air temperature, $V_{CC\pm} = \pm 15V$ (unless otherwise noted)

PARAMETER	TEST CONDITIONS	T_A (1)	TLE2142I			TLE2142I			UNIT
			MIN	TYP	MAX	MIN	TYP	MAX	
V_{IO} Input offset voltage		25°C	290	1200		275	750	μV	
		Full range			1800		1400		
α_{VIO} Temperature coefficient of input offset voltage	$V_{IC} = 0, R_S = 50\Omega, V_O = 0$	Full range	1.7			1.7		$\mu V/^\circ C$	
I_{IO} Input offset current		25°C	7	100		7	100	nA	
		Full range			200		200		
I_{IB} Input bias current		25°C	-0.7	-1.5		-0.7	-1.5	μA	
	Full range			-1.7		-1.7			
V_{ICR} Common-mode input voltage range	$R_S = 50\Omega$	25°C	-15 to 13	-15.3 to 13.2		-15 to 13	-15.3 to 13.2	V	
		Full range	-15 to 12.7	15.3 to 12.9		-15 to 12.7	-15.3 to 12.9	V	
V_{OM+} Maximum positive peak output voltage swing		25°C	$I_O = -150\mu A$	13.8	14.1	13.8	14.1	V	
			$I_O = -1.5mA$	13.7	14	13.7	14		
			$I_O = -15mA$	13.3	13.7	13.3	13.7		
		Full range	$I_O = -100\mu A$	13.7	13.7	13.7	13.7	V	
			$I_O = -1mA$	13.6		13.6			
			$I_O = -10mA$	13.3		13.3			
V_{OM-} Maximum negative peak output voltage swing		25°C	$I_O = 150\mu A$	-14.7	-14.9	-14.7	-14.9	V	
			$I_O = 1.5mA$	-14.5	-14.8	-14.5	-14.8		
			$I_O = 15mA$	-13.4	-13.8	-13.4	-13.8		
		Full range	$I_O = 100\mu A$	-14.6		-14.6		V	
			$I_O = 1mA$	-14.5		-14.5			
			$I_O = 10mA$	-13.4		-13.4			
A_{VD} Large-signal differential voltage amplification	$V_O = \pm 10V, R_L = 2k\Omega$	25°C	100	450		100	450	V/mV	
		Full range	40			40			
r_i Input resistance		25°C	65			65	$M\Omega$		
c_i Input capacitance		25°C	2.5			2.5	pF		
Z_o Open-loop output impedance	$f = 1MHz$	25°C	30			30	Ω		
CMRR Common-mode rejection ratio	$V_{IC} = V_{ICRmin}$	25°C	85	108		85	108	dB	
	$R_S = 50\Omega$	Full range	80			80			
k_{SVR} Supply-voltage rejection ratio ($\Delta V_{CC\pm} / \Delta V_{IO}$)	$V_{CC\pm} = \pm 2.5V$ to $\pm 15V, R_S = 50\Omega$	25°C	90	106		90	106	dB	
		Full range	85			85			
I_{OS} Short circuit output current	$V_O = 0$	25°C	$V_{ID} = 1V$	-25	-50	-25	-50	mA	
			$V_{ID} = -1V$	20	31	20	31		
I_{CC} Supply current	$V_O = 0V, \text{No load}$	25°C	6.9	9		6.9	9	mA	
		Full range			9.4		9.4		

(1) Full range is $-40^\circ C$ to $105^\circ C$.

5.22 TLE2142I Operating Characteristics, $V_{CC\pm} = \pm 15V$, $T_A = 25^\circ C$

PARAMETER	TEST CONDITIONS	TLE2142I			TLE2142AI			UNIT
		MIN	TYP	MAX	MIN	TYP	MAX	
SR+	Positive slew rate	$A_{VD} = -1, R_L = 2k\Omega, C_L = 500pF$		30 ⁽¹⁾	45	30 ⁽¹⁾	45	V/ μ s
SR-	Negative slew rate			30 ⁵	42	30 ⁽¹⁾	42	
t_s	Settling time	$A_{VD} = -1, 10V$ step	To 0.1%	0.43		0.43		μ s
			To 0.01%	0.64		0.64		
V_n	Equivalent input noise voltage	$R_S = 20\Omega, f = 10Hz$		15		15		nV/ \sqrt{Hz}
		$R_S = 20\Omega, f = 1kHz$		10.5		10.5		
$V_{N(PP)}$	Peak-to-peak equivalent input noise voltage	$f = 0.1Hz$ to 1Hz		0.48		0.48		μ V
		$f = 0.1Hz$ to 10Hz		0.51		0.51		
I_n	Equivalent input noise current	$f = 10Hz$		1.89		1.89		pA/ \sqrt{Hz}
		$f = 1kHz$		0.47		0.47		
THD + N	Total harmonic distortion plus noise	$V_{O(PP)} = 20V, R_L = 2k\Omega, A_{VD} = 10, f = 10kHz$		0.06%		0.06%		
B_1	Unity-gain bandwidth	$R_L = 2k\Omega, C_L = 100pF$		6		6		MHz
	Gain-bandwidth product	$R_L = 2k\Omega, C_L = 100pF, f = 100kHz$		5.9		5.9		MHz
B_{OM}	Maximum output-swing bandwidth ⁽²⁾	$V_{O(PP)} = 2V, R_L = 2k\Omega, A_{VD} = 1, C_L = 100pF$		668		668		kHz
ϕ_m	Phase margin at unity gain	$R_L = 2k\Omega, C_L = 100pF$		58°		58°		

- (1) Specified by characterization.
- (2) Measured at -0.1dB.

5.23 TLE2144I Electrical Characteristics

at specified free-air temperature, $V_{CC} = 5V$ (unless otherwise noted)

PARAMETER	TEST CONDITIONS	T_A ⁽¹⁾	TLE2144I			TLE2144AI			UNIT
			MIN	TYP	MAX	MIN	TYP	MAX	
V_{IO} Input offset voltage		25°C	0.5		3.8	0.5		3	mV
		Full range			4.8			4	
α_{VIO} Temperature coefficient of input offset voltage	$V_O = 0, R_S = 50\Omega, V_O = 0$	Full range	1.7			1.7			$\mu V/^\circ C$
I_{IO} Input offset current		25°C	8		100	8		100	nA
		Full range			200			200	
I_{IB} Input bias current		25°C	-0.8		-2	-0.8		-2	μA
		Full range			-2.2			-2.2	
V_{ICR} Common-mode input voltage range		$R_S = 50\Omega$	25°C	0 to 3	-0.3 to 3.2		0 to 3	-0.3 to 3.2	V
	Full range		0 to 2.7	-0.3 to 2.9		0 to 2.7	-0.3 to 2.9	V	
V_{OH} High-level output voltage	$I_{OH} = -150\mu A$	25°C	3.9	4.1		3.9	4.1	V	
	$I_{OH} = -1.5mA$		3.8	4		3.8	4		
	$I_{OH} = -15mA$		3.4	3.7		3.4	3.7		
	Full range	$I_{OH} = 100\mu A$	3.8			3.8		V	
		$I_{OH} = 1mA$	3.7			3.7			
		$I_{OH} = 10mA$	3.5			3.5			
V_{OL} Low-level output voltage	$I_{OL} = 150\mu A$	25°C	75		125	75		125	mV
	$I_{OL} = 1.5mA$		150		225	150		225	
	$I_{OL} = 15mA$		1.2		1.6	1.2		1.6	
	Full range	$I_{OL} = 100\mu A$			175			175	mV
		$I_{OL} = 1mA$			225			225	
		$I_{OL} = 10mA$			1.4			1.4	
A_{VD} Large-signal differential voltage amplification	$V_{CC} = \pm 2.5V, R_L = 2k\Omega, V_O = 1V \text{ to } -1.5V$	25°C	50	95		50	95	V/mV	
		Full range	10			10			
r_i Input resistance		25°C	70			70		M Ω	
c_i Input capacitance		25°C	2.5			2.5		pF	
Z_o Open-loop output impedance	$f = 1MHz$	25°C	30			30		Ω	
CMRR Common-mode rejection ratio	$V_{IC} = V_{ICRmin}, R_S = 50\Omega$	25°C	85	118		85	118	dB	
		Full range	80			80			
k_{SVR} Supply-voltage rejection ratio ($\Delta V_{CC\pm} / \Delta V_{IO}$)	$V_{CC\pm} = \pm 2.5V \text{ to } \pm 15V, R_S = 50\Omega$	25°C	90	106		90	106	dB	
		Full range	85			85			
I_{CC} Supply current	$V_O = 2.5V, \text{ No load}, V_{IC} = 2.5V$	25°C	13.2	17.6		13.2	17.6	mA	
		Full range	18.4			18.4			

(1) Full range is -40°C to 105°C.

5.24 TLE2144C Operating Characteristics, $V_{CC} = 5V$, $T_A = 25^\circ C$

PARAMETER	TEST CONDITIONS	TLE2144C			TLE2144AC			UNIT
		MIN	TYP	MAX	MIN	TYP	MAX	
SR+	Positive slew rate	$A_{VD} = -1$, $R_L = 2k\Omega^{(1)}$, $C_L = 500pF$			45			V/ μs
SR-	Negative slew rate				42			
t_s	Settling time	$A_{VD} = -1$, 2.5V step		To 0.1%	0.66		μs	
				To 0.01%	0.99			
V_n	Equivalent input noise voltage	$R_S = 20\Omega$, $f = 10Hz$		15		nV/ \sqrt{Hz}		
		$R_S = 20\Omega$, $f = 1kHz$		10.5				
$V_{N(PP)}$	Peak-to-peak equivalent input noise voltage	$f = 0.1Hz$ to 1Hz		0.48		μV		
		$f = 0.1Hz$ to 10Hz		0.51				
I_n	Equivalent input noise current	$f = 10Hz$		1.92		pA/ \sqrt{Hz}		
		$f = 1kHz$		0.5				
THD + N	Total harmonic distortion plus noise	$V_O = 1V$ to 3V, $R_L = 2k\Omega^{(1)}$, $A_{VD} = 2$, $f = 10kHz$			0.0052%			
B_1	Unity-gain bandwidth	$R_L = 2k\Omega^{(1)}$, $C_L = 100pF$		5.9		MHz		
	Gain-bandwidth product	$R_L = 2k\Omega^{(1)}$, $C_L = 100pF$, $f = 100kHz$		5.8		MHz		
B_{OM}	Maximum output-swing bandwidth ⁽²⁾	$V_{O(PP)} = 2V$, $R_L = 2k\Omega^{(1)}$, $A_{VD} = 1$, $C_L = 100pF$		380		kHz		
ϕ_m	Phase margin at unity gain	$R_L = 2k\Omega^{(1)}$, $C_L = 100pF$		57°				

- (1) R_L terminated to 2.5V .
- (2) Measured at -0.1dB.

5.25 TLE2144I Electrical Characteristics

at specified free-air temperature, $V_{CC\pm} = \pm 15V$ (unless otherwise noted)

PARAMETER	TEST CONDITIONS	T_A ⁽¹⁾	TLE2144I			TLE2144AI			UNIT
			MIN	TYP	MAX	MIN	TYP	MAX	
V_{IO} Input offset voltage	$V_{IC} = 0, R_S = 50\Omega, V_O = 0$	25°C	0.6 2.4		0.5 1.5		μV		
		Full range	3.2		2.8				
α_{VIO} Temperature coefficient of input offset voltage		Full range	1.7		1.7		$\mu V/^\circ C$		
I_{IO} Input offset current		25°C	7 100		7 100		nA		
		Full range	200		200				
I_{IB} Input bias current		25°C	-0.7 -1.5		-0.7 -1.5		μA		
	Full range	-1.7		-1.7					
V_{ICR} Common-mode input voltage range	$R_S = 50\Omega$	25°C	-15 to 13	-15.3 to 13.2	-15 to 13	-15.3 to 13.2	V		
		Full range	-15 to 12.7	15.3 to 12.9	-15 to 12.7	-15.3 to 12.9	V		
V_{OM+} Maximum positive peak output voltage swing	$I_O = -150\mu A$ $I_O = -1.5mA$ $I_O = -15mA$ $I_O = -100\mu A$ $I_O = -1mA$ $I_O = -10mA$	25°C	13.8 14.1		13.8 14.1		V		
			13.7 14		13.7 14				
			13.1 13.7		13.1 13.7				
		Full range	13.7		13.7				
			13.6		13.6				
			13.1		13.1				
V_{OM-} Maximum negative peak output voltage swing	$I_O = 150\mu A$ $I_O = 1.5mA$ $I_O = 15mA$ $I_O = 100\mu A$ $I_O = 1mA$ $I_O = 10mA$	25°C	-14.7 -14.9		-14.7 -14.9		V		
			-14.5 -14.8		-14.5 -14.8				
			-13.4 -13.8		-13.4 -13.8				
		Full range	-14.6		-14.6				
			-14.5		-14.5				
			-13.4		-13.4				
A_{VD} Large-signal differential voltage amplification	$V_O = \pm 10V, R_L = 2k\Omega$	25°C	100 170		100 170		V/mV		
		Full range	40		40				
r_i Input resistance		25°C	65		65		M Ω		
c_i Input capacitance		25°C	2.5		2.5		pF		
Z_o Open-loop output impedance	$f = 1MHz$	25°C	30		30		Ω		
CMRR Common-mode rejection ratio	$V_{IC} = V_{ICRmin}$	25°C	85 108		85 108		dB		
	$R_S = 50\Omega$	Full range	80		80				
k_{SVR} Supply-voltage rejection ratio ($\Delta V_{CC\pm} / \Delta V_{IO}$)	$V_{CC\pm} = \pm 2.5V$ to $\pm 15V$, $R_S = 50\Omega$	25°C	90 106		90 106		dB		
		Full range	85		85				
I_{OS} Short circuit output current	$V_O = 0$	25°C	$V_{ID} = 1V$	-25 -50	-25 -50	mA			
			$V_{ID} = -1V$	20 31	20 31				
I_{CC} Supply current	$V_O = 0V$, No load	25°C	13.8 18		13.8 18		mA		
		Full range	18.8		18.8				

(1) Full range is $-40^\circ C$ to $105^\circ C$.

5.26 TLE2144I Operating Characteristics, $V_{CC\pm} = \pm 15V$, $T_A = 25^\circ C$

PARAMETER	TEST CONDITIONS	TLE2144I			TLE2144AI			UNIT
		MIN	TYP	MAX	MIN	TYP	MAX	
SR+	Positive slew rate	$A_{VD} = -1, R_L = 2k\Omega, C_L = 500pF$						V/ μs
SR-	Negative slew rate							
t_s	Settling time	$A_{VD} = -1, 10V$ step	To 0.1%	0.43			μs	
			To 0.01%	0.64				
V_n	Equivalent input noise voltage	$R_S = 20\Omega, f = 10Hz$						nV/ \sqrt{Hz}
		$R_S = 20\Omega, f = 1kHz$						
$V_{N(PP)}$	Peak-to-peak equivalent input noise voltage	$f = 0.1Hz$ to $1Hz$						μV
		$f = 0.1Hz$ to $10Hz$						
I_n	Equivalent input noise current	$f = 10Hz$						pA/ \sqrt{Hz}
		$f = 1kHz$						
THD + N	Total harmonic distortion plus noise	$V_{O(PP)} = 20V, R_L = 2k\Omega, A_{VD} = 10, f = 10kHz$						0.06%
B_1	Unity-gain bandwidth	$R_L = 2k\Omega, C_L = 100pF$						MHz
	Gain-bandwidth product	$R_L = 2k\Omega, C_L = 100pF, f = 100kHz$						MHz
B_{OM}	Maximum output-swing bandwidth ⁽²⁾	$V_{O(PP)} = 20V, R_L = 2k\Omega, A_{VD} = 1, C_L = 100pF$						kHz
ϕ_m	Phase margin at unity gain	$R_L = 2k\Omega, C_L = 100pF$						58°

- (1) Specified by characterization.
- (2) Measured at -0.1dB.

5.27 TLE2141 Electrical Characteristics

at specified free-air temperature, $V_{CC} = 5V$ (unless otherwise noted)

PARAMETER	TEST CONDITIONS	T_A ⁽¹⁾	TLE2141M			TLE2141AM			UNIT
			MIN	TYP	MAX	MIN	TYP	MAX	
V_{IO} Input offset voltage		25°C	225		1400	200		1000	μV
		Full range			2100			1700	
α_{VIO} Temperature coefficient of input offset voltage	$V_O = 2.5V, R_S = 50\Omega, V_O = 2.5V$	Full range	1.7			1.7			$\mu V/^\circ C$
I_{IO} Input offset current		25°C	8		100	8		100	nA
		Full range			250			250	
I_{IB} Input bias current		25°C	-0.8		-2	-0.8		-2	μA
	Full range			-2.3			-2.3		
V_{ICR} Common-mode input voltage range	$R_S = 50\Omega$	25°C	0 to 3	-0.3 to 3.2		0 to 3	-0.3 to 3.2	V	
		Full range	0 to 2.7	-0.3 to 2.9		0 to 2.7	-0.3 to 2.9	V	
V_{OH} High-level output voltage	$I_{OH} = -150\mu A$	25°C	3.9	4.1		3.9	4.1	V	
	$I_{OH} = -1.5mA$		3.8	4		3.8	4		
	$I_{OH} = -15mA$		3.2	3.7		3.2	3.7		
	Full range	$I_{OH} = -100\mu A$	3.75			3.75		V	
		$I_{OH} = -1mA$	3.65			3.65			
		$I_{OH} = -10mA$	3.25			3.25			
V_{OL} Low-level output voltage	$I_{OL} = 150\mu A$	25°C	75	125		75	125	mV	
	$I_{OL} = 1.5mA$		150	225		150	225		
	$I_{OL} = 15mA$		1.2	1.4		1.2	1.4		
	Full range	$I_{OL} = 100\mu A$	200			200		mV	
		$I_{OL} = 1mA$	250			225			
		$I_{OL} = 10mA$	1.25			1.25			
A_{VD} Large-signal differential voltage amplification	$V_{CC} = \pm 2.5V, R_L = 2k\Omega, V_O = 1V \text{ to } -1.5V$	25°C	50	220		50	220	V/mV	
		Full range	5			5			
r_i Input resistance		25°C	70			70		M Ω	
c_i Input capacitance		25°C	2.5			2.5		pF	
Z_o Open-loop output impedance	$f = 1MHz$	25°C	30			30		Ω	
CMRR Common-mode rejection ratio	$V_{IC} = V_{ICRmin}, R_S = 50\Omega$	25°C	85	118		85	118	dB	
		Full range	80			80			
k_{SVR} Supply-voltage rejection ratio ($\Delta V_{CC\pm} / \Delta V_{IO}$)	$V_{CC\pm} = \pm 2.5V \text{ to } \pm 15V, R_S = 50\Omega$	25°C	90	106		90	106	dB	
		Full range	85			85			
I_{CC} Supply current	$V_O = 2.5V, \text{ No load}, V_{IC} = 2.5V$	25°C	3.4	4.4		3.4	4.4	mA	
		Full range		4.6			4.6		

(1) Full range is $-55^\circ C$ to $125^\circ C$.

5.28 TLE2141M Operating Characteristics, $V_{CC} = 5V$, $T_A = 25^\circ C$

PARAMETER	TEST CONDITIONS	TLE2141M			TLE2141AM			UNIT
		MIN	TYP	MAX	MIN	TYP	MAX	
SR+	Positive slew rate	$A_{VD} = -1$, $R_L = 2k\Omega$, ⁽¹⁾ $C_L = 500pF$ ⁽¹⁾			45			V/ μs
SR-	Negative slew rate				42			
t_s	Settling time	$A_{VD} = -1$, 2.5V step	To 0.1%	0.66			μs	
			To 0.01%	0.99				
V_n	Equivalent input noise voltage	$R_S = 20\Omega$, $f = 10Hz$			15			nV/ \sqrt{Hz}
		$R_S = 20\Omega$, $f = 1kHz$			10.5			
$V_{N(PP)}$	Peak-to-peak equivalent input noise voltage	$f = 0.1Hz$ to 1Hz			0.48			μV
		$f = 0.1Hz$ to 10Hz			0.51			
I_n	Equivalent input noise current	$f = 10Hz$			1.92			pA/ \sqrt{Hz}
		$f = 1kHz$			0.5			
THD + N	Total harmonic distortion plus noise	$V_O = 1V$ to 3V, $R_L = 2k\Omega$, ⁽¹⁾ $A_{VD} = 2$, $f = 10kHz$			0.0052%			
B_1	Unity-gain bandwidth	$R_L = 2k\Omega$ ⁽¹⁾ , $C_L = 100pF$ ⁽¹⁾			5.9			MHz
	Gain-bandwidth product	$R_L = 2k\Omega$ ⁽¹⁾ , $C_L = 100pF$, ⁽¹⁾ $f = 100kHz$			5.8			MHz
B_{OM}	Maximum output-swing bandwidth ⁽²⁾	$V_{O(PP)} = 2V$, $R_L = 2k\Omega$, ⁽¹⁾ $A_{VD} = 1$, $C_L = 100pF$ ⁽¹⁾			380			kHz
ϕ_m	Phase margin at unity gain	$R_L = 2k\Omega$ ⁽¹⁾ , $C_L = 100pF$ ⁽¹⁾			57°			

- (1) R_L and C_L terminated to 2.5V .
 (2) Measured at -0.1dB.

5.29 TLE2141M Electrical Characteristics

at specified free-air temperature, $V_{CC\pm} = \pm 15V$ (unless otherwise noted)

PARAMETER	TEST CONDITIONS	T_A (1)	TLE2141M			TLE2141AM			UNIT
			MIN	TYP	MAX	MIN	TYP	MAX	
V_{IO} Input offset voltage		25°C		200	900		175	500	μV
		Full range			1700			1200	
α_{VIO} Temperature coefficient of input offset voltage	$V_{IC} = 0, R_S = 50\Omega$	Full range		1.7			1.7	$\mu V/^\circ C$	
I_{IO} Input offset current		25°C		7	100		7	100	nA
		Full range			250			250	
I_{IB} Input bias current		25°C		-0.7	-1.5		-0.7	-1.5	μA
	Full range			-1.8			-1.8		
V_{ICR} Common-mode input voltage range	$R_S = 50\Omega$	25°C	-15 to 13	-15.3 to 13.2		-15 to 13	-15.3 to 13.2	V	
		Full range	-15 to 12.7	15.3 to 12.9		-15 to 12.7	-15.3 to 12.9	V	
V_{OM+} Maximum positive peak output voltage swing	$I_O = -150\mu A$ $I_O = -1.5mA$ $I_O = -15mA$	25°C		13.8	14.1		13.8	14.1	V
				13.7	14		13.7	14	
				13.1	13.7		13.1	13.7	
	Full range			13.7			13.7		V
				13.6			13.6		
				13.1			13.1		
V_{OM-} Maximum negative peak output voltage swing	$I_O = 150\mu A$ $I_O = 1.5mA$ $I_O = 15mA$	25°C		-14.7	-14.9		-14.7	-14.9	V
				-14.5	-14.8		-14.5	-14.8	
				-13.4	-13.8		-13.4	-13.8	
	Full range			-14.6			-14.6		V
				-14.5			-14.5		
				-13.4			-13.4		
A_{VD} Large-signal differential voltage amplification	$V_O = \pm 10V, R_L = 2k\Omega$	25°C		100	450		100	450	V/mV
		Full range		20			20		
r_i Input resistance		25°C		65			65	M Ω	
c_i Input capacitance		25°C		2.5			2.5	pF	
Z_o Open-loop output impedance	$f = 1MHz$	25°C		30			30	Ω	
CMRR Common-mode rejection ratio	$V_{IC} = V_{ICRmin}, R_S = 50\Omega$	25°C		85	108		85	108	dB
		Full range		80			80		
k_{SVR} Supply-voltage rejection ratio ($\Delta V_{CC\pm} / \Delta V_{IO}$)	$V_{CC\pm} = \pm 2.5V$ to $\pm 15V$, $R_S = 50\Omega$	25°C		90	106		90	106	dB
		Full range		85			85		
I_{OS} Short circuit output current	$V_O = 0$	25°C	$V_{ID} = 1V$	-25	-50		-25	-50	mA
			$V_{ID} = -1V$	20	31		20	31	
I_{CC} Supply current	$V_O = 0V, V_{IC} = 2.5V$, No load	25°C		3.5	4.5		3.5	4.5	mA
		Full range			4.7			4.7	

(1) Full range is $-55^\circ C$ to $125^\circ C$.

5.30 TLE2141M Operating Characteristics, $V_{CC\pm} = \pm 15V$, $T_A = 25^\circ C$

PARAMETER	TEST CONDITIONS	TLE2141M			TLE2141AM			UNIT
		MIN	TYP	MAX	MIN	TYP	MAX	
SR+	Positive slew rate	$A_{VD} = -1, R_L = 2k\Omega, C_L = 100pF$		27 ⁽¹⁾	45	27 ⁽¹⁾	45	V/ μs
SR-	Negative slew rate			27 ⁽¹⁾	42	27 ⁽¹⁾	42	
t_s	Settling time	$A_{VD} = -1, 10V$ step	To 0.1%	0.43			μs	
			To 0.01%	0.64				
V_n	Equivalent input noise voltage	$R_S = 20\Omega, f = 10Hz$		15			nV/ \sqrt{Hz}	
		$R_S = 20\Omega, f = 1kHz$		10.5				
$V_{N(PP)}$	Peak-to-peak equivalent input noise voltage	$f = 0.1Hz$ to 1Hz		0.48			μV	
		$f = 0.1Hz$ to 10Hz		0.51				
I_n	Equivalent input noise current	$f = 10Hz$		1.89			pA/ \sqrt{Hz}	
		$f = 1kHz$		0.47				
THD + N	Total harmonic distortion plus noise	$V_{O(PP)} = 20V, R_L = 2k\Omega, A_{VD} = 10, f = 10kHz$		0.06%				
B_1	Unity-gain bandwidth	$R_L = 2k\Omega, C_L = 100pF$		6			MHz	
	Gain-bandwidth product	$R_L = 2k\Omega, C_L = 100pF, f = 100kHz$		5.9			MHz	
B_{OM}	Maximum output-swing bandwidth ⁽²⁾	$V_{O(PP)} = 20V, R_L = 2k\Omega, A_{VD} = 1, C_L = 100pF$		668			kHz	
ϕ_m	Phase margin at unity gain	$R_L = 2k\Omega, C_L = 100pF$		58°				

- (1) Specified by characterization.
- (2) Measured at -0.1dB.

5.31 TLE2142M Electrical Characteristics

at specified free-air temperature, $V_{CC} = 5V$ (unless otherwise noted)

PARAMETER	TEST CONDITIONS	T_A (1)	TLE2142M			TLE2142AM			UNIT
			MIN	TYP	MAX	MIN	TYP	MAX	
V_{IO} Input offset voltage	$V_{IC} = 0, R_S = 50\Omega$	25°C	220		1900	200		1500	μV
		Full range	2600			2200			
α_{VIO} Temperature coefficient of input offset voltage		Full range	1.7			1.7			$\mu V/^\circ C$
I_{IO} Input offset current		25°C	8		100	8		100	nA
		Full range	200			200			
I_{IB} Input bias current		25°C	-0.8		-2	-0.8		-2	μA
	Full range	-2.3			-2.3				
V_{ICR} Common-mode input voltage range	$R_S = 50\Omega$	25°C	0 to 3	-0.3 to 3.2		0 to 3	-0.3 to 3.2	V	
		Full range	0 to 2.7	-0.3 to 2.9		0 to 2.7	-0.3 to 2.9	V	
V_{OM+} Maximum positive peak output voltage swing	$I_O = -150\mu A$	25°C	3.9		4.1	3.9		4.1	V
			3.8		4	3.8		4	
	Full range	$I_O = -15m A$	3.4		3.7	3.4		3.7	V
			3.75			3.75			
			3.65			3.65			
			3.45			3.45			
V_{OM-} Maximum negative peak output voltage swing	$I_O = 150\mu A$	25°C	75		125	75		125	mV
			150		225	150		225	
	Full range	$I_O = 15m A$	1.2		1.4	1.2		1.4	V
			200			200			
			250			250			
			125			125			
A_{VD} Large-signal differential voltage amplification	$V_{IC} = \pm 2.5V, R_L = 2k\Omega, V_O = 1V \text{ to } -1.5V$	25°C	50		220	50		220	V/mV
		Full range	5			5			
r_i Input resistance		25°C	70			70			M Ω
c_i Input capacitance		25°C	2.5			2.5			pF
Z_o Open-loop output impedance	$f = 1MHz$	25°C	30			30			Ω
CMRR Common-mode rejection ratio	$V_{IC} = V_{ICRmin}, R_S = 50\Omega$	25°C	85		118	85		118	dB
		Full range	80			80			
k_{SVR} Supply-voltage rejection ratio ($\Delta V_{CC\pm} / \Delta V_{IO}$)	$V_{CC\pm} = \pm 2.5V \text{ to } \pm 15V, R_S = 50\Omega$	25°C	90		106	90		106	dB
		Full range	85			85			
I_{OS} Short circuit output current	$V_O = 0$	25°C	$V_{ID} = 1V$		-25	-50		mA	
			$V_{ID} = -1V$		20	31			
I_{CC} Supply current	$V_O = 0V, V_{IC} = 2.5V, \text{ No load}$	25°C	6.6		8.8	6.6		8.8	mA
		Full range	9.2			9.2			

(1) Full range is $-55^\circ C$ to $125^\circ C$.

5.32 TLE2142M Operating Characteristics, $V_{CC} = 5V$, $T_A = 25^\circ C$

PARAMETER	TEST CONDITIONS	TLE2142M			TLE2142AM			UNIT		
		MIN	TYP	MAX	MIN	TYP	MAX			
SR+	Positive slew rate	$A_{VD} = -1, R_L = 2k\Omega^{(1)}, C_L = 500pF$						45	45	V/ μs
SR-	Negative slew rate							42	42	
t_s	Settling time	$A_{VD} = -1, 10V$ step	To 0.1%	0.66			0.66	μs		
			To 0.01%	0.99			0.99			
V_n	Equivalent input noise voltage	$R_S = 20\Omega, f = 10Hz$						15	15	nV/ \sqrt{Hz}
		$R_S = 20\Omega, f = 1kHz$						10.5	10.5	
$V_{N(PP)}$	Peak-to-peak equivalent input noise voltage	$f = 0.1Hz$ to 1Hz						0.48	0.48	μV
		$f = 0.1Hz$ to 10Hz						0.51	0.51	
I_n	Equivalent input noise current	$f = 10Hz$						1.92	1.92	pA/ \sqrt{Hz}
		$f = 1kHz$						0.5	0.5	
THD + N	Total harmonic distortion plus noise	$V_O = 1V$ to 3V, $R_L = 2k\Omega^{(1)}$, $A_{VD} = 2, f = 10kHz$						0.0052%	0.0052%	%
B_1	Unity-gain bandwidth	$R_L = 2k\Omega^{(1)}, C_L = 100pF$						5.9	5.9	MHz
	Gain-bandwidth product	$R_L = 2k\Omega^{(1)}, C_L = 100pF, f = 100kHz$						5.8	5.8	MHz
B_{OM}	Maximum output-swing bandwidth ⁽²⁾	$V_{O(PP)} = 2V, R_L = 2k\Omega^{(1)}$, $A_{VD} = 1, C_L = 100pF$						380	380	kHz
ϕ_m	Phase margin at unity gain	$R_L = 2k\Omega^{(1)}, C_L = 100pF$						57°	57°	

- (1) R_L terminates at 2.5V .
- (2) Measured at -0.1dB.

5.33 TLE2142M Electrical Characteristics

at specified free-air temperature, $V_{CC\pm} = \pm 15V$ (unless otherwise noted)

PARAMETER	TEST CONDITIONS	T_A (1)	TLE2142M			TLE2142AM			UNIT
			MIN	TYP	MAX	MIN	TYP	MAX	
V_{IO} Input offset voltage	$V_{IC} = 0, R_S = 50\Omega$	25°C	290	1200		275	750	μV	
		Full range			2000		1600		
α_{VIO} Temperature coefficient of input offset voltage		Full range	1.7			1.7		$\mu V/^\circ C$	
I_{IO} Input offset current		25°C	7	100		7	100	nA	
		Full range			250		250		
I_{IB} Input bias current		25°C	-0.7	-1.5		-0.7	-1.5	μA	
	Full range			-1.8		-1.8			
V_{ICR} Common-mode input voltage range	$R_S = 50\Omega$	25°C	-15 to 13	-15.3 to 13.2		-15 to 13	-15.3 to 13.2	V	
		Full range	-15 to 12.7	-15.3 to 12.9		-15 to 12.7	-15.3 to 12.9	V	
V_{OM+} Maximum positive peak output voltage swing	$I_O = -150\mu A$ $I_O = -1.5mA$ $I_O = -15mA$ $I_O = -100\mu A$ $I_O = -1mA$ $I_O = -10mA$	25°C	13.8	14.1		13.8	14.1	V	
			13.7	14		13.7	14		
			13.3	13.7		13.3	13.7		
		Full range	13.7			13.7		V	
			13.6			13.6			
			13.3			13.3			
V_{OM-} Maximum negative peak output voltage swing	$I_O = 150\mu A$ $I_O = 1.5mA$ $I_O = 15mA$ $I_O = 100\mu A$ $I_O = 1mA$ $I_O = 10mA$	25°C	-14.7	-14.9				V	
			-14.5	-14.8					
			-13.4	-13.8					
		Full range	-14.6			-14.6		V	
			-14.5			-14.5			
			-13.4			-13.4			
A_{VD} Large-signal differential voltage amplification	$V_O = \pm 10V, R_L = 2k\Omega$	25°C	100	450		100	450	V/mV	
		Full range	20			20			
r_i Input resistance		25°C	65			65	$M\Omega$		
c_i Input capacitance		25°C	2.5			2.5	pF		
Z_o Open-loop output impedance	$f = 1MHz$	25°C	30			30	Ω		
CMRR Common-mode rejection ratio	$V_{IC} = V_{ICRmin}, R_S = 50\Omega$	25°C	85	108		85	108	dB	
		Full range	80			80			
k_{SVR} Supply-voltage rejection ratio ($\Delta V_{CC\pm} / \Delta V_{IO}$)	$V_{CC\pm} = \pm 2.5V$ to $\pm 15V$, $R_S = 50\Omega$	25°C	90	106		90	106	dB	
		Full range	85			85			
I_{OS} Short circuit output current	$V_O = 0$	25°C	$V_{ID} = 1V$	-25	-50		-25	-50	mA
			$V_{ID} = -1V$	20	31		20	31	
I_{CC} Supply current	$V_O = 0V, V_{IC} = 2.5V$, No load	25°C	6.9	9		6.9	9	mA	
		Full range			9.4		9.4		

(1) Full range is $-55^\circ C$ to $125^\circ C$.

5.34 TLE2142M Operating Characteristics, $V_{CC\pm} = \pm 15V$, $T_A = 25^\circ C$

PARAMETER	TEST CONDITIONS	TLE2142M			TLE2142AM			UNIT
		MIN	TYP	MAX	MIN	TYP	MAX	
SR+	Positive slew rate	$A_{VD} = -1, R_L = 2k\Omega, C_L = 100pF$		27 ⁽¹⁾	45	27 ^s	45	V/ μs
SR-	Negative slew rate			27 ⁽¹⁾	42	27 ^s	42	
t_s	Settling time	$A_{VD} = -1, 10V$ step	To 0.1%	0.43			μs	
			To 0.01%	0.64				
V_n	Equivalent input noise voltage	$R_S = 20\Omega, f = 10Hz$		15			nV/ \sqrt{Hz}	
		$R_S = 20\Omega, f = 1kHz$		10.5				
$V_{N(PP)}$	Peak-to-peak equivalent input noise voltage	$f = 0.1Hz$ to 1Hz		0.48			μV	
		$f = 0.1Hz$ to 10Hz		0.51				
I_n	Equivalent input noise current	$f = 10Hz$		1.89			pA/ \sqrt{Hz}	
		$f = 1kHz$		0.47				
THD + N	Total harmonic distortion plus noise	$V_{O(PP)} = 20V, R_L = 2k\Omega, A_{VD} = 2, f = 10kHz$		0.06%				
B_1	Unity-gain bandwidth	$R_L = 2k\Omega, C_L = 100pF$		6			MHz	
	Gain-bandwidth product	$R_L = 2k\Omega, C_L = 100pF, f = 100kHz$		5.9			MHz	
B_{OM}	Maximum output-swing bandwidth ⁽²⁾	$V_{O(PP)} = 2V, R_L = 2k\Omega, A_{VD} = 1, C_L = 100pF$		668			kHz	
ϕ_m	Phase margin at unity gain	$R_L = 2k\Omega, C_L = 100pF$		58°				

- (1) Specified by characterization.
 (2) Measured at -0.1dB.

5.35 TLE2144M Electrical Characteristics

at specified free-air temperature, $V_{CC} = 5V$ (unless otherwise noted)

PARAMETER	TEST CONDITIONS	T_A ⁽¹⁾	TLE2144M			TLE2144AM			UNIT
			MIN	TYP	MAX	MIN	TYP	MAX	
V_{IO} Input offset voltage	$V_O = 2.5V, R_S = 50\Omega, V_{IC} = 2.5V$	25°C	0.5		3.8	0.5		3	mV
		Full range	5.2			4.4			
α_{VIO} Temperature coefficient of input offset voltage		Full range	1.7			1.7			$\mu V/^\circ C$
		25°C	8		100	8		100	
I_{IO} Input offset current		Full range	250			250			nA
		25°C	8	-0.	-2	-0.8		-2	
I_{IB} Input bias current	Full range	-2.3			-2.3			μA	
V_{ICR} Common-mode input voltage range	$R_S = 50\Omega$	25°C	0 to 3	-0.3 to 3.2		0 to 3	-0.3 to 3.2	V	
		Full range	0 to 2.7	-0.3 to 2.9		0 to 2.7	-0.3 to 2.9	V	
V_{OH} High-level output voltage	$I_{OH} = -150\mu A$	25°C	3.9		4.1	3.9		4.1	V
	$I_{OH} = -1.5mA$		3.8		4	3.8		4	
	$I_{OH} = -15mA$		3.4		3.7	3.4		3.7	
	$I_{OH} = 100\mu A$	Full range	3.75			3.75			
	$I_{OH} = 1mA$		3.65			3.65			
	$I_{OH} = 10mA$		3.45			3.45			
V_{OL} Low level output voltage	$I_{OL} = 150\mu A$	25°C	75		125	75		125	mV
	$I_{OL} = 1.5\mu A$		150		225	150		225	
	$I_{OL} = 15mA$		1.2		1.6	1.2		1.6	
	$I_{OL} = 100\mu A$	Full range	200			200			mV
	$I_{OL} = 1mA$		250			250			
	$I_{OL} = 10mA$		1.45			1.45			
A_{VD} Large-signal differential voltage amplification	$V_{IC} = \pm 2.5V, R_L = 2k\Omega, V_O = 1V \text{ to } -1.5V$	25°C	50		95	50		95	V/mV
		Full range	5			5			
r_i Input resistance		25°C	70			70			$M\Omega$
c_i Input capacitance		25°C	2.5			2.5			pF
z_o Open-loop output impedance	$f = 1MHz$	25°C	30			30			Ω
CMRR Common-mode rejection ratio	$V_{IC} = V_{ICRmin}, R_S = 50\Omega$	25°C	85		118	85		118	dB
		Full range	80			80			
k_{SVR} Supply-voltage rejection ratio ($\Delta V_{CC} \pm / \Delta V_{IO}$)	$V_{CC} \pm = \pm 2.5V \text{ to } \pm 15V, R_S = 50\Omega$	25°C	90		106	90		106	dB
		Full range	85			85			
I_{CC} Supply current	$V_O = 2.5V, \text{ No load}, V_{IC} = 2.5V$	25°C	13.2		17.6	13.2		17.6	mA
		Full range	18.4			18.4			

(1) Full range is $-55^\circ C$ to $125^\circ C$.

5.36 TLE2144M Operating Characteristics

$V_{CC} = 5V$, $T_A = 25^\circ C$

PARAMETER	TEST CONDITIONS	TLE2144M			TLE2144AM			UNIT
		MIN	TYP	MAX	MIN	TYP	MAX	
SR+ Positive slew rate	$A_{VD} = -1$, $R_L = 2k\Omega^{(1)}$, $C_L = 500pF$	45			45			V/ μs
SR- Negative slew rate		42			42			
t_s Settling time	$A_{VD} = -1$, 2.5V step	To 0.1%	0.66		0.66		μs	
		To 0.01%	0.99		0.99			
V_n Equivalent input noise voltage	$R_S = 20\Omega$, $f = 10Hz$	15			15			nV/ \sqrt{Hz}
	$R_S = 20\Omega$, $f = 1kHz$	10.5			10.5			
$V_{N(PP)}$ Peak-to-peak equivalent input noise voltage	$f = 0.1Hz$ to 1Hz	0.48			0.48			μV
	$f = 0.1Hz$ to 10Hz	0.51			0.51			
I_n Equivalent input noise current	$f = 10Hz$	1.92			1.92			pA/ \sqrt{Hz}
	$f = 1kHz$	0.5			0.5			
THD + N Total harmonic distortion plus noise	$V_O = 1V$ to 3V, $R_L = 2k\Omega^{(1)}$, $A_{VD} = 2$, $f = 10kHz$	0.0052%			0.0052%			
B_1 Unity-gain bandwidth	$R_L = 2k\Omega^{(1)}$, $C_L = 100pF$	5.9			5.9			MHz
Gain-bandwidth product	$R_L = 2k\Omega^{(1)}$, $C_L = 100pF$, $f = 100kHz$	5.8			5.8			MHz
B_{OM} Maximum output-swing bandwidth ⁽²⁾	$V_{O(PP)} = 2V$, $R_L = 2k\Omega^{(1)}$, $A_{VD} = 1$	380			380			kHz
ϕ_m Phase margin	$R_L = 2k\Omega^{(1)}$, $C_L = 100pF$	57°			57°			

- (1) R_L terminates at 2.5V .
- (2) Measured at -0.1dB.

5.37 TLE2144M Electrical Characteristics

at specified free-air temperature, $V_{CC\pm} = \pm 15V$ (unless otherwise noted)

PARAMETER	TEST CONDITIONS	T_A ⁽¹⁾	TLE2144M			TLE2144AM			UNIT	
			MIN	TYP	MAX	MIN	TYP	MAX		
V_{IO} Input offset voltage	$V_{IC} = 0, R_S = 50\Omega$	25°C	0.6		2.4	0.5		1.5	mV	
		Full range				3.2				
α_{VIO} Temperature coefficient of input offset voltage		Full range	1.7			1.7			$\mu V/^\circ C$	
		25°C	7		100	7		100	nA	
I_{IO} Input offset current		Full range	250			250				
		25°C	-0.7		-1.5	-0.7		-1.5		
I_{IB} Input bias current	Full range	-1.8			-1.8			μA		
V_{ICR} Common-mode input voltage range	$R_S = 50\Omega$	25°C	-15 to 13	-15.3 to 13.2		-15 to 13	-15.3 to 13.2	V		
		Full range	-15 to 12.7	-15.3 to 12.9		-15 to 12.7	-15.3 to 12.9			
V_{OM+} Maximum positive peak output voltage swing	$I_O = -150\mu A$	25°C	13.8		14.1	13.8		14.1	V	
			13.7		14	13.7		14		
	$I_O = -15mA$		13.1		13.7	13.1		13.7		
			13.7			13.7				
	$I_O = -100\mu A$		Full range	13.6			13.6			
				13.1			13.1			
V_{OM-} Maximum negative peak output voltage swing	$I_O = 150\mu A$	25°C	-14.7		-14.9	-14.7		-14.9	V	
			-14.5		-14.8	-14.5		-14.8		
	$I_O = 1.5mA$		-13.4		-13.8	-13.4		-13.8		
			-14.6			-14.6				
	$I_O = 100\mu A$		Full range	-14.5			-14.5			
				-13.4			-13.4			
$I_O = 1mA$	Full range	100		170	100		170	V/mV		
		20			20					
r_i Input resistance		25°C	65			65			M Ω	
c_i Input capacitance		25°C	2.5			2.5			pF	
Z_o Open-loop output impedance	$f = 1MHz$	25°C	30			30			Ω	
CMR R Common-mode rejection ratio	$V_{IC} = V_{ICRmin}, R_S = 50\Omega$	25°C	85		108	85		108	dB	
		Full range	80			80				
k_{SVR} Supply-voltage rejection ratio ($\Delta V_{CC} \pm / \Delta V_{IO}$)	$V_{CC\pm} = \pm 2.5V$ to $\pm 15V, R_S = 50\Omega$	25°C	90		106	90		106	dB	
		Full range	85			85				
I_{OS} Short circuit output current	$V_O = 0$	25°C	$V_{ID} = 1V$		-25	-50		mA		
			$V_{ID} = -1V$		20	31				
I_{CC} Supply current	$V_O = 0, \text{ No load, } V_{IC} = 2.5V$	25°C	13.8		18	13.8		18	mA	
		Full range	18.8			18.8				

(1) Full range is -55°C to 125°C

5.38 TLE2144M Operating Characteristics

$V_{CC\pm} = \pm 15V$, $T_A = 25^\circ C$

PARAMETER	TEST CONDITIONS	TLE2144M			TLE2144AM			UNIT
		MIN	TYP	MAX	MIN	TYP	MAX	
SR+ Positive slew rate	$R_L = 2k\Omega$, $A_{VD} = -1$, $C_L = 100pF$	27 ⁽¹⁾	45		27 ⁽¹⁾	45		V/ μs
SR- Negative slew rate		27 ⁽¹⁾	42		27 ⁽¹⁾	42		
t_s Settling time	$A_{VD} = -1$, 10V step	To 0.1%	0.43		0.43		μs	
		To 0.01%	0.64		0.64			
V_n Equivalent input noise voltage	$R_S = 20\Omega$, $f = 10Hz$	15		15		nV/ \sqrt{Hz}		
	$R_S = 20\Omega$, $f = 1kHz$	10.5		10.5				
$V_{N(PP)}$ Peak-to-peak equivalent input noise voltage	$f = 0.1Hz$ to 1Hz	0.48		0.48		μV		
	$f = 0.1Hz$ to 10Hz	0.51		0.51				
I_n Equivalent input noise current	$f = 10Hz$	1.89		1.89		pA/ \sqrt{Hz}		
	$f = 10kHz$	0.47		0.47				
THD+N Total harmonic distortion plus noise	$V_{O(PP)} = 20V$, $R_L = 2k\Omega$, $A_{VD} = 10$, $f = 10kHz$	0.06%		0.06%				
B_1 Unity-gain bandwidth	$R_L = 2k\Omega$, $C_L = 100pF$	6		6		MHz		
Gain-bandwidth product	$R_L = 2k\Omega$, $C_L = 100pF$, $f = 100kHz$	5.9		5.9		MHz		
B_{OM} Maximum output-swing bandwidth ⁽²⁾	$V_{O(PP)} = 20V$, $R_L = 2k\Omega$, $A_{VD} = 1$, $C_L = 100pF$	668		668		kHz		
ϕ_m Phase margin at unity gain	$R_L = 2k\Omega$, $C_L = 100pF$	58°		58°				

(1) Specified by characterization.

(2) Measured at -0.1dB.

5.39 TLE2141Y Electrical Characteristics

 at specified free-air temperature, $V_{CC\pm} = \pm 15V$, $T_A = 25^\circ C$ (unless otherwise noted)

PARAMETER	TEST CONDITIONS	TLE2141Y			UNIT
		MIN	TYP	MAX	
V_{IO} Input offset voltage			200	1000	μV
I_{IO} Input offset current	$V_{IC} = 0, R_S = 50\Omega, V_O = 0$		7	100	nA
I_{IB} Input bias current			-0.7	-1.5	μA
V_{ICR} Common-mode input voltage range	$R_S = 50\Omega$	-15 to 13	-15.3 to 13.2		V
V_{OM+} Maximum positive peak output voltage swing	$I_O = -150\mu A$	13.8	14.1		V
	$I_O = -1.5mA$	13.7	14		
	$I_O = -15mA$	13.3	13.7		
V_{OM-} Maximum negative peak output voltage swing	$I_O = 150\mu A$	-14.7	-14.9		V
	$I_O = 1.5mA$	-14.5	-14.8		
	$I_O = 15mA$	-13.4	-13.8		
A_{VD} Large-signal differential voltage amplification	$V_O = \pm 10V, R_L = 2k\Omega$	100	450		V/mV
r_i Input resistance			65		$M\Omega$
c_i Input capacitance			2.5		pF
Z_o Open-loop output impedance	$f = 1MHz$		30		Ω
CMRR Common-mode rejection ratio	$V_{IC} = V_{ICRmin}, R_S = 50\Omega$	80	108		dB
k_{SVR} Supply-voltage rejection ratio ($\Delta V_{CC} \pm / \Delta V_{IO}$)	$V_{CC\pm} = \pm 2.5V$ to $\pm 15V, R_S = 50\Omega$	85	106		dB
I_{OS} Short-circuit output current	$V_O = 0$	$V_{ID} = 1V$	-25	-50	mA
		$V_{ID} = -1V$	20	31	
I_{CC} Supply current	$V_O = 0, \text{No load}$	3.5	4.5		mA

5.40 TLE2142Y Electrical Characteristics

at specified free-air temperature, $V_{CC\pm} = \pm 15V$, $T_A = 25^\circ$ (unless otherwise noted)

PARAMETER	TEST CONDITIONS	TLE2142Y			UNIT
		MIN	TYP	MAX	
V_{IO} Input offset voltage			150	875	μV
I_{IO} Input offset current	$V_{IC} = 0, R_S = 50\Omega, V_O = 0$		7	100	nA
I_{IB} Input bias current			-0.7	-1.5	μA
V_{ICR} Common-mode input voltage range	$R_S = 50\Omega$	-15 to 13	-15.3 to 13.2		V
V_{OM+} Maximum positive peak output voltage swing	$I_O = -150\mu A$	13.8	14.1		V
	$I_O = -1.5mA$	13.7	14		
	$I_O = -15mA$	13.3	13.7		
V_{OM-} Maximum negative peak output voltage swing	$I_O = 150\mu A$	-14.7	-14.9		V
	$I_O = 1.5mA$	-14.5	-14.8		
	$I_O = 15mA$	-13.4	-13.8		
A_{VD} Large-signal differential voltage amplification	$V_O = \pm 10V, R_L = 2k\Omega$	100	450		V/mV
r_i Input resistance			65		M Ω
c_i Input capacitance			2.5		pF
Z_o Open-loop output impedance	$f = 1MHz$		30		Ω
CMRR Common-mode rejection ratio	$V_{IC} = V_{ICRmin}, R_S = 50\Omega$	80	108		dB
k_{SVR} Supply-voltage rejection ratio ($\Delta V_{CC} \pm / \Delta V_{IO}$)	$V_{CC\pm} = \pm 2.5V$ to $\pm 15V, R_S = 50\Omega$	85	106		dB
I_{OS} Short-circuit output current	$V_O = 0$	$V_{ID} = 1V$	-25	-50	mA
		$V_{ID} = -1V$	20	31	
I_{CC} Supply current	$V_O = 0, \text{No load}$		6.9	9	mA

5.41 TLE2144Y Electrical Characteristics

 at $V_{CC\pm} = \pm 15V$, $T_A = 25^\circ C$ (unless otherwise noted)

PARAMETER	TEST CONDITIONS	TLE2144Y			UNIT
		MIN	TYP	MAX	
V_{IO} Input offset voltage			0.3	1.8	μV
I_{IO} Input offset current	$V_{IC} = 0, R_S = 50\Omega, V_O = 0$		7	100	nA
I_{IB} Input bias current			-0.7	-1.5	μA
V_{ICR} Common-mode input voltage range	$R_S = 50\Omega$	-15 to 13	-15.3 to 13.2		V
V_{OM+} Maximum positive peak output voltage swing	$I_O = -150\mu A$	13.8	14.1		V
	$I_O = -1.5mA$	13.7	14		
	$I_O = -15mA$	13.3	13.7		
V_{OM-} Maximum negative peak output voltage swing	$I_O = 150\mu A$	-14.7	-14.9		V
	$I_O = 1.5mA$	-14.5	-14.8		
	$I_O = 15mA$	-13.4	-13.8		
A_{VD} Large-signal differential voltage amplification	$V_O = \pm 10V, R_L = 2k\Omega$	100	450		V/mV
r_i Input resistance			65		M Ω
c_i Input capacitance			2.5		pF
Z_o Open-loop output impedance	$f = 1MHz$		30		Ω
CMRR Common-mode rejection ratio	$V_{IC} = V_{ICRmin}, R_S = 50\Omega$	80	108		dB
k_{SVR} Supply-voltage rejection ratio ($\Delta V_{CC} \pm / \Delta V_{IO}$)	$V_{CC\pm} = \pm 2.5V$ to $\pm 15V, R_S = 50\Omega$	85	106		dB
I_{OS} Short-circuit output current	$V_O = 0$	$V_{ID} = 1V$	-25	-50	mA
		$V_{ID} = -1V$	20	31	
I_{CC} Supply current	$V_O = 0, \text{No load}$		13.8	18	mA

5.42 Typical Characteristics

Table of Graphs

			FIGURE
V_{IO}	Input offset voltage	Distribution	1, 2, 3
I_{IO}	Input offset current	vs Free-air temperature	4
I_{IB}	Input bias current	vs Common-mode input voltage	5
		vs Free-air temperature	6
V_{OM+}	Maximum positive peak output voltage	vs Supply voltage	7
		vs Free-air temperature	8
		vs Output current	9
		vs Settling time	11
V_{OM-}	Maximum negative peak output voltage	vs Supply voltage	7
		vs Free-air temperature	8
		vs Output current	10
		vs Settling time	11
$V_{O(PP)}$	Maximum peak-to-peak output voltage	vs Frequency	12
V_{OH}	High-level output voltage	vs Output current	13
V_{OL}	Low-level output voltage	vs Output current	14
A_{VD}	Large-signal differential voltage amplification	vs Frequency	15
		vs Free-air temperature	16
	Phase shift	vs Frequency	15
Z_o	Closed-loop output impedance	vs Frequency	17
I_{OS}	Short-circuit output current	vs Free-air temperature	18
CMRR	Common-mode rejection ratio	vs Frequency	19
		vs Free-air temperature	20
k_{SVR}	Supply-voltage rejection ratio	vs Frequency	21
		vs Free-air temperature	22
		vs Supply voltage	23
I_{CC}	Supply current	vs Free-air temperature	24
V_n	Equivalent input noise voltage	vs Frequency	25
V_n	Input noise voltage	Over a 10-second period	26
I_n	Noise current	vs Frequency	27
THD + N	Total harmonic distortion plus noise	vs Frequency	28
SR	Slew rate	vs Free-air temperature	29
		vs Load capacitance	30
Pulse response	Noninverting large signal	vs Time	31
	Inverting large signal	vs Time	32
	Small signal	vs Time	33
B_1	Unity-gain bandwidth	vs Load capacitance	34
	Gain margin	vs Load capacitance	35
ϕ_m	Phase margin	vs Load capacitance	36

5.42 Typical Characteristics (continued)

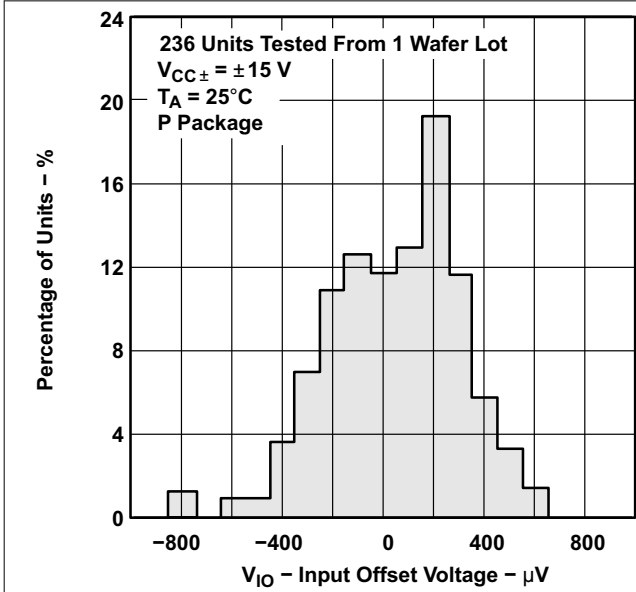

Figure 5-1. TLE2141 Distribution of Input Offset Voltage

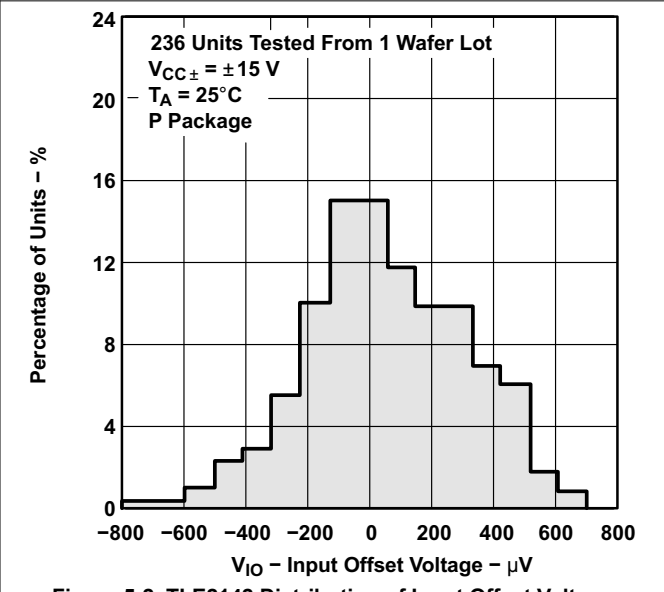
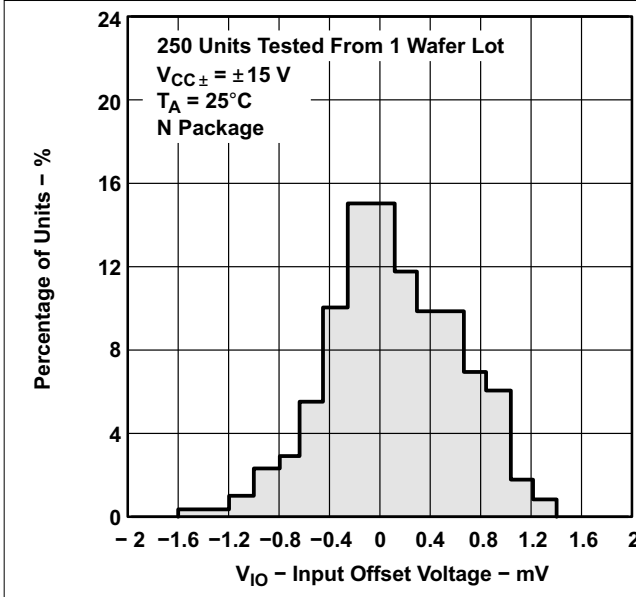
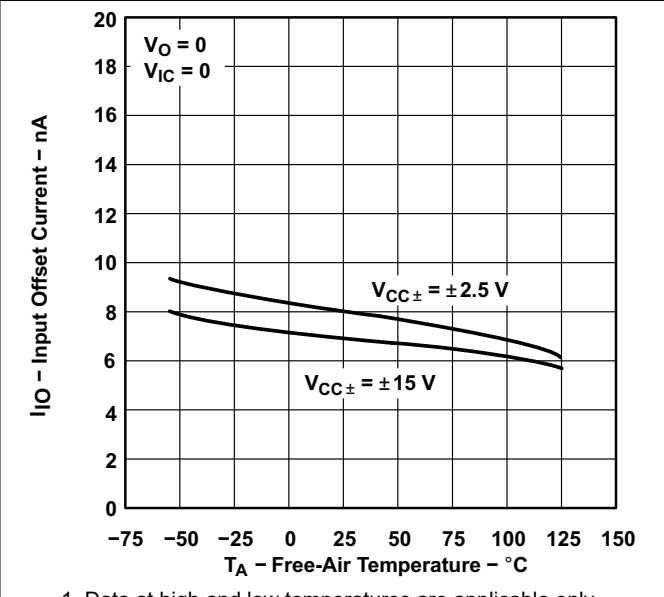

Figure 5-2. TLE2142 Distribution of Input Offset Voltage



TEST To remove kickback errors

Figure 5-3. TLE2144 Distribution of Input Offset Voltage



1. Data at high and low temperatures are applicable only within the rated operating free-air temperature ranges of the various devices.

Figure 5-4. Input Offset Current⁽¹⁾ Offset Voltage

5.42 Typical Characteristics (continued)

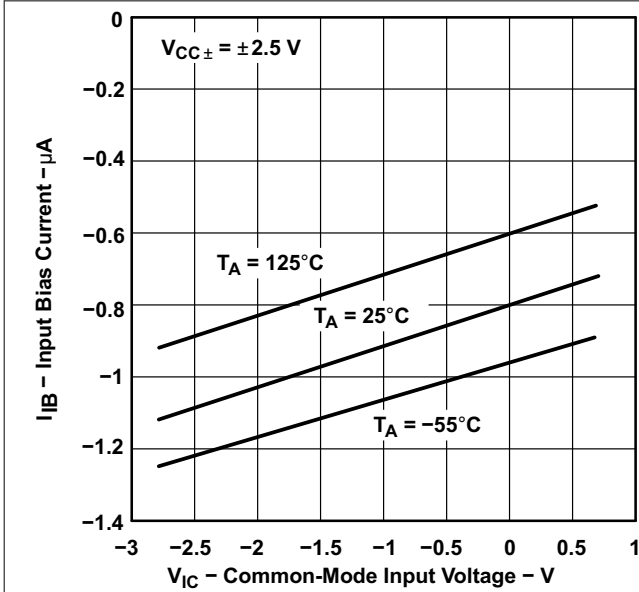

1. Data at high and low temperatures are applicable only within the rated operating free-air temperature ranges of the various devices.

Figure 5-5. Input Bias Current⁽¹⁾ vs Common-Mode Input Voltage

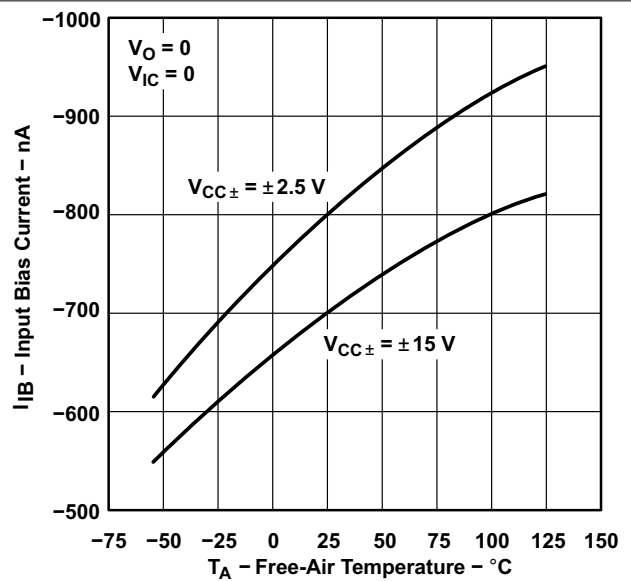

1. Data at high and low temperatures are applicable only within the rated operating free-air temperature ranges of the various devices.

Figure 5-6. Input Bias Current⁽¹⁾ vs Free-Air Temperature

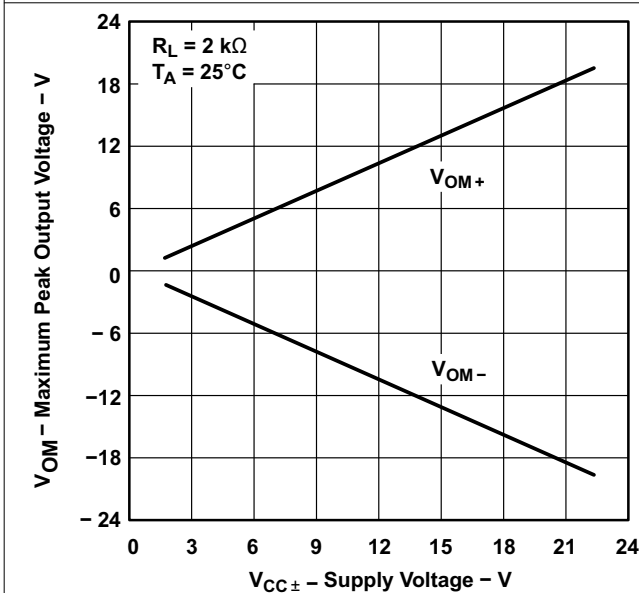

Figure 5-7. Maximum Peak Output Voltage vs Supply Voltage

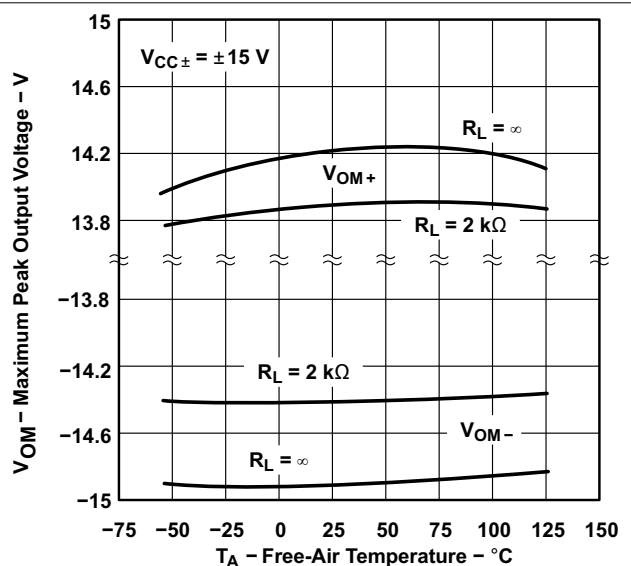
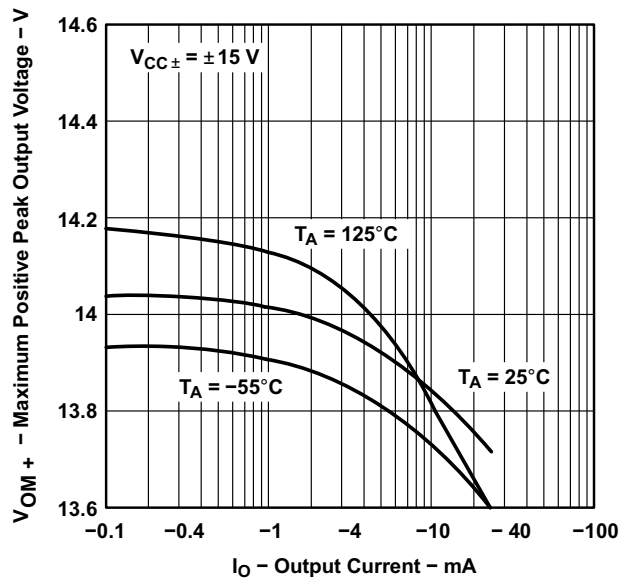

Figure 5-8. Maximum Peak Output Voltage vs Free-Air Temperature

5.42 Typical Characteristics (continued)



1. Data at high and low temperatures are applicable only within the rated operating free-air temperature ranges of the various devices.

Figure 5-9. Maximum Positive Peak Output Voltage⁽¹⁾ vs Output Current

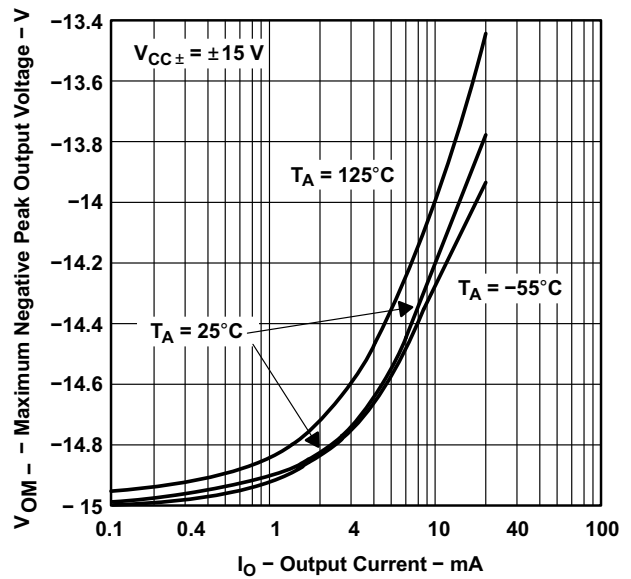

1. Data at high and low temperatures are applicable only within the rated operating free-air temperature ranges of the various devices.

Figure 5-10. Maximum Negative Peak Output Voltage⁽¹⁾ vs Output Current

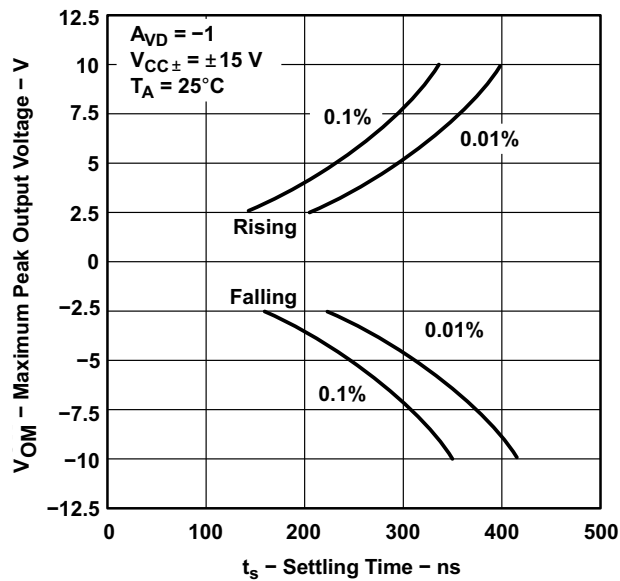
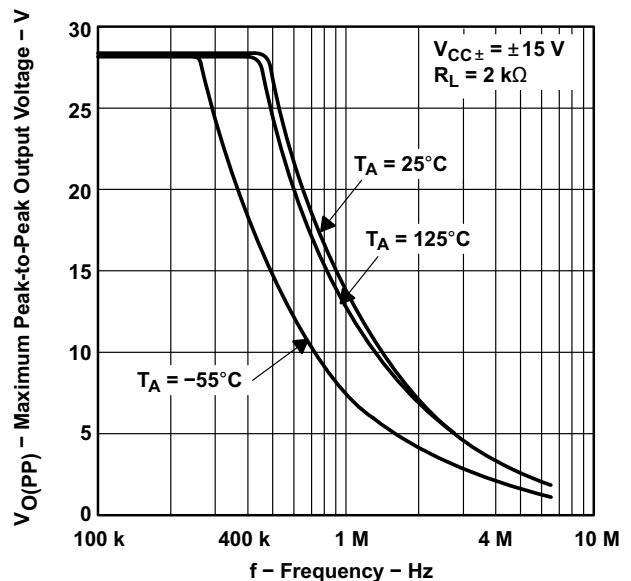

Figure 5-11. Maximum Peak Output Voltage vs Settling Time



1. Data at high and low temperatures are applicable only within the rated operating free-air temperature ranges of the various devices.

Figure 5-12. Maximum Peak-to-Peak Output Voltage⁽¹⁾ vs Frequency

5.42 Typical Characteristics (continued)

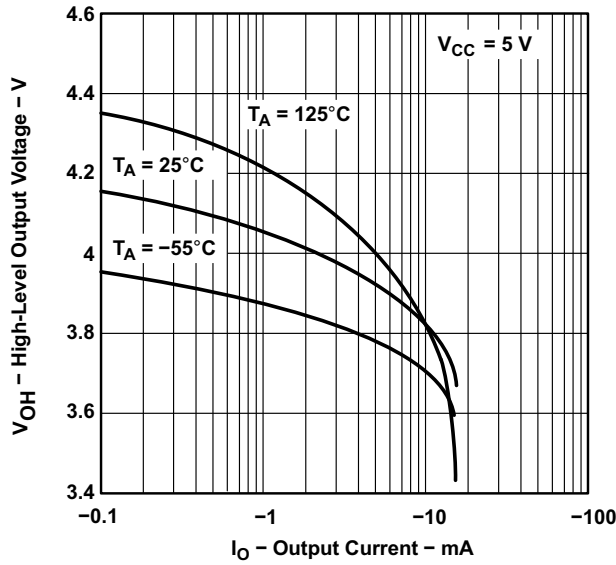

1. Data at high and low temperatures are applicable only within the rated operating free-air temperature ranges of the various devices.

Figure 5-13. High-Level Output Voltage⁽¹⁾ vs Output Current

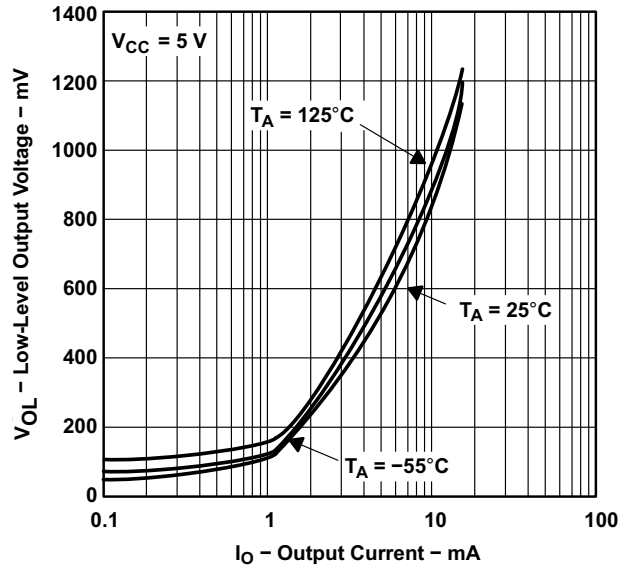

1. Data at high and low temperatures are applicable only within the rated operating free-air temperature ranges of the various devices.

Figure 5-14. Low-Level Output Voltage⁽¹⁾ vs Output Current

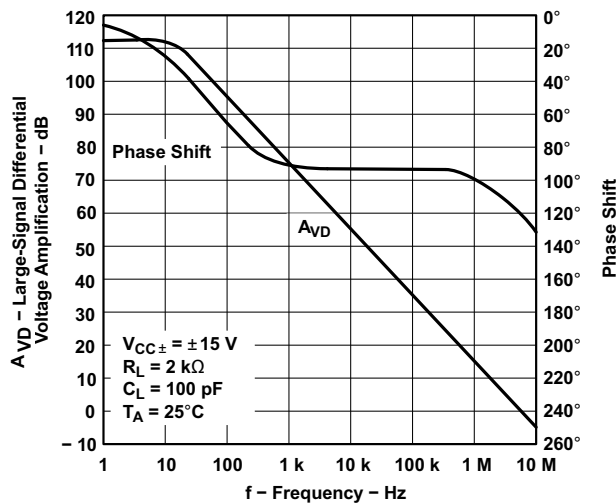
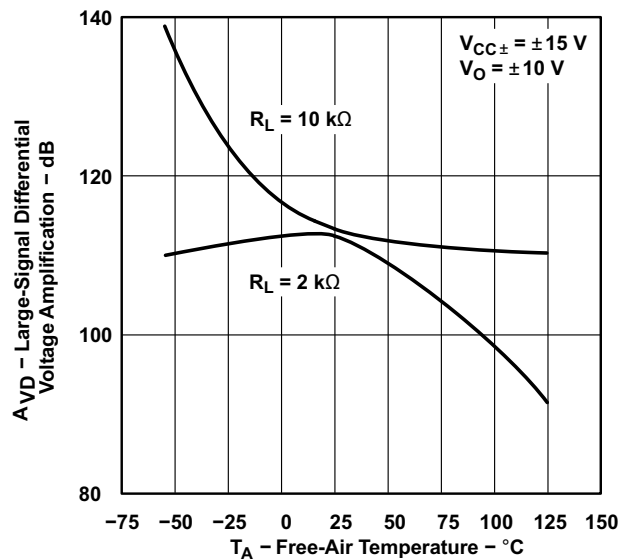

Figure 5-15. Large-Signal Differential Voltage Amplification and Phase Shift vs Frequency



1. Data at high and low temperatures are applicable only within the rated operating free-air temperature ranges of the various devices.

Figure 5-16. Large-Signal Differential Voltage Amplification⁽¹⁾ vs Free-Air Temperature

5.42 Typical Characteristics (continued)

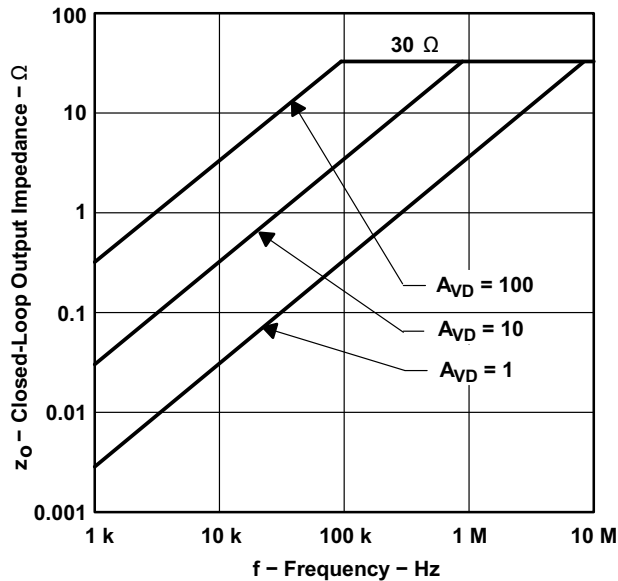
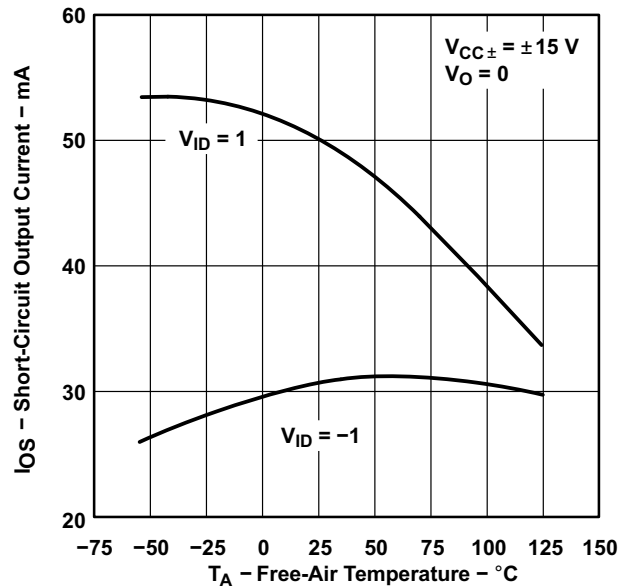

Figure 5-17. Closed-Loop Output Impedance vs Frequency



1. Data at high and low temperatures are applicable only within the rated operating free-air temperature ranges of the various devices.

Figure 5-18. Short-Circuit Output Current⁽¹⁾ vs Free-Air Temperature

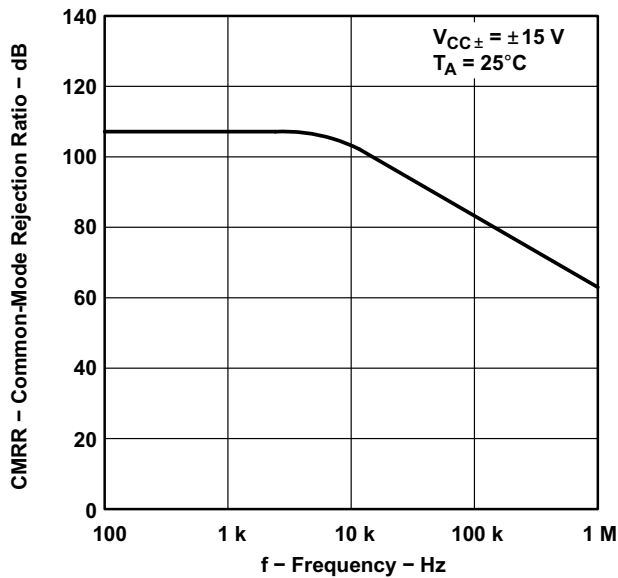
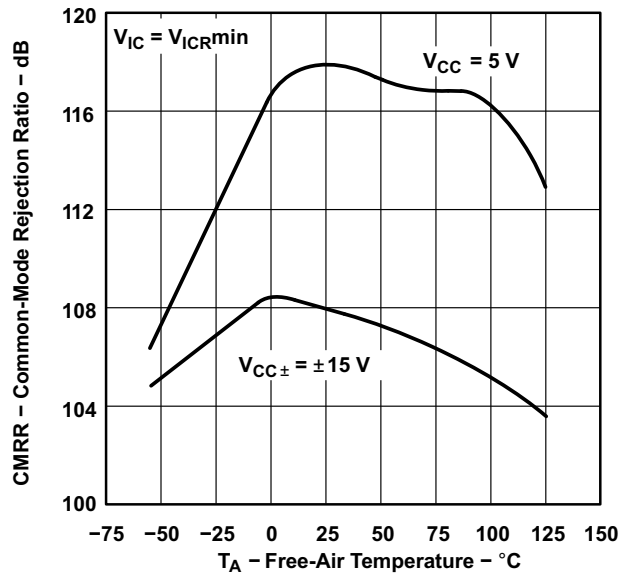

Figure 5-19. Common-Mode Rejection Ratio vs Frequency



1. Data at high and low temperatures are applicable only within the rated operating free-air temperature ranges of the various devices.

Figure 5-20. Common-Mode Rejection Ratio⁽¹⁾ vs Free-Air Temperature

5.42 Typical Characteristics (continued)

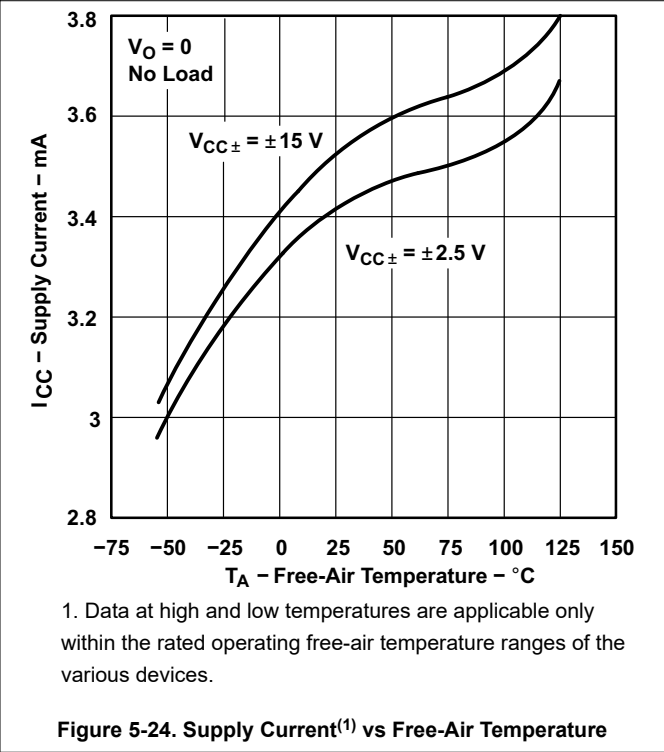
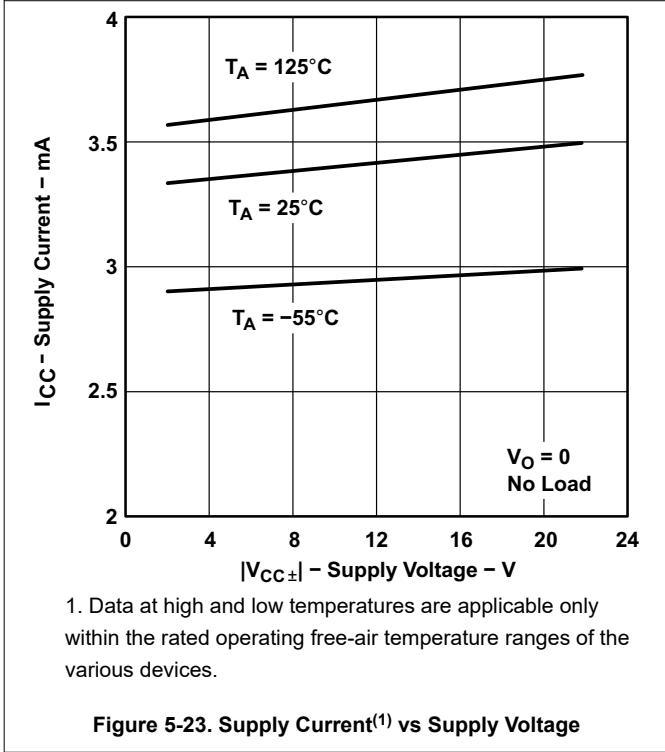
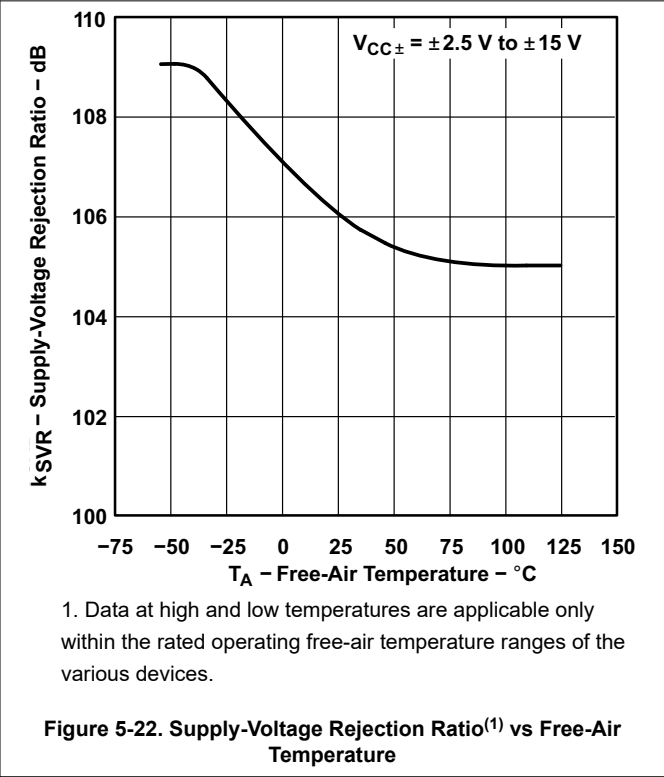
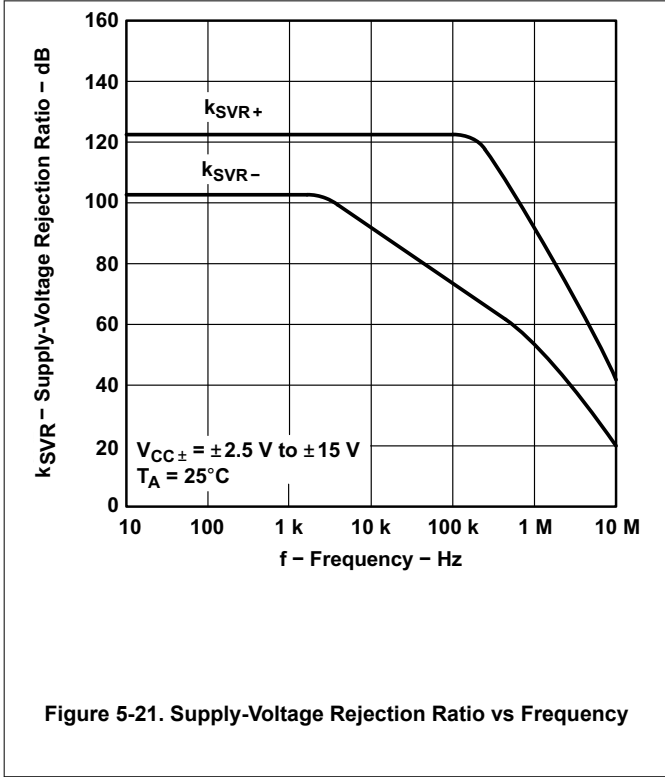

5.42 Typical Characteristics (continued)

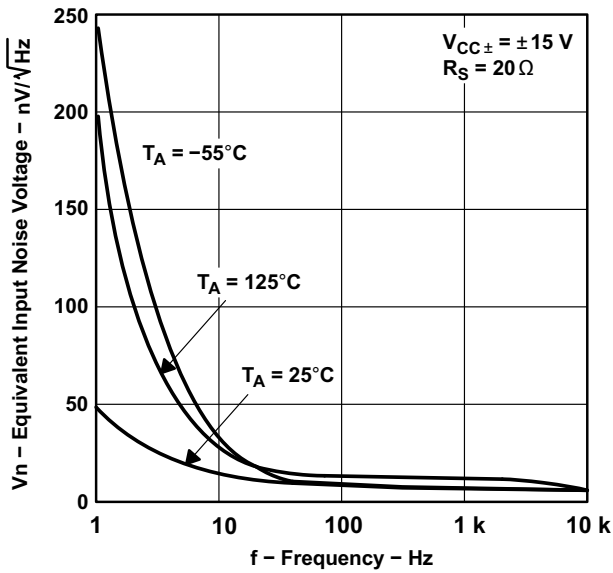

1. Data at high and low temperatures are applicable only within the rated operating free-air temperature ranges of the various devices.

Figure 5-25. Equivalent Input Noise Voltage⁽¹⁾ vs Frequency

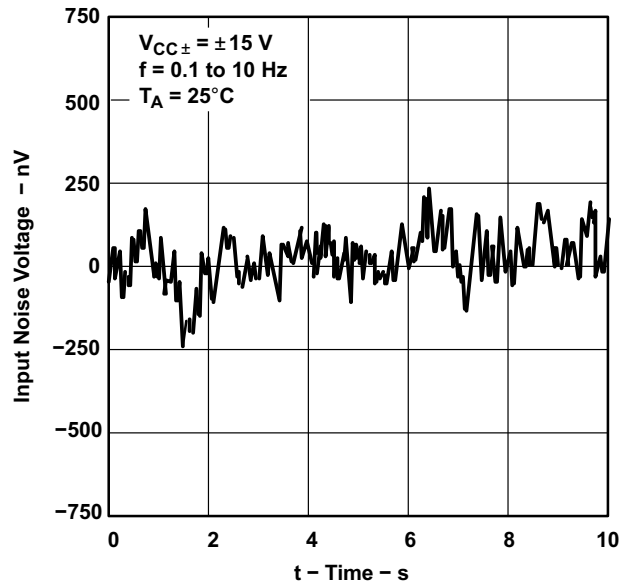
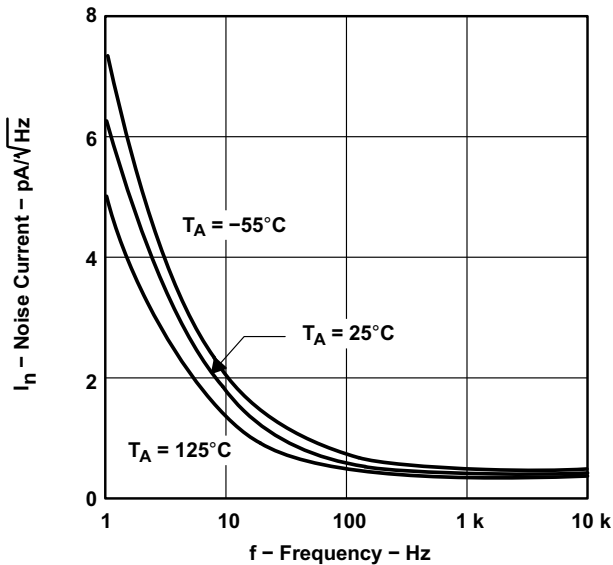

Figure 5-26. Input Noise Voltage Over a 10-Second Period



1. Data at high and low temperatures are applicable only within the rated operating free-air temperature ranges of the various devices.

Figure 5-27. Noise Current⁽¹⁾ vs Frequency

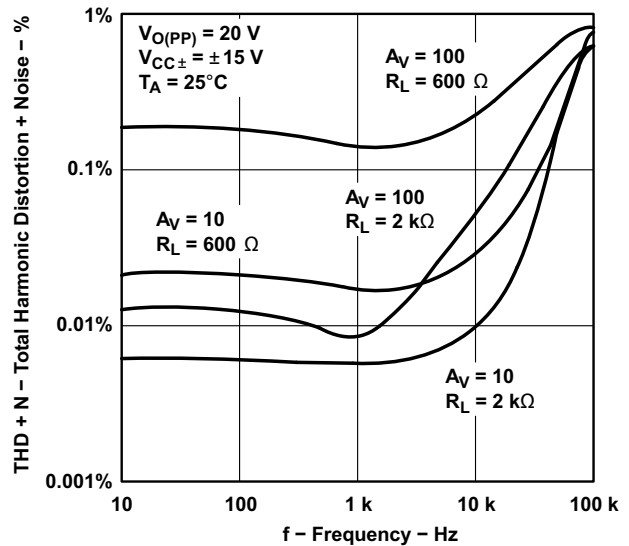
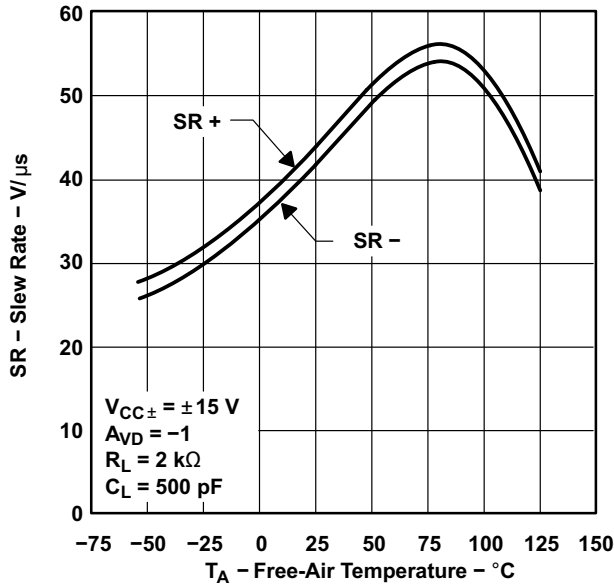

Figure 5-28. Total Harmonic Distortion Plus Noise vs Frequency

5.42 Typical Characteristics (continued)



1. Data at high and low temperatures are applicable only within the rated operating free-air temperature ranges of the various devices.

Figure 5-29. Slew Rate⁽¹⁾ vs Free-Air Temperature

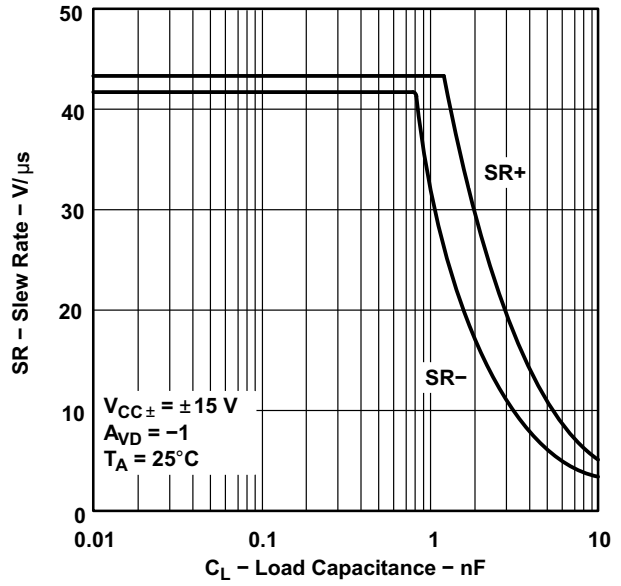
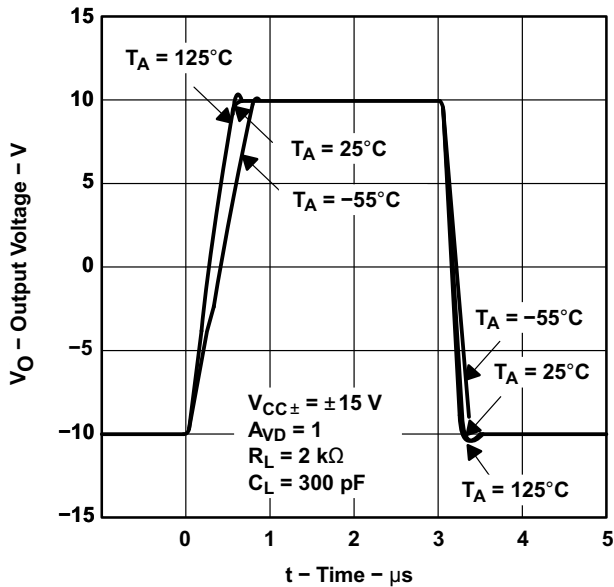
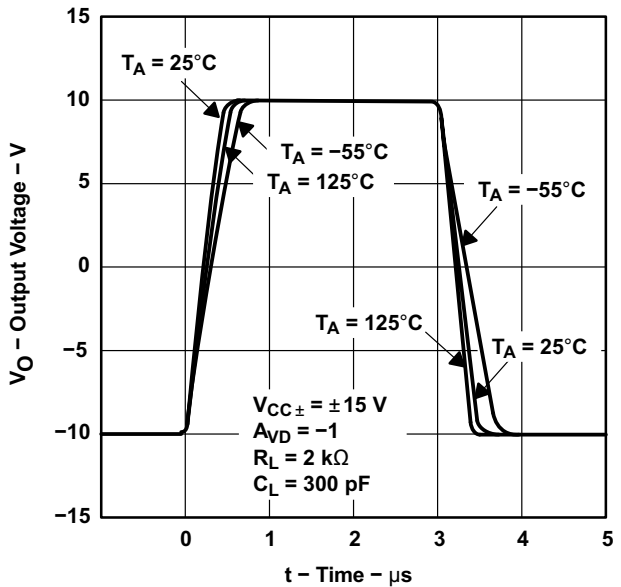

Figure 5-30. Slew Rate vs Load Capacitance



1. Data at high and low temperatures are applicable only within the rated operating free-air temperature ranges of the various devices.

Figure 5-31. Noninverting Large-Signal Pulse Response⁽¹⁾



1. Data at high and low temperatures are applicable only within the rated operating free-air temperature ranges of the various devices.

Figure 5-32. Inverting Large-Signal Pulse Response⁽¹⁾

5.42 Typical Characteristics (continued)

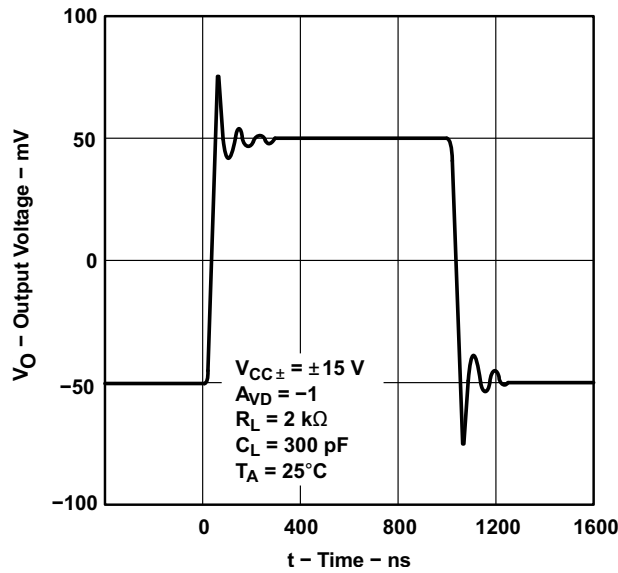
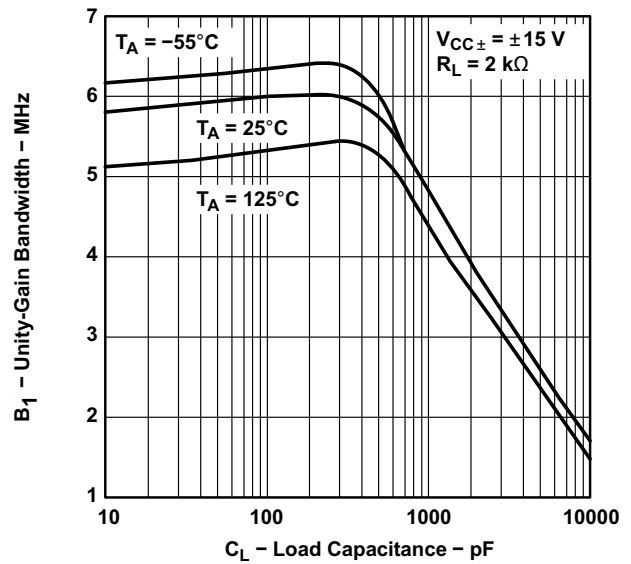

Figure 5-33. Small-Signal Pulse Response



1. Data at high and low temperatures are applicable only within the rated operating free-air temperature ranges of the various devices.

Figure 5-34. Unity-Gain Bandwidth⁽¹⁾ vs Load Capacitance

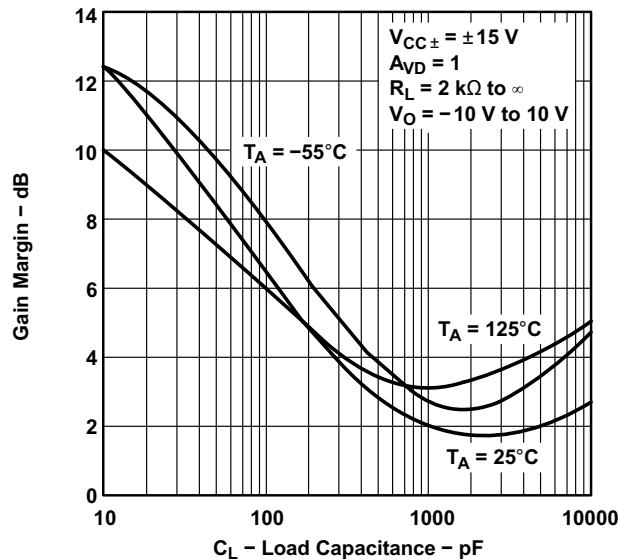
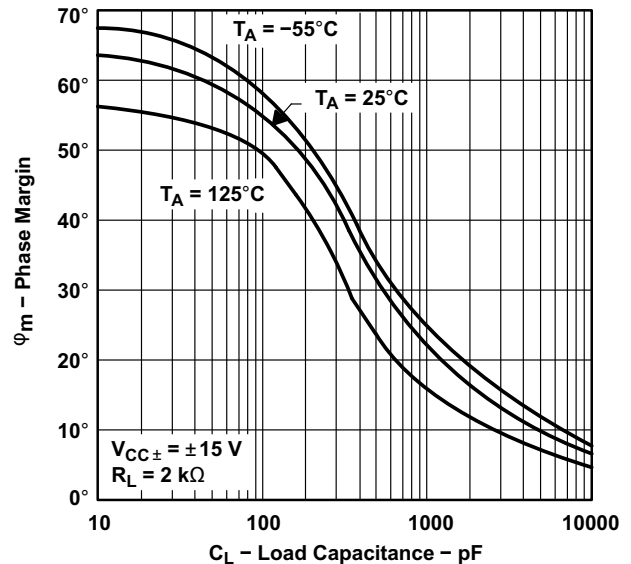

Figure 5-35. Gain Margin vs Load Capacitance



1. Data at high and low temperatures are applicable only within the rated operating free-air temperature ranges of the various devices.

Figure 5-36. Phase Margin⁽¹⁾ vs Load Capacitance

6 Detailed Description

Note

Information in the following applications sections is not part of the TI component specification, and TI does not warrant its accuracy or completeness. TI's customers are responsible for determining suitability of components for their purposes, as well as validating and testing their design implementation to confirm system functionality.

6.1 Overview

The TLE214x amplifiers are stable with capacitive loads up to 10nF, although the 6MHz bandwidth decreases to 1.8MHz at this high loading level. As such, these devices are useful for low-droop sample-and-holds and direct buffering of long cables, including 4mA to 20mA current loops.

The special design also exhibits an improved insensitivity to inherent integrated circuit component mismatches as is evidenced by a 500 μ V maximum offset voltage and 1.7 μ V/ $^{\circ}$ C typical drift. Minimum common-mode rejection ratio and supply-voltage rejection ratio are 85dB and 90dB, respectively.

Device performance is relatively independent of supply voltage over the ± 2 V to ± 22 V range. Inputs can operate between $V_{CC-} - 0.3$ V to $V_{CC+} - 1.8$ V without inducing phase reversal, although excessive input current can flow out of each input exceeding the lower common-mode input range. The all-npn output stage provides a nearly rail-to-rail output swing of $V_{CC-} - 0.1$ V to $V_{CC+} - 1$ V under light current-loading conditions. The device can sustain shorts to either supply since output current is internally limited, but care must be taken to make sure that maximum package power dissipation is not exceeded.

7 Device and Documentation Support

TI offers an extensive line of development tools. Tools and software to evaluate the performance of the device, generate code, and develop solutions are listed below.

7.1 Receiving Notification of Documentation Updates

To receive notification of documentation updates, navigate to the device product folder on ti.com. Click on *Notifications* to register and receive a weekly digest of any product information that has changed. For change details, review the revision history included in any revised document.

7.2 Support Resources

TI E2E™ support forums are an engineer's go-to source for fast, verified answers and design help — straight from the experts. Search existing answers or ask your own question to get the quick design help you need.

Linked content is provided "AS IS" by the respective contributors. They do not constitute TI specifications and do not necessarily reflect TI's views; see TI's [Terms of Use](#).

7.3 Trademarks

TI E2E™ is a trademark of Texas Instruments.
All trademarks are the property of their respective owners.

7.4 Electrostatic Discharge Caution



This integrated circuit can be damaged by ESD. Texas Instruments recommends that all integrated circuits be handled with appropriate precautions. Failure to observe proper handling and installation procedures can cause damage.

ESD damage can range from subtle performance degradation to complete device failure. Precision integrated circuits may be more susceptible to damage because very small parametric changes could cause the device not to meet its published specifications.

7.5 Glossary

[TI Glossary](#) This glossary lists and explains terms, acronyms, and definitions.

8 Revision History

NOTE: Page numbers for previous revisions may differ from page numbers in the current version.

Changes from Revision D (October 2012) to Revision E (July 2025)	Page
• Updated the numbering format for tables, figures, and cross-references throughout the document.....	1
• Changed pins 1 and 5 from OFFSET N1 to NC and OFFSET N2 to NC for TLE2141 D, JG, and P package pinouts.....	3
• Changed typical settling time specification across all devices from 0.34μs (0.1%, ±15V V _S) to 0.43μs, 0.4μs (0.01%, ±15V V _S) to 0.64μs, 0.16μs (0.1%, 5V V _S) to 0.66μs, and 0.22μs (0.01%, 5V V _S) to 0.99μs.....	4
• Changed typical THD+N specification at ±15V V _S across all devices from 0.01% to 0.06%.....	4
• Changed typical maximum output bandwidth specification at 5V V _S across all devices from 660kHz to 380kHz.....	4

9 Mechanical, Packaging, and Orderable Information

The following pages include mechanical, packaging, and orderable information. This information is the most current data available for the designated devices. This data is subject to change without notice and revision of this document. For browser-based versions of this data sheet, refer to the left-hand navigation.

PACKAGING INFORMATION

Orderable part number	Status (1)	Material type (2)	Package Pins	Package qty Carrier	RoHS (3)	Lead finish/ Ball material (4)	MSL rating/ Peak reflow (5)	Op temp (°C)	Part marking (6)
5962-9321603Q2A	Active	Production	LCCC (FK) 20	55 TUBE	No	SNPB	N/A for Pkg Type	-55 to 125	5962- 9321603Q2A TLE2142MFKB
5962-9321603QHA	Active	Production	CFP (U) 10	25 TUBE	No	SNPB	N/A for Pkg Type	-55 to 125	9321603QHA TLE2142M
5962-9321603QPA	Active	Production	CDIP (JG) 8	50 TUBE	No	SNPB	N/A for Pkg Type	-55 to 125	9321603QPA TLE2142M
5962-9321604Q2A	Active	Production	LCCC (FK) 20	55 TUBE	No	SNPB	N/A for Pkg Type	-55 to 125	5962- 9321604Q2A TLE2142 AMFKB
5962-9321604QHA	Active	Production	CFP (U) 10	25 TUBE	No	SNPB	N/A for Pkg Type	-55 to 125	9321604QHA TLE2142AM
5962-9321604QPA	Active	Production	CDIP (JG) 8	50 TUBE	No	SNPB	N/A for Pkg Type	-55 to 125	9321604QPA TLE2142AM
5962-9321605Q2A	Active	Production	LCCC (FK) 20	55 TUBE	No	SNPB	N/A for Pkg Type	-55 to 125	5962- 9321605Q2A TLE2144MFKB
5962-9321605QCA	Active	Production	CDIP (J) 14	25 TUBE	No	SNPB	N/A for Pkg Type	-55 to 125	5962-9321605QC A TLE2144MJB
5962-9321606Q2A	Active	Production	LCCC (FK) 20	55 TUBE	No	SNPB	N/A for Pkg Type	-55 to 125	5962- 9321606Q2A TLE2144 AMFKB
5962-9321606QCA	Active	Production	CDIP (J) 14	25 TUBE	No	SNPB	N/A for Pkg Type	-55 to 125	5962-9321606QC A TLE2144AMJB
TLE2141ACD	Obsolete	Production	SOIC (D) 8	-	-	Call TI	Call TI	-	2141AC
TLE2141ACP	Active	Production	PDIP (P) 8	50 TUBE	Yes	NIPDAU	N/A for Pkg Type	-	TLE2141AC
TLE2141ACP.A	Active	Production	PDIP (P) 8	50 TUBE	Yes	NIPDAU	N/A for Pkg Type	0 to 70	TLE2141AC
TLE2141AID	Obsolete	Production	SOIC (D) 8	-	-	Call TI	Call TI	-	2141AI
TLE2141AIDR	Active	Production	SOIC (D) 8	2500 LARGE T&R	Yes	NIPDAU	Level-1-260C-UNLIM	-	2141AI
TLE2141AIDR.A	Active	Production	SOIC (D) 8	2500 LARGE T&R	Yes	NIPDAU	Level-1-260C-UNLIM	0 to 70	2141AI

Orderable part number	Status (1)	Material type (2)	Package Pins	Package qty Carrier	RoHS (3)	Lead finish/ Ball material (4)	MSL rating/ Peak reflow (5)	Op temp (°C)	Part marking (6)
TLE2141AIP	Active	Production	PDIP (P) 8	50 TUBE	Yes	NIPDAU	N/A for Pkg Type	0 to 70	TLE2141AI
TLE2141AIP.A	Active	Production	PDIP (P) 8	50 TUBE	Yes	NIPDAU	N/A for Pkg Type	0 to 70	TLE2141AI
TLE2141CD	Obsolete	Production	SOIC (D) 8	-	-	Call TI	Call TI	-	2141C
TLE2141CDR	Active	Production	SOIC (D) 8	2500 LARGE T&R	Yes	NIPDAU	Level-1-260C-UNLIM	-	2141C
TLE2141CDR.A	Active	Production	SOIC (D) 8	2500 LARGE T&R	Yes	NIPDAU	Level-1-260C-UNLIM	-55 to 125	2141C
TLE2141CDRG4	Active	Production	SOIC (D) 8	2500 LARGE T&R	-	Call TI	Call TI	See TLE2141CDR	
TLE2141CP	Active	Production	PDIP (P) 8	50 TUBE	Yes	NIPDAU	N/A for Pkg Type	-	TLE2141CP
TLE2141CP.A	Active	Production	PDIP (P) 8	50 TUBE	Yes	NIPDAU	N/A for Pkg Type	-55 to 125	TLE2141CP
TLE2141ID	Obsolete	Production	SOIC (D) 8	-	-	Call TI	Call TI	-	2141I
TLE2141IDR	Active	Production	SOIC (D) 8	2500 LARGE T&R	Yes	NIPDAU	Level-1-260C-UNLIM	-	2141I
TLE2141IDR.A	Active	Production	SOIC (D) 8	2500 LARGE T&R	Yes	NIPDAU	Level-1-260C-UNLIM	-55 to 125	2141I
TLE2141IP	Active	Production	PDIP (P) 8	50 TUBE	Yes	NIPDAU	N/A for Pkg Type	-	TLE2141IP
TLE2141IP.A	Active	Production	PDIP (P) 8	50 TUBE	Yes	NIPDAU	N/A for Pkg Type	-55 to 125	TLE2141IP
TLE2141MD	Active	Production	SOIC (D) 8	75 TUBE	Yes	NIPDAU	Level-1-260C-UNLIM	-55 to 125	2141M
TLE2141MD.A	Active	Production	SOIC (D) 8	75 TUBE	Yes	NIPDAU	Level-1-260C-UNLIM	-55 to 125	2141M
TLE2141MDR	Active	Production	SOIC (D) 8	2500 LARGE T&R	Yes	NIPDAU	Level-1-260C-UNLIM	-55 to 125	2141M
TLE2141MDR.A	Active	Production	SOIC (D) 8	2500 LARGE T&R	Yes	NIPDAU	Level-1-260C-UNLIM	-55 to 125	2141M
TLE2142ACD	Obsolete	Production	SOIC (D) 8	-	-	Call TI	Call TI	0 to 70	2142AC
TLE2142ACDR	Active	Production	SOIC (D) 8	2500 LARGE T&R	Yes	NIPDAU	Level-1-260C-UNLIM	-	2142AC
TLE2142ACDR.A	Active	Production	SOIC (D) 8	2500 LARGE T&R	Yes	NIPDAU	Level-1-260C-UNLIM	-40 to 85	2142AC
TLE2142AID	Obsolete	Production	SOIC (D) 8	-	-	Call TI	Call TI	-40 to 85	2142AI
TLE2142AIDR	Active	Production	SOIC (D) 8	2500 LARGE T&R	Yes	NIPDAU	Level-1-260C-UNLIM	-	2142AI
TLE2142AIDR.A	Active	Production	SOIC (D) 8	2500 LARGE T&R	Yes	NIPDAU	Level-1-260C-UNLIM	-40 to 85	2142AI
TLE2142AMD	Obsolete	Production	SOIC (D) 8	-	-	Call TI	Call TI	-55 to 125	
TLE2142AMDG4	Obsolete	Production	SOIC (D) 8	-	-	Call TI	Call TI	-	E2142A
TLE2142AMDR	Active	Production	SOIC (D) 8	2500 LARGE T&R	Yes	NIPDAU	Level-1-260C-UNLIM	-55 to 125	E2142A
TLE2142AMDR.A	Active	Production	SOIC (D) 8	2500 LARGE T&R	Yes	NIPDAU	Level-1-260C-UNLIM	-55 to 125	E2142A
TLE2142AMDRG4	Obsolete	Production	SOIC (D) 8	-	-	Call TI	Call TI	-	

Orderable part number	Status (1)	Material type (2)	Package Pins	Package qty Carrier	RoHS (3)	Lead finish/ Ball material (4)	MSL rating/ Peak reflow (5)	Op temp (°C)	Part marking (6)
TLE2142AMFKB	Active	Production	LCCC (FK) 20	55 TUBE	No	SNPB	N/A for Pkg Type	-55 to 125	5962- 9321604Q2A TLE2142 AMFKB
TLE2142AMFKB.A	Active	Production	LCCC (FK) 20	55 TUBE	No	SNPB	N/A for Pkg Type	-55 to 125	5962- 9321604Q2A TLE2142 AMFKB
TLE2142AMJG	Active	Production	CDIP (JG) 8	50 TUBE	No	SNPB	N/A for Pkg Type	-	TLE2142AMJG
TLE2142AMJG.A	Active	Production	CDIP (JG) 8	50 TUBE	No	SNPB	N/A for Pkg Type	-55 to 125	TLE2142AMJG
TLE2142AMJGB	Active	Production	CDIP (JG) 8	50 TUBE	No	SNPB	N/A for Pkg Type	-55 to 125	9321604QPA TLE2142AM
TLE2142AMJGB.A	Active	Production	CDIP (JG) 8	50 TUBE	No	SNPB	N/A for Pkg Type	-55 to 125	9321604QPA TLE2142AM
TLE2142AMUB	Active	Production	CFP (U) 10	25 TUBE	No	SNPB	N/A for Pkg Type	-55 to 125	9321604QHA TLE2142AM
TLE2142AMUB.A	Active	Production	CFP (U) 10	25 TUBE	No	SNPB	N/A for Pkg Type	-55 to 125	9321604QHA TLE2142AM
TLE2142CD	Obsolete	Production	SOIC (D) 8	-	-	Call TI	Call TI	0 to 70	2142C
TLE2142CDR	Active	Production	SOIC (D) 8	2500 LARGE T&R	Yes	NIPDAU	Level-1-260C-UNLIM	0 to 70	2142C
TLE2142CDR.A	Active	Production	SOIC (D) 8	2500 LARGE T&R	Yes	NIPDAU	Level-1-260C-UNLIM	0 to 70	2142C
TLE2142CDRG4	Active	Production	SOIC (D) 8	2500 LARGE T&R	-	Call TI	Call TI	0 to 70	
TLE2142CP	Active	Production	PDIP (P) 8	50 TUBE	Yes	NIPDAU	N/A for Pkg Type	0 to 70	TLE2142CP
TLE2142CP.A	Active	Production	PDIP (P) 8	50 TUBE	Yes	NIPDAU	N/A for Pkg Type	0 to 70	TLE2142CP
TLE2142CPWR	Active	Production	TSSOP (PW) 16	2000 LARGE T&R	Yes	NIPDAU	Level-1-260C-UNLIM	0 to 70	Q2142
TLE2142CPWR.A	Active	Production	TSSOP (PW) 16	2000 LARGE T&R	Yes	NIPDAU	Level-1-260C-UNLIM	0 to 70	Q2142
TLE2142ID	Obsolete	Production	SOIC (D) 8	-	-	Call TI	Call TI	-40 to 105	2142I
TLE2142IDR	Active	Production	SOIC (D) 8	2500 LARGE T&R	Yes	NIPDAU	Level-1-260C-UNLIM	-40 to 105	2142I
TLE2142IDR.A	Active	Production	SOIC (D) 8	2500 LARGE T&R	Yes	NIPDAU	Level-1-260C-UNLIM	-40 to 105	2142I
TLE2142IP	Active	Production	PDIP (P) 8	50 TUBE	Yes	NIPDAU	N/A for Pkg Type	-40 to 105	TLE2142IP
TLE2142IP.A	Active	Production	PDIP (P) 8	50 TUBE	Yes	NIPDAU	N/A for Pkg Type	-40 to 105	TLE2142IP
TLE2142MD	Obsolete	Production	SOIC (D) 8	-	-	Call TI	Call TI	-55 to 125	
TLE2142MDG4	Obsolete	Production	SOIC (D) 8	-	-	Call TI	Call TI	-	

Orderable part number	Status (1)	Material type (2)	Package Pins	Package qty Carrier	RoHS (3)	Lead finish/ Ball material (4)	MSL rating/ Peak reflow (5)	Op temp (°C)	Part marking (6)
TLE2142MDR	Active	Production	SOIC (D) 8	2500 LARGE T&R	Yes	NIPDAU	Level-1-260C-UNLIM	-55 to 125	2142M
TLE2142MDR.A	Active	Production	SOIC (D) 8	2500 LARGE T&R	Yes	NIPDAU	Level-1-260C-UNLIM	-55 to 125	2142M
TLE2142MFKB	Active	Production	LCCC (FK) 20	55 TUBE	No	SNPB	N/A for Pkg Type	-55 to 125	5962-9321603Q2A TLE2142MFKB
TLE2142MFKB.A	Active	Production	LCCC (FK) 20	55 TUBE	No	SNPB	N/A for Pkg Type	-55 to 125	5962-9321603Q2A TLE2142MFKB
TLE2142MJGB	Active	Production	CDIP (JG) 8	50 TUBE	No	SNPB	N/A for Pkg Type	-55 to 125	9321603QPA TLE2142M
TLE2142MJGB.A	Active	Production	CDIP (JG) 8	50 TUBE	No	SNPB	N/A for Pkg Type	-55 to 125	9321603QPA TLE2142M
TLE2142MUB	Active	Production	CFP (U) 10	25 TUBE	No	SNPB	N/A for Pkg Type	-55 to 125	9321603QHA TLE2142M
TLE2142MUB.A	Active	Production	CFP (U) 10	25 TUBE	No	SNPB	N/A for Pkg Type	-55 to 125	9321603QHA TLE2142M
TLE2144ACN	Active	Production	PDIP (N) 14	25 TUBE	Yes	NIPDAU	N/A for Pkg Type	0 to 70	TLE2144ACN
TLE2144ACN.A	Active	Production	PDIP (N) 14	25 TUBE	Yes	NIPDAU	N/A for Pkg Type	0 to 70	TLE2144ACN
TLE2144AIN	Active	Production	PDIP (N) 14	25 TUBE	Yes	NIPDAU	N/A for Pkg Type	-40 to 85	TLE2144AIN
TLE2144AIN.A	Active	Production	PDIP (N) 14	25 TUBE	Yes	NIPDAU	N/A for Pkg Type	-40 to 85	TLE2144AIN
TLE2144AMFKB	Active	Production	LCCC (FK) 20	55 TUBE	No	SNPB	N/A for Pkg Type	-55 to 125	5962-9321606Q2A TLE2144 AMFKB
TLE2144AMFKB.A	Active	Production	LCCC (FK) 20	55 TUBE	No	SNPB	N/A for Pkg Type	-55 to 125	5962-9321606Q2A TLE2144 AMFKB
TLE2144AMJB	Active	Production	CDIP (J) 14	25 TUBE	No	SNPB	N/A for Pkg Type	-55 to 125	5962-9321606QC A TLE2144AMJB
TLE2144AMJB.A	Active	Production	CDIP (J) 14	25 TUBE	No	SNPB	N/A for Pkg Type	-55 to 125	5962-9321606QC A TLE2144AMJB
TLE2144CDW	Active	Production	SOIC (DW) 16	40 TUBE	Yes	NIPDAU	Level-1-260C-UNLIM	0 to 70	TLE2144C

Orderable part number	Status (1)	Material type (2)	Package Pins	Package qty Carrier	RoHS (3)	Lead finish/ Ball material (4)	MSL rating/ Peak reflow (5)	Op temp (°C)	Part marking (6)
TLE2144CDW.A	Active	Production	SOIC (DW) 16	40 TUBE	Yes	NIPDAU	Level-1-260C-UNLIM	0 to 70	TLE2144C
TLE2144CDWR	Active	Production	SOIC (DW) 16	2000 LARGE T&R	Yes	NIPDAU	Level-1-260C-UNLIM	0 to 70	TLE2144C
TLE2144CDWR.A	Active	Production	SOIC (DW) 16	2000 LARGE T&R	Yes	NIPDAU	Level-1-260C-UNLIM	0 to 70	TLE2144C
TLE2144CN	Active	Production	PDIP (N) 14	25 TUBE	Yes	NIPDAU	N/A for Pkg Type	0 to 70	TLE2144CN
TLE2144CN.A	Active	Production	PDIP (N) 14	25 TUBE	Yes	NIPDAU	N/A for Pkg Type	0 to 70	TLE2144CN
TLE2144IDW	Active	Production	SOIC (DW) 16	40 TUBE	Yes	NIPDAU	Level-1-260C-UNLIM	-40 to 105	TLE2144I
TLE2144IDW.A	Active	Production	SOIC (DW) 16	40 TUBE	Yes	NIPDAU	Level-1-260C-UNLIM	-40 to 105	TLE2144I
TLE2144IDWR	Active	Production	SOIC (DW) 16	2000 LARGE T&R	Yes	NIPDAU	Level-1-260C-UNLIM	-40 to 105	TLE2144I
TLE2144IDWR.A	Active	Production	SOIC (DW) 16	2000 LARGE T&R	Yes	NIPDAU	Level-1-260C-UNLIM	-40 to 105	TLE2144I
TLE2144IN	Active	Production	PDIP (N) 14	25 TUBE	Yes	NIPDAU	N/A for Pkg Type	-40 to 105	TLE2144IN
TLE2144IN.A	Active	Production	PDIP (N) 14	25 TUBE	Yes	NIPDAU	N/A for Pkg Type	-40 to 105	TLE2144IN
TLE2144MDW	Active	Production	SOIC (DW) 16	40 TUBE	Yes	NIPDAU	Level-1-260C-UNLIM	-55 to 125	TLE2144M
TLE2144MDW.A	Active	Production	SOIC (DW) 16	40 TUBE	Yes	NIPDAU	Level-1-260C-UNLIM	-55 to 125	TLE2144M
TLE2144MDWG4	Active	Production	SOIC (DW) 16	40 TUBE	Yes	NIPDAU	Level-1-260C-UNLIM	-	TLE2144M
TLE2144MDWG4.A	Active	Production	SOIC (DW) 16	40 TUBE	Yes	NIPDAU	Level-1-260C-UNLIM	-55 to 125	TLE2144M
TLE2144MFKB	Active	Production	LCCC (FK) 20	55 TUBE	No	SNPB	N/A for Pkg Type	-55 to 125	5962- 9321605Q2A TLE2144MFKB
TLE2144MFKB.A	Active	Production	LCCC (FK) 20	55 TUBE	No	SNPB	N/A for Pkg Type	-55 to 125	5962- 9321605Q2A TLE2144MFKB
TLE2144MJB	Active	Production	CDIP (J) 14	25 TUBE	No	SNPB	N/A for Pkg Type	-55 to 125	5962-9321605QC A TLE2144MJB
TLE2144MJB.A	Active	Production	CDIP (J) 14	25 TUBE	No	SNPB	N/A for Pkg Type	-55 to 125	5962-9321605QC A TLE2144MJB

(1) **Status:** For more details on status, see our [product life cycle](#).

(2) **Material type:** When designated, preproduction parts are prototypes/experimental devices, and are not yet approved or released for full production. Testing and final process, including without limitation quality assurance, reliability performance testing, and/or process qualification, may not yet be complete, and this item is subject to further changes or possible discontinuation. If available for ordering, purchases will be subject to an additional waiver at checkout, and are intended for early internal evaluation purposes only. These items are sold without warranties of any kind.

(3) **RoHS values:** Yes, No, RoHS Exempt. See the [TI RoHS Statement](#) for additional information and value definition.

(4) **Lead finish/Ball material:** Parts may have multiple material finish options. Finish options are separated by a vertical ruled line. Lead finish/Ball material values may wrap to two lines if the finish value exceeds the maximum column width.

(5) **MSL rating/Peak reflow:** The moisture sensitivity level ratings and peak solder (reflow) temperatures. In the event that a part has multiple moisture sensitivity ratings, only the lowest level per JEDEC standards is shown. Refer to the shipping label for the actual reflow temperature that will be used to mount the part to the printed circuit board.

(6) **Part marking:** There may be an additional marking, which relates to the logo, the lot trace code information, or the environmental category of the part.

Multiple part markings will be inside parentheses. Only one part marking contained in parentheses and separated by a "~" will appear on a part. If a line is indented then it is a continuation of the previous line and the two combined represent the entire part marking for that device.

Important Information and Disclaimer: The information provided on this page represents TI's knowledge and belief as of the date that it is provided. TI bases its knowledge and belief on information provided by third parties, and makes no representation or warranty as to the accuracy of such information. Efforts are underway to better integrate information from third parties. TI has taken and continues to take reasonable steps to provide representative and accurate information but may not have conducted destructive testing or chemical analysis on incoming materials and chemicals. TI and TI suppliers consider certain information to be proprietary, and thus CAS numbers and other limited information may not be available for release.

In no event shall TI's liability arising out of such information exceed the total purchase price of the TI part(s) at issue in this document sold by TI to Customer on an annual basis.

OTHER QUALIFIED VERSIONS OF TLE2141, TLE2141A, TLE2142, TLE2142A, TLE2142AM, TLE2142M, TLE2144, TLE2144A, TLE2144AM, TLE2144M :

- Catalog : [TLE2142A](#), [TLE2142](#), [TLE2144A](#), [TLE2144](#)
- Automotive : [TLE2141-Q1](#), [TLE2142-Q1](#), [TLE2142-Q1](#)
- Enhanced Product : [TLE2141-EP](#), [TLE2144-EP](#), [TLE2144-EP](#)
- Military : [TLE2141M](#), [TLE2141AM](#), [TLE2142M](#), [TLE2142AM](#), [TLE2144M](#), [TLE2144AM](#)

NOTE: Qualified Version Definitions:

- Catalog - TI's standard catalog product
- Automotive - Q100 devices qualified for high-reliability automotive applications targeting zero defects
- Enhanced Product - Supports Defense, Aerospace and Medical Applications

- Military - QML certified for Military and Defense Applications

TAPE AND REEL INFORMATION

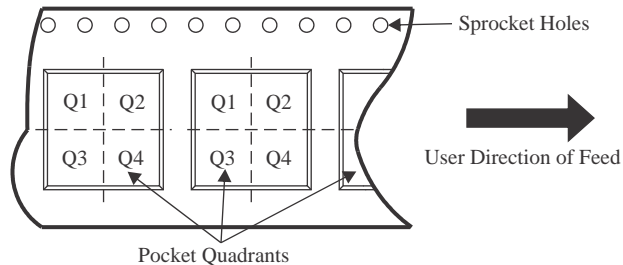
QUADRANT ASSIGNMENTS FOR PIN 1 ORIENTATION IN TAPE

*All dimensions are nominal

Device	Package Type	Package Drawing	Pins	SPQ	Reel Diameter (mm)	Reel Width W1 (mm)	A0 (mm)	B0 (mm)	K0 (mm)	P1 (mm)	W (mm)	Pin1 Quadrant
TLE2141AIDR	SOIC	D	8	2500	330.0	12.4	6.4	5.2	2.1	8.0	12.0	Q1
TLE2141CDR	SOIC	D	8	2500	330.0	12.4	6.4	5.2	2.1	8.0	12.0	Q1
TLE2141IDR	SOIC	D	8	2500	330.0	12.4	6.4	5.2	2.1	8.0	12.0	Q1
TLE2141MDR	SOIC	D	8	2500	330.0	12.4	6.4	5.2	2.1	8.0	12.0	Q1
TLE2142ACDR	SOIC	D	8	2500	330.0	12.4	6.4	5.2	2.1	8.0	12.0	Q1
TLE2142AIDR	SOIC	D	8	2500	330.0	12.4	6.4	5.2	2.1	8.0	12.0	Q1
TLE2142AMDR	SOIC	D	8	2500	330.0	12.4	6.4	5.2	2.1	8.0	12.0	Q1
TLE2142CDR	SOIC	D	8	2500	330.0	12.4	6.4	5.2	2.1	8.0	12.0	Q1
TLE2142CPWR	TSSOP	PW	16	2000	330.0	12.4	6.9	5.6	1.6	8.0	12.0	Q1
TLE2142IDR	SOIC	D	8	2500	330.0	12.4	6.4	5.2	2.1	8.0	12.0	Q1
TLE2142MDR	SOIC	D	8	2500	330.0	12.4	6.4	5.2	2.1	8.0	12.0	Q1
TLE2144CDWR	SOIC	DW	16	2000	330.0	16.4	10.75	10.7	2.7	12.0	16.0	Q1
TLE2144IDWR	SOIC	DW	16	2000	330.0	16.4	10.75	10.7	2.7	12.0	16.0	Q1

TAPE AND REEL BOX DIMENSIONS

*All dimensions are nominal

Device	Package Type	Package Drawing	Pins	SPQ	Length (mm)	Width (mm)	Height (mm)
TLE2141AIDR	SOIC	D	8	2500	353.0	353.0	32.0
TLE2141CDR	SOIC	D	8	2500	353.0	353.0	32.0
TLE2141IDR	SOIC	D	8	2500	353.0	353.0	32.0
TLE2141MDR	SOIC	D	8	2500	350.0	350.0	43.0
TLE2142ACDR	SOIC	D	8	2500	353.0	353.0	32.0
TLE2142AIDR	SOIC	D	8	2500	353.0	353.0	32.0
TLE2142AMDR	SOIC	D	8	2500	353.0	353.0	32.0
TLE2142CDR	SOIC	D	8	2500	353.0	353.0	32.0
TLE2142CPWR	TSSOP	PW	16	2000	353.0	353.0	32.0
TLE2142IDR	SOIC	D	8	2500	353.0	353.0	32.0
TLE2142MDR	SOIC	D	8	2500	353.0	353.0	32.0
TLE2144CDWR	SOIC	DW	16	2000	350.0	350.0	43.0
TLE2144IDWR	SOIC	DW	16	2000	350.0	350.0	43.0

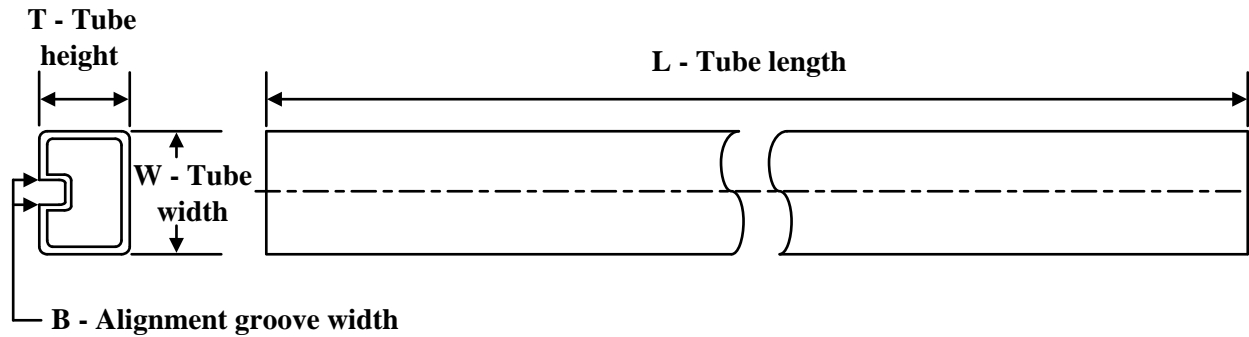
TUBE

*All dimensions are nominal

Device	Package Name	Package Type	Pins	SPQ	L (mm)	W (mm)	T (µm)	B (mm)
5962-9321603Q2A	FK	LCCC	20	55	506.98	12.06	2030	NA
5962-9321603QHA	U	CFP	10	25	506.98	26.16	6220	NA
5962-9321604Q2A	FK	LCCC	20	55	506.98	12.06	2030	NA
5962-9321604QHA	U	CFP	10	25	506.98	26.16	6220	NA
5962-9321605Q2A	FK	LCCC	20	55	506.98	12.06	2030	NA
5962-9321606Q2A	FK	LCCC	20	55	506.98	12.06	2030	NA
TLE2141ACP	P	PDIP	8	50	506	13.97	11230	4.32
TLE2141ACP.A	P	PDIP	8	50	506	13.97	11230	4.32
TLE2141AIP	P	PDIP	8	50	506	13.97	11230	4.32
TLE2141AIP.A	P	PDIP	8	50	506	13.97	11230	4.32
TLE2141CP	P	PDIP	8	50	506	13.97	11230	4.32
TLE2141CP.A	P	PDIP	8	50	506	13.97	11230	4.32
TLE2141IP	P	PDIP	8	50	506	13.97	11230	4.32
TLE2141IP.A	P	PDIP	8	50	506	13.97	11230	4.32
TLE2141MD	D	SOIC	8	75	505.46	6.76	3810	4
TLE2141MD.A	D	SOIC	8	75	505.46	6.76	3810	4
TLE2142AMFKB	FK	LCCC	20	55	506.98	12.06	2030	NA
TLE2142AMFKB.A	FK	LCCC	20	55	506.98	12.06	2030	NA
TLE2142AMUB	U	CFP	10	25	506.98	26.16	6220	NA
TLE2142AMUB.A	U	CFP	10	25	506.98	26.16	6220	NA
TLE2142CP	P	PDIP	8	50	506	13.97	11230	4.32
TLE2142CP.A	P	PDIP	8	50	506	13.97	11230	4.32
TLE2142IP	P	PDIP	8	50	506	13.97	11230	4.32
TLE2142IP.A	P	PDIP	8	50	506	13.97	11230	4.32
TLE2142MFKB	FK	LCCC	20	55	506.98	12.06	2030	NA
TLE2142MFKB.A	FK	LCCC	20	55	506.98	12.06	2030	NA
TLE2142MUB	U	CFP	10	25	506.98	26.16	6220	NA
TLE2142MUB.A	U	CFP	10	25	506.98	26.16	6220	NA
TLE2144ACN	N	PDIP	14	25	506	13.97	11230	4.32

Device	Package Name	Package Type	Pins	SPQ	L (mm)	W (mm)	T (µm)	B (mm)
TLE2144ACN.A	N	PDIP	14	25	506	13.97	11230	4.32
TLE2144AIN	N	PDIP	14	25	506	13.97	11230	4.32
TLE2144AIN.A	N	PDIP	14	25	506	13.97	11230	4.32
TLE2144AMFKB	FK	LCCC	20	55	506.98	12.06	2030	NA
TLE2144AMFKB.A	FK	LCCC	20	55	506.98	12.06	2030	NA
TLE2144CDW	DW	SOIC	16	40	506.98	12.7	4826	6.6
TLE2144CDW.A	DW	SOIC	16	40	506.98	12.7	4826	6.6
TLE2144CN	N	PDIP	14	25	506	13.97	11230	4.32
TLE2144CN.A	N	PDIP	14	25	506	13.97	11230	4.32
TLE2144IDW	DW	SOIC	16	40	506.98	12.7	4826	6.6
TLE2144IDW.A	DW	SOIC	16	40	506.98	12.7	4826	6.6
TLE2144IN	N	PDIP	14	25	506	13.97	11230	4.32
TLE2144IN.A	N	PDIP	14	25	506	13.97	11230	4.32
TLE2144MDW	DW	SOIC	16	40	506.98	12.7	4826	6.6
TLE2144MDW.A	DW	SOIC	16	40	506.98	12.7	4826	6.6
TLE2144MDWG4	DW	SOIC	16	40	506.98	12.7	4826	6.6
TLE2144MDWG4.A	DW	SOIC	16	40	506.98	12.7	4826	6.6
TLE2144MFKB	FK	LCCC	20	55	506.98	12.06	2030	NA
TLE2144MFKB.A	FK	LCCC	20	55	506.98	12.06	2030	NA

GENERIC PACKAGE VIEW

DW 16

SOIC - 2.65 mm max height

7.5 x 10.3, 1.27 mm pitch

SMALL OUTLINE INTEGRATED CIRCUIT

This image is a representation of the package family, actual package may vary.
Refer to the product data sheet for package details.

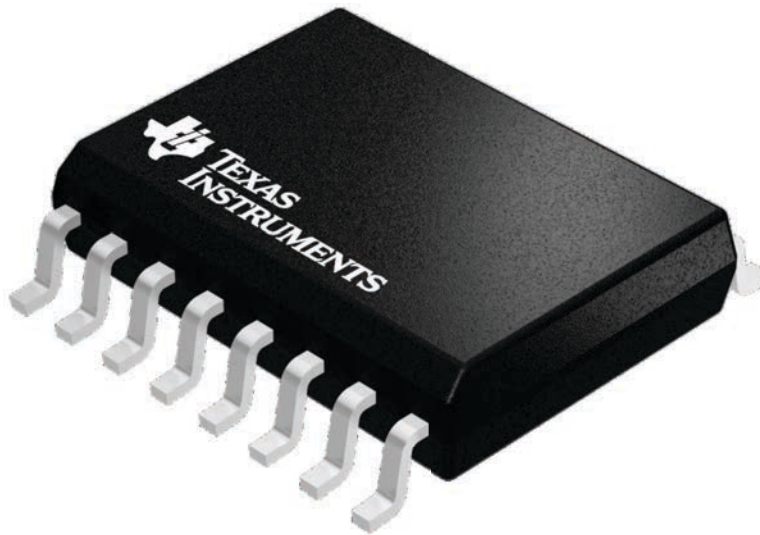

4224780/A

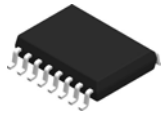

DW0016A

PACKAGE OUTLINE SOIC - 2.65 mm max height

SOIC

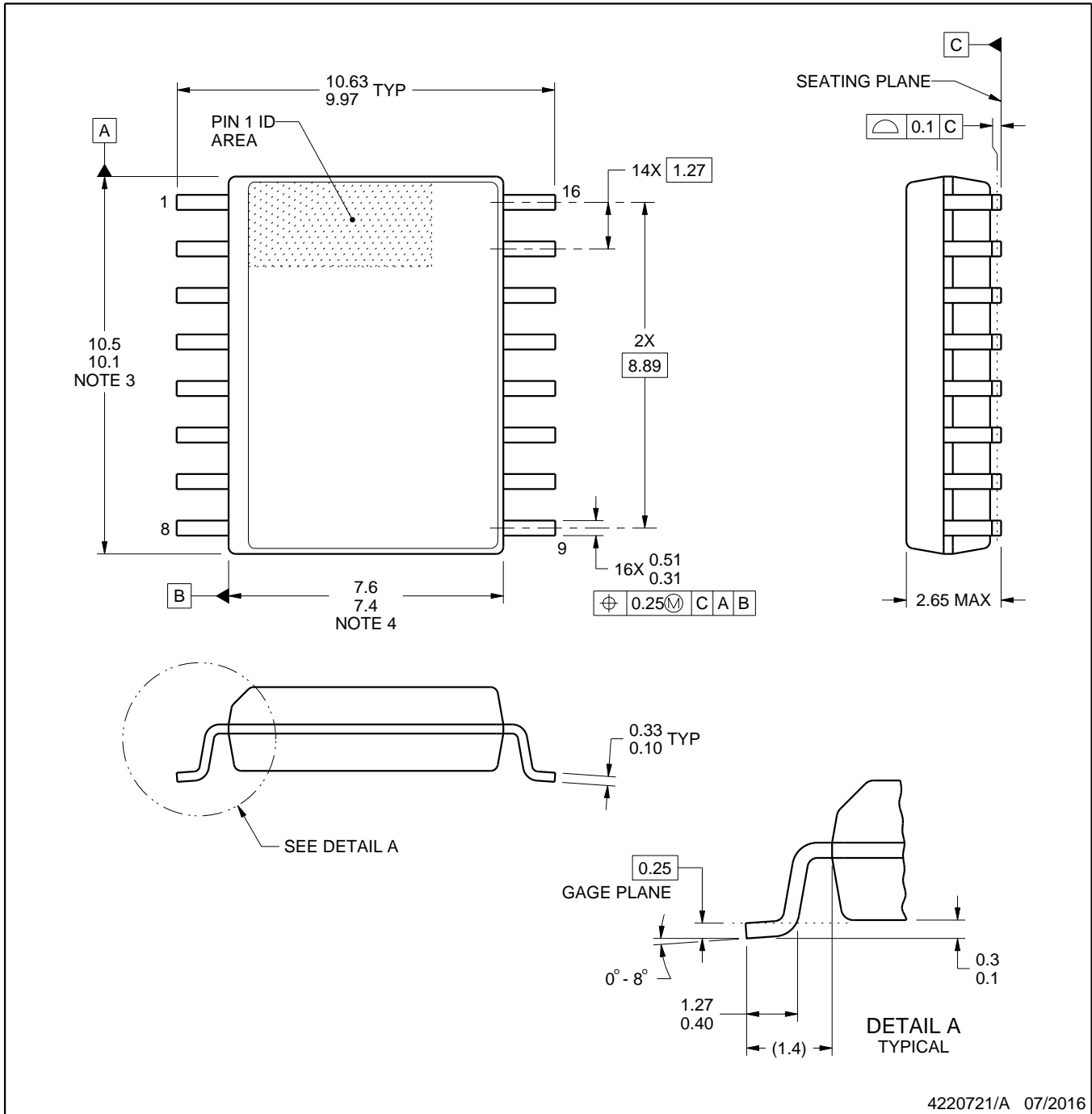

4220721/A 07/2016

NOTES:

1. All linear dimensions are in millimeters. Dimensions in parenthesis are for reference only. Dimensioning and tolerancing per ASME Y14.5M.
2. This drawing is subject to change without notice.
3. This dimension does not include mold flash, protrusions, or gate burrs. Mold flash, protrusions, or gate burrs shall not exceed 0.15 mm, per side.
4. This dimension does not include interlead flash. Interlead flash shall not exceed 0.25 mm, per side.
5. Reference JEDEC registration MS-013.

EXAMPLE BOARD LAYOUT

DW0016A

SOIC - 2.65 mm max height

SOIC

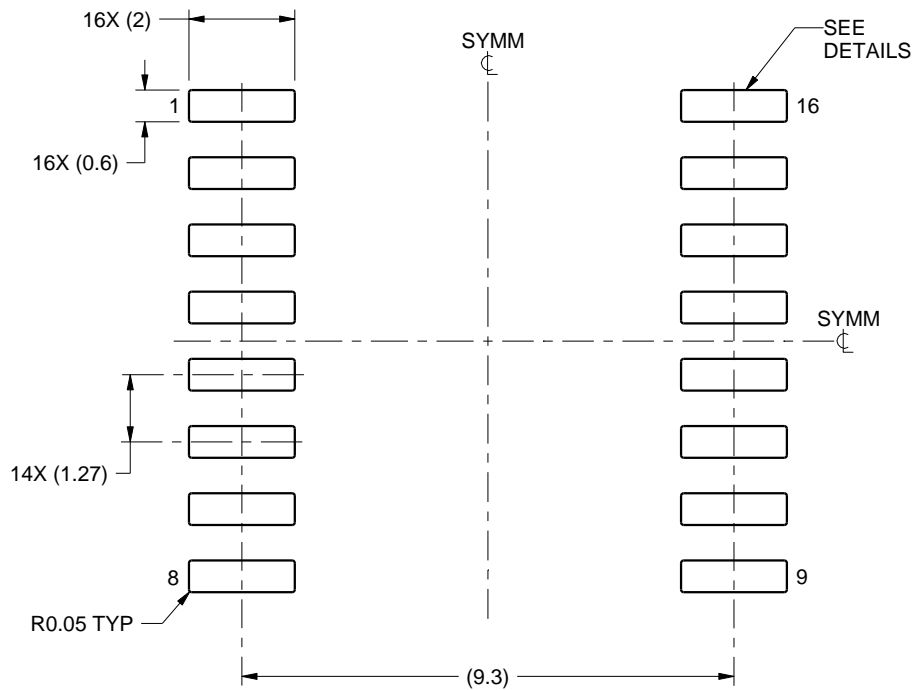

LAND PATTERN EXAMPLE
SCALE:7X

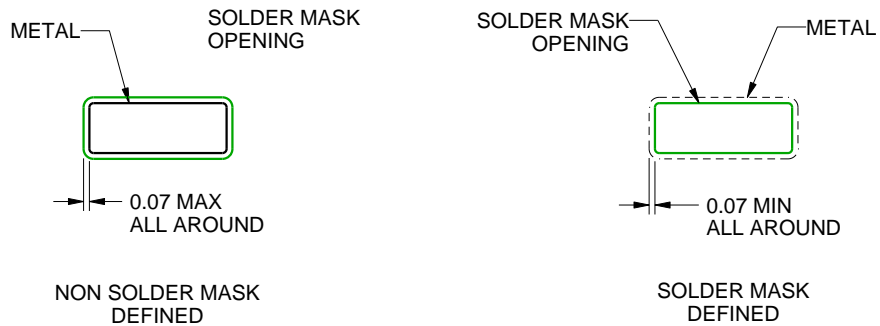

SOLDER MASK DETAILS

4220721/A 07/2016

NOTES: (continued)

6. Publication IPC-7351 may have alternate designs.

7. Solder mask tolerances between and around signal pads can vary based on board fabrication site.

EXAMPLE STENCIL DESIGN

DW0016A

SOIC - 2.65 mm max height

SOIC

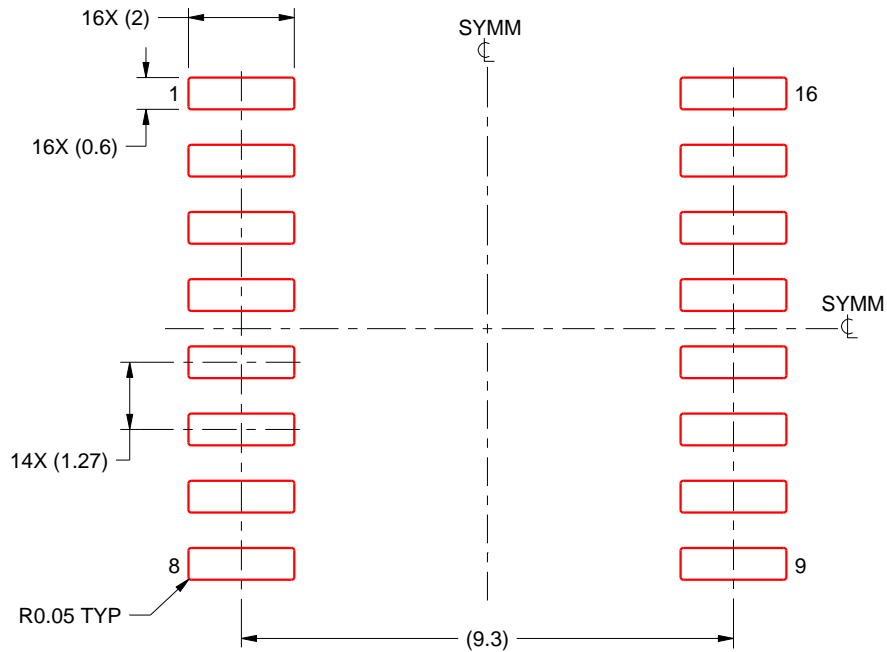

SOLDER PASTE EXAMPLE
BASED ON 0.125 mm THICK STENCIL
SCALE:7X

4220721/A 07/2016

NOTES: (continued)

8. Laser cutting apertures with trapezoidal walls and rounded corners may offer better paste release. IPC-7525 may have alternate design recommendations.
9. Board assembly site may have different recommendations for stencil design.

GENERIC PACKAGE VIEW

FK 20

LCCC - 2.03 mm max height

8.89 x 8.89, 1.27 mm pitch

LEADLESS CERAMIC CHIP CARRIER

This image is a representation of the package family, actual package may vary.
Refer to the product data sheet for package details.

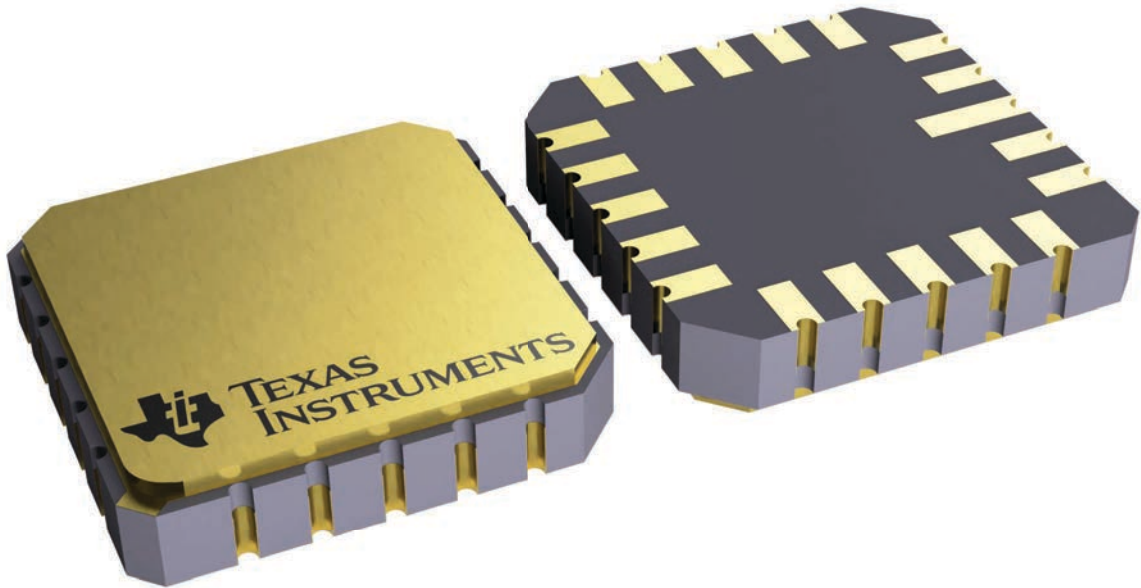

4229370VA\

J 14

GENERIC PACKAGE VIEW
CDIP - 5.08 mm max height
CERAMIC DUAL IN LINE PACKAGE

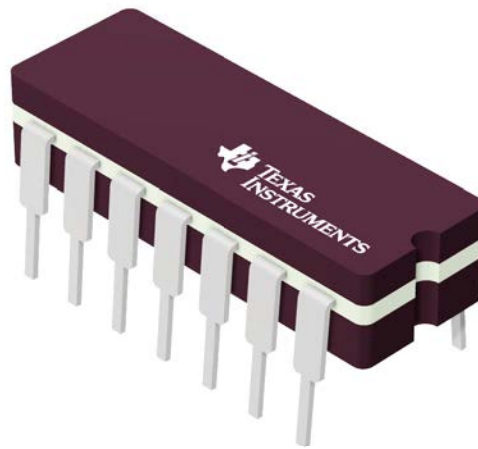

Images above are just a representation of the package family, actual package may vary.
Refer to the product data sheet for package details.

4040083-5/G

J0014A



PACKAGE OUTLINE

CDIP - 5.08 mm max height

CERAMIC DUAL IN LINE PACKAGE

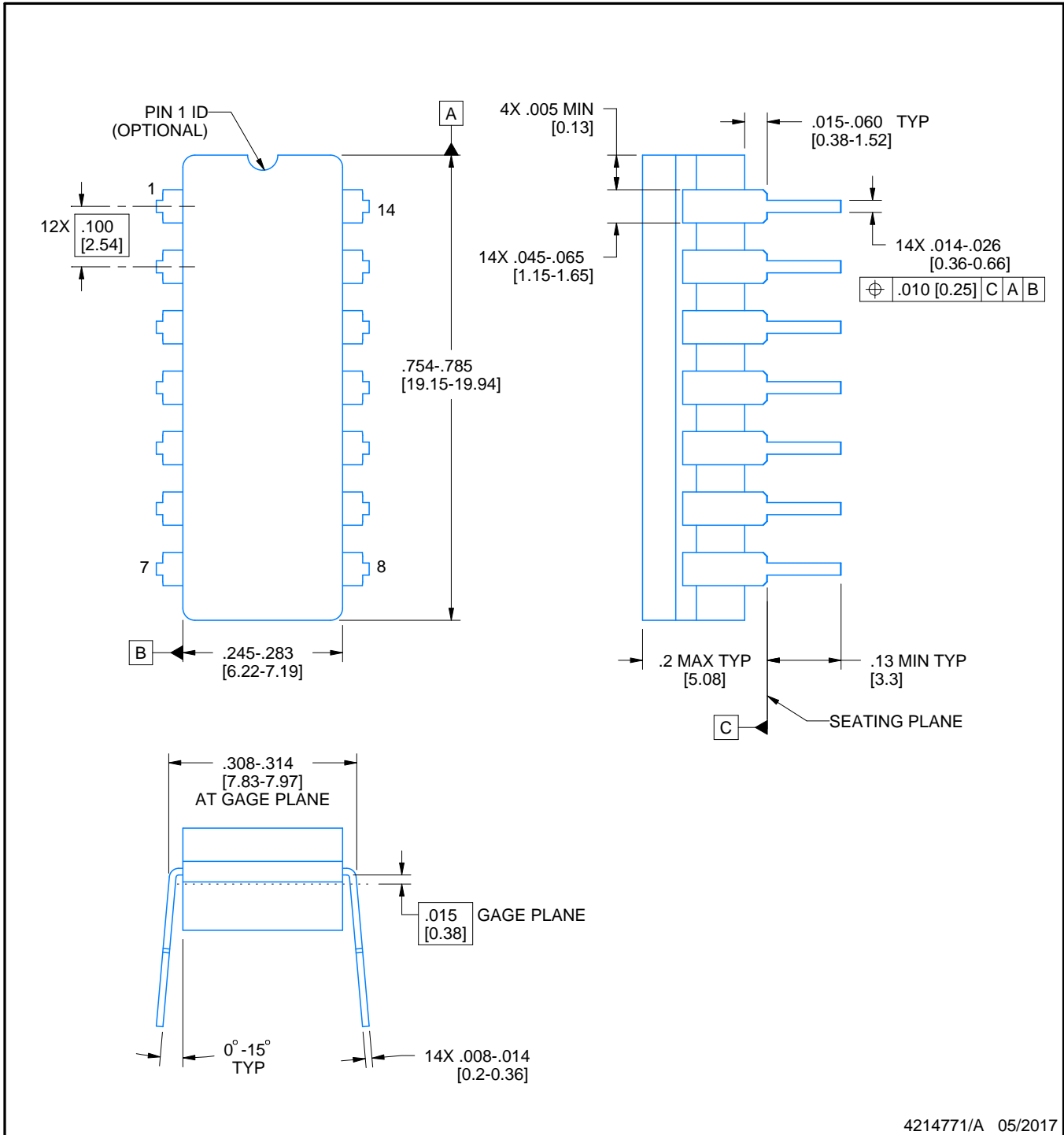

4214771/A 05/2017

NOTES:

1. All controlling linear dimensions are in inches. Dimensions in brackets are in millimeters. Any dimension in brackets or parenthesis are for reference only. Dimensioning and tolerancing per ASME Y14.5M.
2. This drawing is subject to change without notice.
3. This package is hermetically sealed with a ceramic lid using glass frit.
4. Index point is provided on cap for terminal identification only and on press ceramic glass frit seal only.
5. Falls within MIL-STD-1835 and GDIP1-T14.

EXAMPLE BOARD LAYOUT

J0014A

CDIP - 5.08 mm max height

CERAMIC DUAL IN LINE PACKAGE

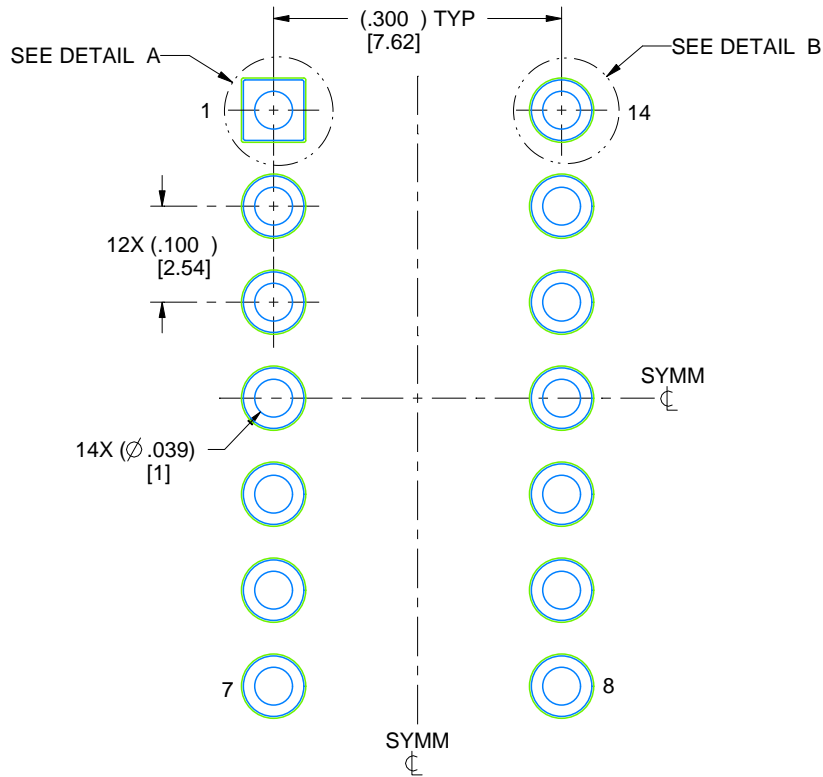

LAND PATTERN EXAMPLE
NON-SOLDER MASK DEFINED
SCALE: 5X

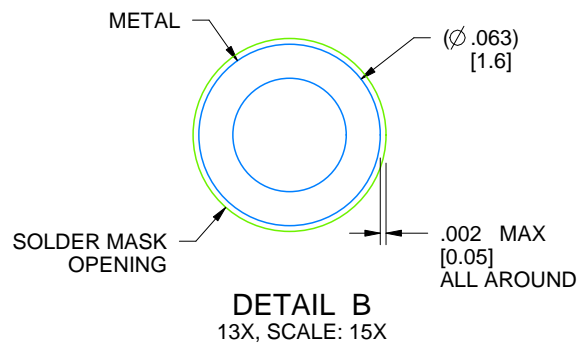

4214771/A 05/2017

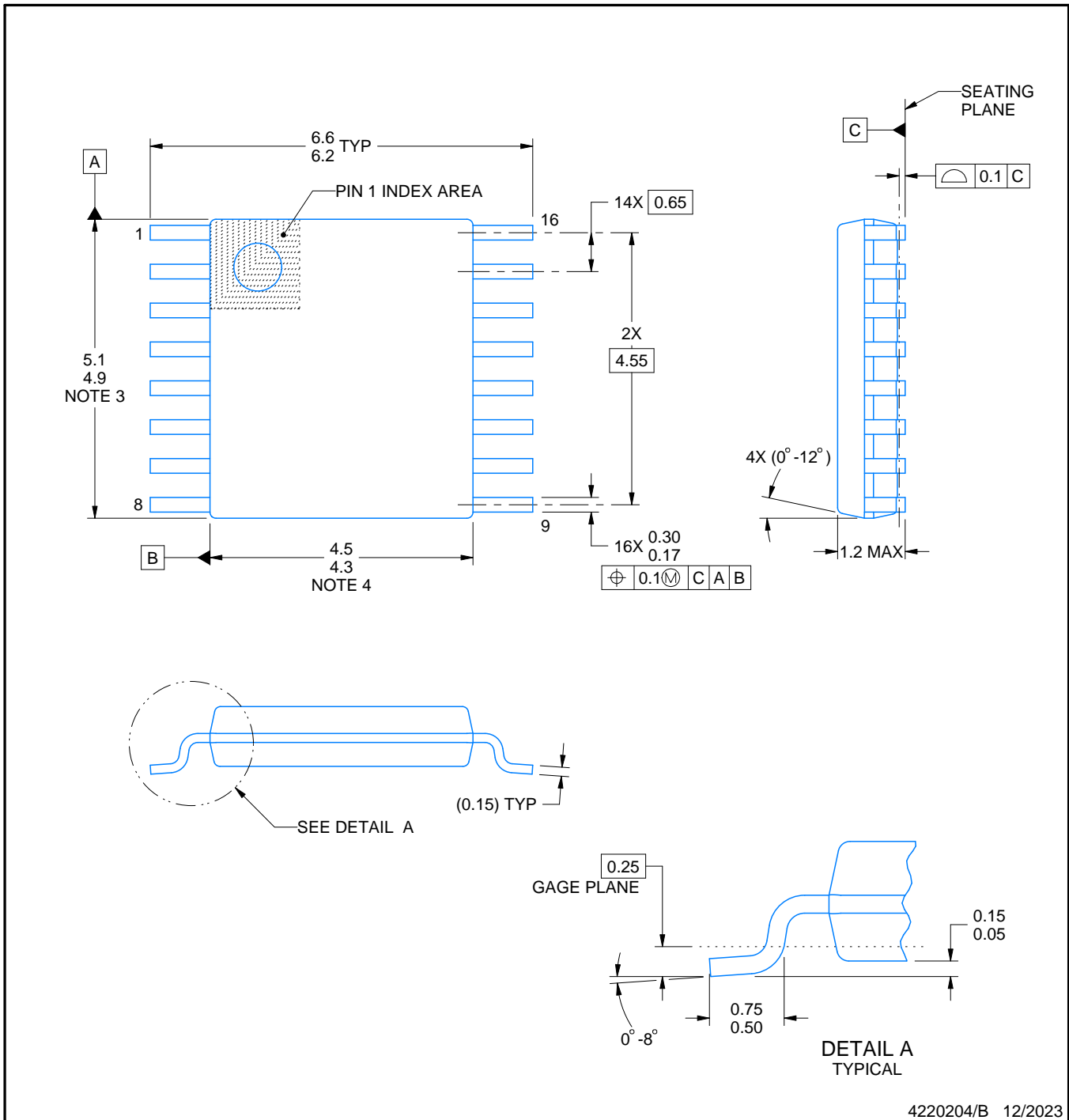
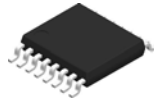

4220204/B 12/2023

NOTES:

1. All linear dimensions are in millimeters. Any dimensions in parenthesis are for reference only. Dimensioning and tolerancing per ASME Y14.5M.
2. This drawing is subject to change without notice.
3. This dimension does not include mold flash, protrusions, or gate burrs. Mold flash, protrusions, or gate burrs shall not exceed 0.15 mm per side.
4. This dimension does not include interlead flash. Interlead flash shall not exceed 0.25 mm per side.
5. Reference JEDEC registration MO-153.

EXAMPLE BOARD LAYOUT

PW0016A

TSSOP - 1.2 mm max height

SMALL OUTLINE PACKAGE

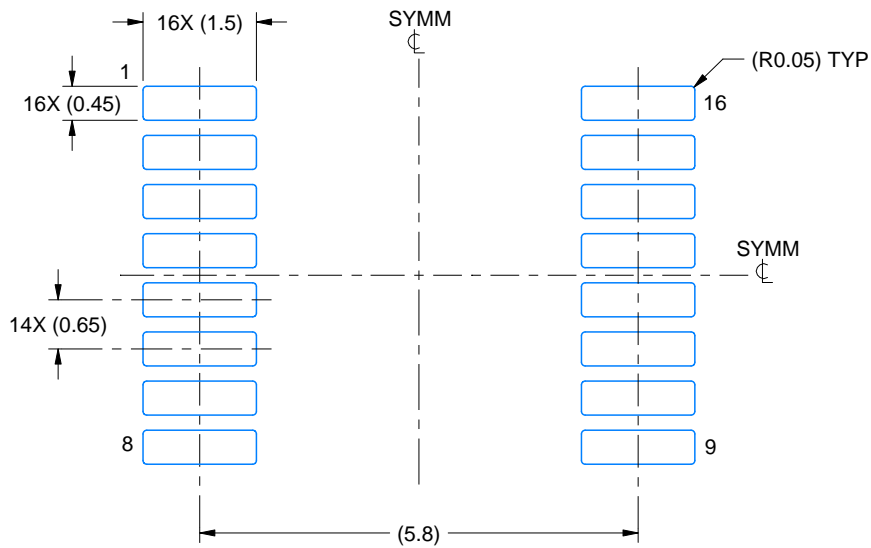

LAND PATTERN EXAMPLE
EXPOSED METAL SHOWN
SCALE: 10X

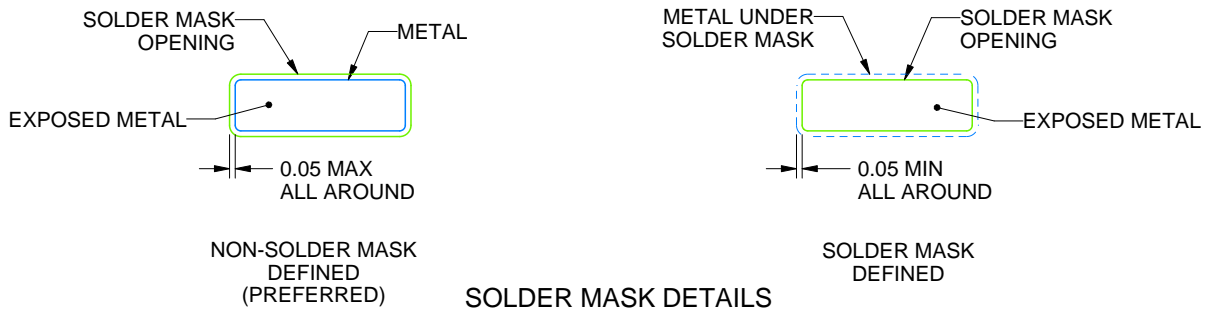

SOLDER MASK DETAILS

4220204/B 12/2023

NOTES: (continued)

6. Publication IPC-7351 may have alternate designs.
7. Solder mask tolerances between and around signal pads can vary based on board fabrication site.

EXAMPLE STENCIL DESIGN

PW0016A

TSSOP - 1.2 mm max height

SMALL OUTLINE PACKAGE

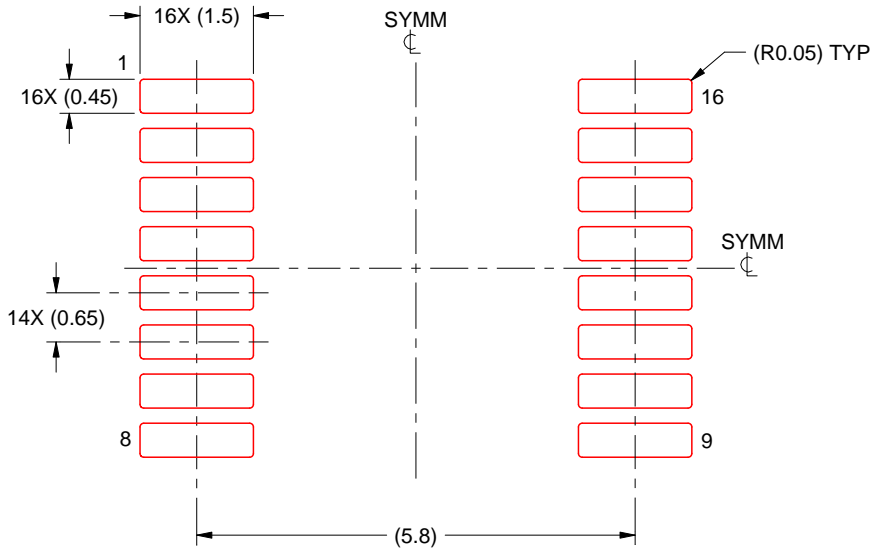

SOLDER PASTE EXAMPLE
BASED ON 0.125 mm THICK STENCIL
SCALE: 10X

4220204/B 12/2023

NOTES: (continued)

8. Laser cutting apertures with trapezoidal walls and rounded corners may offer better paste release. IPC-7525 may have alternate design recommendations.
9. Board assembly site may have different recommendations for stencil design.



D0008A

PACKAGE OUTLINE

SOIC - 1.75 mm max height

SMALL OUTLINE INTEGRATED CIRCUIT

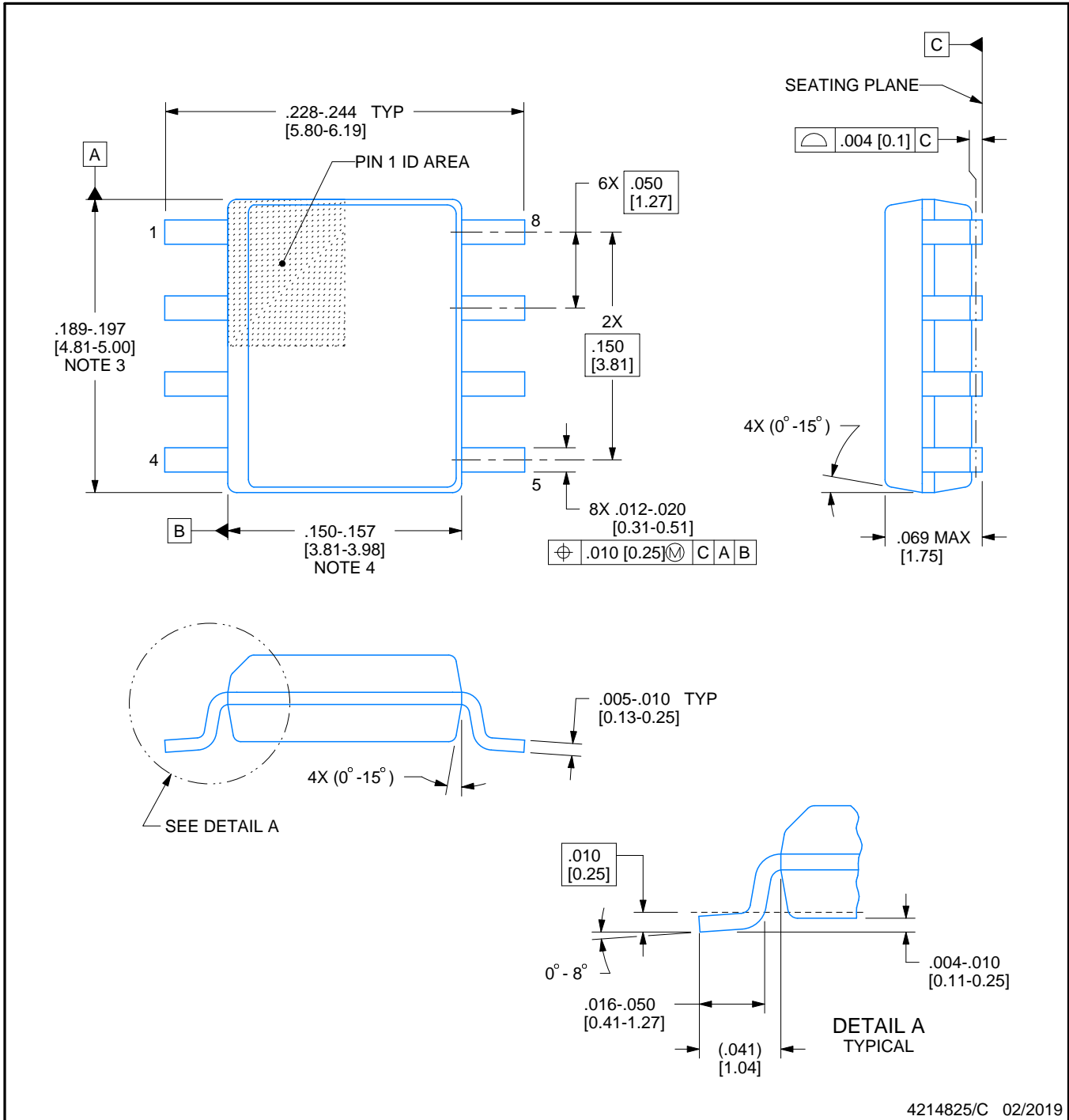

4214825/C 02/2019

NOTES:

- Linear dimensions are in inches [millimeters]. Dimensions in parenthesis are for reference only. Controlling dimensions are in inches. Dimensioning and tolerancing per ASME Y14.5M.
- This drawing is subject to change without notice.
- This dimension does not include mold flash, protrusions, or gate burrs. Mold flash, protrusions, or gate burrs shall not exceed $.006$ [0.15] per side.
- This dimension does not include interlead flash.
- Reference JEDEC registration MS-012, variation AA.

EXAMPLE BOARD LAYOUT

D0008A

SOIC - 1.75 mm max height

SMALL OUTLINE INTEGRATED CIRCUIT



LAND PATTERN EXAMPLE
 EXPOSED METAL SHOWN
 SCALE:8X



SOLDER MASK DETAILS

4214825/C 02/2019

NOTES: (continued)

- 6. Publication IPC-7351 may have alternate designs.
- 7. Solder mask tolerances between and around signal pads can vary based on board fabrication site.

EXAMPLE STENCIL DESIGN

D0008A

SOIC - 1.75 mm max height

SMALL OUTLINE INTEGRATED CIRCUIT



SOLDER PASTE EXAMPLE
BASED ON .005 INCH [0.125 MM] THICK STENCIL
SCALE:8X

4214825/C 02/2019

NOTES: (continued)

8. Laser cutting apertures with trapezoidal walls and rounded corners may offer better paste release. IPC-7525 may have alternate design recommendations.
9. Board assembly site may have different recommendations for stencil design.

P (R-PDIP-T8)

PLASTIC DUAL-IN-LINE PACKAGE



- NOTES:
- A. All linear dimensions are in inches (millimeters).
 - B. This drawing is subject to change without notice.
 - C. Falls within JEDEC MS-001 variation BA.

N (R-PDIP-T**)

PLASTIC DUAL-IN-LINE PACKAGE

16 PINS SHOWN



- NOTES:
- A. All linear dimensions are in inches (millimeters).
 - B. This drawing is subject to change without notice.
 - Falls within JEDEC MS-001, except 18 and 20 pin minimum body length (Dim A).
 - The 20 pin end lead shoulder width is a vendor option, either half or full width.

PACKAGE OUTLINE

JG0008A

CDIP - 5.08 mm max height

CERAMIC DUAL IN-LINE PACKAGE

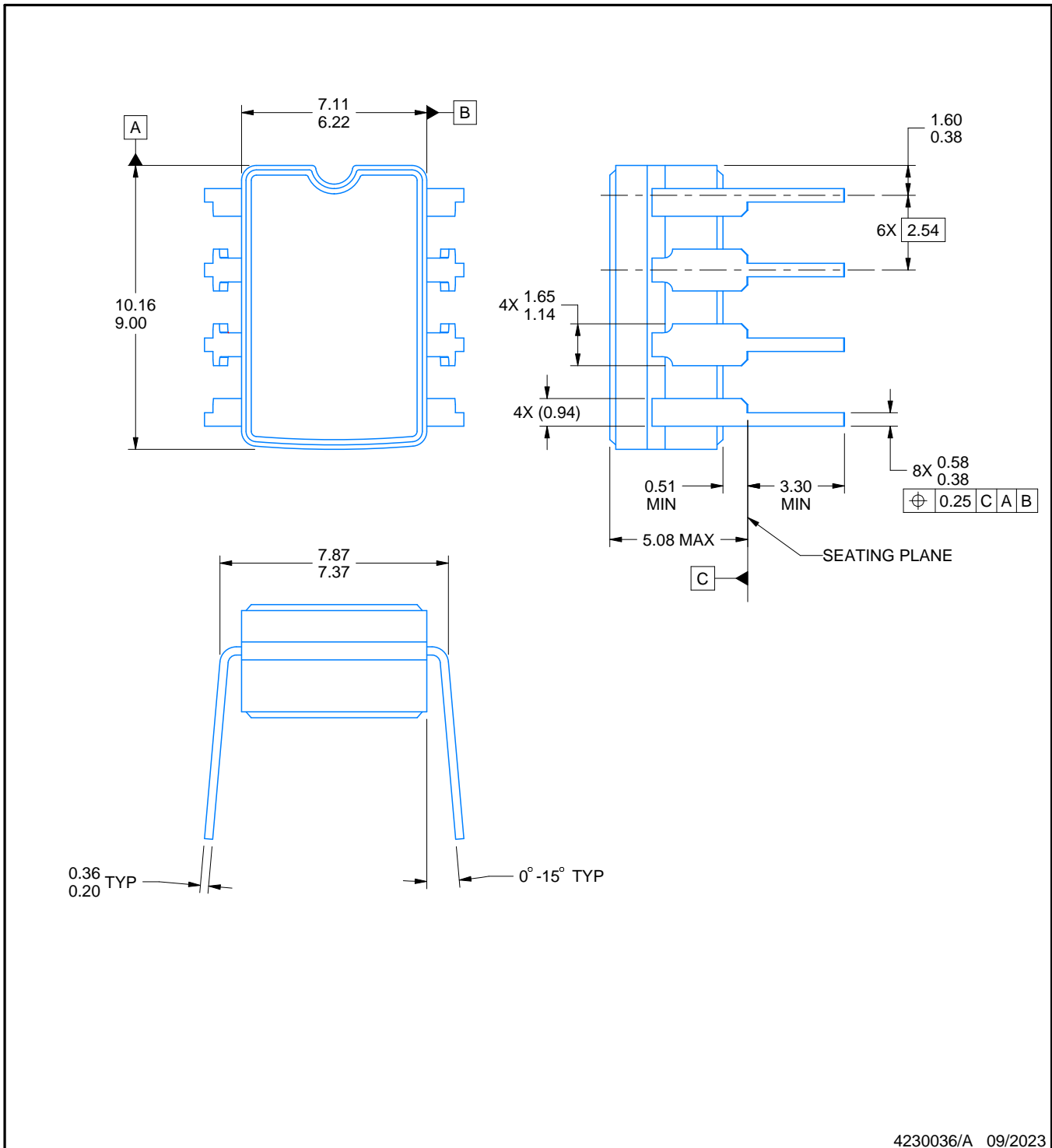

4230036/A 09/2023

NOTES:

1. All linear dimensions are in millimeters. Any dimensions in parenthesis are for reference only. Dimensioning and tolerancing per ASME Y14.5M.
2. This drawing is subject to change without notice.
3. This package can be hermetically sealed with a ceramic lid using glass frit.
4. Index point is provided on cap for terminal identification.
5. Falls within MIL STD 1835 GDIP1-T8

EXAMPLE BOARD LAYOUT

JG0008A

CDIP - 5.08 mm max height

CERAMIC DUAL IN-LINE PACKAGE

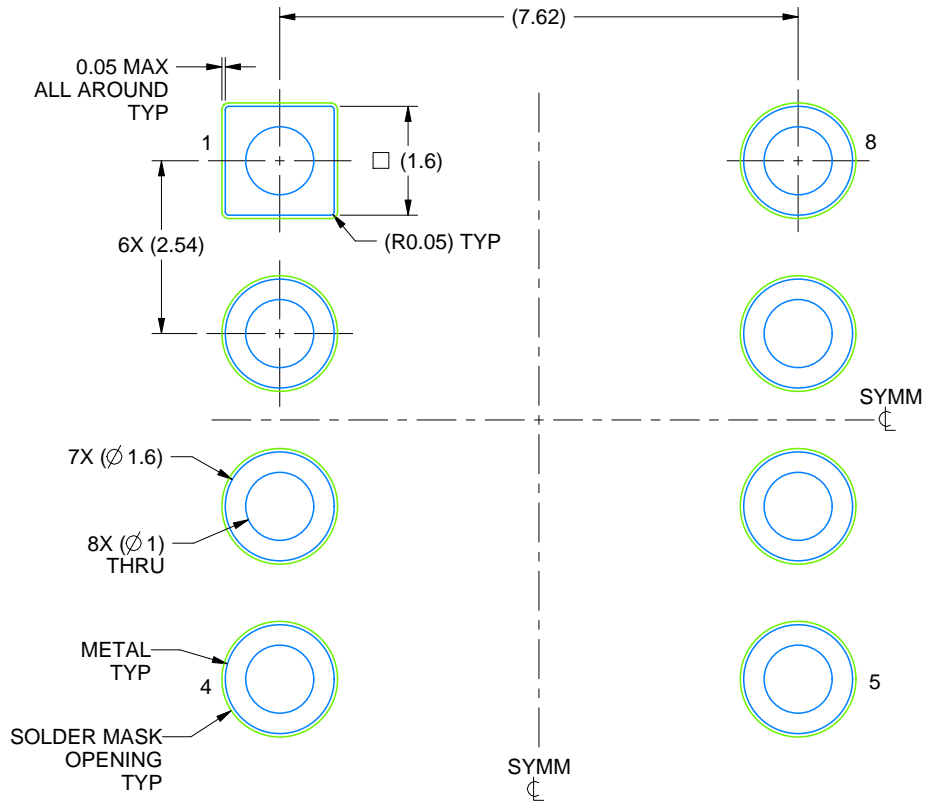

LAND PATTERN EXAMPLE
NON SOLDER MASK DEFINED
SCALE: 9X

4230036/A 09/2023

IMPORTANT NOTICE AND DISCLAIMER

TI PROVIDES TECHNICAL AND RELIABILITY DATA (INCLUDING DATASHEETS), DESIGN RESOURCES (INCLUDING REFERENCE DESIGNS), APPLICATION OR OTHER DESIGN ADVICE, WEB TOOLS, SAFETY INFORMATION, AND OTHER RESOURCES "AS IS" AND WITH ALL FAULTS, AND DISCLAIMS ALL WARRANTIES, EXPRESS AND IMPLIED, INCLUDING WITHOUT LIMITATION ANY IMPLIED WARRANTIES OF MERCHANTABILITY, FITNESS FOR A PARTICULAR PURPOSE OR NON-INFRINGEMENT OF THIRD PARTY INTELLECTUAL PROPERTY RIGHTS.

These resources are intended for skilled developers designing with TI products. You are solely responsible for (1) selecting the appropriate TI products for your application, (2) designing, validating and testing your application, and (3) ensuring your application meets applicable standards, and any other safety, security, regulatory or other requirements.

These resources are subject to change without notice. TI grants you permission to use these resources only for development of an application that uses the TI products described in the resource. Other reproduction and display of these resources is prohibited. No license is granted to any other TI intellectual property right or to any third party intellectual property right. TI disclaims responsibility for, and you fully indemnify TI and its representatives against any claims, damages, costs, losses, and liabilities arising out of your use of these resources.

TI's products are provided subject to [TI's Terms of Sale](#), [TI's General Quality Guidelines](#), or other applicable terms available either on ti.com or provided in conjunction with such TI products. TI's provision of these resources does not expand or otherwise alter TI's applicable warranties or warranty disclaimers for TI products. Unless TI explicitly designates a product as custom or customer-specified, TI products are standard, catalog, general purpose devices.

TI objects to and rejects any additional or different terms you may propose.

Copyright © 2026, Texas Instruments Incorporated

Last updated 10/2025