

TLV9024-EP and TLV9034-EP Enhanced Product High-Precision Quad Comparators

1 Features

- VID: V62/24640-01XE (TLV9024-EP)
- VID: V62/24640-02XE (TLV9034-EP)
- Enhanced Product
 - -55°C to 125°C Temperature Range
 - Plastic Package
 - Controlled Baseline
 - One Assembly and Test Site
 - One Fabrication Site
 - Extended Product Life Cycle
 - Product Traceability
- 1.65V to 5.5V supply range
- Precision input offset voltage $300\mu\text{V}$
- Rail-to-Rail input with fault-tolerance
- 100ns typical propagation delay
- Low quiescent current $25\mu\text{A}$ per channel
- 2kV ESD protection
- Open-drain output option (TLV9024-EP)
- Push-pull output option (TLV9034-EP)

2 Applications

- [Support Low Earth Orbit Space Applications](#)
- [Satellite Electrical Power Systems](#)
- [Flight Control Unit](#)
- [Communications Payload](#)

3 Description

The TLV9024-EP and TLV9034-EP are a family of quad channel comparators which offer low input offset voltage, fault-tolerant inputs with an excellent speed-to-power combination with a propagation delay of 100ns. Operating voltage range of 1.65V to 5.5V with a quiescent supply current of $25\mu\text{A}$ per channel.

These comparators also feature no output phase inversion with fault-tolerant inputs that can go up to 6V without damage.

The TLV9024-EP comparator has an open-drain output stage that can be pulled below or beyond the supply voltage, an excellent choice for level translation.

The TLV9034-EP comparator has a push-pull output stage capable of both sinking and sourcing current.

The TLV9024-EP and TLV9034-EP are specified for the extended temperature range of -55°C to $+125^{\circ}\text{C}$.

Device Information

PART NUMBER	PACKAGE (1)	BODY SIZE (NOM)
TLV9024-EP, TLV9034-EP	SOT-23 (14)	4.2mm x 2.0mm

(1) For all available packages, see the orderable addendum at the end of the data sheet.

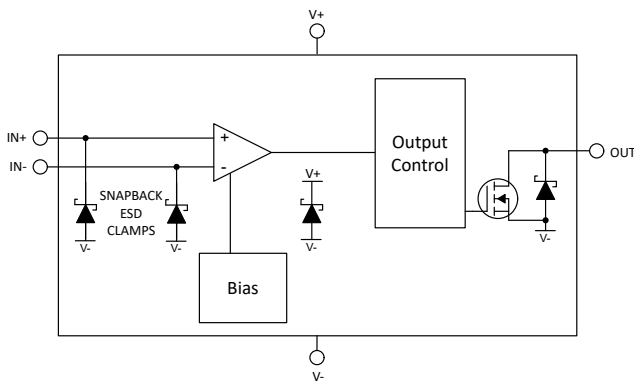

Open Drain Output Block Diagram

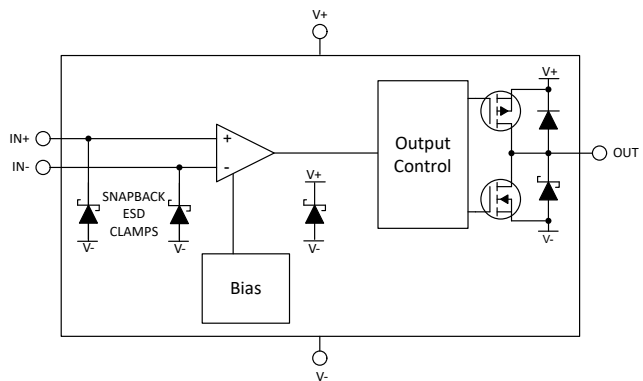

Push-Pull Output Block Diagram

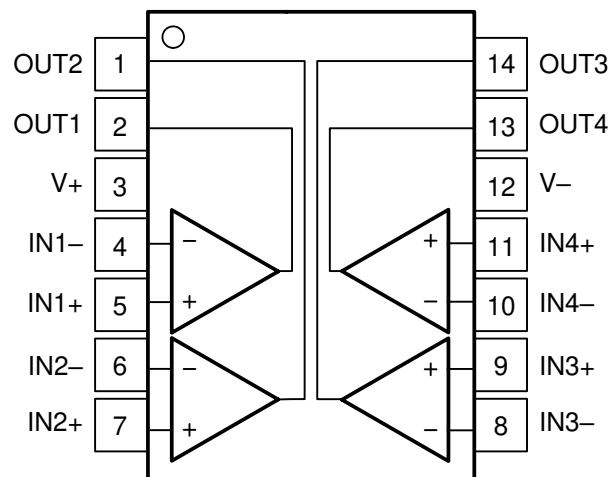

Table of Contents

1 Features	1	7.4 Device Functional Modes.....	19
2 Applications	1	8 Application and Implementation	22
3 Description	1	8.1 Application Information.....	22
4 Pin Configuration and Functions	3	8.2 Typical Applications.....	25
4.1 Pin Functions:TLV9024-EP and TLV9034-EP Quad.....	3	8.3 Power Supply Recommendations.....	32
5 Specifications	4	9 Layout	33
5.1 Absolute Maximum Ratings.....	4	9.1 Layout Guidelines.....	33
5.2 ESD Ratings.....	4	9.2 Layout Example.....	33
5.3 Recommended Operating Conditions.....	4	10 Device and Documentation Support	34
5.4 Thermal Information, TLV90X4-EP	4	10.1 Documentation Support.....	34
5.5 Electrical Characteristics.....	5	10.2 Receiving Notification of Documentation Updates..	34
5.6 Switching Characteristics.....	6	10.3 Support Resources.....	34
5.7 Typical Characteristics.....	7	10.4 Trademarks.....	34
6 Typical Characteristics	13	10.5 Electrostatic Discharge Caution.....	34
7 Detailed Description	19	10.6 Glossary.....	34
7.1 Overview.....	19	11 Revision History	34
7.2 Functional Block Diagram.....	19	12 Mechanical, Packaging, and Orderable Information	35
7.3 Feature Description.....	19		

4 Pin Configuration and Functions

4.1 Pin Functions: TLV9024-EP and TLV9034-EP Quad



**Figure 4-1. DYY,
14-Pin SOT-23,
Top View**

Table 4-1. Pin Functions: TLV9024-EP and TLV9034-EP Quad

PIN		I/O	DESCRIPTION
NAME	NO.		
OUT2	1	O	Output pin of the comparator 2
OUT1	2	O	Output pin of the comparator1
V+	3	—	Positive supply
IN1-	4	I	Negative input pin of the comparator 1
IN1+	5	I	Positive input pin of the comparator 1
IN2-	6	I	Negative input pin of the comparator 2
IN2+	7	I	Positive input pin of the comparator 2
IN3-	8	I	Negative input pin of the comparator 3
IN3+	9	I	Positive input pin of the comparator 3
IN4-	10	I	Negative input pin of the comparator 4
IN4+	11	I	Positive input pin of the comparator 4
V-	12	—	Negative supply
OUT4	13	O	Output pin of the comparator 4
OUT3	14	O	Output pin of the comparator 3

5 Specifications

5.1 Absolute Maximum Ratings

over operating free-air temperature range (unless otherwise noted)⁽¹⁾

	MIN	MAX	UNIT
Supply voltage: $V_S = (V+) - (V-)$	-0.3	6	V
Input pins (IN+, IN-) from (V-) ⁽²⁾	-0.3	6	V
Current into Input pins (IN+, IN-)	-10	10	mA
Output (OUT) from (V-), open-drain only ⁽³⁾	-0.3	6	V
Output (OUT) from (V-), push-pull only	-0.3	(V+) + 0.3	V
Output short circuit duration ⁽⁴⁾		10	s
Junction temperature, T_J		150	°C
Storage temperature, T_{stg}	-65	150	°C

- (1) Operation outside the Absolute Maximum Ratings can cause permanent device damage. Absolute Maximum Ratings do not imply functional operation of the device at these or any other conditions beyond those listed under Recommended Operating Conditions. If used outside the Recommended Operating Conditions but within the Absolute Maximum Ratings, the device may not be fully functional, and this can affect device reliability, functionality, performance, and shorten the device lifetime.
- (2) Input terminals are diode-clamped to (V-). Input signals that can swing more than 0.3V beyond the supply rails must be current-limited to 10mA or less. Additionally, Inputs (IN+, IN-) can be greater than (V+) and OUT as long as input is within the -0.3V to 6V range
- (3) Output (OUT) for open drain can be greater than (V+) and inputs (IN+, IN-) as long as the input is within the -0.3V to 6V range
- (4) Short-circuit to (V-) or (V+).

5.2 ESD Ratings

		VALUE	UNIT
V_{ESD}	Electrostatic discharge	Human-body model (HBM), per ANSI/ESDA/JEDEC JS-001 ⁽¹⁾	±2000
		Charged-device model (CDM), per JEDEC specification JESD22-C101 ⁽²⁾	±1000

- (1) JEDEC document JEP155 states that 500V HBM allows safe manufacturing with a standard ESD control process.
- (2) JEDEC document JEP157 states that 250V CDM allows safe manufacturing with a standard ESD control process.

5.3 Recommended Operating Conditions

over operating free-air temperature range (unless otherwise noted)

	MIN	MAX	UNIT
Supply voltage: $V_S = (V+) - (V-)$	1.65	5.5	V
Input voltage range (IN+, IN-) from (V-)	-0.2	5.7	V
Ambient temperature, T_A	-55	125	°C

5.4 Thermal Information, TLV90X4-EP

THERMAL METRIC ⁽¹⁾		TLV9024-EP, TLV9034-EP,	UNIT
		DYY (SOT23)	
		14 PINS	
R_{qJA}	Junction-to-ambient thermal resistance	218.1	°C/W
$R_{qJC(top)}$	Junction-to-case (top) thermal resistance	127.0	°C/W
R_{qJB}	Junction-to-board thermal resistance	129.6	°C/W
γ_{JT}	Junction-to-top characterization parameter	24.7	°C/W
γ_{JB}	Junction-to-board characterization parameter	126.8	°C/W
$R_{qJC(bot)}$	Junction-to-case (bottom) thermal resistance	–	°C/W

- (1) For more information about traditional and new thermal metrics, see the [Semiconductor and IC Package Thermal Metrics](#) appnote.

5.5 Electrical Characteristics

For V_S (Total Supply Voltage) = (V+) – (GND) = 5V, V_{CM} = (GND) at T_A = 25°C (Unless otherwise noted)

PARAMETER		TEST CONDITIONS	MIN	TYP	MAX	UNIT
OFFSET VOLTAGE						
V_{OS}	Input offset voltage	$V_S = 1.8V$ and 5V	-1.5	±0.3	1.5	mV
V_{OS}	Input offset voltage	$V_S = 1.8V$ and 5V, $T_A = -55^\circ C$ to $+125^\circ C$	-2		2	
dV_{IO}/dT	Input offset voltage drift	$V_S = 1.8V$ and 5V, $T_A = -55^\circ C$ to $+125^\circ C$		±0.5		$\mu V/^\circ C$
POWER SUPPLY						
I_Q	Quiescent current per comparator	$V_S = 1.8V$ and 5V, No Load, Output Low		25	35	μA
I_Q	Quiescent current per comparator	$V_S = 1.8V$ and 5V, No Load, Output Low, $T_A = -55^\circ C$ to $+125^\circ C$			40	
PSRR	Power-supply rejection ratio	$V_S = 1.8V$ to 5V, $T_A = -55^\circ C$ to $+125^\circ C$		95		dB
INPUT BIAS CURRENT						
I_B	Input bias current	$V_{CM} = V_S/2$		5		pA
I_{OS}	Input offset current	$V_{CM} = V_S/2$		1		pA
INPUT CAPACITANCE						
C_{ID}	Input Capacitance, Differential	$V_{CM} = V_S/2$		2		pF
C_{IC}	Input Capacitance, Common Mode	$V_{CM} = V_S/2$		3		pF
INPUT VOLTAGE RANGE						
$V_{CM-Range}$	Common-mode voltage range	$V_S = 1.8V$ and 5V, $T_A = -55^\circ C$ to $+125^\circ C$	(V-) – 0.2		(V+) + 0.2	V
CMRR	Common-mode rejection ratio	$V_S = 5V$, (V-) < V_{CM} < (V+ - 1.5), $T_A = -55^\circ C$ to $+125^\circ C$		70		dB
OPEN-LOOP GAIN						
A_{VD}	Large signal differential voltage amplification	For open-drain version only		200		V/mV
OUTPUT						
V_{OL}	Voltage swing from (V-)	$I_{SINK} = 4mA$, $T_A = 25^\circ C$		75	125	mV
V_{OL}	Voltage swing from (V-)	$I_{SINK} = 4mA$, $T_A = -55^\circ C$ to $+125^\circ C$			175	mV
V_{OH}	Voltage swing from (V+)	$I_{SOURCE} = 4mA$, $T_A = 25^\circ C$ (push-pull only)		75	125	mV
V_{OH}	Voltage swing from (V+)	$I_{SOURCE} = 4mA$, $T_A = -55^\circ C$ to $+125^\circ C$ (push-pull only)			175	mV
I_{LKG}	Open-drain output leakage current	$V_{PULLUP} = (V+)$, $T_A = 25^\circ C$ (open drain only)		100		pA
I_{SC}	Short-circuit current	$V_S = 5V$, Sinking	90	100		mA
I_{SC}	Short-circuit current	$V_S = 5V$, Sourcing (push-pull only)	90	100		mA

5.6 Switching Characteristics

For V_S (Total Supply Voltage) = $(V+) - (GND) = 5V$, $V_{CM} = V_S / 2$, $C_L = 15pF$ at $T_A = 25^\circ C$ (Unless otherwise noted)

PARAMETER		TEST CONDITIONS	MIN	TYP	MAX	UNIT
OUTPUT						
T_{PD-HL}	Propagation delay time, high-to-low	$V_{ID} = -100mV$; Delay from mid-point of input to mid-point of output ($R_P = 2.5K\Omega$ for open drain only)		100		ns
T_{PD-LH}	Propagation delay time, low-to-high	$V_{ID} = 100mV$; Delay from mid-point of input to mid-point of output (for push-pull only)		115		ns
T_{PD-LH}	Propagation delay time, low-to-high	$V_{ID} = 100mV$; Delay from mid-point of input to mid-point of output ($R_P = 2.5K\Omega$ for open drain only)		150		ns
T_{FALL}	5V Output Fall Time, 80% to 20%	$V_{ID} = -100mV$		3		ns
T_{RISE}	5V Output Rise Time, 20% to 80%	$V_{ID} = 100mV$, for push-pull only		3		ns
F_{TOGGLE}	5V, Toggle Frequency	$V_{ID} = 100mV$ ($R_P = 2.5K\Omega$ for open drain only)		3		MHz
POWER ON TIME						
P_{ON}	Power on-time	$V_S = 1.8V$ and $5V$, $V_{CM} = (V-)$, $V_{ID} = -0.1V$, $V_{PULL-UP} = V_S / 2$, Delay from $V_S / 2$ to $V_{OUT} = 0.1 \times V_S / 2$ ($R_P = 2.5K\Omega$ for open drain only)		30		μs

5.7 Typical Characteristics

$T_A = 25^\circ\text{C}$, $V_S = 5\text{V}$, $R_{\text{PULLUP}} = 2.5\text{k}$, $C_L = 15\text{pF}$, $V_{\text{CM}} = 0\text{V}$, $V_{\text{UNDERDRIVE}} = 100\text{mV}$, $V_{\text{OVERDRIVE}} = 100\text{mV}$ unless otherwise noted.

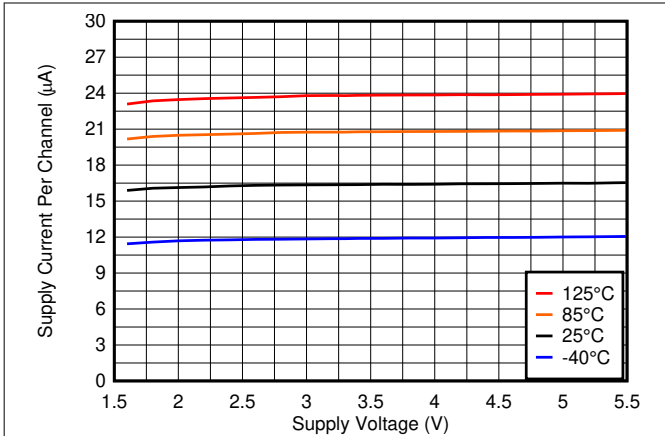

Figure 5-1. Supply Current vs. Supply Voltage

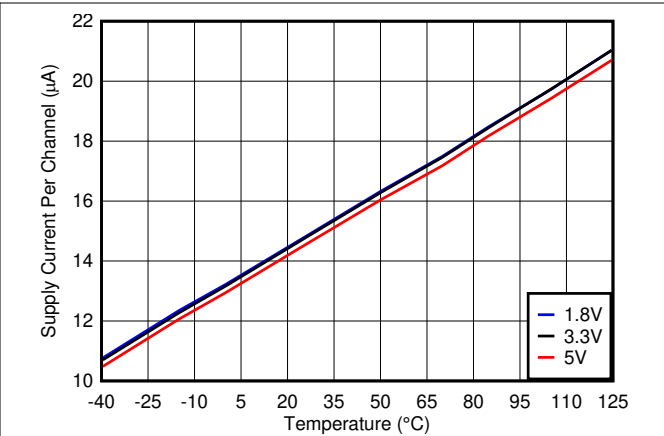

Figure 5-2. Supply Current vs. Temperature

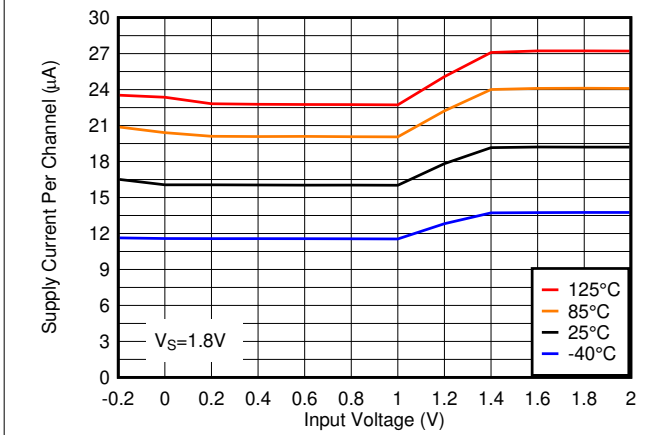

Figure 5-3. Supply Current vs. Input Voltage, 1.8V

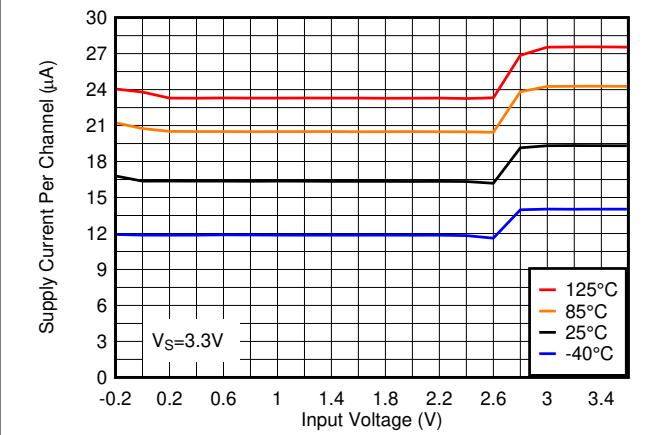

Figure 5-4. Supply Current vs. Input Voltage, 3.3V

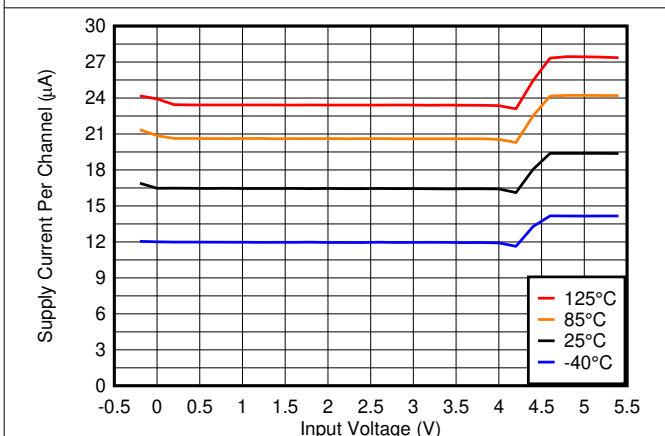

Figure 5-5. Supply Current vs. Input Voltage, 5V

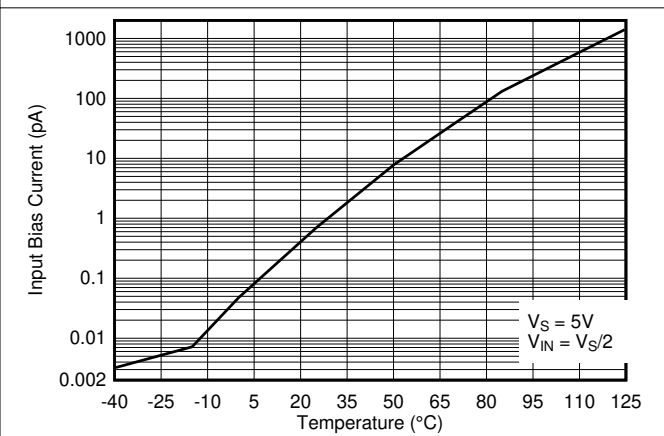

Figure 5-6. Input Bias Current vs. Temperature

5.7 Typical Characteristics (continued)

$T_A = 25^\circ\text{C}$, $V_S = 5\text{V}$, $R_{\text{PULLUP}} = 2.5\text{k}$, $C_L = 15\text{pF}$, $V_{\text{CM}} = 0\text{V}$, $V_{\text{UNDERDRIVE}} = 100\text{mV}$, $V_{\text{OVERDRIVE}} = 100\text{mV}$ unless otherwise noted.

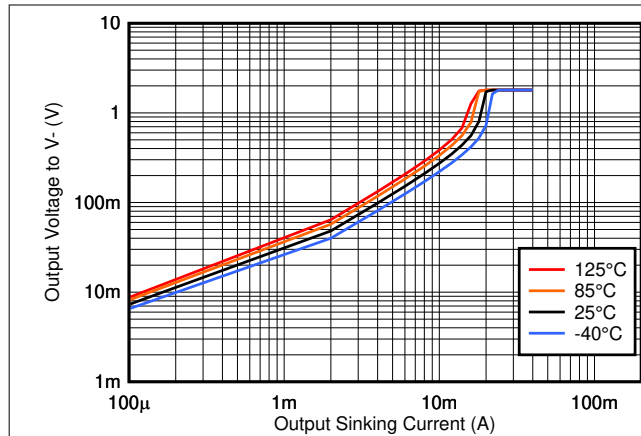

Figure 5-7. Output Sinking Current vs. Output Voltage, 1.8V

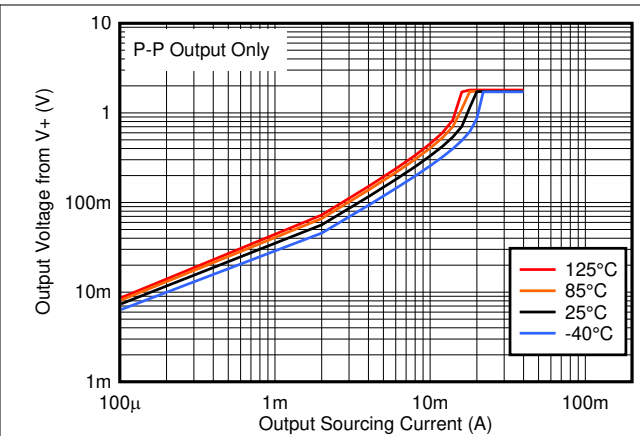

Figure 5-8. Output Sourcing Current vs. Output Voltage, 1.8V

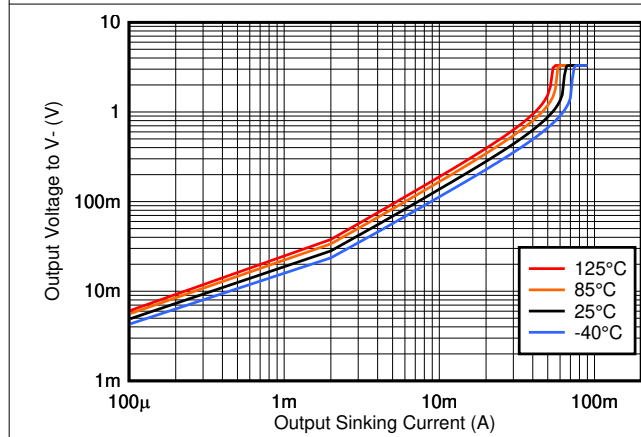

Figure 5-9. Output Sinking Current vs. Output Voltage, 3.3V

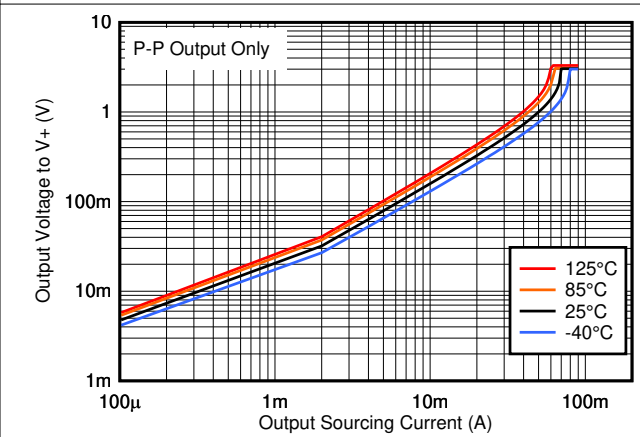

Figure 5-10. Output Sourcing Current vs. Output Voltage, 3.3V

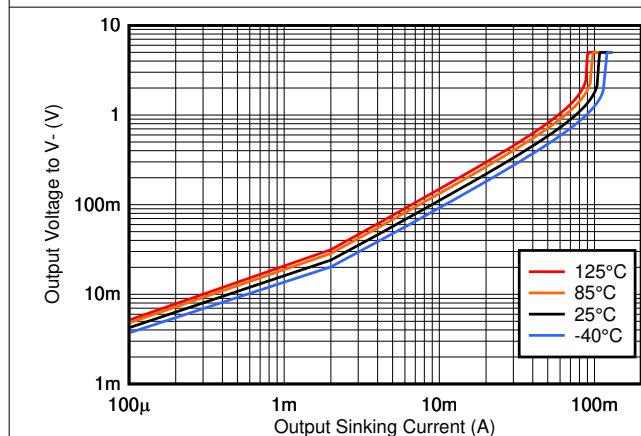

Figure 5-11. Output Sinking Current vs. Output Voltage, 5V

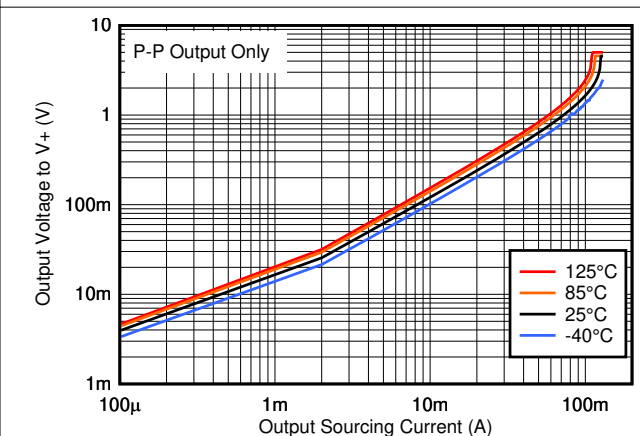

Figure 5-12. Output Sourcing Current vs. Output Voltage, 5V

5.7 Typical Characteristics (continued)

$T_A = 25^\circ\text{C}$, $V_S = 5\text{V}$, $R_{\text{PULLUP}} = 2.5\text{k}$, $C_L = 15\text{pF}$, $V_{\text{CM}} = 0\text{V}$, $V_{\text{UNDERDRIVE}} = 100\text{mV}$, $V_{\text{OVERDRIVE}} = 100\text{mV}$ unless otherwise noted.

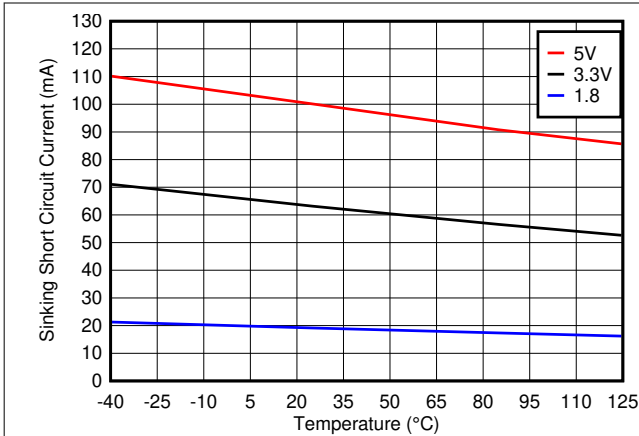

Figure 5-13. Sinking Short Circuit Current vs. Temperature

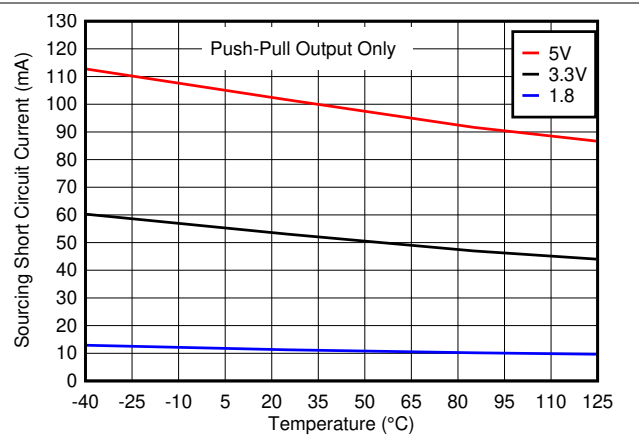

Figure 5-14. Sourcing Short Circuit Current vs. Temperature

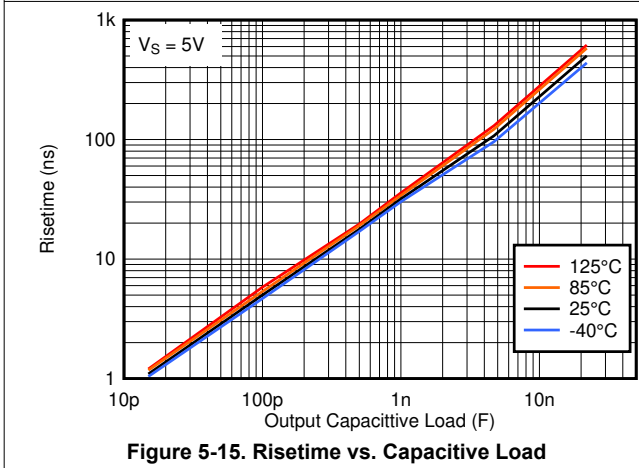

Figure 5-15. Risetime vs. Capacitive Load

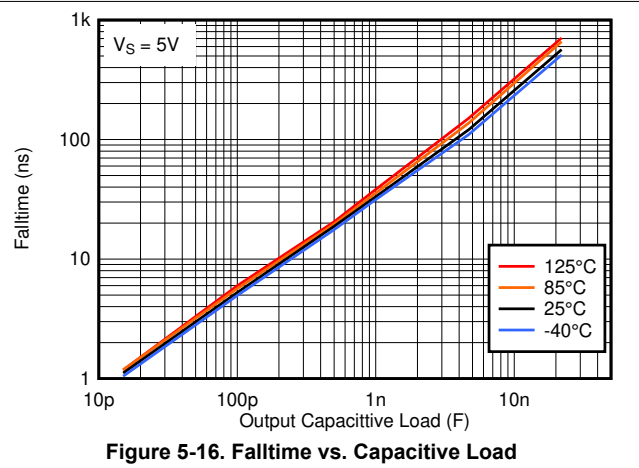

Figure 5-16. Falltime vs. Capacitive Load

5.7 Typical Characteristics (continued)

$T_A = 25^\circ\text{C}$, $V_S = 5\text{V}$, $R_{\text{PULLUP}} = 2.5\text{k}$, $C_L = 15\text{pF}$, $V_{\text{CM}} = 0\text{V}$, $V_{\text{UNDERDRIVE}} = 100\text{mV}$, $V_{\text{OVERDRIVE}} = 100\text{mV}$ unless otherwise noted.

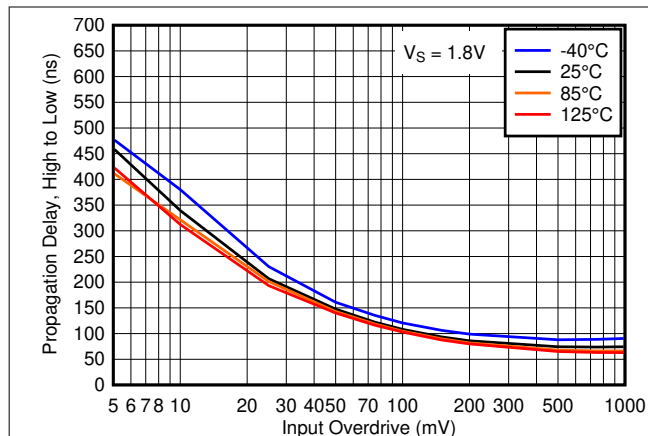

Figure 5-17. Propagation Delay, High to Low, 1.8V

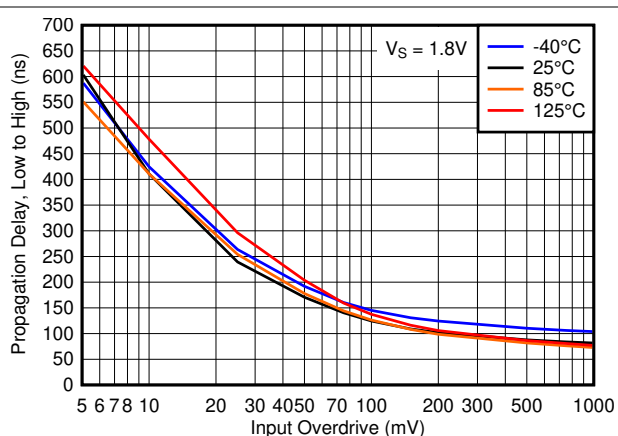

Figure 5-18. Propagation Delay, Low to High, 1.8V

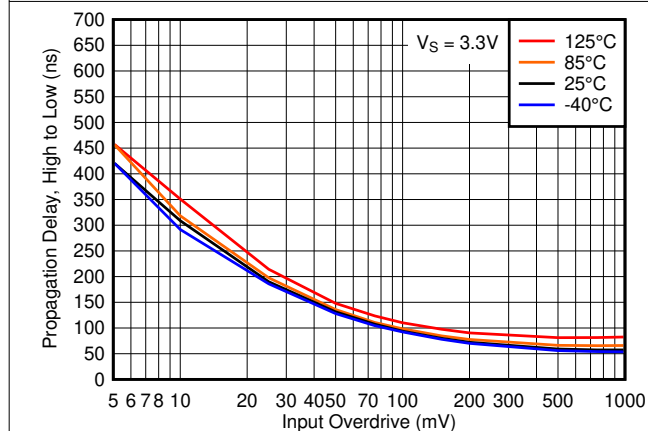

Figure 5-19. Propagation Delay, High to Low, 3.3V

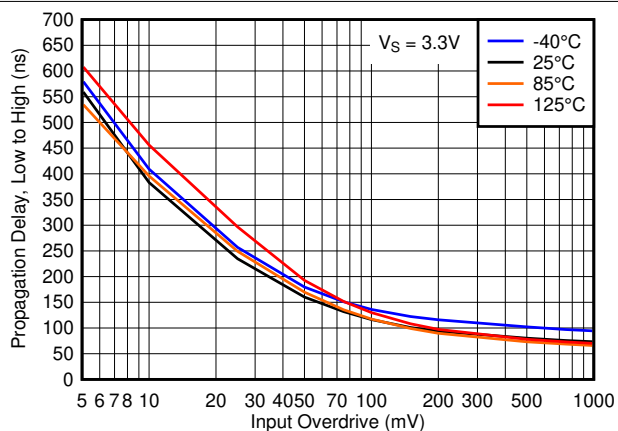

Figure 5-20. Propagation Delay, Low to High, 3.3V

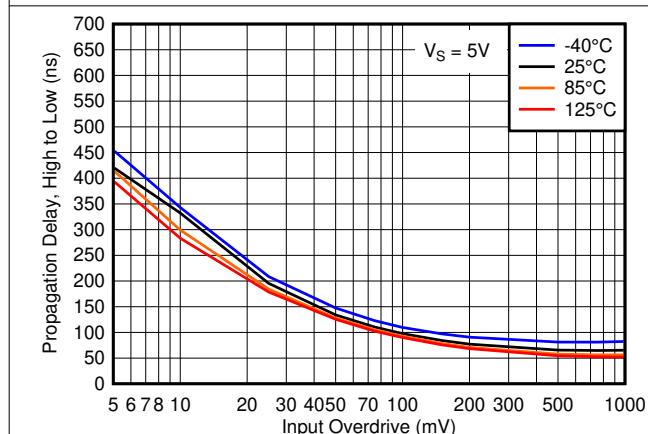

Figure 5-21. Propagation Delay, High to Low, 5V

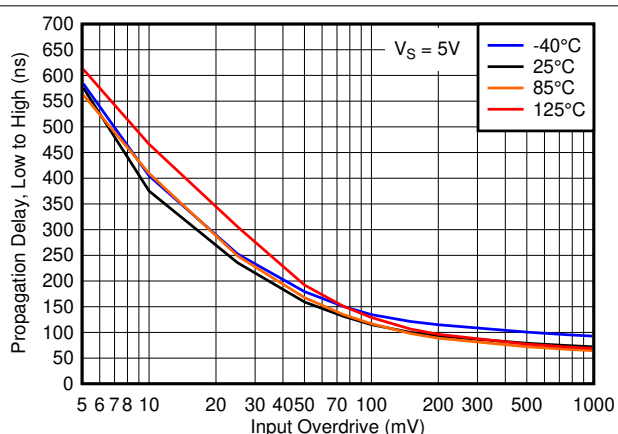

Figure 5-22. Propagation Delay, Low to High, 5V

5.7 Typical Characteristics (continued)

$T_A = 25^\circ\text{C}$, $V_S = 5\text{V}$, $R_{\text{PULLUP}} = 2.5\text{k}$, $C_L = 15\text{pF}$, $V_{\text{CM}} = 0\text{V}$, $V_{\text{UNDERDRIVE}} = 100\text{mV}$, $V_{\text{OVERDRIVE}} = 100\text{mV}$ unless otherwise noted.

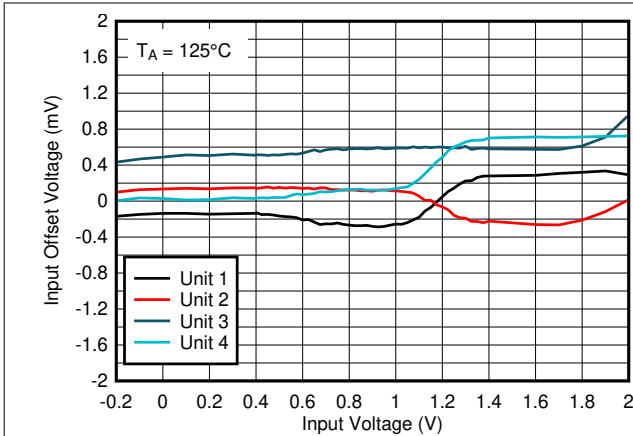

Figure 5-23. Offset Voltage vs. Input Voltage at 125°C, 1.8V

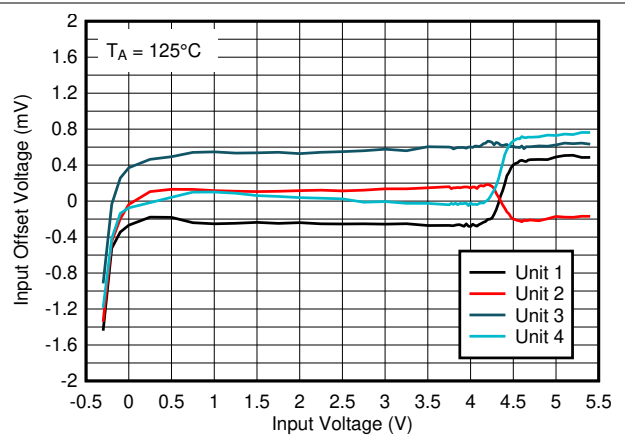

Figure 5-24. Offset Voltage vs. Input Voltage at 125°C, 5V

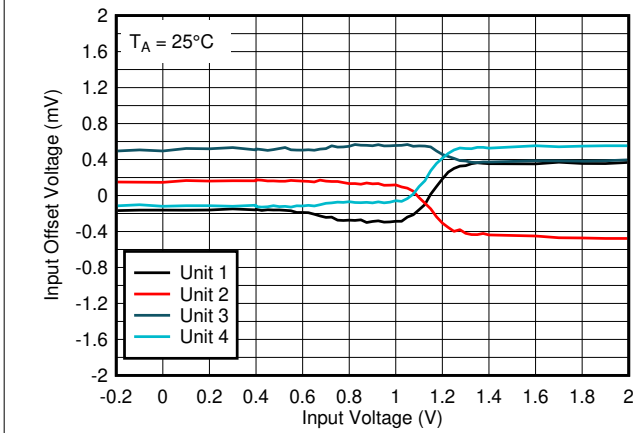

Figure 5-25. Offset Voltage vs. Input Voltage at 25°C, 1.8V

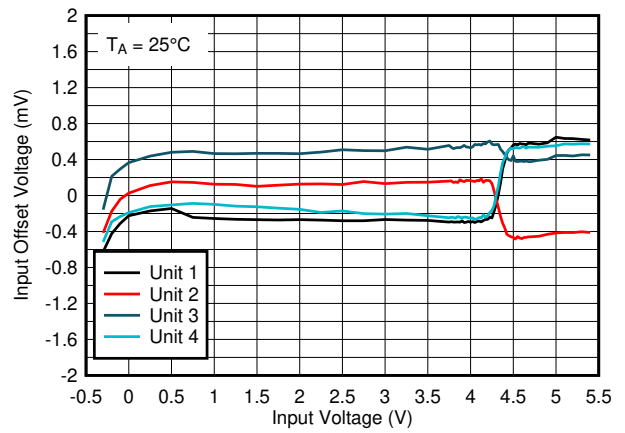

Figure 5-26. Offset Voltage vs. Input Voltage at 25°C, 5V

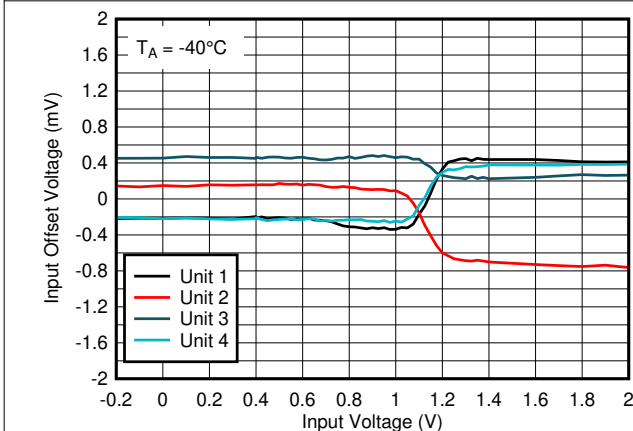

Figure 5-27. Offset Voltage vs. Input Voltage at -40°C, 1.8V

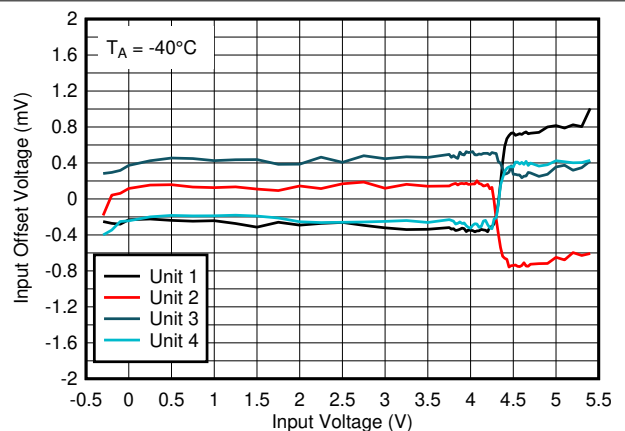

Figure 5-28. Offset Voltage vs. Input Voltage at -40°C, 5V

5.7 Typical Characteristics (continued)

$T_A = 25^\circ\text{C}$, $V_S = 5\text{V}$, $R_{\text{PULLUP}} = 2.5\text{k}$, $C_L = 15\text{pF}$, $V_{\text{CM}} = 0\text{V}$, $V_{\text{UNDERDRIVE}} = 100\text{mV}$, $V_{\text{OVERDRIVE}} = 100\text{mV}$ unless otherwise noted.

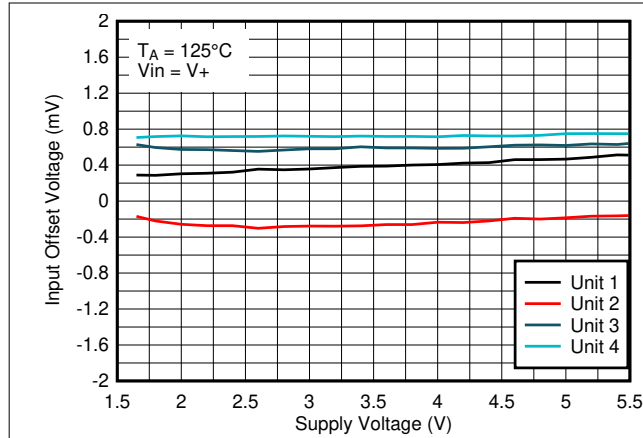

Figure 5-29. Offset Voltage vs. Supply Voltage at 125°C , $V_{\text{IN}}=V_+$

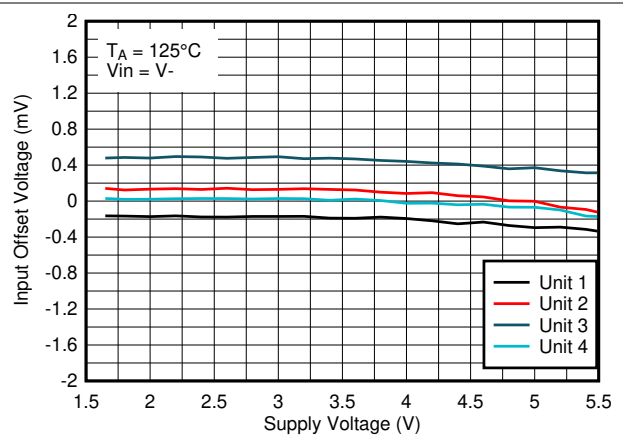

Figure 5-30. Offset Voltage vs. Supply Voltage at 125°C , $V_{\text{IN}}=V_-$

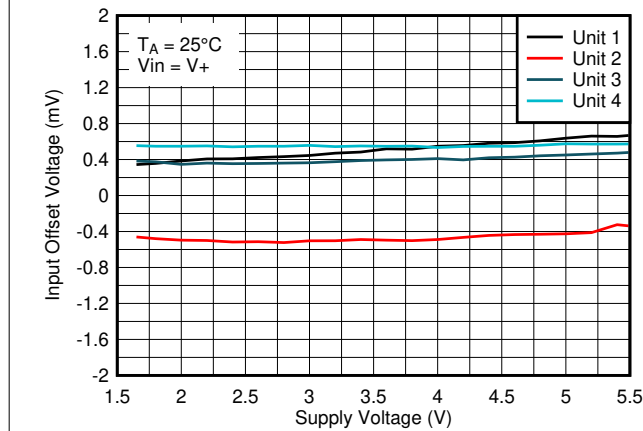

Figure 5-31. Offset Voltage vs. Supply Voltage at 25°C , $V_{\text{IN}}=V_+$

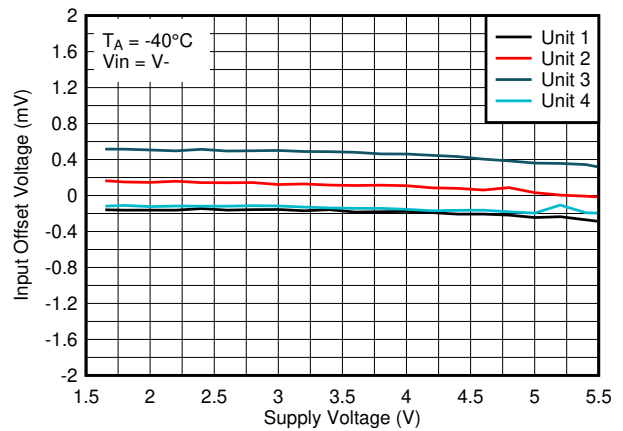

Figure 5-32. Offset Voltage vs. Supply Voltage at 25°C , $V_{\text{IN}}=V_-$

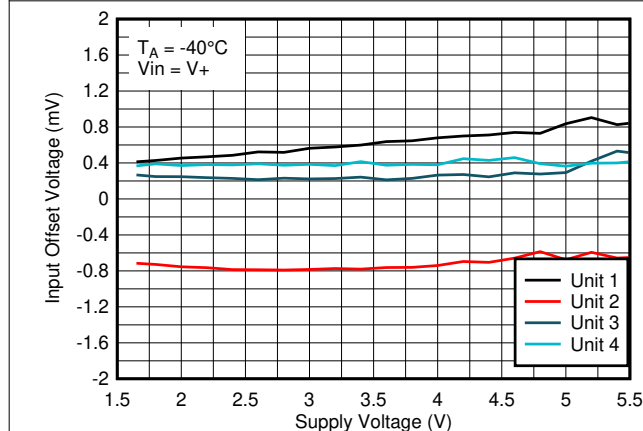

Figure 5-33. Offset Voltage vs. Supply Voltage at -40°C , $V_{\text{IN}}=V_+$

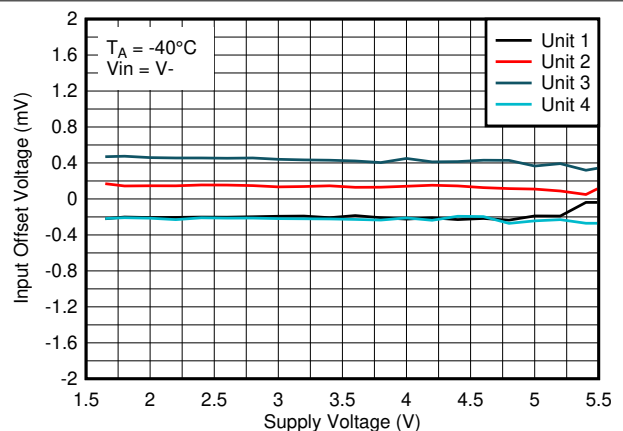

Figure 5-34. Offset Voltage vs. Supply Voltage at -40°C , $V_{\text{IN}}=V_-$

6 Typical Characteristics

$T_A = 25^\circ\text{C}$, $V_S = 5\text{V}$, $R_{\text{PULLUP}} = 2.5\text{k}$, $C_L = 15\text{pF}$, $V_{\text{CM}} = 0\text{V}$, $V_{\text{UNDERDRIVE}} = 100\text{mV}$, $V_{\text{OVERDRIVE}} = 100\text{mV}$ unless otherwise noted.

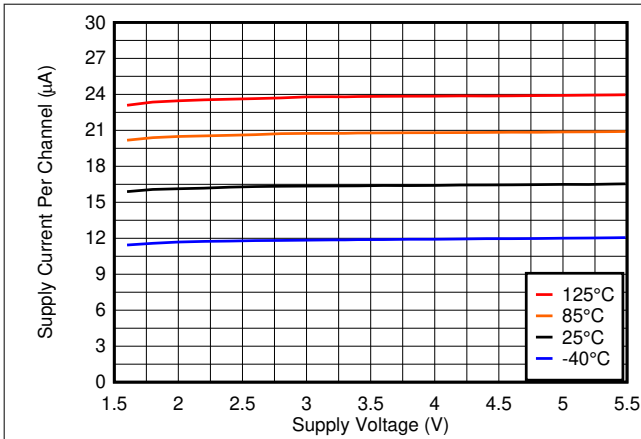

Figure 6-1. Supply Current vs. Supply Voltage

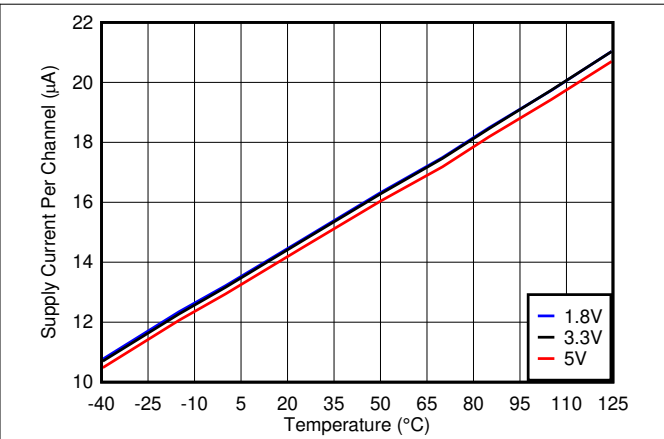

Figure 6-2. Supply Current vs. Temperature

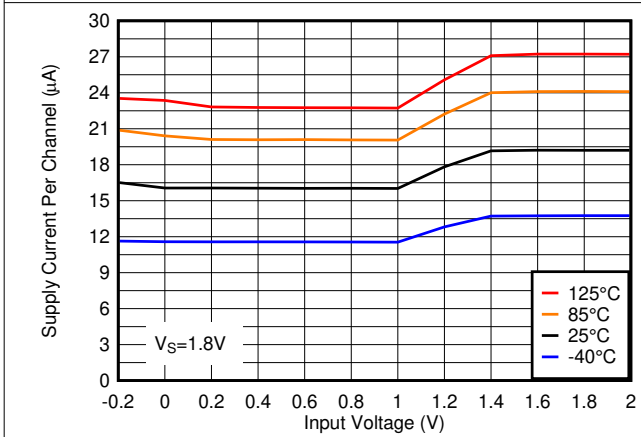

Figure 6-3. Supply Current vs. Input Voltage, 1.8V

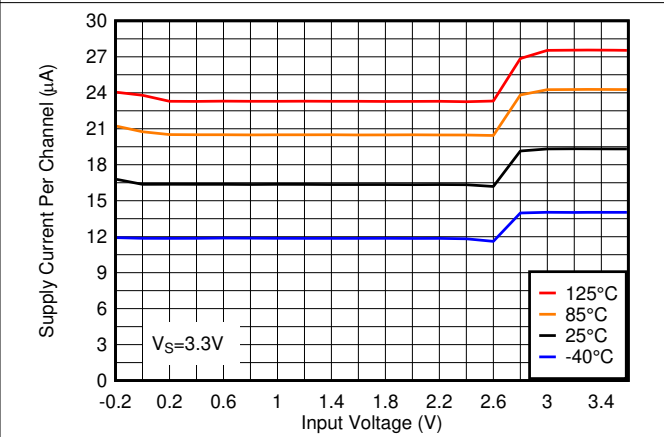

Figure 6-4. Supply Current vs. Input Voltage, 3.3V

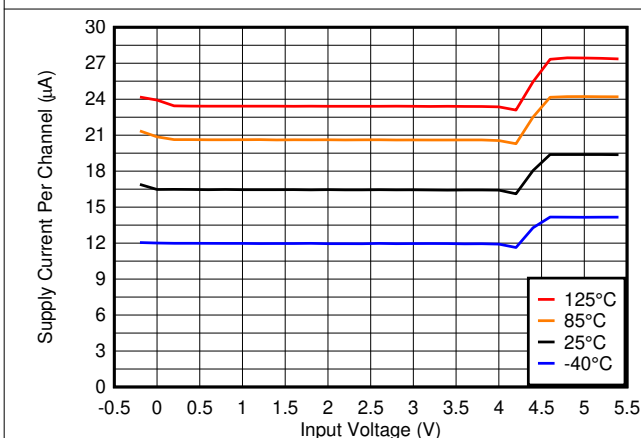

Figure 6-5. Supply Current vs. Input Voltage, 5V

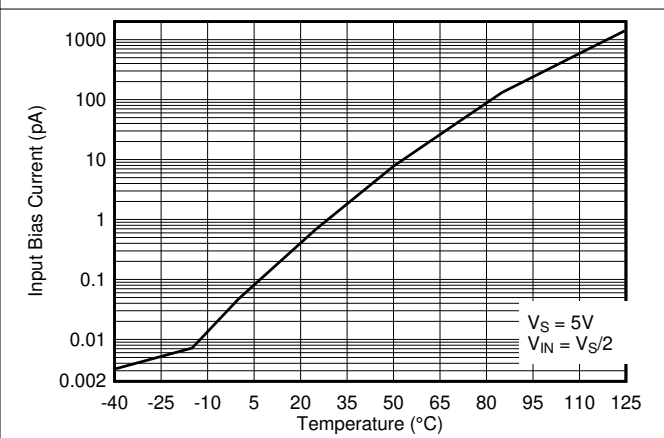

Figure 6-6. Input Bias Current vs. Temperature

6 Typical Characteristics (continued)

$T_A = 25^\circ\text{C}$, $V_S = 5\text{V}$, $R_{\text{PULLUP}} = 2.5\text{k}$, $C_L = 15\text{pF}$, $V_{\text{CM}} = 0\text{V}$, $V_{\text{UNDERDRIVE}} = 100\text{mV}$, $V_{\text{OVERDRIVE}} = 100\text{mV}$ unless otherwise noted.

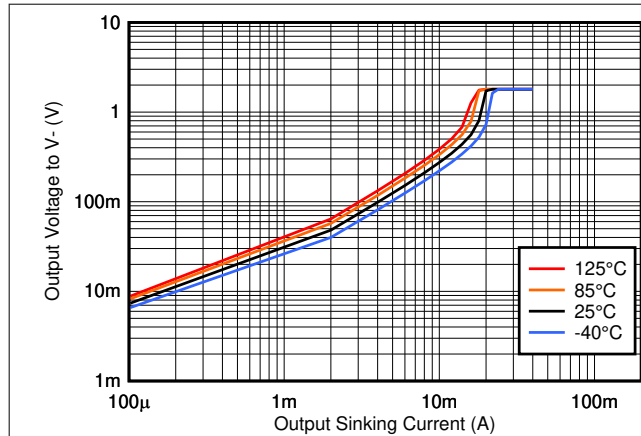

Figure 6-7. Output Sinking Current vs. Output Voltage, 1.8V

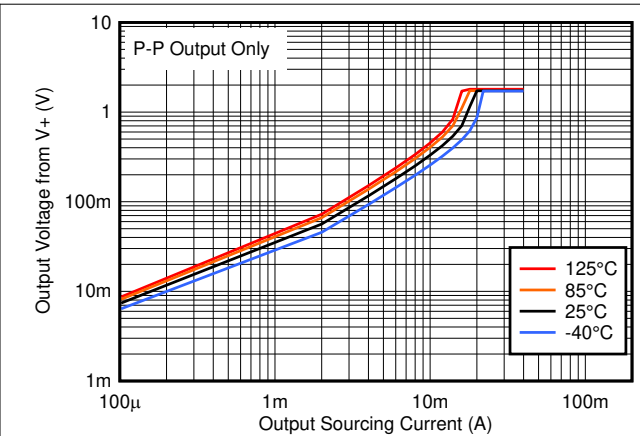

Figure 6-8. Output Sourcing Current vs. Output Voltage, 1.8V

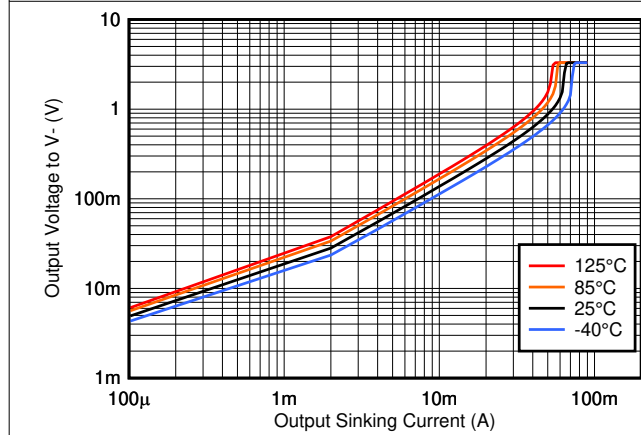

Figure 6-9. Output Sinking Current vs. Output Voltage, 3.3V

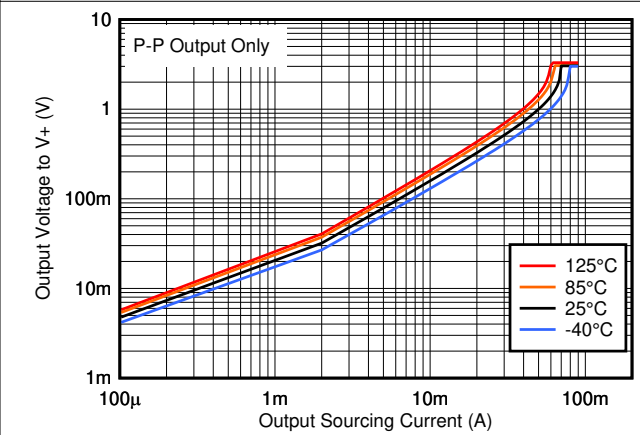

Figure 6-10. Output Sourcing Current vs. Output Voltage, 3.3V

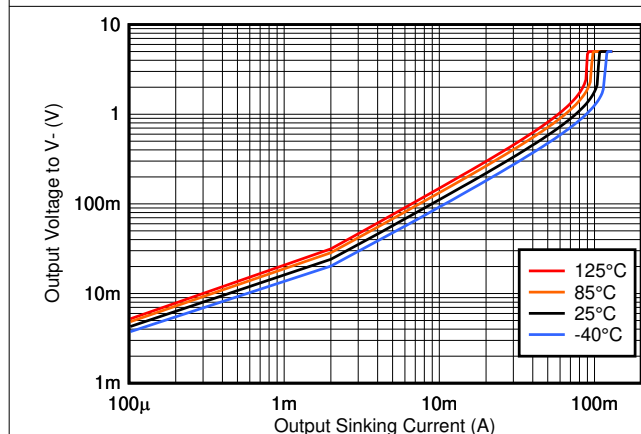

Figure 6-11. Output Sinking Current vs. Output Voltage, 5V

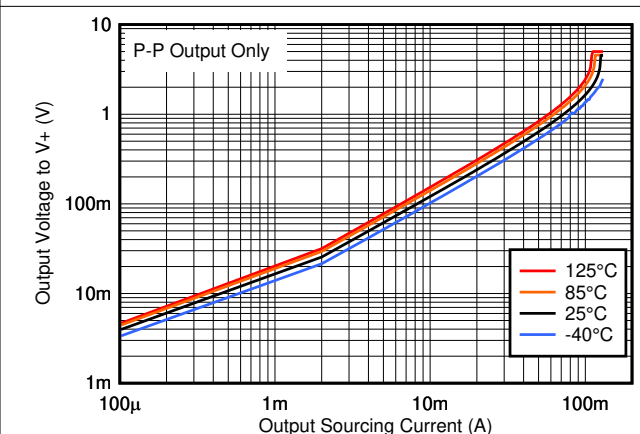

Figure 6-12. Output Sourcing Current vs. Output Voltage, 5V

6 Typical Characteristics (continued)

$T_A = 25^\circ\text{C}$, $V_S = 5\text{V}$, $R_{\text{PULLUP}} = 2.5\text{k}$, $C_L = 15\text{pF}$, $V_{\text{CM}} = 0\text{V}$, $V_{\text{UNDERDRIVE}} = 100\text{mV}$, $V_{\text{OVERDRIVE}} = 100\text{mV}$ unless otherwise noted.

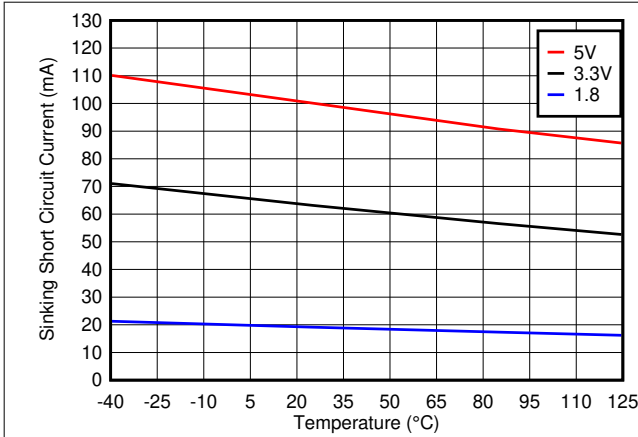

Figure 6-13. Sinking Short Circuit Current vs. Temperature

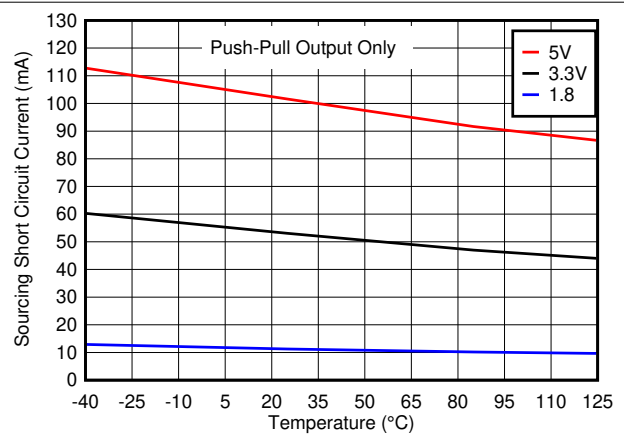

Figure 6-14. Sourcing Short Circuit Current vs. Temperature

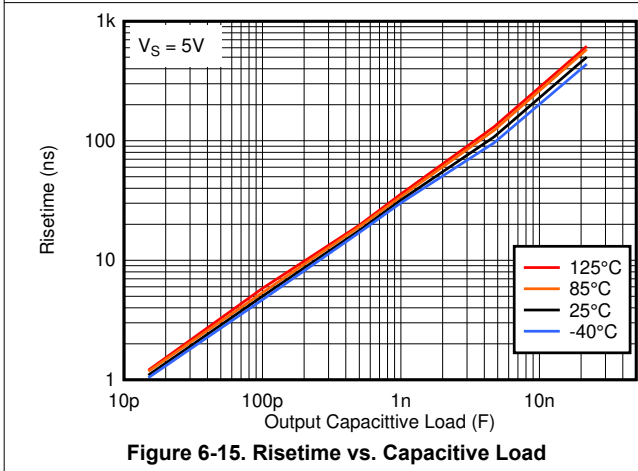

Figure 6-15. Risetime vs. Capacitive Load

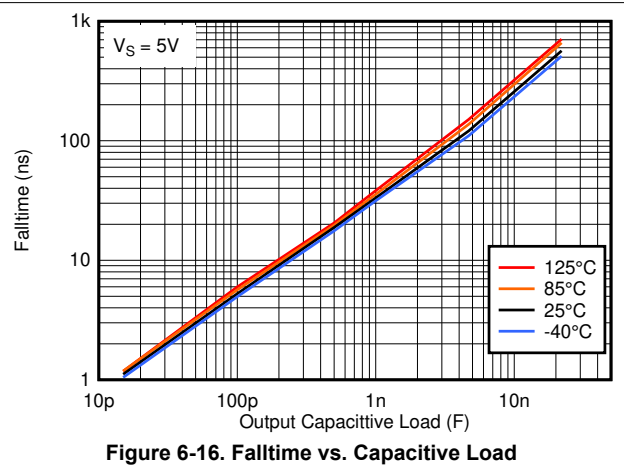

Figure 6-16. Falltime vs. Capacitive Load

6 Typical Characteristics (continued)

$T_A = 25^\circ\text{C}$, $V_S = 5\text{V}$, $R_{\text{PULLUP}} = 2.5\text{k}$, $C_L = 15\text{pF}$, $V_{\text{CM}} = 0\text{V}$, $V_{\text{UNDERDRIVE}} = 100\text{mV}$, $V_{\text{OVERDRIVE}} = 100\text{mV}$ unless otherwise noted.

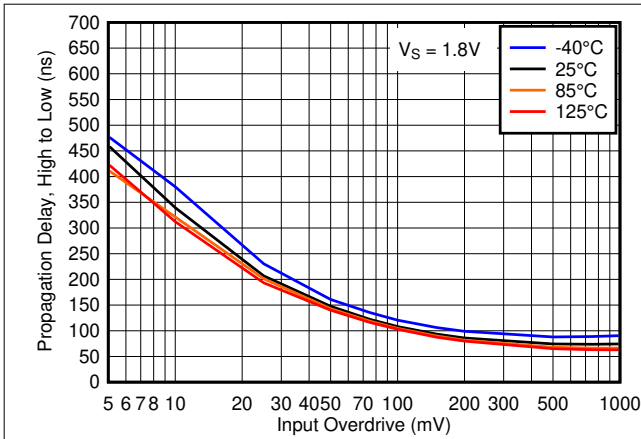

Figure 6-17. Propagation Delay, High to Low, 1.8V

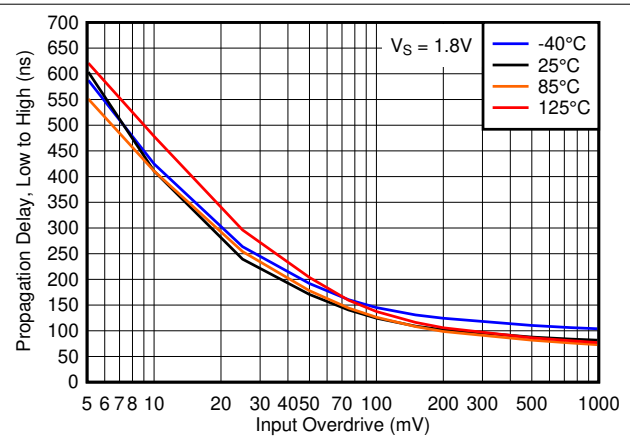

Figure 6-18. Propagation Delay, Low to High, 1.8V

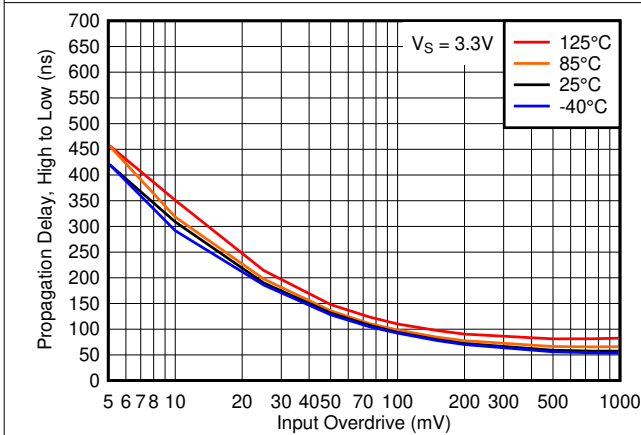

Figure 6-19. Propagation Delay, High to Low, 3.3V

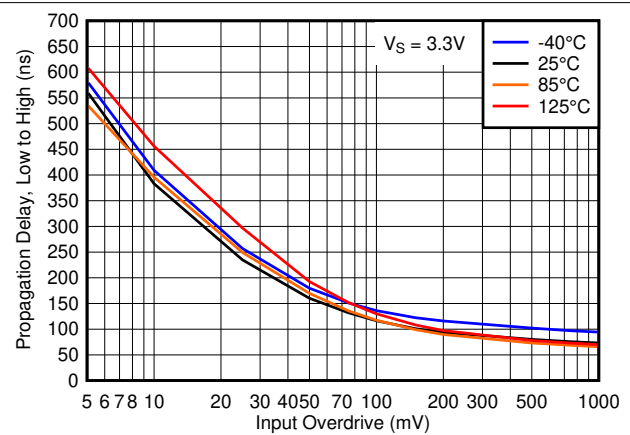

Figure 6-20. Propagation Delay, Low to High, 3.3V

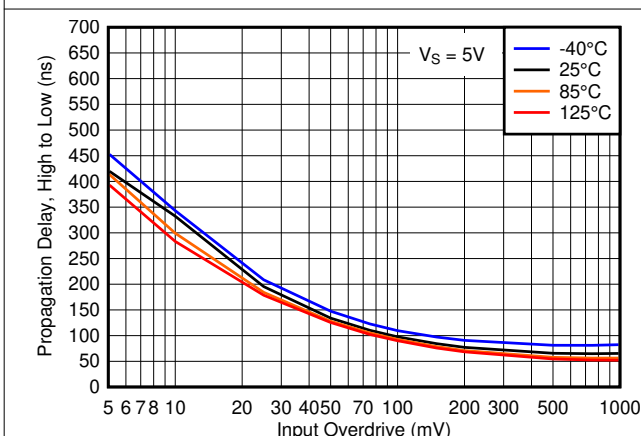

Figure 6-21. Propagation Delay, High to Low, 5V

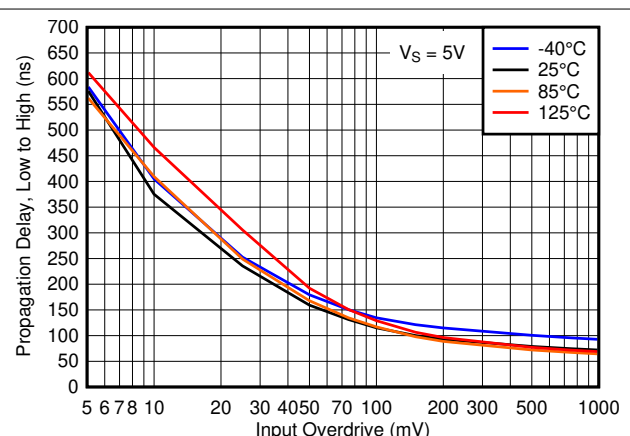

Figure 6-22. Propagation Delay, Low to High, 5V

6 Typical Characteristics (continued)

$T_A = 25^\circ\text{C}$, $V_S = 5\text{V}$, $R_{\text{PULLUP}} = 2.5\text{k}$, $C_L = 15\text{pF}$, $V_{\text{CM}} = 0\text{V}$, $V_{\text{UNDERDRIVE}} = 100\text{mV}$, $V_{\text{OVERDRIVE}} = 100\text{mV}$ unless otherwise noted.

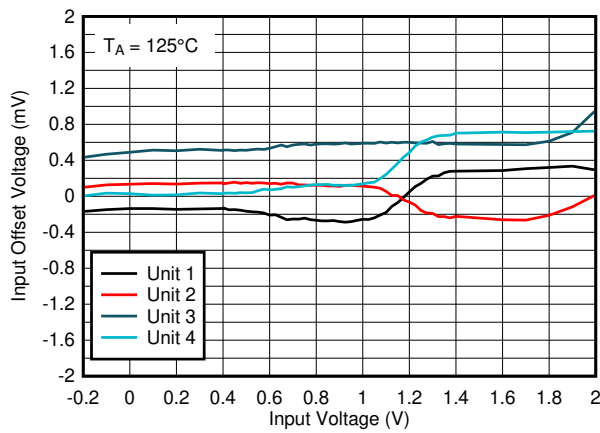

Figure 6-23. Offset Voltage vs. Input Voltage at 125°C, 1.8V

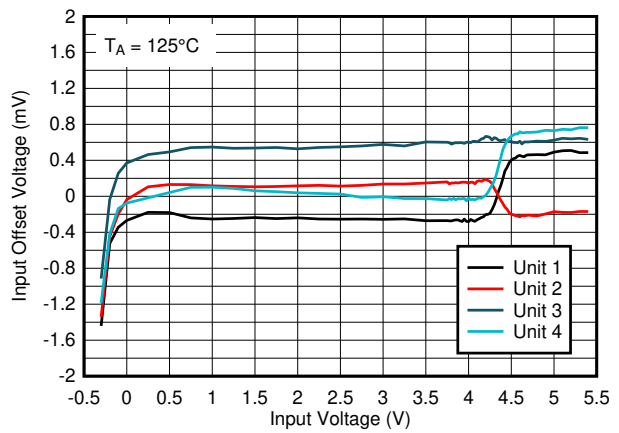

Figure 6-24. Offset Voltage vs. Input Voltage at 125°C, 5V

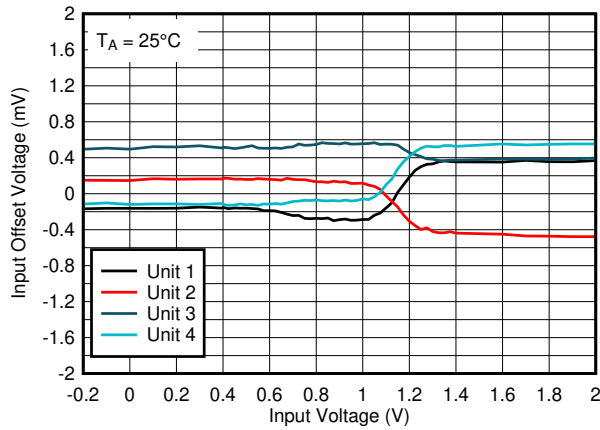

Figure 6-25. Offset Voltage vs. Input Voltage at 25°C, 1.8V

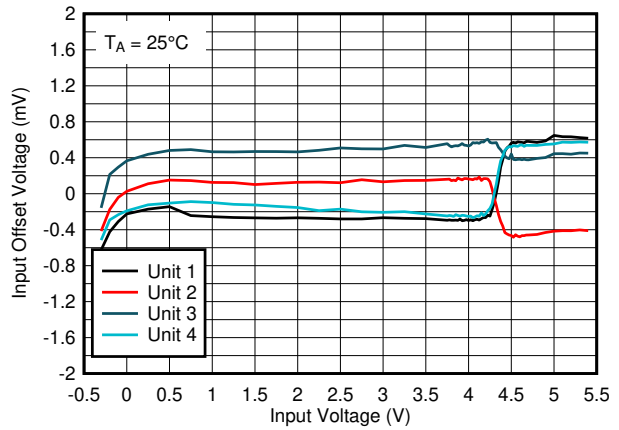

Figure 6-26. Offset Voltage vs. Input Voltage at 25°C, 5V

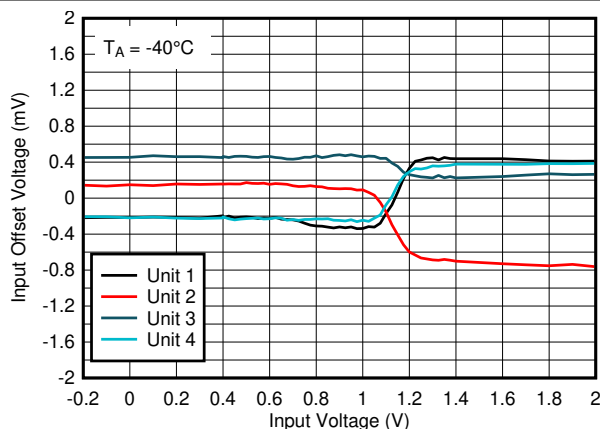

Figure 6-27. Offset Voltage vs. Input Voltage at -40°C, 1.8V

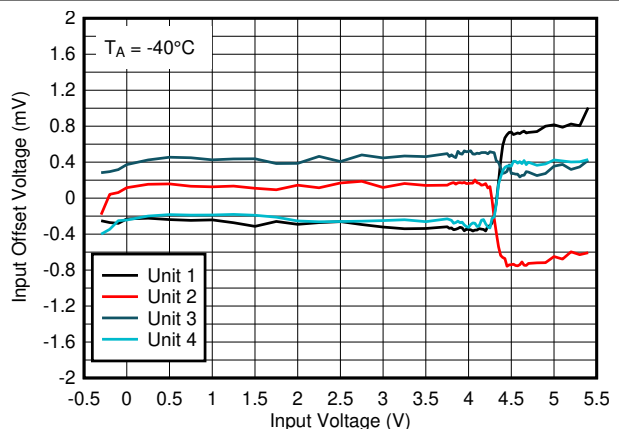

Figure 6-28. Offset Voltage vs. Input Voltage at -40°C, 5V

6 Typical Characteristics (continued)

$T_A = 25^\circ\text{C}$, $V_S = 5\text{V}$, $R_{\text{PULLUP}} = 2.5\text{k}$, $C_L = 15\text{pF}$, $V_{\text{CM}} = 0\text{V}$, $V_{\text{UNDERDRIVE}} = 100\text{mV}$, $V_{\text{OVERDRIVE}} = 100\text{mV}$ unless otherwise noted.

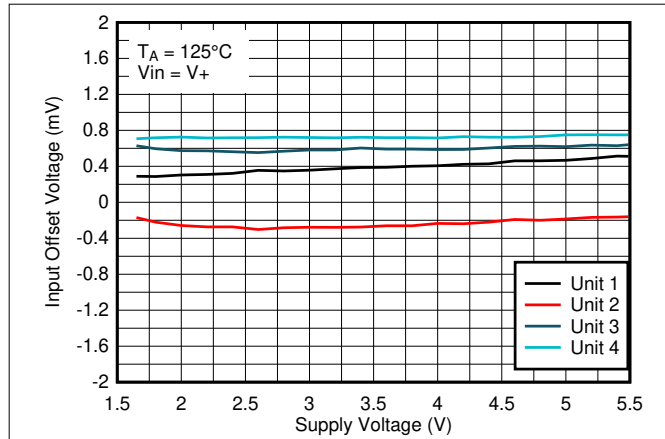

Figure 6-29. Offset Voltage vs. Supply Voltage at 125°C , $V_{\text{IN}}=V_+$

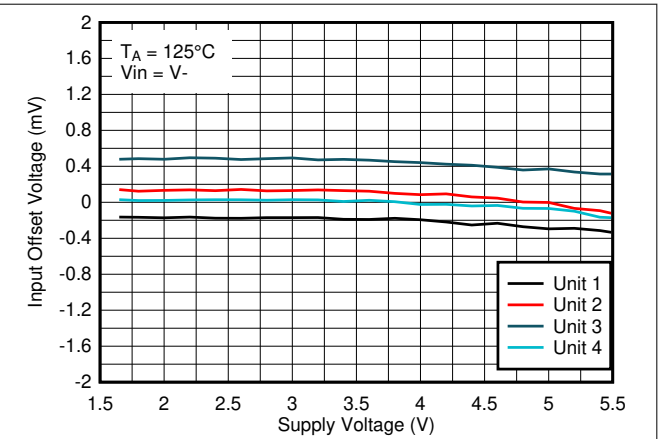

Figure 6-30. Offset Voltage vs. Supply Voltage at 125°C , $V_{\text{IN}}=V_-$

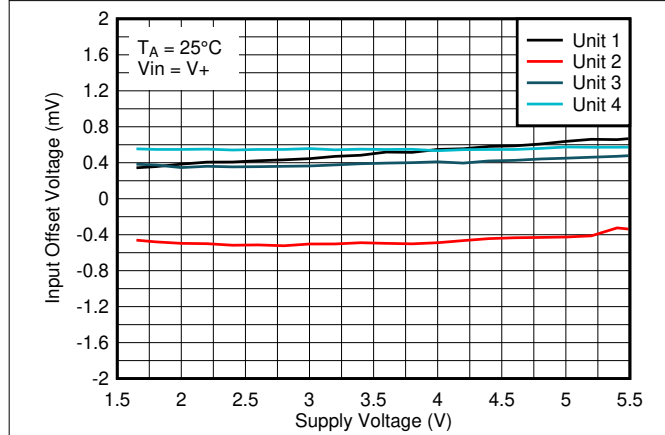

Figure 6-31. Offset Voltage vs. Supply Voltage at 25°C , $V_{\text{IN}}=V_+$

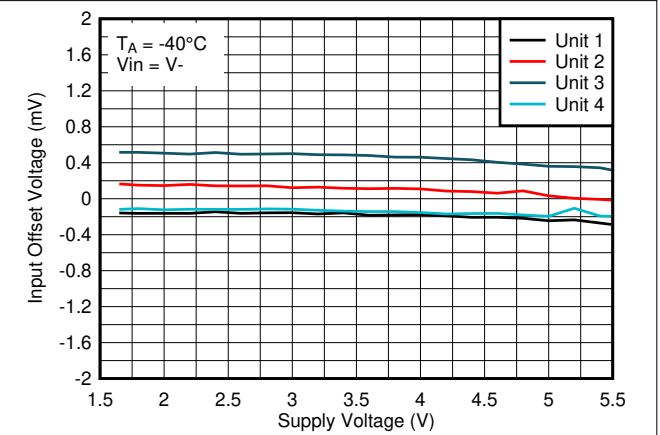

Figure 6-32. Offset Voltage vs. Supply Voltage at 25°C , $V_{\text{IN}}=V_-$

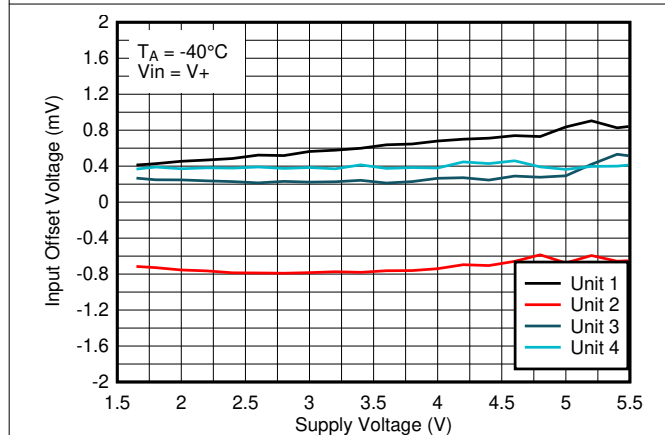

Figure 6-33. Offset Voltage vs. Supply Voltage at -40°C , $V_{\text{IN}}=V_+$

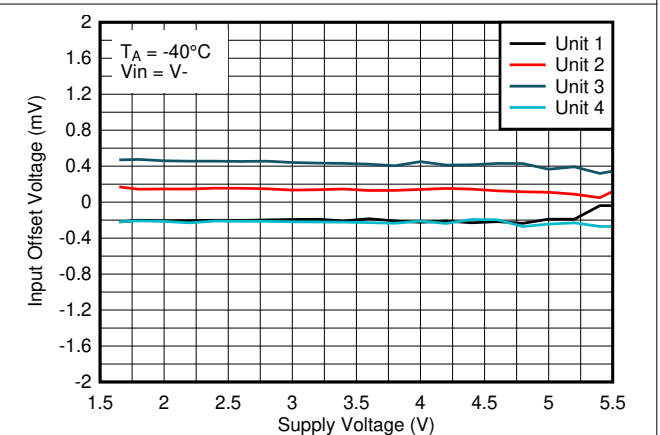

Figure 6-34. Offset Voltage vs. Supply Voltage at -40°C , $V_{\text{IN}}=V_-$

7 Detailed Description

7.1 Overview

The TLV9024-EP and TLV9034-EP devices are quad channel Enhanced Product, micro-power comparators with push-pull and open-drain outputs and low input offset voltage. Operating down to 1.65V while only consuming only 25µA per channel.

7.2 Functional Block Diagram

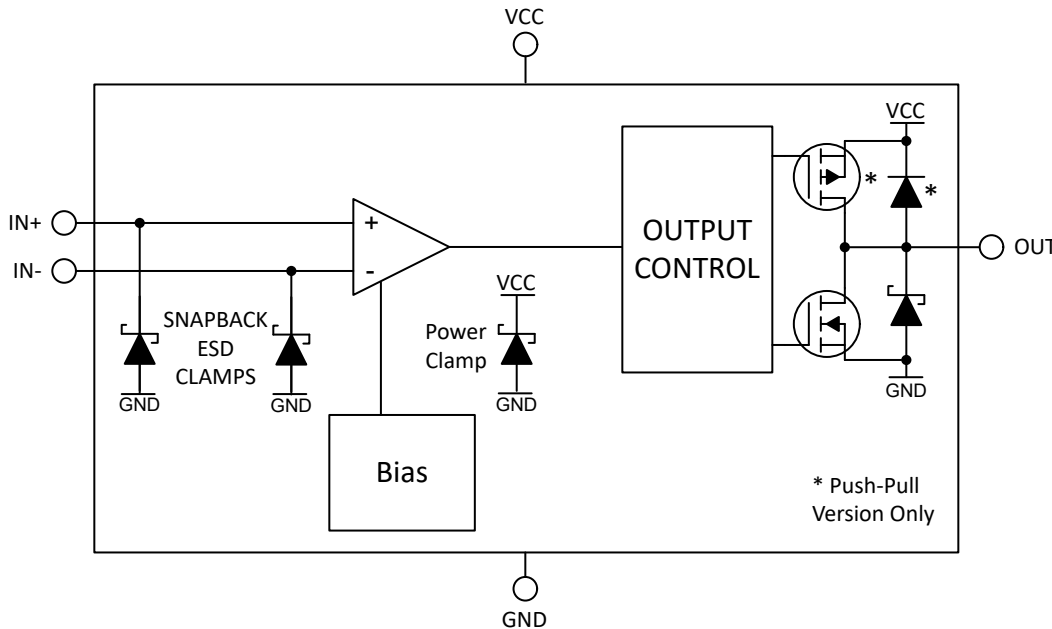

7.3 Feature Description

The TLV9024-EP (open-drain output) and TLV9034-EP (push-pull output) devices are micro-power comparators that have low input offset voltages and are capable of operating at low voltages. The TLV9024-EP and TLV9034-EP family feature a rail-to-rail input stage capable of operating up to 200mV beyond the power supply rails. The comparators also feature push-pull and open-drain output stage options.

7.4 Device Functional Modes

7.4.1 Outputs

7.4.1.1 TLV9024-EP Open Drain Output

The TLV9024-EP features an open-drain (also commonly called open collector) sinking-only output stage enabling the output logic levels to be pulled up to an external voltage from 0V up to 5.5V, independent of the comparator supply voltage (V_S). The open-drain output also allows logical OR'ing of multiple open drain outputs and logic level translation. TI recommends setting the pull-up resistor current to between 100µA and 1mA. Lower pull-up resistor values help increase the risetime, but at the expense of increasing V_{OL} and higher power dissipation. The risetime is dependant on the time constant of the total pull-up resistance and total load capacitance. Large value pull-up resistors (>1MΩ) create an exponential rising edge due to the RC time constant and increase the risetime.

Unused open drain outputs must be left floating, or can be tied to the V- pin if floating pins are not allowed. While an individual output can typically sink up to 125mA, the total combined current for all channels must be less than 200mA.

7.4.1.2 TLV9034-EP Push-Pull Output

The TLV9034-EP features a push-pull output stage capable of both sinking and sourcing current. This allows driving loads such as LED's and MOSFET gates, as well as eliminating the need for a power-wasting external pull-up resistor. The push-pull output must never be connected to another output.

Unused push-pull outputs must be left floating, and never tied to a supply, ground, or another output. While an individual output can typically sink and source up to 100mA, the total combined current for all channels must be less than 200mA.

7.4.2 Inputs

7.4.2.1 Rail to Rail Input

The TLV9024-EP and TLV9034-EP input voltage range extends from 200mV below V_- to 200mV above V_+ . The differential input voltage (V_{ID}) can be any voltage within these limits. No phase-inversion of the comparator output occurs when the input pins exceed V_+ or V_- .

7.4.2.2 Fault Tolerant Inputs

The TLV9024-EP and TLV9034-EP inputs are fault tolerant up to 5.5V independent of V_S . Fault tolerant is defined as maintaining the same high input impedance when V_S is unpowered or within the recommended operating ranges.

The fault tolerant inputs can be any value between 0V and 5.5V, even while V_S is zero or ramping up or down. This feature avoids power sequencing issues as long as the input voltage range and supply voltage are within the specified ranges. This is possible since the inputs are not clamped to V_+ and the input current maintains the current value even when a higher voltage is applied to the inputs.

As long as one of the input pins remains within the valid input range, and the supply voltage is valid, the output state is correct.

The following is a summary of input voltage excursions and the outcomes:

1. When both IN_- and IN_+ are within the specified input voltage range:
 - a. If IN_- is higher than IN_+ and the offset voltage, the output is low.
 - b. If IN_- is lower than IN_+ and the offset voltage, the output is high.
2. When IN_- is outside the specified input voltage range and IN_+ is within the specified voltage range, the output is low.
3. When IN_+ is higher than the specified input voltage range and IN_- is within the specified input voltage range, the output is high
4. When IN_- and IN_+ are both outside the specified input voltage range, the output is **indeterminate** (random).
Do not operate in this region.

Even with the fault tolerant feature, TI *strongly* recommends keeping the inputs within the specified input voltage range during normal system operation to maintain data sheet specifications. Operating outside the specified input range can cause changes in specifications such as propagation delay and input bias current, which can lead to unpredictable behavior.

7.4.2.3 Input Protection

The input bias current is typically 5pA for input voltages between V_+ and V_- . The comparator inputs are protected from reverse voltage by the internal ESD diodes connected to V_- . As the input voltage goes under V_- , or above the input Absolute Maximum ratings the protection diodes become forward biased and begin to conduct causing the input bias current to increase exponentially. Input bias current typically doubles for each 10°C temperature increase.

If the inputs are to be connected to a low impedance source, such as a power supply or buffered reference line, TI recommends adding a current-limiting resistor in series with the input to limit any transient currents in the event the clamps conduct. The current must be limited 10mA or less. This series resistance can be part of any resistive input dividers or networks.

7.4.3 ESD Protection

The TLV9024-EP and TLV9034-EP family incorporates internal ESD protection circuits on all pins. The inputs, and the open-drain output, use a proprietary "snapback" type ESD clamp from each pin to V-, which allows the pins to exceed the supply voltage (V+). While shown as Zener diodes, snapback "short" and go low impedance (like an SCR) when the threshold is exceeded, as opposed to clamping to a defined voltage like a Zener.

The TLV9024-EP open-drain output protection also consists of a ESD clamp between the output and V- to allow the output to be pulled above V+ to a maximum of 5.5V.

The TLV9034-EP push-pull output protection consists of a ESD clamp between the output and V-, but also includes a ESD diode clamp to V+, as the output must not exceed the supply rails.

If the inputs are to be connected to a low impedance source, such as a power supply or buffered reference line, TI recommends adding a current-limiting resistor in series with the input to limit any transient currents must the clamps conduct. The current must be limited 10mA or less. This series resistance can be part of any resistive input dividers or networks. TI does not specify the performance of the ESD clamps and external clamping must be added if the inputs or output exceed the maximum ratings as part of normal operation.

7.4.4 Unused Inputs

If a channel is not to be used, DO NOT tie the inputs together. Due to the high equivalent bandwidth and low offset voltage, tying the inputs directly together can cause high frequency "chatter" as the device triggers on it's own internal wideband noise. Instead, the inputs must be tied to any available voltage that resides within the specified input voltage range and provides a minimum of 50mV differential voltage. For example, one input can be grounded and the other input connected to a reference voltage, or even V+ as long as the input is directly connected to the V+ pin (to avoid transients).

7.4.5 Hysteresis

The TLV9024-EP and TLV9034-EP family does not have internal hysteresis. Due to the wide effective bandwidth and low input offset voltage, there is a possibility that the output can "chatter" when the absolute differential voltage near zero as the comparator triggers on it's own internal wideband noise. This is normal comparator behavior and is expected. TI recommends that the user add external hysteresis if slow moving signals are expected. See [Hysteresis](#) in the following section.

8 Application and Implementation

Note

Information in the following applications sections is not part of the TI component specification, and TI does not warrant its accuracy or completeness. TI's customers are responsible for determining suitability of components for their purposes. Customers should validate and test their design implementation to confirm system functionality.

8.1 Application Information

8.1.1 Basic Comparator Definitions

8.1.1.1 Operation

The basic comparator compares the input voltage (V_{IN}) on one input to a reference voltage (V_{REF}) on the other input. In the [Comparator Timing Diagram](#) example below, if V_{IN} is less than V_{REF} , the output voltage (V_O) is logic low (V_{OL}). If V_{IN} is greater than V_{REF} , the output voltage (V_O) is at logic high (V_{OH}). [Output Conditions](#) summarizes the output conditions. The output logic can be inverted by simply swapping the input pins.

Table 8-1. Output Conditions

Inputs Condition	Output
$IN+ > IN-$	HIGH (V_{OH})
$IN+ = IN-$	Indeterminate (chatters - see Hysteresis)
$IN+ < IN-$	LOW (V_{OL})

8.1.1.2 Propagation Delay

There is a delay between from when the input crosses the reference voltage and the output responds. This is called the Propagation Delay. Propagation delay can be different between high-to low and low-to-high input transitions. This is shown as t_{pLH} and t_{pHL} in [Comparator Timing Diagram](#) and is measured from the mid-point of the input to the midpoint of the output.

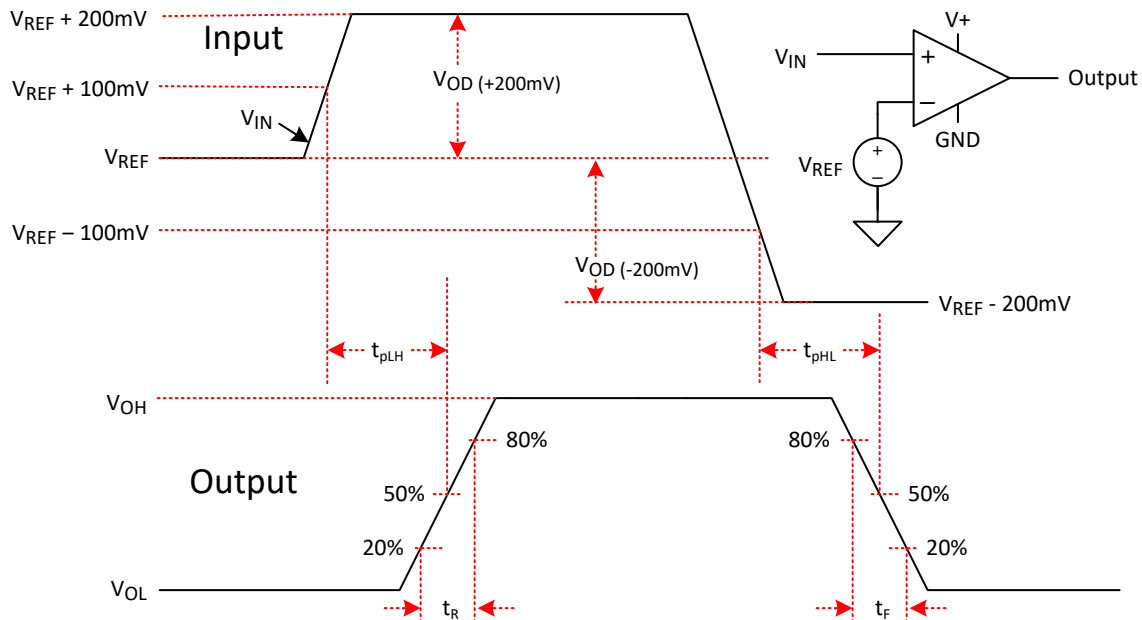

Figure 8-1. Comparator Timing Diagram

8.1.1.3 Overdrive Voltage

The overdrive voltage, V_{OD} , is the amount of input voltage beyond the reference voltage (and not the total input peak-to-peak voltage). The overdrive voltage is 100mV as shown in the [Comparator Timing Diagram](#) example. The overdrive voltage can influence the propagation delay (t_p). The smaller the overdrive voltage, the longer the propagation delay, particularly when $<100\text{mV}$. If the fastest speeds are desired, apply the highest amount of overdrive possible.

The risetime (t_r) and falltime (t_f) is the time from the 20% and 80% points of the output waveform.

8.1.2 Hysteresis

The basic comparator configuration can oscillate or produce a noisy "chatter" output if the applied differential input voltage is near the comparator's offset voltage. This usually occurs when the input signal is moving very slowly across the switching threshold of the comparator.

This problem can be prevented by the addition of hysteresis or positive feedback.

The hysteresis transfer curve is shown in [Hysteresis Transfer Curve](#). This curve is a function of three components: V_{TH} , V_{OS} , and V_{HYST} :

- V_{TH} is the actual set voltage or threshold trip voltage.
- V_{OS} is the internal offset voltage between V_{IN+} and V_{IN-} . This voltage is added to V_{TH} to form the actual trip point at which the comparator must respond to change output states.
- V_{HYST} is the hysteresis (or trip window) that is designed to reduce comparator sensitivity to noise.

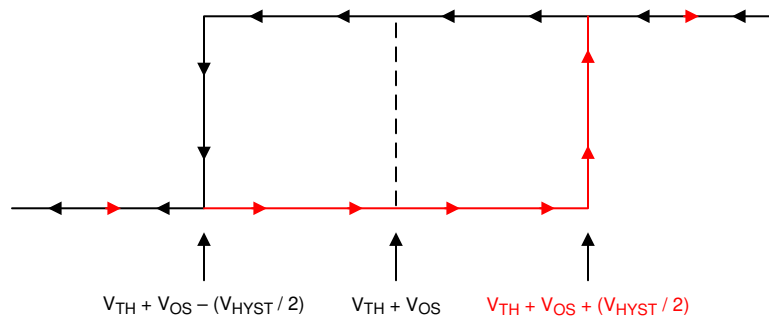

Figure 8-2. Hysteresis Transfer Curve

For more information, please see Application Note SBOA219 "[Comparator with and without hysteresis circuit](#)".

8.1.2.1 Inverting Comparator With Hysteresis

The inverting comparator with hysteresis requires a three-resistor network that is referenced to the comparator supply voltage ($V+$), as shown in [TLV9034-EP in an Inverting Configuration With Hysteresis](#).

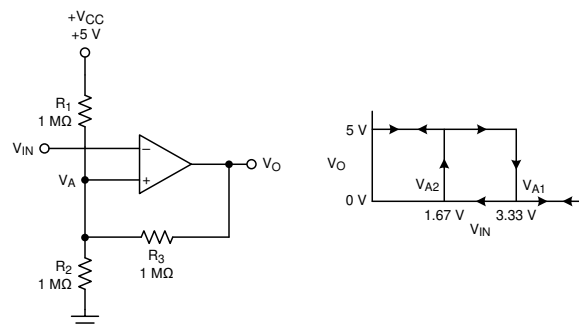

Figure 8-3. TLV9034-EP in an Inverting Configuration With Hysteresis

The equivalent resistor networks when the output is high and low are shown in [Figure 8-3](#).

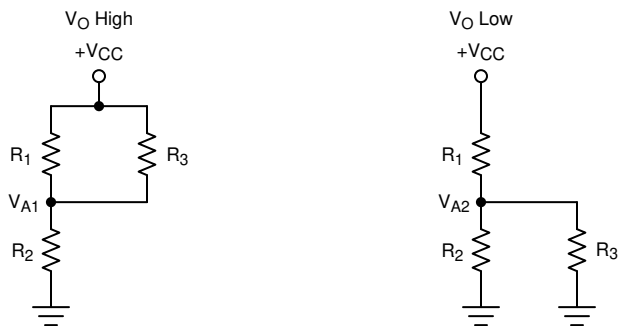

Figure 8-4. Inverting Configuration Resistor Equivalent Networks

When V_{IN} is less than V_A , the output voltage is high (for simplicity, assume V_O switches as high as V_{CC}). The three network resistors can be represented as $R1 \parallel R3$ in series with $R2$, as shown in [Figure 8-4](#).

[Equation 1](#) below defines the high-to-low trip voltage (V_{A1}).

$$V_{A1} = V_{CC} \times \frac{R2}{(R1 \parallel R3) + R2} \quad (1)$$

When V_{IN} is greater than V_A , the output voltage is low. In this case, the three network resistors can be presented as $R2 \parallel R3$ in series with $R1$, as shown in [Equation 2](#).

Use [Equation 2](#) to define the low to high trip voltage (V_{A2}).

$$V_{A2} = V_{CC} \times \frac{R2 \parallel R3}{R1 + (R2 \parallel R3)} \quad (2)$$

[Equation 3](#) defines the total hysteresis provided by the network.

$$\Delta V_A = V_{A1} - V_{A2} \quad (3)$$

8.1.2.2 Non-Inverting Comparator With Hysteresis

A noninverting comparator with hysteresis requires a two-resistor network and a voltage reference (V_{REF}) at the inverting input, as shown in [Figure 8-5](#),

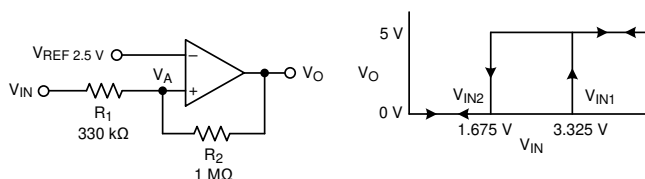

Figure 8-5. TLV9034-EP in a Non-Inverting Configuration With Hysteresis

The equivalent resistor networks when the output is high and low are shown in [Figure 8-6](#).

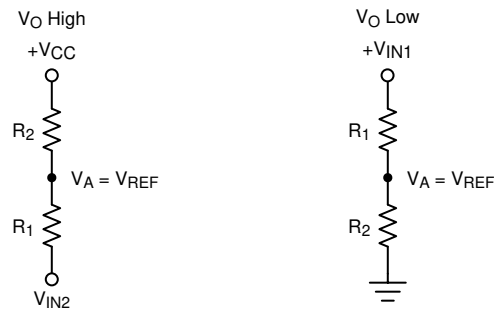

Figure 8-6. Non-Inverting Configuration Resistor Networks

When V_{IN} is less than V_{REF} , the output is low. For the output to switch from low to high, V_{IN} must rise above the V_{IN1} threshold. Use [Equation 4](#) to calculate V_{IN1} .

$$V_{IN1} = R1 \times \frac{V_{REF}}{R2} + V_{REF} \quad (4)$$

When V_{IN} is greater than V_{REF} , the output is high. For the comparator to switch back to a low state, V_{IN} must drop below V_{IN2} . Use [Equation 5](#) to calculate V_{IN2} .

$$V_{IN2} = \frac{V_{REF} (R1 + R2) - V_{CC} \times R1}{R2} \quad (5)$$

The hysteresis of this circuit is the difference between V_{IN1} and V_{IN2} , as shown in [Equation 6](#).

$$\Delta V_{IN} = V_{CC} \times \frac{R1}{R2} \quad (6)$$

For more information, please see Application Notes SNOA997 "[Inverting comparator with hysteresis circuit](#)" and SBOA313 "[Non-Inverting Comparator With Hysteresis Circuit](#)".

8.1.2.3 Inverting and Non-Inverting Hysteresis using Open-Drain Output

An open drain output device can also be used, however the output pull-up resistor must also be taken into account in the calculations. The pull-up resistor is seen in series with the feedback resistor when the output is high. Thus, the feedback resistor is actually seen as $R2 + R_{PULLUP}$. TI recommends that the pull-up resistor be at least 10 times less than the feedback resistor value.

8.2 Typical Applications

8.2.1 Window Comparator

Window comparators are commonly used to detect undervoltage and overvoltage conditions. [Figure 8-7](#) shows a simple window comparator circuit. Window comparators require open drain outputs (TLV9024-EP) if the outputs are directly connected together.

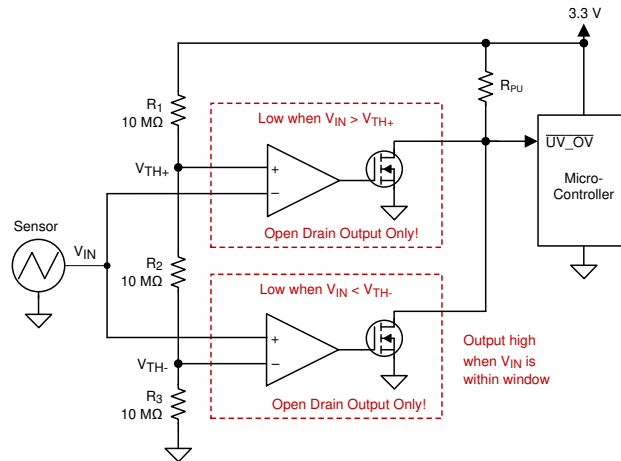

Figure 8-7. Window Comparator

8.2.1.1 Design Requirements

For this design, follow these design requirements:

- Alert (logic low output) when an input signal is less than 1.1V
- Alert (logic low output) when an input signal is greater than 2.2V
- Alert signal is active low
- Operate from a 3.3V power supply

8.2.1.2 Detailed Design Procedure

Configure the circuit as shown in [Figure 8-7](#). Connect V_{CC} to a 3.3V power supply and V_{EE} to ground. Make R1, R2 and R3 each 10MΩ resistors. These three resistors are used to create the positive and negative thresholds for the window comparator (V_{TH+} and V_{TH-}).

With each resistor being equal, V_{TH+} is 2.2V and V_{TH-} is 1.1V. Large resistor values such as 10MΩ are used to minimize power consumption. The resistor values can be recalculated to provide the desired trip point values.

The sensor output voltage is applied to the inverting and noninverting inputs of the two comparators. Using two open-drain output comparators allows the two comparator outputs to be Wire-OR'ed together.

The respective comparator outputs are low when the sensor is less than 1.1V or greater than 2.2V. The respective comparator outputs are high when the sensor is in the range of 1.1V to 2.2V (within the "window"), as shown in [Figure 8-8](#).

8.2.1.3 Application Curve

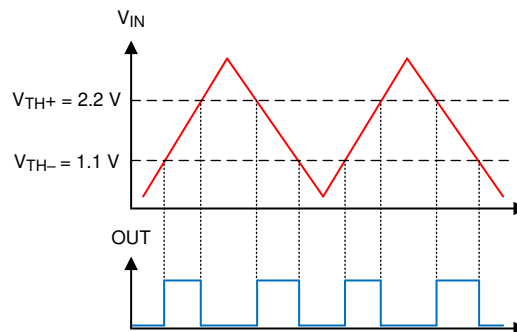

Figure 8-8. Window Comparator Results

For more information, please see Application note SBOA221 "[Window comparator circuit](#)".

8.2.2 Square-Wave Oscillator

Square-wave oscillator can be used as low cost timing reference or system supervisory clock source. A push-pull output (TLV9034-EP) is recommended for best symmetry.

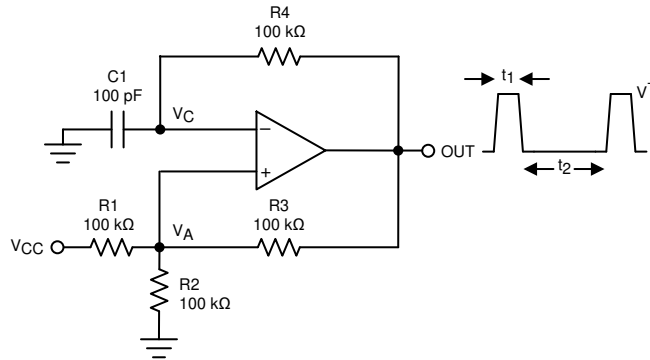

Figure 8-9. Square-Wave Oscillator

8.2.2.1 Design Requirements

The square-wave period is determined by the RC time constant of the capacitor C_1 and resistor R_4 . The maximum frequency is limited by propagation delay of the device and the capacitance load at the output. The low input bias current allows a lower capacitor value and larger resistor value combination for a given oscillator frequency, which can help to reduce BOM cost and board space. R_4 must be over several kilo-ohms to minimize loading the output.

8.2.2.2 Detailed Design Procedure

The oscillation frequency is determined by the resistor and capacitor values. The following calculation provides details of the steps.

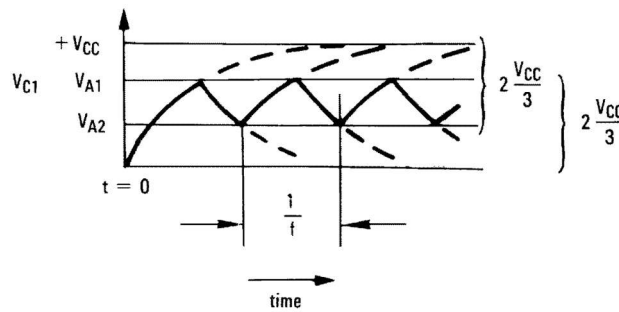

Figure 8-10. Square-Wave Oscillator Timing Thresholds

First consider the output of [Figure 8-9](#) as high, which indicates the inverted input V_C is lower than the noninverting input (V_A). This causes the C_1 to be charged through R_4 , and the voltage V_C increases until equal to the noninverting input. The value of V_A at the point is calculated by [Equation 7](#).

$$V_{A1} = \frac{V_{CC} \times R_2}{R_2 + R_1 \parallel R_3} \quad (7)$$

if $R_1 = R_2 = R_3$, then $V_{A1} = 2V_{CC} / 3$

At this time the comparator output trips pulling down the output to the negative rail. The value of V_A at this point is calculated by [Equation 8](#).

$$V_{A2} = \frac{V_{CC}(R_2 || R_3)}{R_1 + R_2 || R_3} \quad (8)$$

if $R_1 = R_2 = R_3$, then $V_{A2} = V_{CC}/3$

The C_1 now discharges through the R_4 , and the voltage V_{CC} decreases until reaching V_{A2} . At this point, the output switches back to the starting state. The oscillation period equals to the time duration for C_1 from $2V_{CC}/3$ to $V_{CC}/3$ then back to $2V_{CC}/3$, which is given by $R_4 C_1 \times \ln 2$ for each trip. Therefore, the total time duration is calculated as $2 R_4 C_1 \times \ln 2$.

The oscillation frequency can be obtained by [Equation 9](#):

$$f = 1 / (2 R_4 \times C_1 \times \ln 2) \quad (9)$$

8.2.2.3 Application Curve

[Figure 8-11](#) shows the simulated results of an oscillator using the following component values:

- $R_1 = R_2 = R_3 = R_4 = 100\text{k}\Omega$
- $C_1 = 100\text{pF}$, $C_L = 20\text{pF}$
- $V_+ = 5\text{V}$, $V_- = \text{GND}$
- C_{stray} (not shown) from V_A TO GND = 10pF

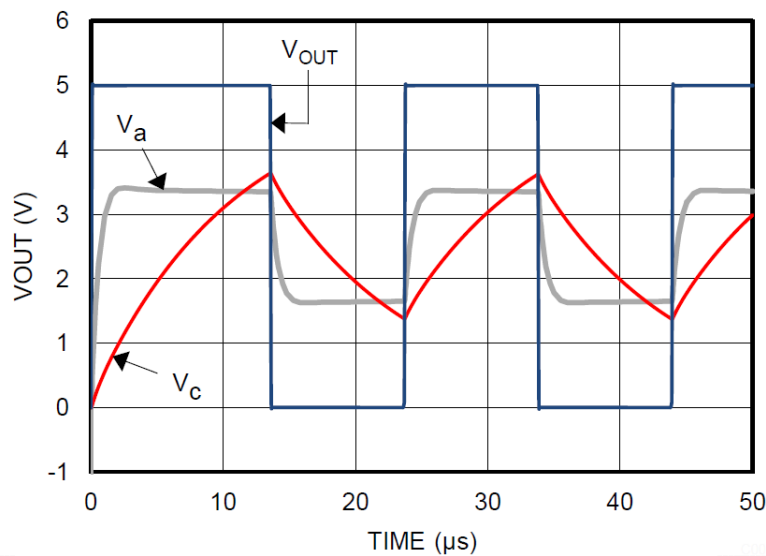

Figure 8-11. Square-Wave Oscillator Output Waveform

8.2.3 Adjustable Pulse Width Generator

[Adjustable Pulse Width Generator](#) is a variation on the [Square-Wave Oscillator](#) that allows adjusting the pulse widths.

R_4 and R_5 provide separate charge and discharge paths for the capacitor C depending on the output state.

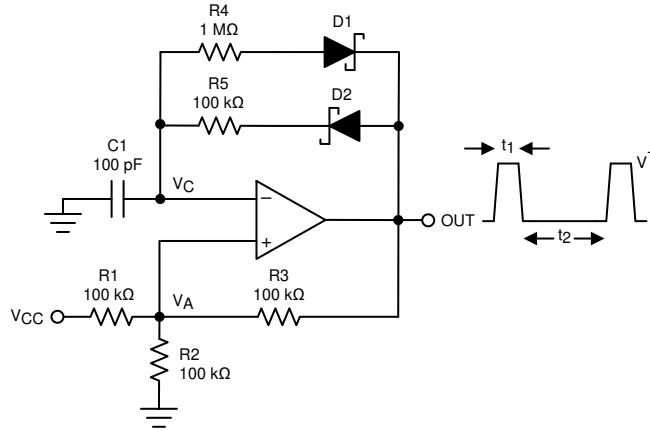

Figure 8-12. Adjustable Pulse Width Generator

The charge path is set through R_5 and D_2 when the output is high. Similarly, the discharge path for the capacitor is set by R_4 and D_1 when the output is low.

The pulse width t_1 is determined by the RC time constant of R_5 and C . Thus, the time t_2 between the pulses can be changed by varying R_4 , and the pulse width can be altered by R_5 . The frequency of the output can be changed by varying both R_4 and R_5 . At low voltages, the effects of the diode forward drop (0.8V, or 0.15V for Shottky) must be taken into account by altering output high and low voltages in the calculations.

8.2.4 Time Delay Generator

The circuit shown in [Figure 8-13](#) provides output signals at a prescribed time interval from a time reference and automatically resets the output low when the input returns to 0V. This is useful for sequencing a "power on" signal to trigger a controlled start-up of power supplies.

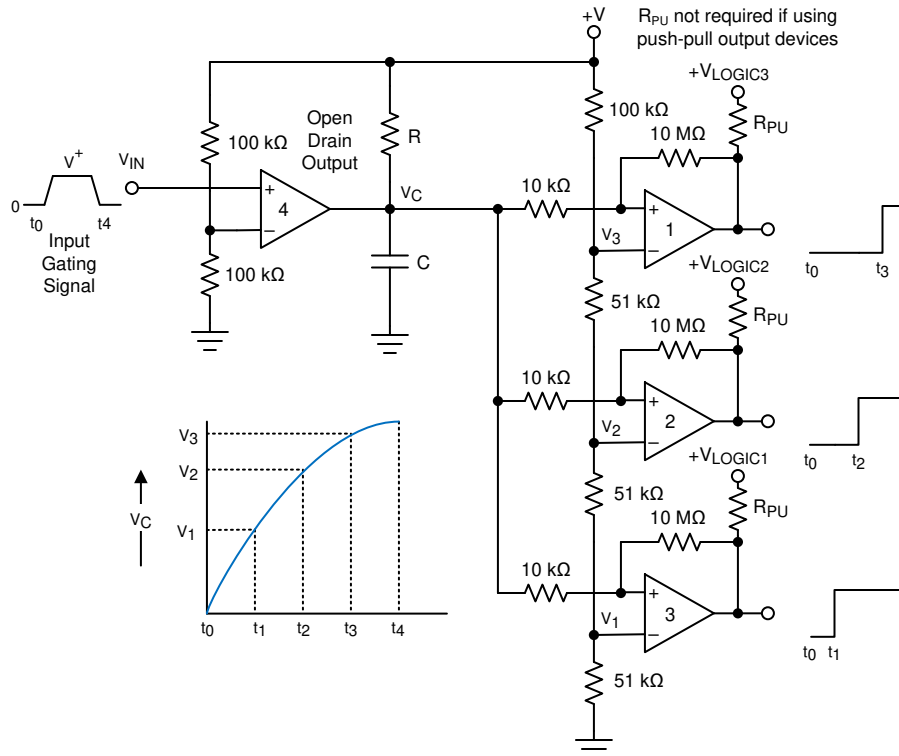

Figure 8-13. Time Delay Generator

Consider the case of $V_{IN} = 0V$. The output of comparator 4 is also at ground, "shorting" the capacitor and holding the capacitor to 0V. This implies that the outputs of comparators 1, 2, and 3 are also at 0V. When an input signal is applied, the output of open drain comparator 4 goes High-Z and C charges exponentially through R. This is indicated in the graph. The output voltages of comparators 1, 2, and 3 switch to the high state in sequence when V_C rises above the reference voltages V_1 , V_2 and V_3 . A small amount of hysteresis has been provided by the 10k Ω and 10M Ω resistors to insure fast switching when the RC time constant is chosen to give long delay times. A good starting point is $R = 100k\Omega$ and $C = 0.01\mu F$ to 1 μF .

All outputs immediately go low when V_{IN} falls to 0V, due to the comparator output going low and immediately discharging the capacitor.

Comparator 4 must be a open-drain type output (TLV9024-EP), whereas comparators 1 though 3 can be either open drain or push-pull output, depending on system requirements. R_{PU} is not required for push-pull output devices.

8.2.5 Logic Level Shifter

The output of the TLV9024-EP is the uncommitted drain of the output transistor. Many open-drain outputs can be tied together to provide an output OR'ing function if desired.

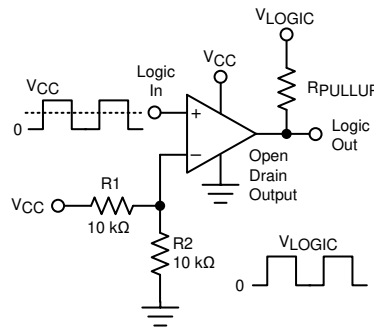

Figure 8-14. Universal Logic Level Shifter

The two 10k Ω resistors bias the input to half of the input logic supply level to set the threshold in the mid-point of the input logic levels. Only one shared output pull-up resistor is needed and can be connected to any pull-up voltage between 0V and 5.5V. The pullup voltage must match the driven logic input "high" level.

8.2.6 One-Shot Multivibrator

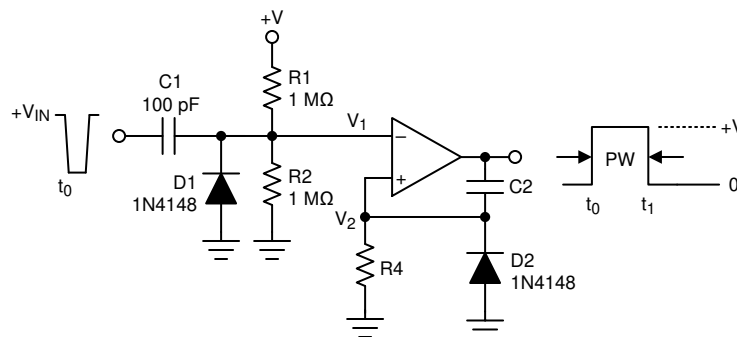

Figure 8-15. One-Shot Multivibrator

A monostable multivibrator has one stable state in which to remain indefinitely. The circuit can be triggered externally to another quasi-stable state. A monostable multivibrator can thus be used to generate a pulse of desired width.

The desired pulse width is set by adjusting the values of C_2 and R_4 . The resistor divider of R_1 and R_2 can be used to determine the magnitude of the input trigger pulse. The output changes state when $V_1 < V_2$. Diode D_2

provides a rapid discharge path for capacitor C_2 to reset at the end of the pulse. The diode also prevents the non-inverting input from being driven below ground.

8.2.7 Bi-Stable Multivibrator

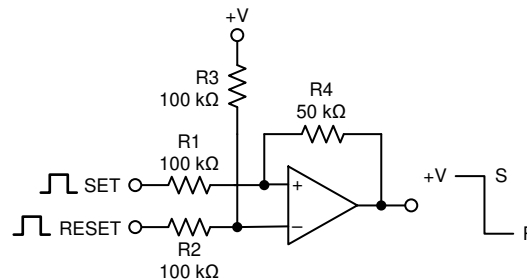

Figure 8-16. Bi-Stable Multivibrator

A bi-stable multivibrator has two stable states. The reference voltage is set up by the voltage divider of R_2 and R_3 . A pulse applied to the SET terminal sets the output of the comparator high. The resistor divider of R_1 , R_4 , and R_5 now clamps the non-inverting input to a voltage greater than the reference voltage. A pulse applied to RESET now toggles the output low.

8.2.8 Zero Crossing Detector

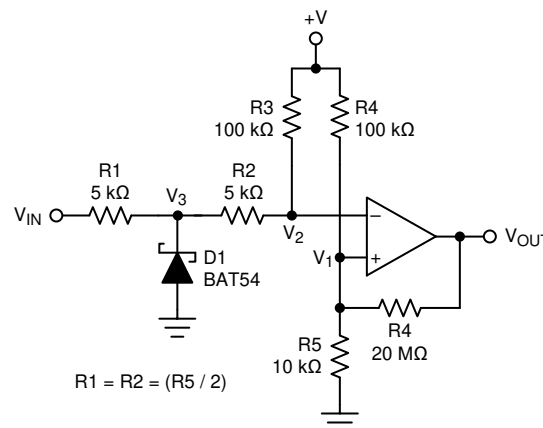

Figure 8-17. Zero Crossing Detector

A voltage divider of R_4 and R_5 establishes a reference voltage V_1 at the non-inverting input. By making the series resistance of R_1 and R_2 equal to R_5 , the comparator switches when $V_{IN} = 0$. Diode D_1 makes sure that V_3 clamps near ground. The voltage divider of R_2 and R_3 then prevents V_2 from going below ground. A small amount of hysteresis is setup to provide rapid output voltage transitions.

8.2.9 Pulse Slicer

A Pulse Slicer is a variation of the Zero Crossing Detector and is used to detect the zero crossings on an input signal with a varying baseline level. This circuit works best with symmetrical waveforms. The RC network of R_1 and C_1 establishes an mean reference voltage V_{REF} , which tracks the mean amplitude of the V_{IN} signal. The noninverting input is directly connected to V_{REF} through R_2 . R_2 and R_3 are used to produce hysteresis to keep transitions free of spurious toggles. The time constant is a tradeoff between long-term symmetry and response time to changes in amplitude.

If the waveform is data, the data can be encoded in NRZ (Non-Return to Zero) format to maintain proper average baseline. Asymmetrical inputs can suffer from timing distortions caused by the changing V_{REF} average voltage.

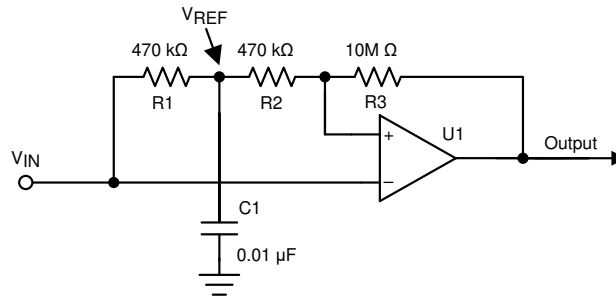

Figure 8-18. Pulse Slicer using TLV9034-EP

For this design, follow these design requirements:

- The RC constant value (R_2 and C_1) must support the targeted data rate to maintain a valid tripping threshold.
- The hysteresis introduced with R_2 and R_{43} helps to avoid spurious output toggles.

The TLV9024-EP can also be used, but with the addition of a pull-up resistor on the output (not shown for clarity).

Figure 8-19 shows the results of a 9600 baud data signal riding on a varying baseline.

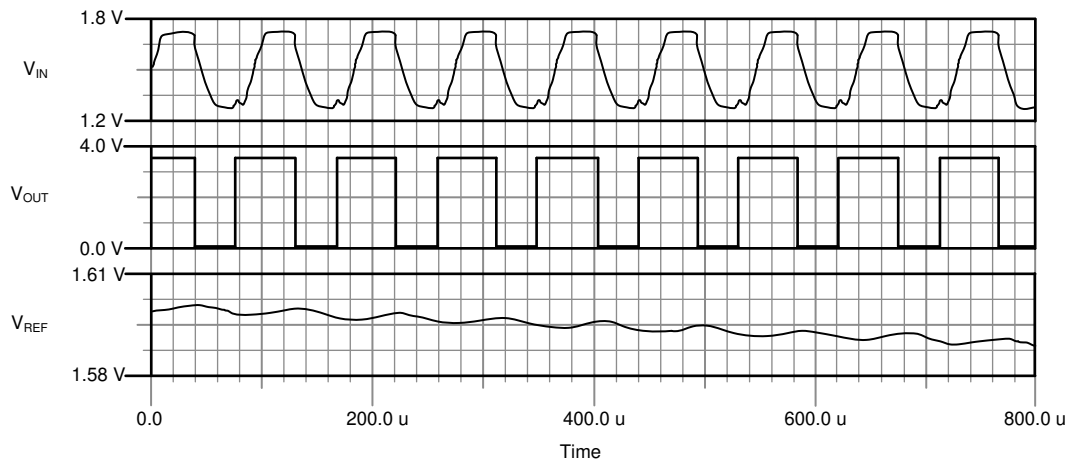

Figure 8-19. Pulse Slicer Waveforms

8.3 Power Supply Recommendations

Due to the fast output edges, bypass capacitors on the supply pin are critical to prevent supply ringing and false triggers and oscillations. Bypass the supply directly at *each* device with a low ESR 0.1μF ceramic bypass capacitor directly between V_{CC} pin and ground pins. Narrow, peak currents are drawn during the output transition time, particularly for the push-pull output device. These narrow pulses can cause un-bypassed supply lines and poor grounds to ring, possibly causing variation that can eat into the input voltage range and create an inaccurate comparison or even oscillations.

The device can be powered from either "split" supplies ($V+$, $V-$ & GND), or a "single" supply ($V+$ and GND), with GND applied to the $V-$ pin.

Input signals must stay within the specified input range (between $V+$ and $V-$) for either type.

Note that on "split" supplies, the output swings "low" (V_{OL}) to $V-$ potential and not GND.

9 Layout

9.1 Layout Guidelines

For accurate comparator applications a stable power supply with minimized noise and glitches is important for proper operation. Output rise and fall times are in the tens of nanoseconds, and must be treated as high speed logic devices. The bypass capacitor must be as close to the supply pin as possible and connected to a solid ground plane, and preferably directly between the V_{CC} and GND pins.

Minimize coupling between outputs and inputs to prevent output oscillations. Do not run output and input traces in parallel unless there is a V_{CC} or GND trace between output to reduce coupling. When series resistance is added to inputs, place resistor close to the device. A low value (<100 ohms) resistor can also be added in series with the output to dampen any ringing or reflections on long, non-impedance controlled traces. For best edge shapes, controlled impedance traces with back-terminations must be used when routing long distances.

9.2 Layout Example

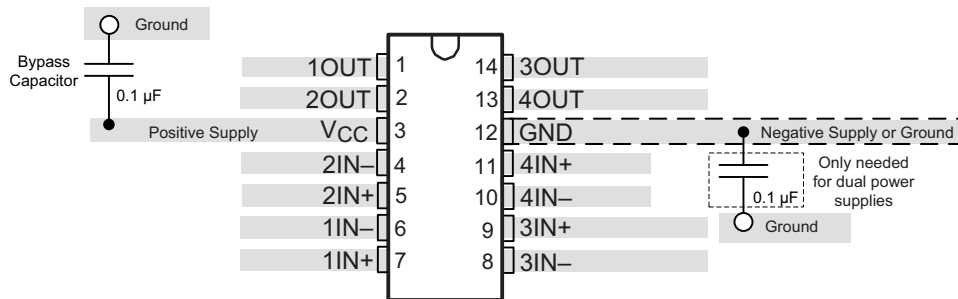

Figure 9-1. Layout Example

10 Device and Documentation Support

10.1 Documentation Support

10.1.1 Related Documentation

[Analog Engineers Circuit Cookbook: Amplifiers \(See Comparators section\) - SLYY137](#)

[Precision Design, Comparator with Hysteresis Reference Design— TIDU020](#)

[Window comparator circuit - SBOA221](#)

[Reference Design, Window Comparator Reference Design— TIPD178](#)

[Comparator with and without hysteresis circuit - SBOA219](#)

[Inverting comparator with hysteresis circuit - SNOA997](#)

[Non-Inverting Comparator With Hysteresis Circuit - SBOA313](#)

[Zero crossing detection using comparator circuit - SNOA999](#)

[PWM generator circuit - SBOA212](#)

[How to Implement Comparators for Improving Performance of Rotary Encoder in Industrial Drive Applications - SNOAA41](#)

[A Quad of Independently Func Comparators - SNOA654](#)

10.2 Receiving Notification of Documentation Updates

To receive notification of documentation updates, navigate to the device product folder on ti.com. Click on *Notifications* to register and receive a weekly digest of any product information that has changed. For change details, review the revision history included in any revised document.

10.3 Support Resources

[TI E2E™ support forums](#) are an engineer's go-to source for fast, verified answers and design help — straight from the experts. Search existing answers or ask your own question to get the quick design help you need.

Linked content is provided "AS IS" by the respective contributors. They do not constitute TI specifications and do not necessarily reflect TI's views; see TI's [Terms of Use](#).

10.4 Trademarks

TI E2E™ is a trademark of Texas Instruments.

All trademarks are the property of their respective owners.

10.5 Electrostatic Discharge Caution



This integrated circuit can be damaged by ESD. Texas Instruments recommends that all integrated circuits be handled with appropriate precautions. Failure to observe proper handling and installation procedures can cause damage.

ESD damage can range from subtle performance degradation to complete device failure. Precision integrated circuits may be more susceptible to damage because very small parametric changes could cause the device not to meet its published specifications.

10.6 Glossary

[TI Glossary](#) This glossary lists and explains terms, acronyms, and definitions.

11 Revision History

NOTE: Page numbers for previous revisions may differ from page numbers in the current version.

DATE	REVISION	NOTES
April 2025	*	Initial Release

12 Mechanical, Packaging, and Orderable Information

The following pages include mechanical, packaging, and orderable information. This information is the most current data available for the designated devices. This data is subject to change without notice and revision of this document. For browser-based versions of this data sheet, refer to the left-hand navigation.

PACKAGING INFORMATION

Orderable part number	Status (1)	Material type (2)	Package Pins	Package qty Carrier	RoHS (3)	Lead finish/ Ball material (4)	MSL rating/ Peak reflow (5)	Op temp (°C)	Part marking (6)
TLV9024MDYYTEP	Active	Production	SOT-23-THIN (DYY) 14	250 SMALL T&R	Yes	NIPDAU	Level-2-260C-1 YEAR	-	TLV9024EP
TLV9034MDYYTEP	Active	Production	SOT-23-THIN (DYY) 14	250 SMALL T&R	Yes	NIPDAU	Level-2-260C-1 YEAR	-	TLV9034EP
V62/24640-01XE	Active	Production	SOT-23-THIN (DYY) 14	250 SMALL T&R	Yes	NIPDAU	Level-2-260C-1 YEAR	See TLV9024MDYYTEP	TLV9024EP
V62/24640-02XE	Active	Production	SOT-23-THIN (DYY) 14	250 SMALL T&R	Yes	NIPDAU	Level-2-260C-1 YEAR	See TLV9034MDYYTEP	TLV9034EP

(1) **Status:** For more details on status, see our [product life cycle](#).

(2) **Material type:** When designated, preproduction parts are prototypes/experimental devices, and are not yet approved or released for full production. Testing and final process, including without limitation quality assurance, reliability performance testing, and/or process qualification, may not yet be complete, and this item is subject to further changes or possible discontinuation. If available for ordering, purchases will be subject to an additional waiver at checkout, and are intended for early internal evaluation purposes only. These items are sold without warranties of any kind.

(3) **RoHS values:** Yes, No, RoHS Exempt. See the [TI RoHS Statement](#) for additional information and value definition.

(4) **Lead finish/Ball material:** Parts may have multiple material finish options. Finish options are separated by a vertical ruled line. Lead finish/Ball material values may wrap to two lines if the finish value exceeds the maximum column width.

(5) **MSL rating/Peak reflow:** The moisture sensitivity level ratings and peak solder (reflow) temperatures. In the event that a part has multiple moisture sensitivity ratings, only the lowest level per JEDEC standards is shown. Refer to the shipping label for the actual reflow temperature that will be used to mount the part to the printed circuit board.

(6) **Part marking:** There may be an additional marking, which relates to the logo, the lot trace code information, or the environmental category of the part.

Multiple part markings will be inside parentheses. Only one part marking contained in parentheses and separated by a "-" will appear on a part. If a line is indented then it is a continuation of the previous line and the two combined represent the entire part marking for that device.

Important Information and Disclaimer: The information provided on this page represents TI's knowledge and belief as of the date that it is provided. TI bases its knowledge and belief on information provided by third parties, and makes no representation or warranty as to the accuracy of such information. Efforts are underway to better integrate information from third parties. TI has taken and continues to take reasonable steps to provide representative and accurate information but may not have conducted destructive testing or chemical analysis on incoming materials and chemicals. TI and TI suppliers consider certain information to be proprietary, and thus CAS numbers and other limited information may not be available for release.

In no event shall TI's liability arising out of such information exceed the total purchase price of the TI part(s) at issue in this document sold by TI to Customer on an annual basis.

OTHER QUALIFIED VERSIONS OF TLV9024-EP, TLV9034-EP :

- Catalog : [TLV9024](#), [TLV9034](#)
- Automotive : [TLV9024-Q1](#), [TLV9034-Q1](#)

NOTE: Qualified Version Definitions:

- Catalog - TI's standard catalog product
- Automotive - Q100 devices qualified for high-reliability automotive applications targeting zero defects

TAPE AND REEL INFORMATION

QUADRANT ASSIGNMENTS FOR PIN 1 ORIENTATION IN TAPE



*All dimensions are nominal

Device	Package Type	Package Drawing	Pins	SPQ	Reel Diameter (mm)	Reel Width W1 (mm)	A0 (mm)	B0 (mm)	K0 (mm)	P1 (mm)	W (mm)	Pin1 Quadrant
TLV9024MDYYTEP	SOT-23-THIN	DYY	14	250	177.8	12.4	3.56	4.5	1.3	8.0	12.0	Q1
TLV9034MDYYTEP	SOT-23-THIN	DYY	14	250	177.8	12.4	3.56	4.5	1.3	8.0	12.0	Q3

TAPE AND REEL BOX DIMENSIONS

*All dimensions are nominal

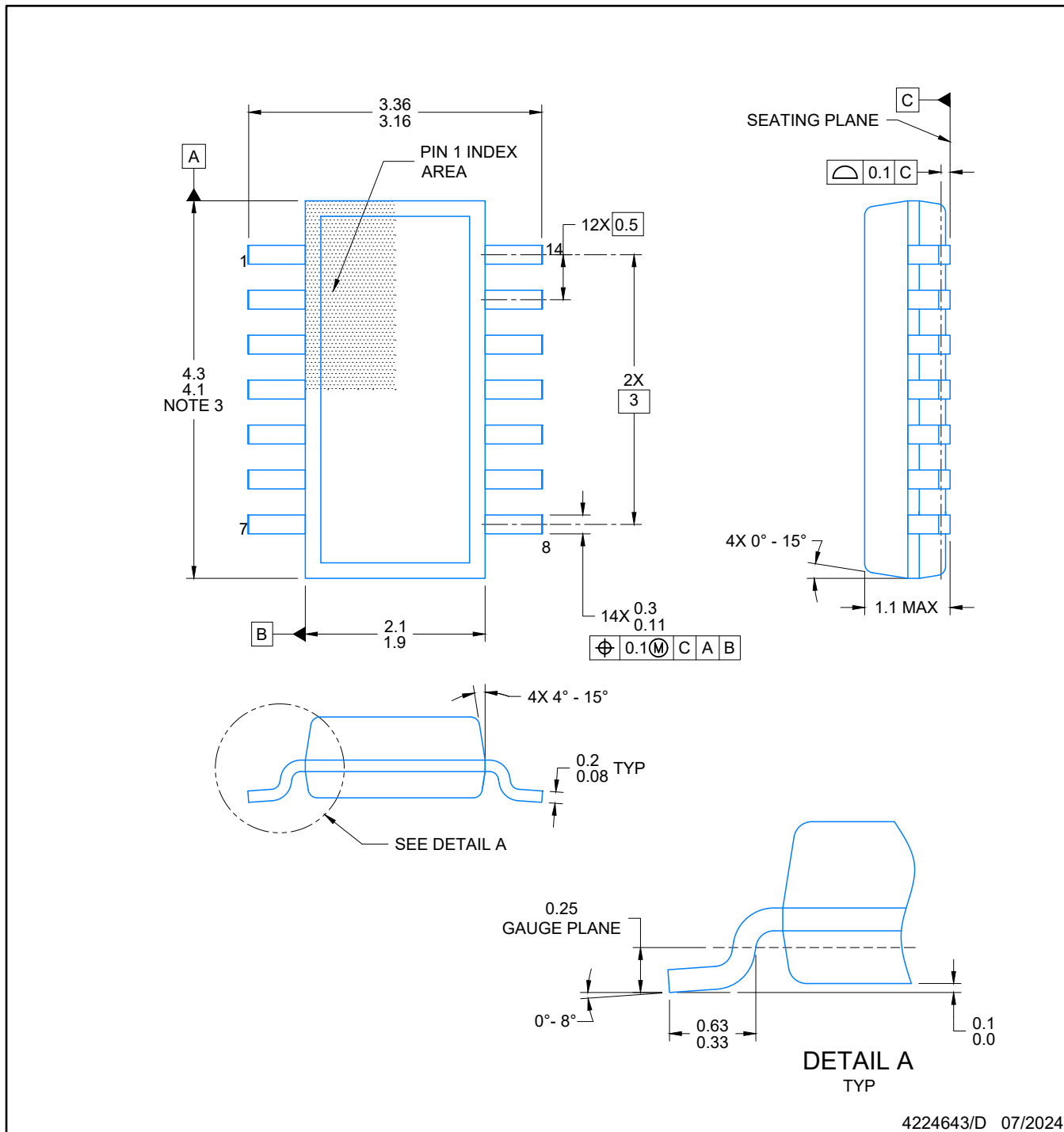
Device	Package Type	Package Drawing	Pins	SPQ	Length (mm)	Width (mm)	Height (mm)
TLV9024MDYYTEP	SOT-23-THIN	DYY	14	250	208.0	191.0	35.0
TLV9034MDYYTEP	SOT-23-THIN	DYY	14	250	208.0	191.0	35.0



4224643/D 07/2024

NOTES:

1. All linear dimensions are in millimeters. Any dimensions in parenthesis are for reference only. Dimensioning and tolerancing per ASME Y14.5M.
2. This drawing is subject to change without notice.
3. This dimension does not include mold flash, protrusions, or gate burrs. Mold flash, protrusions, or gate burrs shall not exceed 0.15 per side.
4. This dimension does not include interlead flash. Interlead flash shall not exceed 0.50 per side.
5. Reference JEDEC Registration MO-345, Variation AB

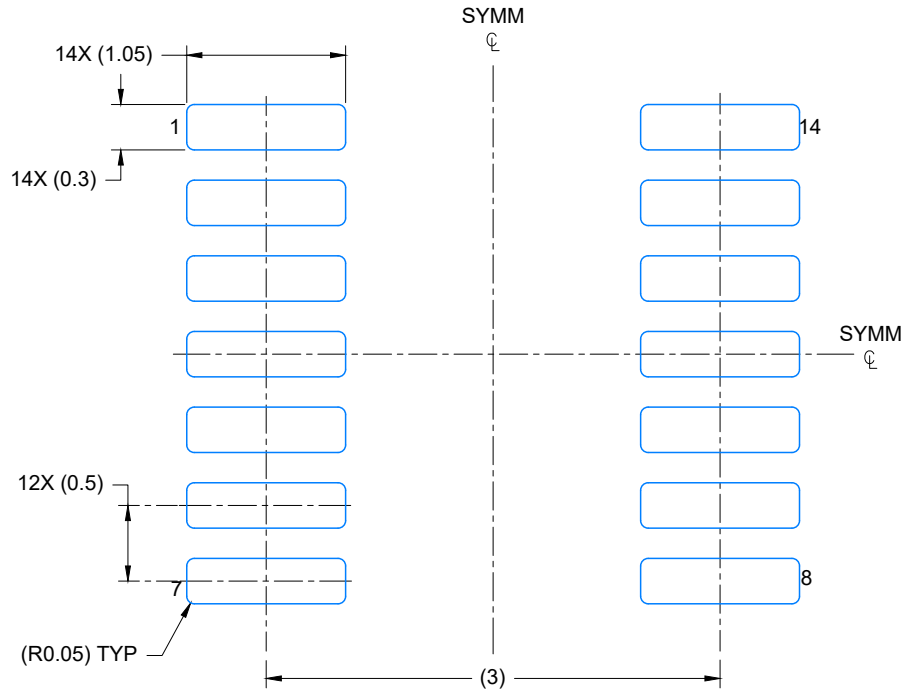

LAND PATTERN EXAMPLE
EXPOSED METAL SHOWN
SCALE: 20X

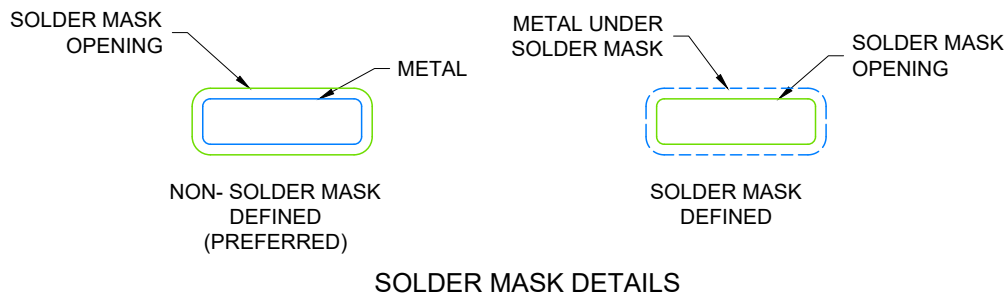

4224643/D 07/2024

NOTES: (continued)

- 6. Publication IPC-7351 may have alternate designs.
- 7. Solder mask tolerances between and around signal pads can vary based on board fabrication site.

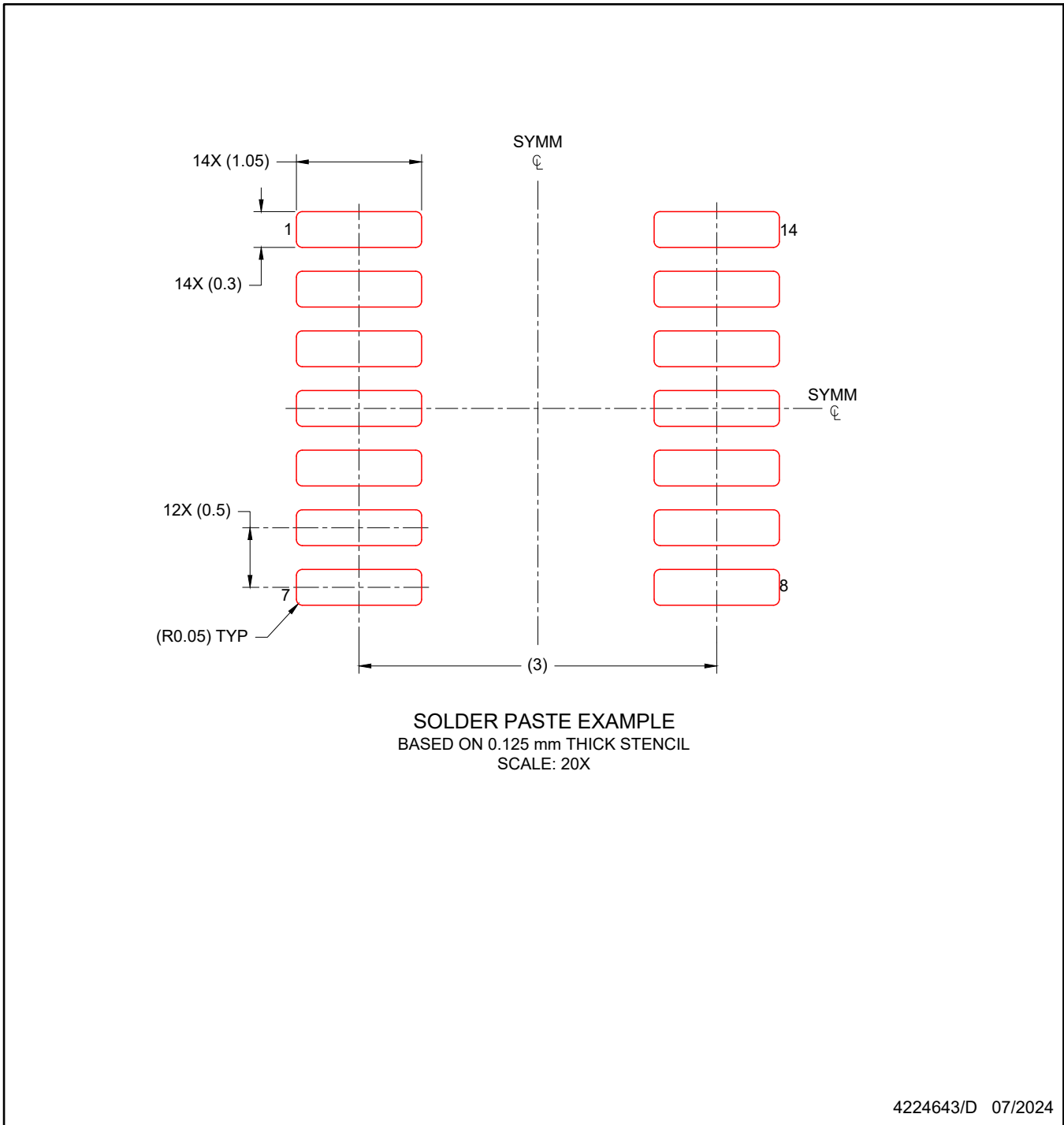

NOTES: (continued)

8. Laser cutting apertures with trapezoidal walls and rounded corners may offer better paste release. IPC-7525 may have alternate design recommendations.
9. Board assembly site may have different recommendations for stencil design.

IMPORTANT NOTICE AND DISCLAIMER

TI PROVIDES TECHNICAL AND RELIABILITY DATA (INCLUDING DATASHEETS), DESIGN RESOURCES (INCLUDING REFERENCE DESIGNS), APPLICATION OR OTHER DESIGN ADVICE, WEB TOOLS, SAFETY INFORMATION, AND OTHER RESOURCES "AS IS" AND WITH ALL FAULTS, AND DISCLAIMS ALL WARRANTIES, EXPRESS AND IMPLIED, INCLUDING WITHOUT LIMITATION ANY IMPLIED WARRANTIES OF MERCHANTABILITY, FITNESS FOR A PARTICULAR PURPOSE OR NON-INFRINGEMENT OF THIRD PARTY INTELLECTUAL PROPERTY RIGHTS.

These resources are intended for skilled developers designing with TI products. You are solely responsible for (1) selecting the appropriate TI products for your application, (2) designing, validating and testing your application, and (3) ensuring your application meets applicable standards, and any other safety, security, regulatory or other requirements.

These resources are subject to change without notice. TI grants you permission to use these resources only for development of an application that uses the TI products described in the resource. Other reproduction and display of these resources is prohibited. No license is granted to any other TI intellectual property right or to any third party intellectual property right. TI disclaims responsibility for, and you fully indemnify TI and its representatives against any claims, damages, costs, losses, and liabilities arising out of your use of these resources.

TI's products are provided subject to [TI's Terms of Sale](#), [TI's General Quality Guidelines](#), or other applicable terms available either on ti.com or provided in conjunction with such TI products. TI's provision of these resources does not expand or otherwise alter TI's applicable warranties or warranty disclaimers for TI products. Unless TI explicitly designates a product as custom or customer-specified, TI products are standard, catalog, general purpose devices.

TI objects to and rejects any additional or different terms you may propose.

Copyright © 2025, Texas Instruments Incorporated

Last updated 10/2025