

TLV930x-Q1 40V, 1MHz, RRO Operational Amplifiers for Cost-Sensitive Systems

1 Features

- Low offset voltage: $\pm 0.5\text{mV}$
- Low offset voltage drift: $\pm 2\mu\text{V}/^\circ\text{C}$
- Low noise: $33\text{nV}/\sqrt{\text{Hz}}$ at 1kHz
- High common-mode rejection: 110dB
- Low bias current: $\pm 10\text{pA}$
- Rail-to-rail output
- Wide bandwidth: 1MHz GBW
- High slew rate: $3\text{V}/\mu\text{s}$
- Low quiescent current: $150\mu\text{A}$ per amplifier
- Wide supply: $\pm 2.25\text{V}$ to $\pm 20\text{V}$, 4.5V to 40V
- Robust EMI performance: 72dB at 1GHz
- MUX-friendly/comparator inputs:
 - Differential and common-mode input voltage range to supply rail
- Industry-standard packages:
 - Single in SOT-23-5 and SC70
 - Dual in SOIC-8, TSSOP-8, and VSSOP-8
 - Quad in SOIC-14 and TSSOP-14

2 Applications

- [Merchant network and server PSU](#)
- [Industrial AC-DC](#)
- [Merchant DC/DC](#)
- [Motor drives: AC and servo drive power supplies](#)
- [Building automation](#)

3 Description

The TLV930x-Q1 family (TLV9301-Q1, TLV9302-Q1, and TLV9304-Q1) is a family of 40V, cost-optimized operational amplifiers. These devices offer strong general-purpose DC and AC specifications, including rail-to-rail output, low offset ($\pm 0.5\text{mV}$, typical), low offset drift ($\pm 2\mu\text{V}/^\circ\text{C}$, typical), and 1MHz bandwidth.

Convenient features such as wide differential input-voltage range, high output current ($\pm 60\text{mA}$), and high slew rate ($3\text{V}/\mu\text{s}$) make the TLV930x-Q1 a robust operational amplifier for high-voltage, cost-sensitive applications.

The TLV930x-Q1 family of op amps is available in standard packages and is specified from -40°C to 125°C .

Device Information

PART NUMBER ⁽¹⁾	CHANNEL COUNT	PACKAGE	PACKAGE SIZE ⁽²⁾
TLV9301-Q1 ⁽⁴⁾	Single	DBV (SOT-23, 5) ⁽³⁾	2.9mm × 2.8mm
		DCK (SC70, 5) ⁽³⁾	2mm × 2.1mm
TLV9302-Q1 ⁽⁴⁾	Dual	D (SOIC, 8) ⁽³⁾	4.9mm × 6mm
		PW (TSSOP, 8) ⁽³⁾	3mm × 6.4mm
TLV9304-Q1	Quad	D (SOIC, 14) ⁽³⁾	8.65mm × 6mm
		PW (TSSOP, 14)	5mm × 6.4mm

- (1) For all available packages, see the orderable addendum at the end of the data sheet.
- (2) The package size (length × width) is a nominal value and includes pins, where applicable.
- (3) This package is preview only.
- (4) This device is preview only.

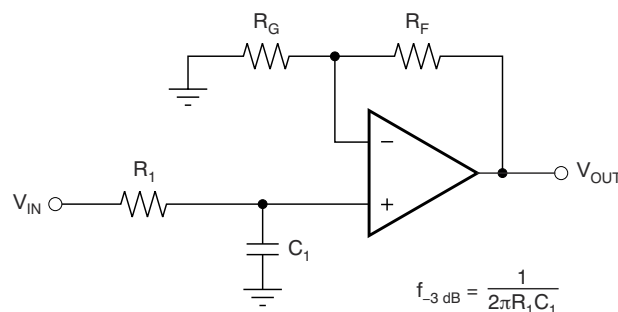

$$\frac{V_{\text{OUT}}}{V_{\text{IN}}} = \left(1 + \frac{R_F}{R_G}\right) \left(\frac{1}{1 + sR_1 C_1}\right)$$

TLV930x-Q1 in a Single-Pole, Low-Pass Filter



Table of Contents

1 Features	1	7 Application and Implementation	25
2 Applications	1	7.1 Application Information.....	25
3 Description	1	7.2 Typical Applications.....	25
4 Pin Configuration and Functions	3	7.3 Power Supply Recommendations.....	26
5 Specifications	6	7.4 Layout.....	26
5.1 Absolute Maximum Ratings.....	6	8 Device and Documentation Support	29
5.2 ESD Ratings.....	6	8.1 Device Support.....	29
5.3 Recommended Operating Conditions.....	6	8.2 Documentation Support.....	29
5.4 Thermal Information for Quad Channel.....	6	8.3 Receiving Notification of Documentation Updates....	29
5.5 Electrical Characteristics.....	7	8.4 Support Resources.....	29
5.6 Typical Characteristics.....	9	8.5 Trademarks.....	29
6 Detailed Description	16	8.6 Electrostatic Discharge Caution.....	29
6.1 Overview.....	16	8.7 Glossary.....	29
6.2 Functional Block Diagram.....	16	9 Revision History	30
6.3 Feature Description.....	17	10 Mechanical, Packaging, and Orderable Information	30
6.4 Device Functional Modes.....	24		

4 Pin Configuration and Functions

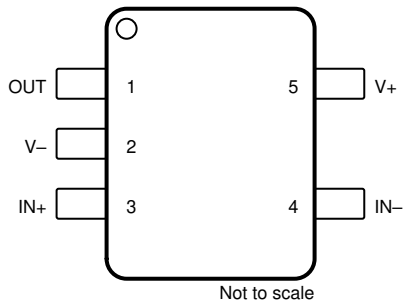

**Figure 4-1. TLV9301-Q1 DBV Package
5-Pin SOT-23⁽¹⁾
Top View**

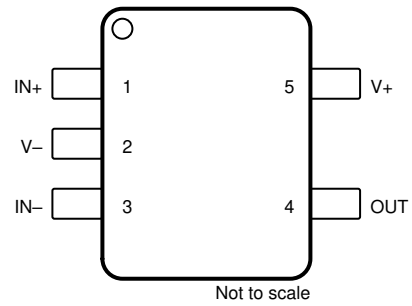

**Figure 4-2. TLV9301-Q1 DCK Package
5-Pin SC70⁽²⁾
Top View**

Table 4-1. Pin Functions: TLV9301-Q1

NAME	PIN		I/O	DESCRIPTION
	DBV	DCK		
+IN	3	1	I	Noninverting input
-IN	4	3	I	Inverting input
OUT	1	4	O	Output
V+	5	5	—	Positive (highest) power supply
V-	2	2	—	Negative (lowest) power supply

(1) DBV (SOT-23) package is preview only.

(2) DCK (SC70) package is preview only.

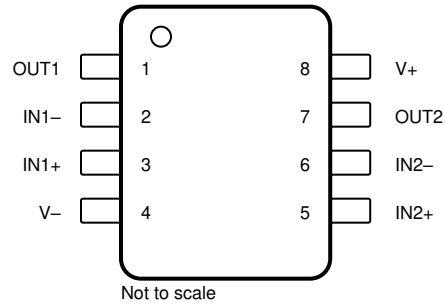

**Figure 4-3. TLV9302-Q1 D and PW Package
8-Pin SOIC and TSSOP⁽¹⁾
Top View**

Table 4-2. Pin Functions: TLV9302-Q1

PIN		I/O	DESCRIPTION
NAME	NO.		
+IN A	3	I	Noninverting input, channel A
+IN B	5	I	Noninverting input, channel B
-IN A	2	I	Inverting input, channel A
-IN B	6	I	Inverting input, channel B
OUT A	1	O	Output, channel A
OUT B	7	O	Output, channel B
V+	8	—	Positive (highest) power supply
V-	4	—	Negative (lowest) power supply

(1) D (SOIC) and PW (TSSOP) packages are preview only.



**Figure 4-4. TLV9304-Q1 D and PW Package
14-Pin SOIC⁽¹⁾ and TSSOP
Top View**

Table 4-3. Pin Functions: TLV9304-Q1

PIN		I/O	DESCRIPTION
NAME	NO.		
+IN A	3	I	Noninverting input, channel A
+IN B	5	I	Noninverting input, channel B
+IN C	10	I	Noninverting input, channel C
+IN D	12	I	Noninverting input, channel D
-IN A	2	I	Inverting input, channel A
-IN B	6	I	Inverting input, channel B
-IN C	9	I	Inverting input, channel C
-IN D	13	I	Inverting input, channel D
OUT A	1	O	Output, channel A
OUT B	7	O	Output, channel B
OUT C	8	O	Output, channel C
OUT D	14	O	Output, channel D
V+	4	—	Positive (highest) power supply
V-	11	—	Negative (lowest) power supply

(1) D (SOIC) package is preview only.

5 Specifications

5.1 Absolute Maximum Ratings

over operating ambient temperature range (unless otherwise noted)⁽¹⁾

		MIN	MAX	UNIT
Supply voltage, $V_S = (V+) - (V-)$		0	42	V
Signal input pins	Common-mode voltage ⁽³⁾	$(V-) - 0.5$	$(V+) + 0.5$	V
	Differential voltage ⁽³⁾		$V_S + 0.2$	V
	Current ⁽³⁾	-10	10	mA
Output short-circuit ⁽²⁾		Continuous		
Operating ambient temperature, T_A		-55	150	°C
Junction temperature, T_J			150	°C
Storage temperature, T_{stg}		-65	150	°C

- (1) Operation outside the Absolute Maximum Ratings may cause permanent device damage. Absolute Maximum Ratings do not imply functional operation of the device at these or any other conditions beyond those listed under Recommended Operating Conditions. If used outside the Recommended Operating Conditions but within the Absolute Maximum Ratings, the device may not be fully functional, and this may affect device reliability, functionality, performance, and shorten the device lifetime.
- (2) Short-circuit to ground, one amplifier per package.
- (3) Input pins are diode-clamped to the power-supply rails. Input signals that may swing more than 0.5V beyond the supply rails must be current limited to 10mA or less.

5.2 ESD Ratings

			VALUE	UNIT
$V_{(ESD)}$	Electrostatic discharge	Human-body model (HBM), per ANSI/ESDA/JEDEC JS-001 ⁽¹⁾	±2000	V
		Charged-device model (CDM), per ANSI/ESDA/JEDEC specification JS-002 ⁽²⁾	±1000	

- (1) JEDEC document JEP155 states that 500V HBM allows safe manufacturing with a standard ESD control process.
- (2) JEDEC document JEP157 states that 250V CDM allows safe manufacturing with a standard ESD control process.

5.3 Recommended Operating Conditions

over operating ambient temperature range (unless otherwise noted)

		MIN	MAX	UNIT
V_S	Supply voltage, $(V+) - (V-)$	4.5	40	V
V_I	Input voltage range	$(V-) - 0.1$	$(V+) - 2$	V
T_A	Specified temperature	-40	125	°C

5.4 Thermal Information for Quad Channel

THERMAL METRIC ⁽¹⁾		TLV9304-Q1		UNIT
		D (SOIC) ⁽²⁾	PW (TSSOP)	
		14 PINS	14 PINS	
$R_{\theta JA}$	Junction-to-ambient thermal resistance	105.5	134.5	°C/W
$R_{\theta JC(top)}$	Junction-to-case (top) thermal resistance	61.4	55.4	°C/W
$R_{\theta JB}$	Junction-to-board thermal resistance	61.0	79.2	°C/W
Ψ_{JT}	Junction-to-top characterization parameter	21.6	9.3	°C/W
Ψ_{JB}	Junction-to-board characterization parameter	60.3	78.4	°C/W
$R_{\theta JC(bot)}$	Junction-to-case (bottom) thermal resistance	N/A	N/A	°C/W

- (1) For more information about traditional and new thermal metrics, see the [Semiconductor and IC Package Thermal Metrics](#) application note.
- (2) This package option is preview for TLV9304-Q1.

5.5 Electrical Characteristics

For $V_S = (V+) - (V-) = 4.5V$ to $40V$ ($\pm 2.25V$ to $\pm 20V$) at $T_A = 25^\circ C$, $R_L = 10k\Omega$ connected to $V_S / 2$, $V_{CM} = V_S / 2$, and $V_{OUT} = V_S / 2$, unless otherwise noted.

PARAMETER		TEST CONDITIONS		MIN	TYP	MAX	UNIT
OFFSET VOLTAGE							
V_{OS}	Input offset voltage	$V_{CM} = V-$			± 0.5	± 2.5	mV
			$T_A = -40^\circ C$ to $125^\circ C$			± 2.75	
dV_{OS}/dT	Input offset voltage drift		$T_A = -40^\circ C$ to $125^\circ C$		± 2		$\mu V/^\circ C$
PSRR	Input offset voltage versus power supply	$V_{CM} = V-$	$T_A = -40^\circ C$ to $125^\circ C$		± 2	± 5	$\mu V/V$
	Channel separation	$f = 0Hz$			5		$\mu V/V$
INPUT BIAS CURRENT							
I_B	Input bias current				± 10		pA
I_{OS}	Input offset current				± 10		pA
NOISE							
E_N	Input voltage noise	$f = 0.1Hz$ to $10Hz$			6		μV_{PP}
					1		μV_{RMS}
e_N	Input voltage noise density	$f = 1kHz$			33		nV/\sqrt{Hz}
		$f = 10kHz$			30		
i_N	Input current noise	$f = 1kHz$			5		fA/\sqrt{Hz}
INPUT VOLTAGE RANGE							
V_{CM}	Common-mode voltage range			$(V-) - 0.2$		$(V+) - 2$	V
CMRR	Common-mode rejection ratio	$V_S = 40V, (V-) - 0.1V < V_{CM} < (V+) - 2V$	$T_A = -40^\circ C$ to $125^\circ C$		95	110	dB
		$V_S = 4.5V, (V-) - 0.1V < V_{CM} < (V+) - 2V$			90		
		$(V+) - 2V < V_{CM} < (V+) + 0.1V$			See Common-Mode Voltage Range		
INPUT CAPACITANCE							
Z_{ID}	Differential				$110 \parallel 4$		$M\Omega \parallel pF$
Z_{ICM}	Common-mode				$6 \parallel 1.5$		$T\Omega \parallel pF$
OPEN-LOOP GAIN							
A_{OL}	Open-loop voltage gain	$V_S = 40V, V_{CM} = V- (V-) + 0.1V < V_O < (V+) - 0.1V$			120	130	dB
			$T_A = -40^\circ C$ to $125^\circ C$		116	127	
FREQUENCY RESPONSE							
GBW	Gain-bandwidth product				1		MHz
SR	Slew rate	$V_S = 40V, G = +1, C_L = 20pF$			3		$V/\mu s$
t_s	Settling time	T_o 0.1%, $V_S = 40V, V_{STEP} = 10V, G = +1, C_L = 20pF$			5		μs
		T_o 0.1%, $V_S = 40V, V_{STEP} = 2V, G = +1, C_L = 20pF$			2.5		
		T_o 0.01%, $V_S = 40V, V_{STEP} = 10V, G = +1, C_L = 20pF$			6		
		T_o 0.01%, $V_S = 40V, V_{STEP} = 2V, G = +1, C_L = 20pF$			3.5		
	Phase margin	$G = +1, R_L = 10k\Omega, C_L = 20pF$			60		$^\circ$
	Overload recovery time	$V_{IN} \times gain > V_S$			1		μs
THD+N	Total harmonic distortion + noise	$V_S = 40V, V_O = 1V_{RMS}, G = -1, f = 1kHz$			0.003%		

TLV9304-Q1

SBOSAJ4 – JUNE 2024

For $V_S = (V+) - (V-) = 4.5V$ to $40V$ ($\pm 2.25V$ to $\pm 20V$) at $T_A = 25^\circ C$, $R_L = 10k\Omega$ connected to $V_S / 2$, $V_{CM} = V_S / 2$, and $V_{OUT} = V_S / 2$, unless otherwise noted.

PARAMETER		TEST CONDITIONS		MIN	TYP	MAX	UNIT
OUTPUT							
	Voltage output swing from rail	Positive and negative rail headroom	$V_S = 40V, R_L = \text{no load}$	3			mV
			$V_S = 40V, R_L = 10k\Omega$	50	75		
			$V_S = 40V, R_L = 2k\Omega$	250	350		
			$V_S = 4.5V, R_L = \text{no load}$	1			
			$V_S = 4.5V, R_L = 10k\Omega$	20	30		
			$V_S = 4.5V, R_L = 2k\Omega$	40	75		
I_{SC}	Short-circuit current			± 60			mA
C_{LOAD}	Capacitive load drive			See Typical Characteristics			
Z_O	Open-loop output impedance	$f = 1MHz, I_O = 0A$		600			Ω
POWER SUPPLY							
I_Q	Quiescent current per amplifier	$I_O = 0A$		150	175		μA
			$T_A = -40^\circ C$ to $125^\circ C$			175	

5.6 Typical Characteristics

at $T_A = 25^\circ\text{C}$, $V_S = \pm 20\text{V}$, $V_{CM} = V_S / 2$, $R_{LOAD} = 10\text{k}\Omega$ connected to $V_S / 2$, and $C_L = 100\text{pF}$ (unless otherwise noted)

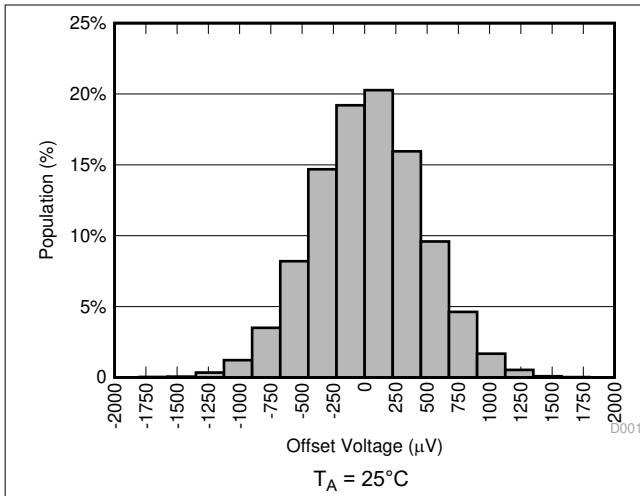

Figure 5-1. Offset Voltage Production Distribution

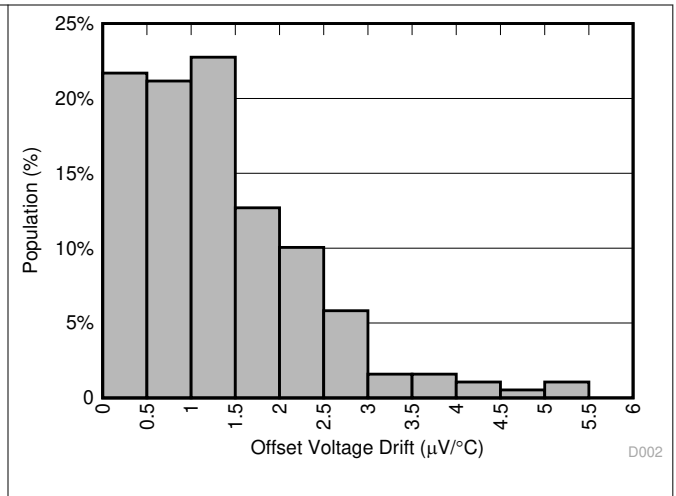

Figure 5-2. Offset Voltage Drift Distribution

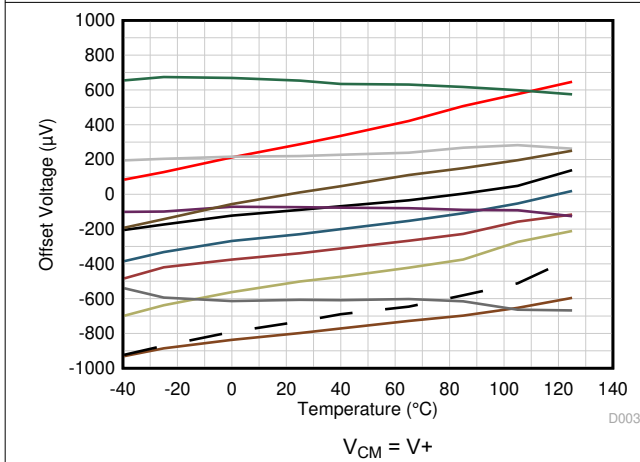

Figure 5-3. Offset Voltage vs Temperature

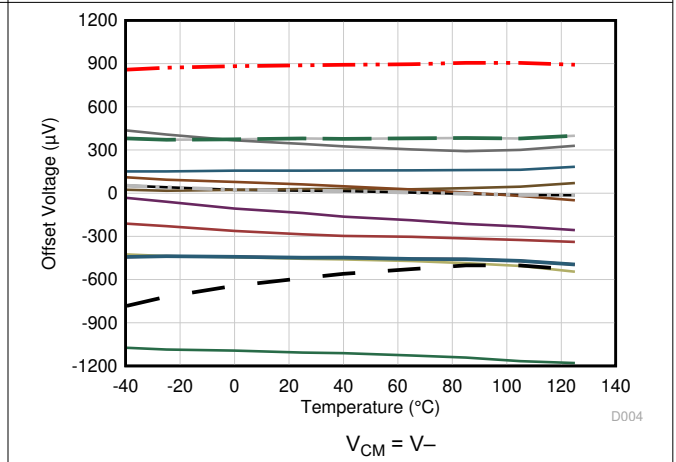

Figure 5-4. Offset Voltage vs Temperature

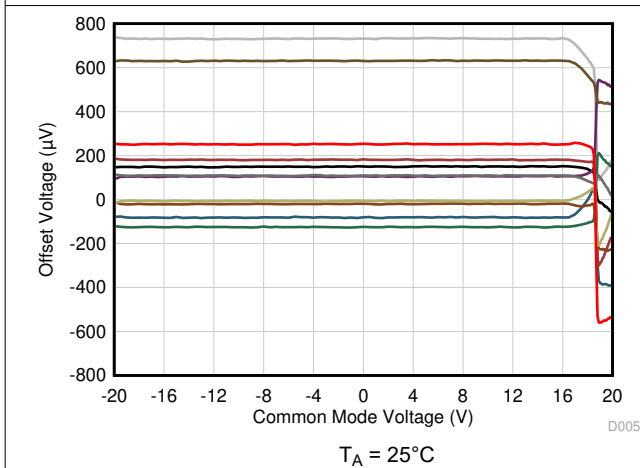

Figure 5-5. Offset Voltage vs Common-Mode Voltage

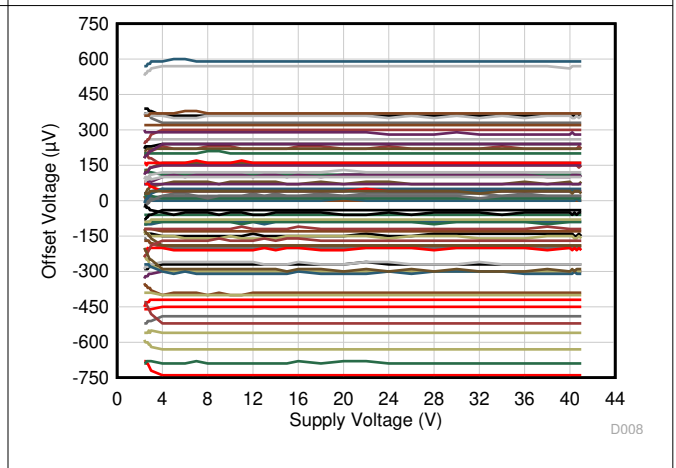

Figure 5-6. Offset Voltage vs Power Supply

5.6 Typical Characteristics (continued)

at $T_A = 25^\circ\text{C}$, $V_S = \pm 20\text{V}$, $V_{CM} = V_S / 2$, $R_{LOAD} = 10\text{k}\Omega$ connected to $V_S / 2$, and $C_L = 100\text{pF}$ (unless otherwise noted)

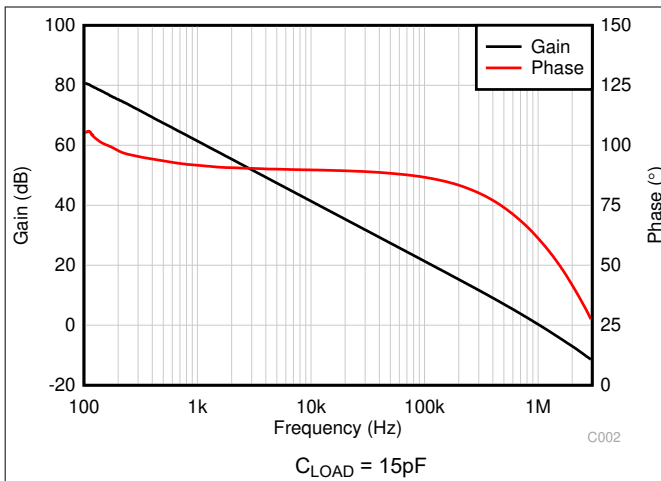

Figure 5-7. Open-Loop Gain and Phase vs Frequency

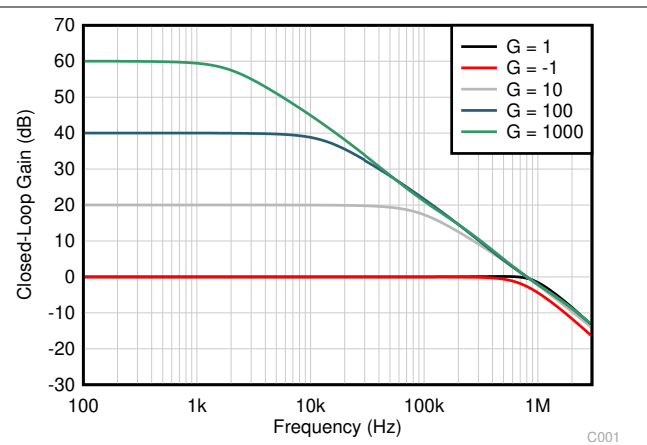

Figure 5-8. Closed-Loop Gain and Phase vs Frequency

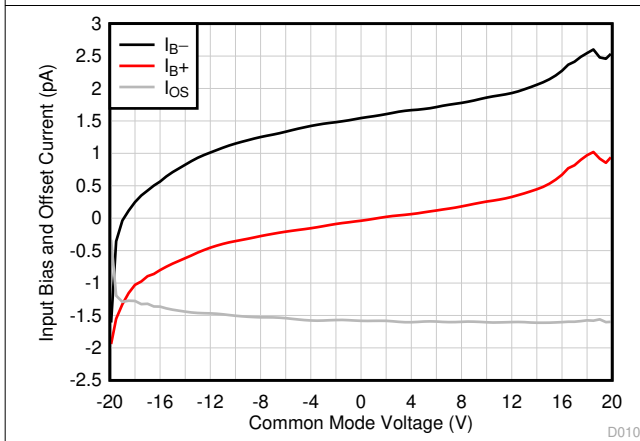

Figure 5-9. Input Bias Current vs Common-Mode Voltage

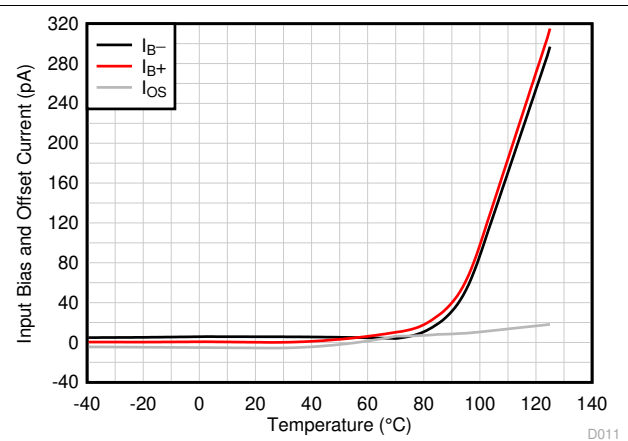

Figure 5-10. Input Bias Current vs Temperature

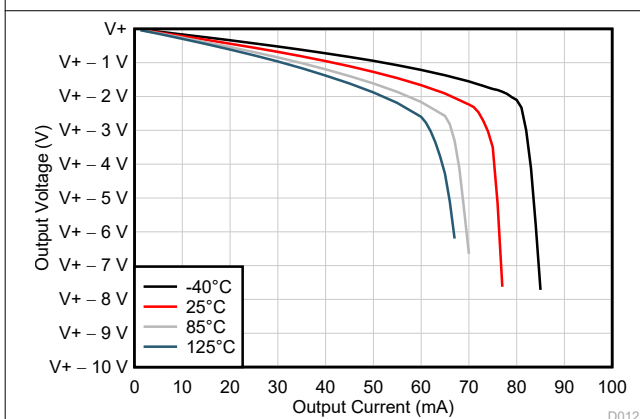

Figure 5-11. Output Voltage Swing vs Output Current (Sourcing)

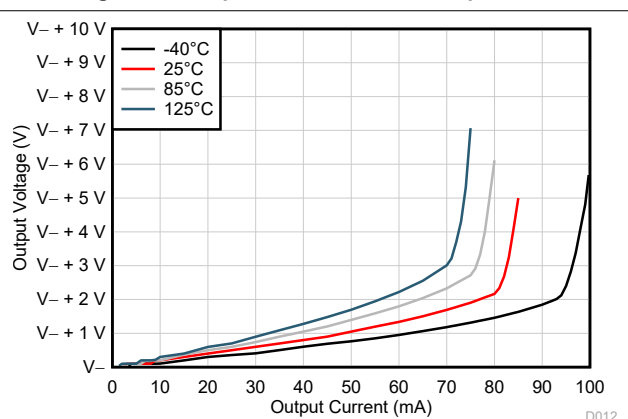

Figure 5-12. Output Voltage Swing vs Output Current (Sinking)

5.6 Typical Characteristics (continued)

at $T_A = 25^\circ\text{C}$, $V_S = \pm 20\text{V}$, $V_{CM} = V_S / 2$, $R_{LOAD} = 10\text{k}\Omega$ connected to $V_S / 2$, and $C_L = 100\text{pF}$ (unless otherwise noted)

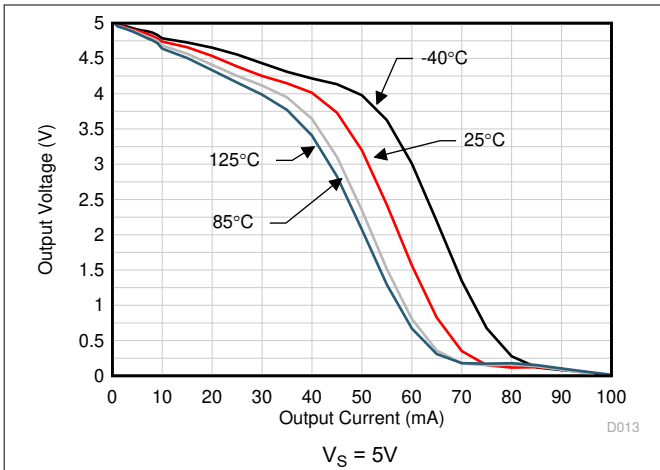

Figure 5-13. Output Voltage Swing vs Output Current (Sourcing)

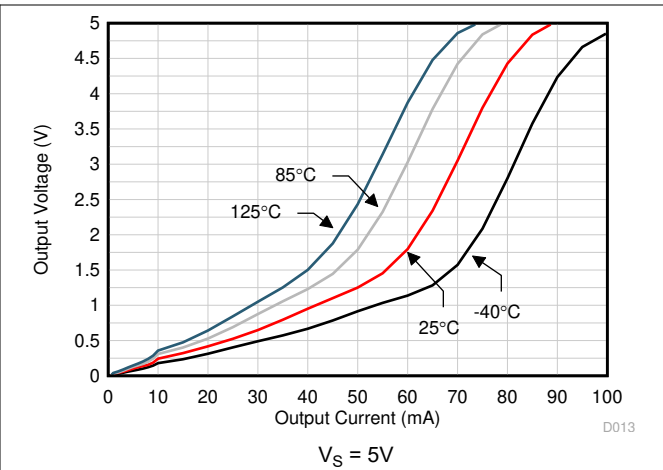

Figure 5-14. Output Voltage Swing vs Output Current (Sinking)

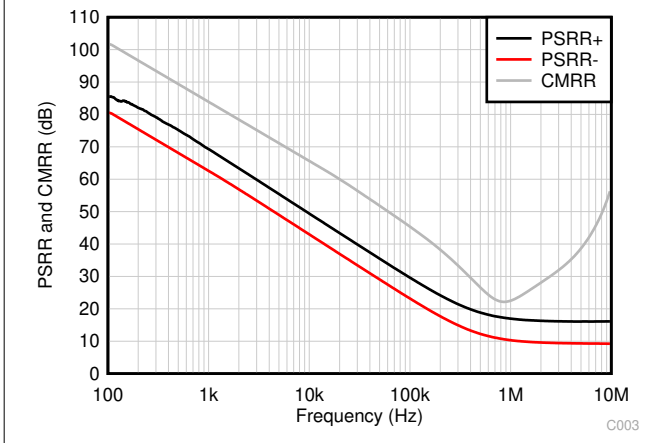

Figure 5-15. CMRR and PSRR vs Frequency

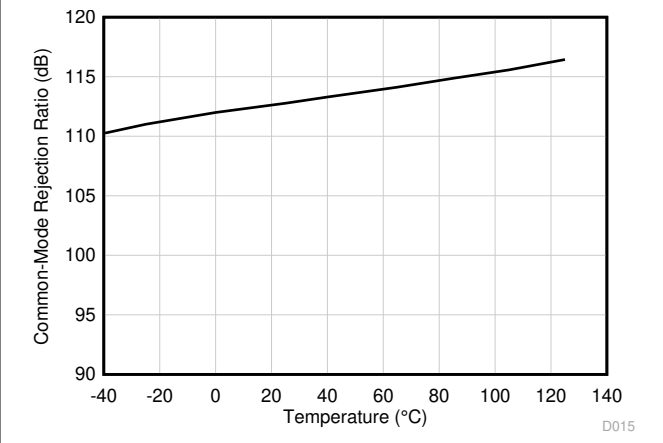

Figure 5-16. CMRR vs Temperature (dB)

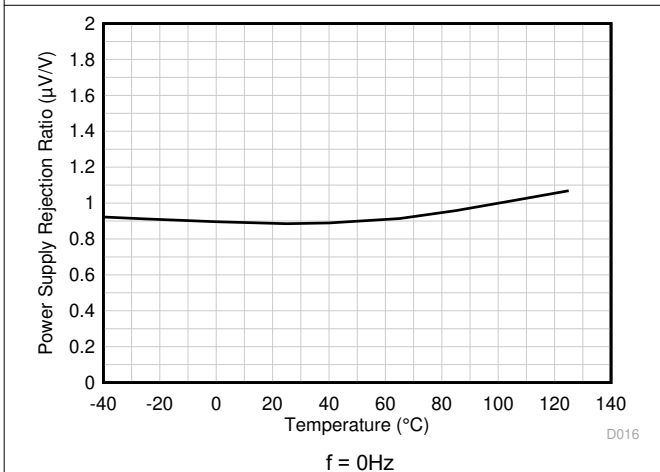

Figure 5-17. PSRR vs Temperature (dB)

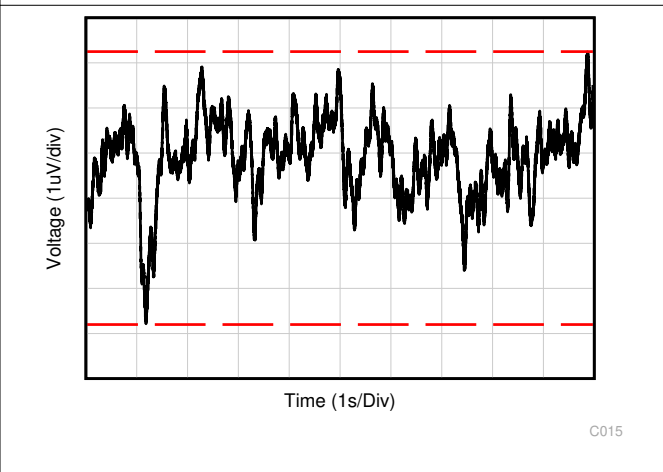

Figure 5-18. 0.1Hz to 10Hz Noise

5.6 Typical Characteristics (continued)

at $T_A = 25^\circ\text{C}$, $V_S = \pm 20\text{V}$, $V_{CM} = V_S / 2$, $R_{LOAD} = 10\text{k}\Omega$ connected to $V_S / 2$, and $C_L = 100\text{pF}$ (unless otherwise noted)

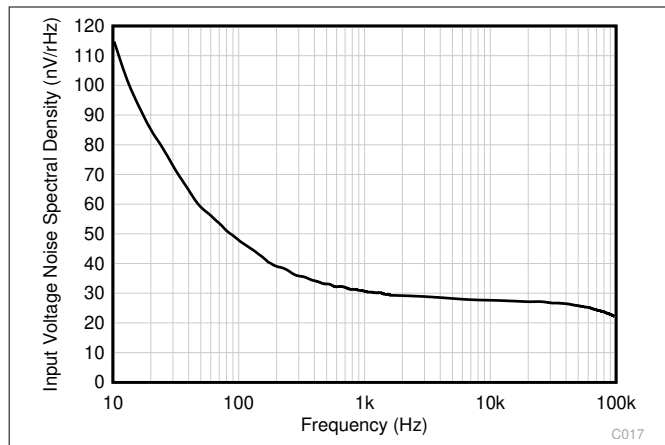
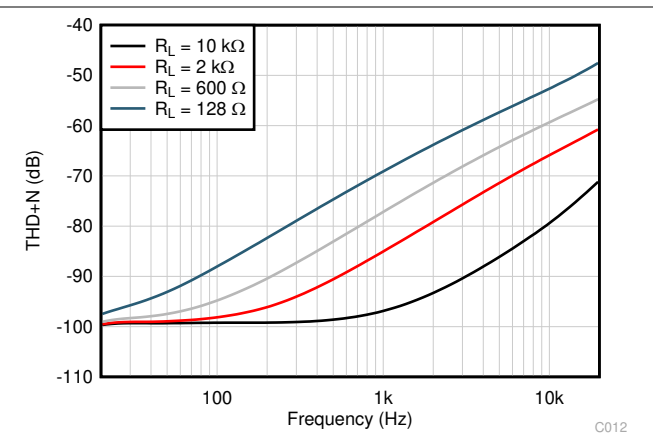
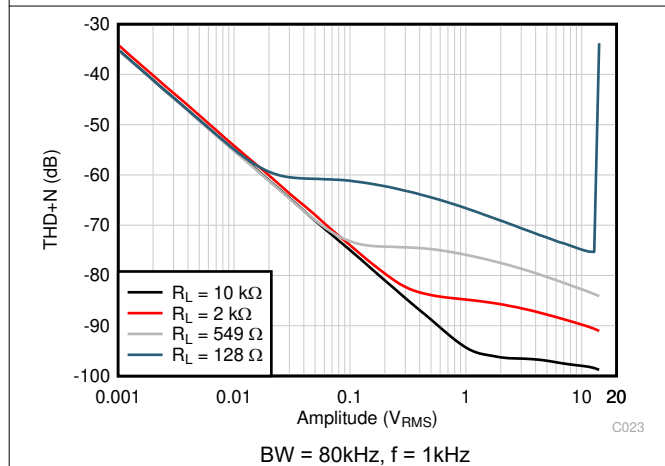

Figure 5-19. Input Voltage Noise Spectral Density vs Frequency



BW = 80kHz, $V_{OUT} = 3.5V_{RMS}$

Figure 5-20. THD+N Ratio vs Frequency



BW = 80kHz, $f = 1\text{ kHz}$

Figure 5-21. THD+N vs Output Amplitude

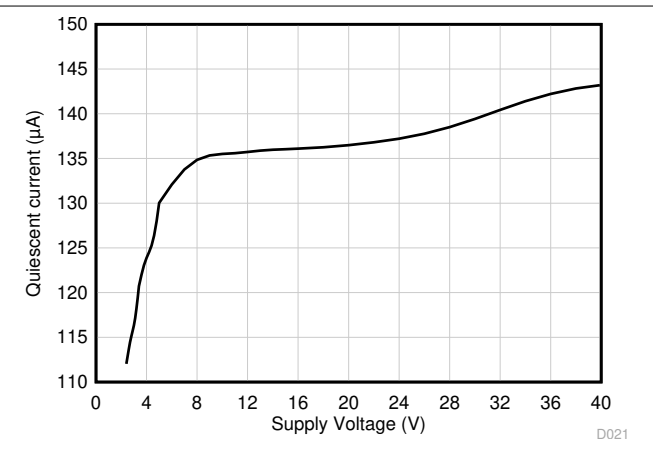

Figure 5-22. Quiescent Current vs Supply Voltage

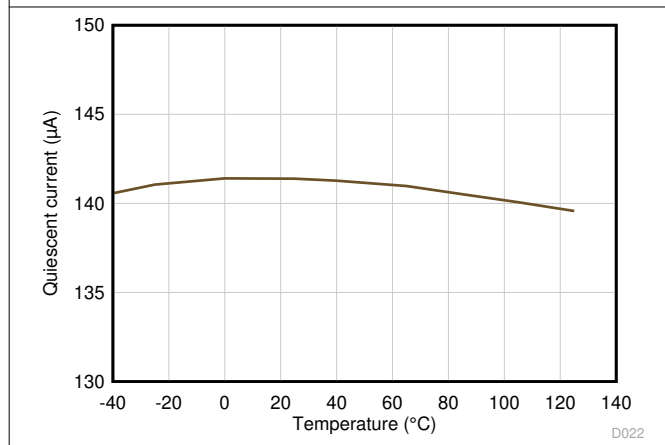

Figure 5-23. Quiescent Current vs Temperature

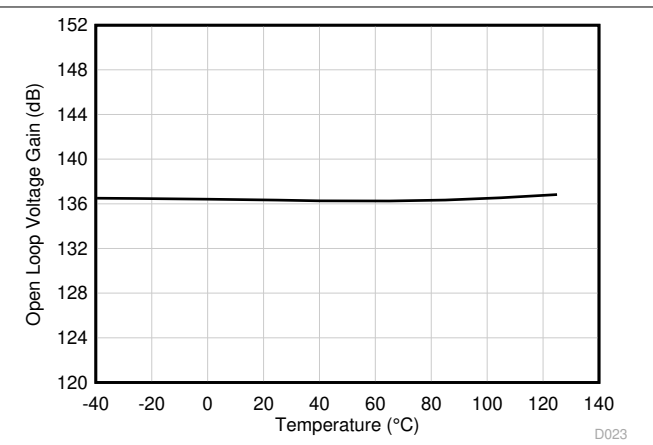

Figure 5-24. Open-Loop Voltage Gain vs Temperature (dB)

5.6 Typical Characteristics (continued)

at $T_A = 25^\circ\text{C}$, $V_S = \pm 20\text{V}$, $V_{CM} = V_S / 2$, $R_{LOAD} = 10\text{k}\Omega$ connected to $V_S / 2$, and $C_L = 100\text{pF}$ (unless otherwise noted)

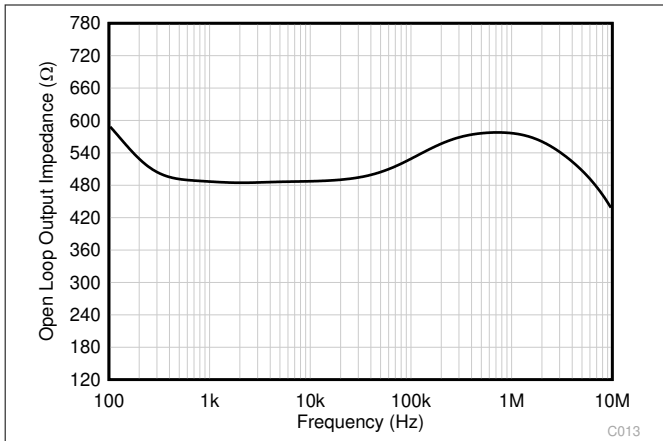
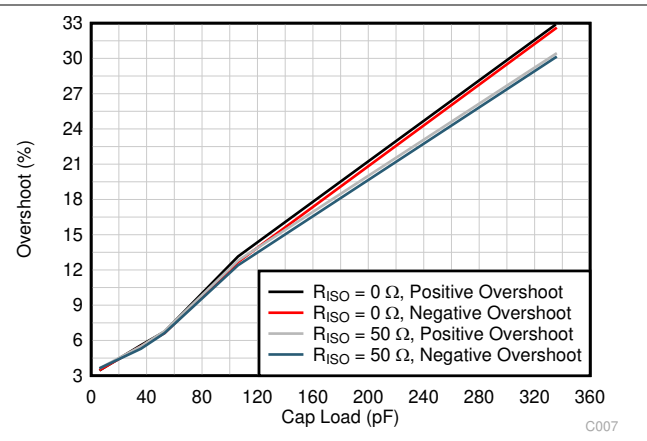
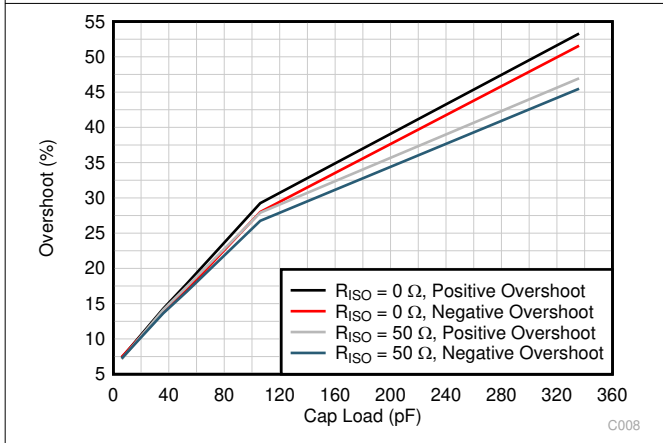

Figure 5-25. Open-Loop Output Impedance vs Frequency



$G = -1$, 100mV output step

Figure 5-26. Small-Signal Overshoot vs Capacitive Load



$G = 1$, 100mV output step

Figure 5-27. Small-Signal Overshoot vs Capacitive Load

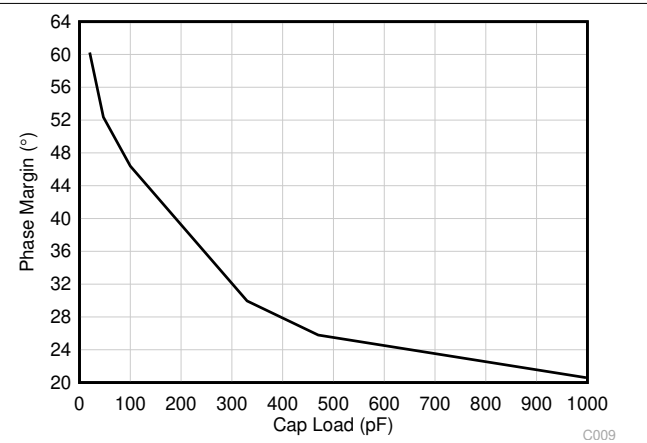

$G = -1$, 100mV output step

Figure 5-28. Small-Signal Overshoot vs Capacitive Load

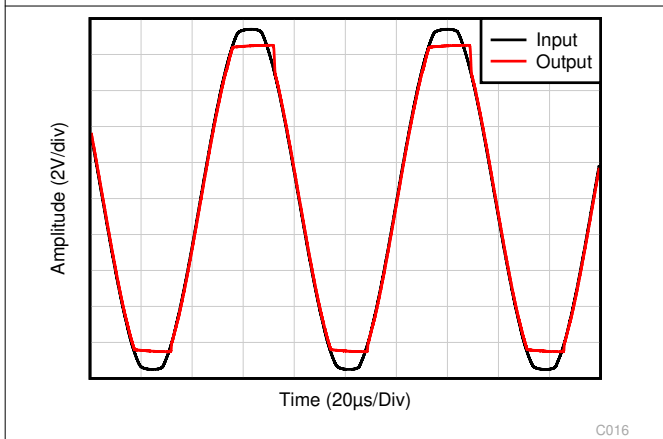
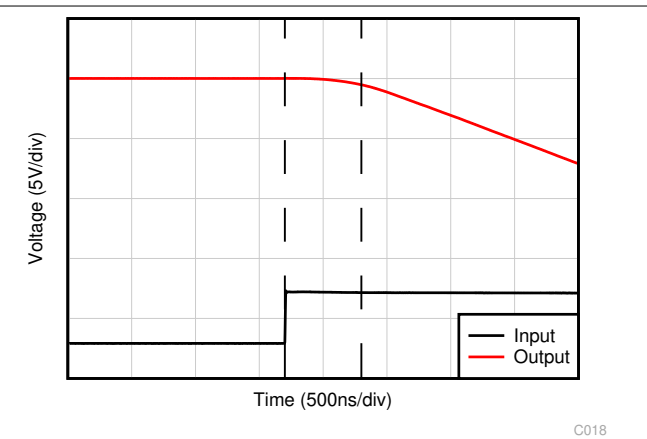

Figure 5-29. No Phase Reversal



$G = -10$

Figure 5-30. Positive Overload Recovery

5.6 Typical Characteristics (continued)

at $T_A = 25^\circ\text{C}$, $V_S = \pm 20\text{V}$, $V_{CM} = V_S / 2$, $R_{LOAD} = 10\text{k}\Omega$ connected to $V_S / 2$, and $C_L = 100\text{pF}$ (unless otherwise noted)

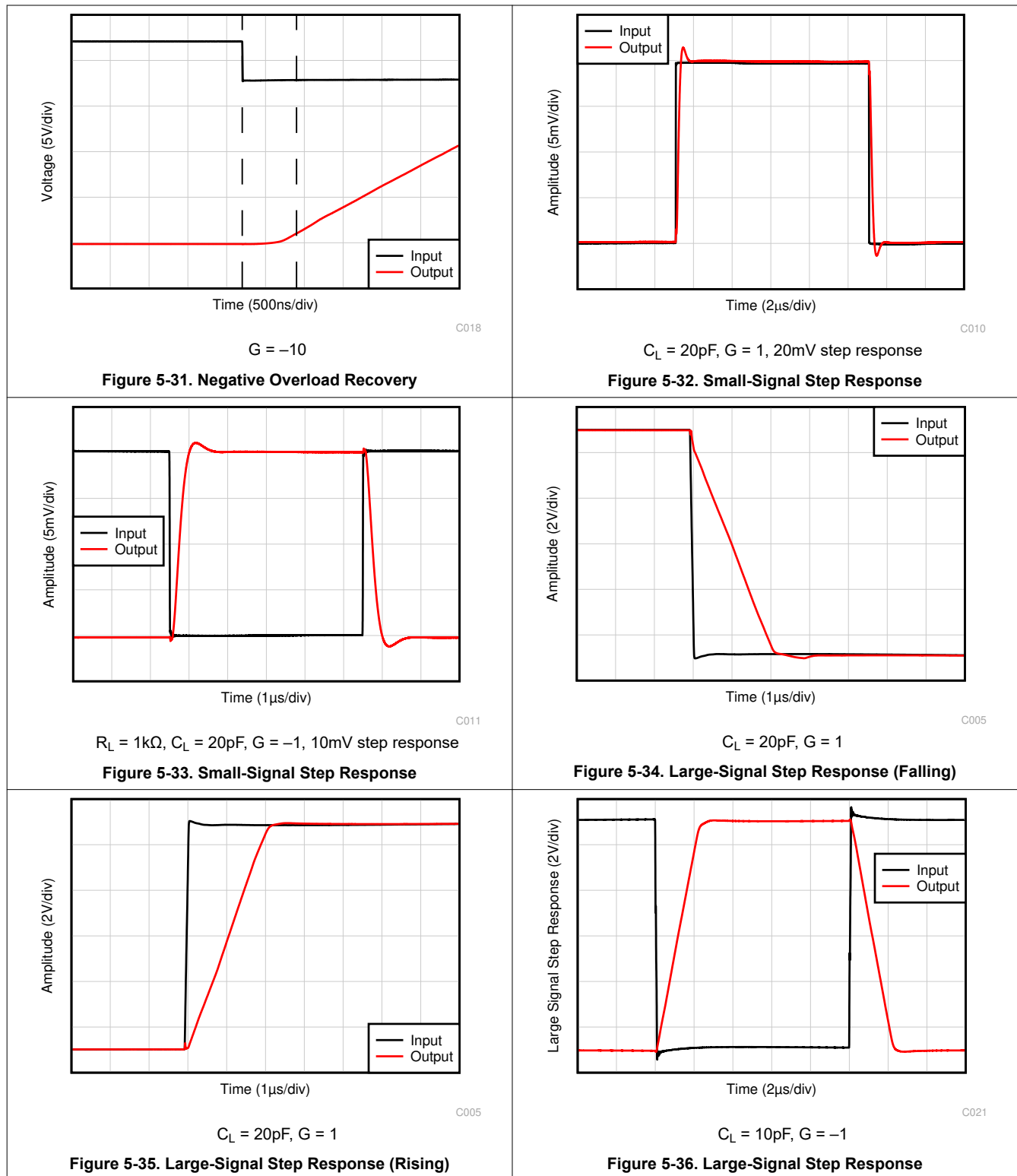

5.6 Typical Characteristics (continued)

at $T_A = 25^\circ\text{C}$, $V_S = \pm 20\text{V}$, $V_{CM} = V_S / 2$, $R_{LOAD} = 10\text{k}\Omega$ connected to $V_S / 2$, and $C_L = 100\text{pF}$ (unless otherwise noted)

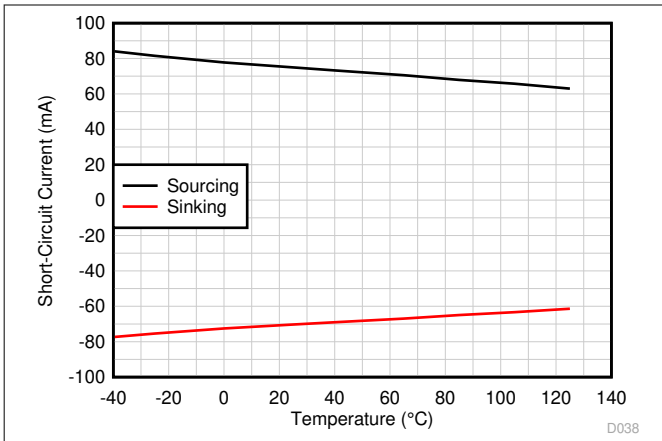

Figure 5-37. Short-Circuit Current vs Temperature

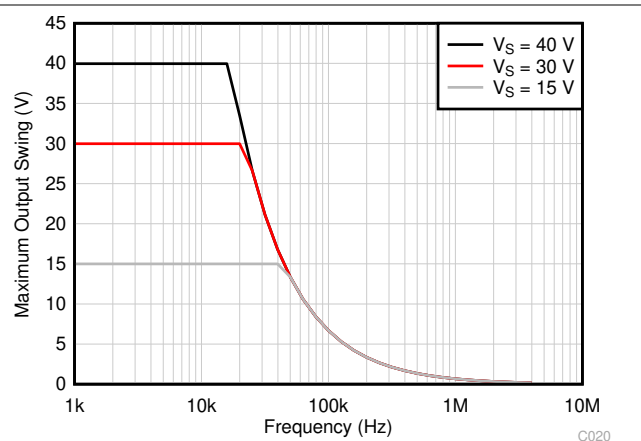

Figure 5-38. Maximum Output Voltage vs Frequency

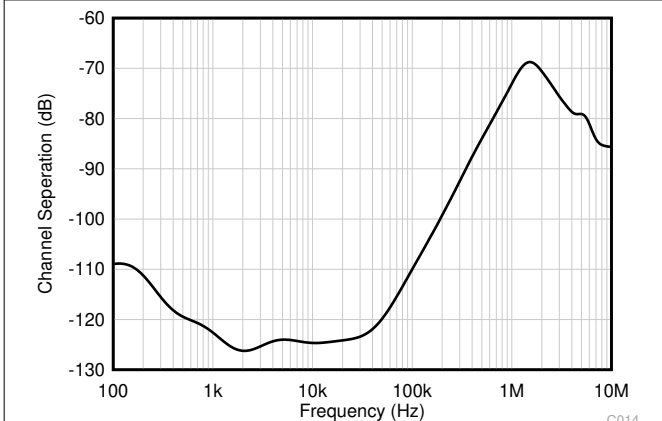

Figure 5-39. Channel Separation vs Frequency

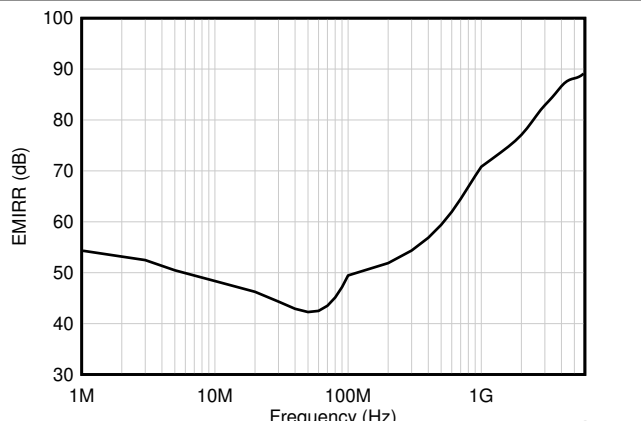

Figure 5-40. EMIRR (Electromagnetic Interference Rejection Ratio) vs Frequency

6 Detailed Description

6.1 Overview

The TLV930x-Q1 family (TLV9301-Q1, TLV9302-Q1, and TLV9304-Q1) is a family of 40V, cost-optimized operational amplifiers. These devices offer strong general-purpose DC and AC specifications, including rail-to-rail output, low offset ($\pm 0.5\text{mV}$, typical), low offset drift ($\pm 2\mu\text{V}/^\circ\text{C}$, typical), and 1MHz bandwidth. The TLV930x-Q1 implements a complementary input stage consisting of a matched PMOS pair and matched NMOS pair. The PMOS is optimized for performance and is operational over the majority of the common-mode range, but the TLV930x-Q1 also operates (at reduced performance) when the common mode is within the NMOS region.

The TLV930x-Q1 device family offers flexibility in a range of applications. For example, a high output current (60mA, typical) can be used in a variety of biasing and driving applications with low load impedance. Wide output voltage swing across supply voltage range allows the TLV930x-Q1 to maximize dynamic range and to operate with a variety of output loads. The output impedance of the device has a very resistive frequency response, meaning the output impedance across frequency is nearly flat, which makes the device simple to stabilize with any capacitive load. The TLV930x-Q1 integrates circuitry that protects the inputs under high differential voltage, a feature uncommon to cost-optimized devices. Anti-phase reversal and thermal protection circuitry are integrated, making the device a strong option in rugged environments. This family also includes slew boost functionality, which improves transient performance under large step response and input changes while reducing quiescent current.

6.2 Functional Block Diagram

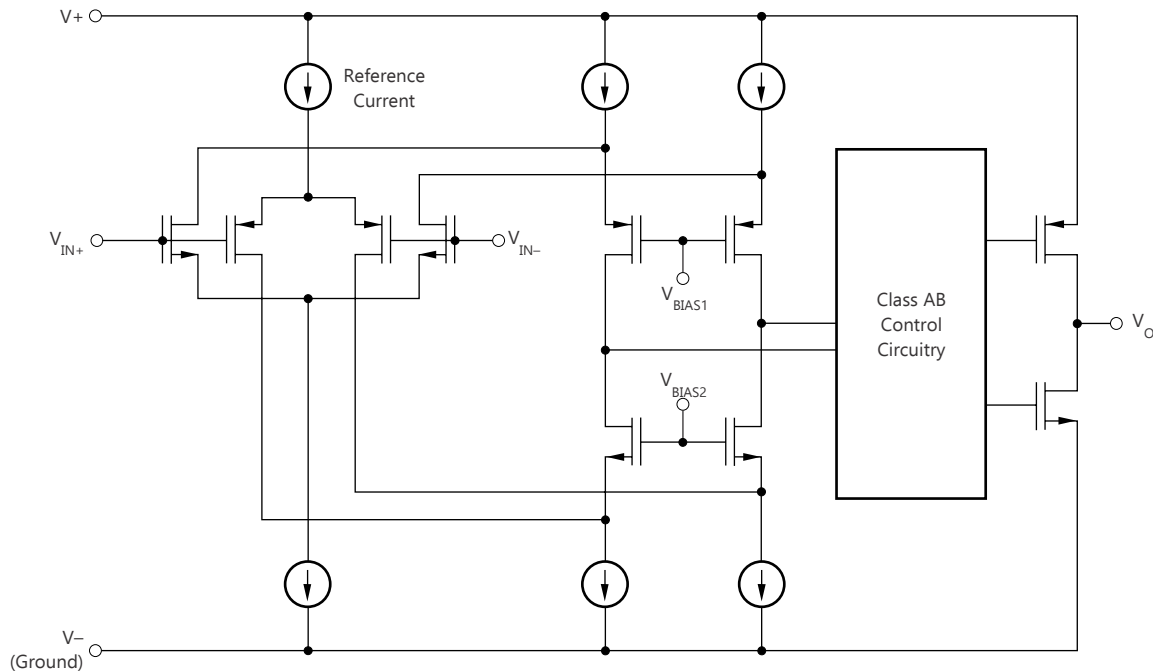

6.3 Feature Description

6.3.1 Input Protection Circuitry

The TLV930x-Q1 uses a patented input architecture to eliminate the requirement for input protection diodes but still provides robust input protection under transient conditions. Figure 6-1 shows conventional input diode protection schemes that are activated by fast transient step responses and introduce signal distortion and settling time delays because of alternate current paths, as shown in Figure 6-2. For low-gain circuits, these fast-ramping input signals forward-bias back-to-back diodes, causing an increase in input current and resulting in extended settling time.

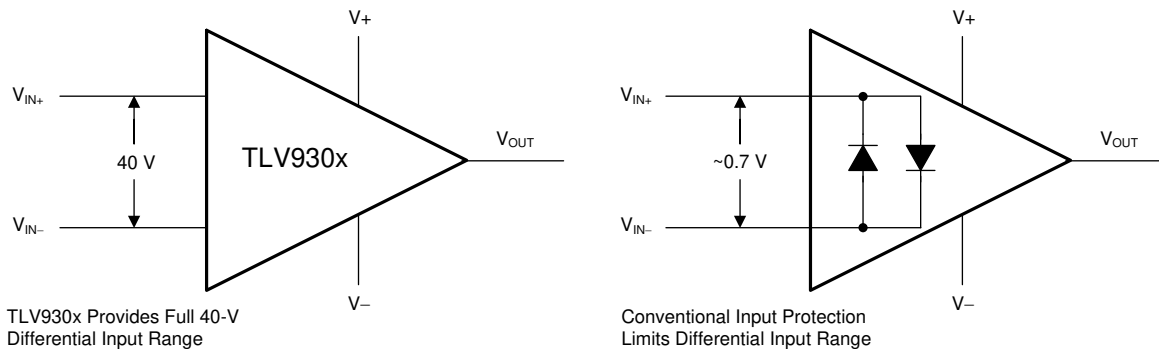

Figure 6-1. TLV930x-Q1 Input Protection Does Not Limit Differential Input Capability

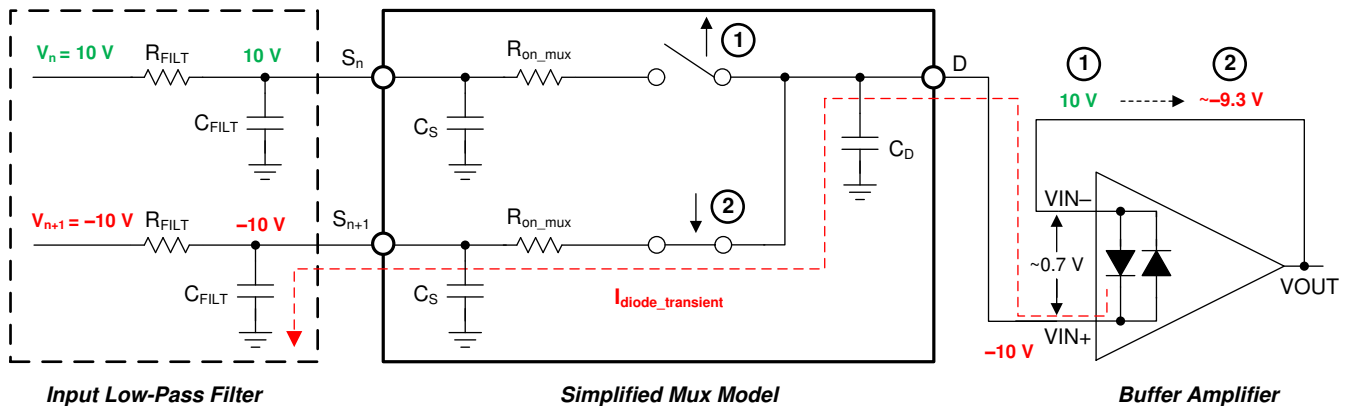

Figure 6-2. Back-to-Back Diodes Create Settling Issues

The TLV930x-Q1 family of operational amplifiers provides a true high-impedance differential input capability for high-voltage applications. This patented input protection architecture does not introduce additional signal distortion or delayed settling time, as the device is designed for multichannel, high-switched, input applications. The TLV930x-Q1 also tolerates a maximum differential swing (voltage between inverting and noninverting pins of the op amp) of up to 40V, therefore the device can be used as a comparator or in applications with fast-ramping input signals.

6.3.2 EMI Rejection

The TLV930x-Q1 uses integrated electromagnetic interference (EMI) filtering to reduce the effects of EMI from sources such as wireless communications and densely-populated boards with a mix of analog signal chain and digital components. EMI immunity can be improved with circuit design techniques; the TLV930x-Q1 benefits from these design improvements. Texas Instruments has developed the ability to accurately measure and quantify the immunity of an operational amplifier over a broad frequency spectrum extending from 10MHz to 6GHz. [Figure 6-3](#) shows the results of this testing on the TLV930x-Q1. [Table 6-1](#) shows the EMIRR IN+ values for the TLV930x-Q1 at particular frequencies commonly encountered in real-world applications. [Table 6-1](#) lists applications that may be centered on or operated near the particular frequency shown. The [EMI Rejection Ratio of Operational Amplifiers](#) application note contains detailed information on the topic of EMIRR performance as it relates to operational amplifiers.

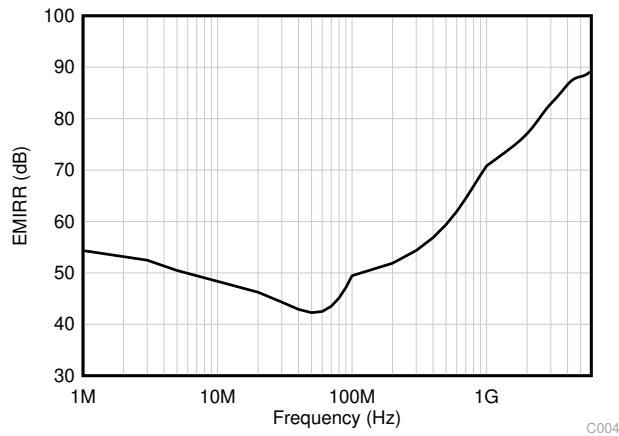

Figure 6-3. EMIRR Testing

Table 6-1. TLV930x-Q1 EMIRR IN+ for Frequencies of Interest

FREQUENCY	APPLICATION OR ALLOCATION	EMIRR IN+
400MHz	Mobile radio, mobile satellite, space operation, weather, radar, ultra-high frequency (UHF) applications	59.5dB
900MHz	Global system for mobile communications (GSM) applications, radio communication, navigation, GPS (to 1.6GHz), GSM, aeronautical mobile, UHF applications	68.9dB
1.8GHz	GSM applications, mobile personal communications, broadband, satellite, L-band (1GHz to 2GHz)	77.8dB
2.4GHz	802.11b, 802.11g, 802.11n, Bluetooth® wireless technology, mobile personal communications, industrial, scientific and medical (ISM) radio band, amateur radio and satellite, S-band (2GHz to 4GHz)	78.0dB
3.6GHz	Radiolocation, aero communication and navigation, satellite, mobile, S-band	88.8dB
5GHz	802.11a, 802.11n, aero communication and navigation, mobile communication, space and satellite operation, C-band (4GHz to 8GHz)	87.6dB

6.3.3 Phase Reversal Protection

The TLV930x-Q1 family has internal phase-reversal protection. Many op amps exhibit a phase reversal when the input is driven beyond the linear common-mode range. This condition is most often encountered in noninverting circuits when the input is driven beyond the specified common-mode voltage range, causing the output to reverse into the opposite rail. The TLV930x-Q1 is a rail-to-rail input op amp; therefore, the common-mode range can extend up to the rails. Input signals beyond the rails do not cause phase reversal; instead, the output limits into the appropriate rail. Figure 6-4 shows this performance.

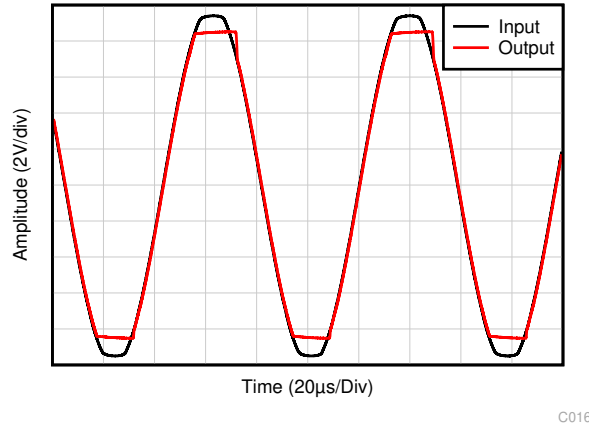

Figure 6-4. No Phase Reversal

6.3.4 Thermal Protection

The internal power dissipation of any amplifier causes the internal (junction) temperature to rise. This phenomenon is called *self heating*. The absolute maximum junction temperature of the TLV930x-Q1 is 150°C. Exceeding this temperature causes damage to the device. The TLV930x-Q1 has a thermal protection feature that prevents damage from self heating. The protection works by monitoring the temperature of the device and turning off the op amp output drive for temperatures above 140°C. Figure 6-5 shows an application example for the TLV9301-Q1 that has significant self heating (159°C) because of the power dissipation (0.81W). Thermal calculations indicate that for an ambient temperature of 65°C the device junction temperature must reach 187°C. The actual device, however, turns off the output drive to maintain a safe junction temperature. Figure 6-5 shows how the circuit behaves during thermal protection. During normal operation, the device acts as a buffer so the output is 3V. When self heating causes the device junction temperature to increase above 140°C, the thermal protection forces the output to a high-impedance state and the output is pulled to ground through resistor RL.

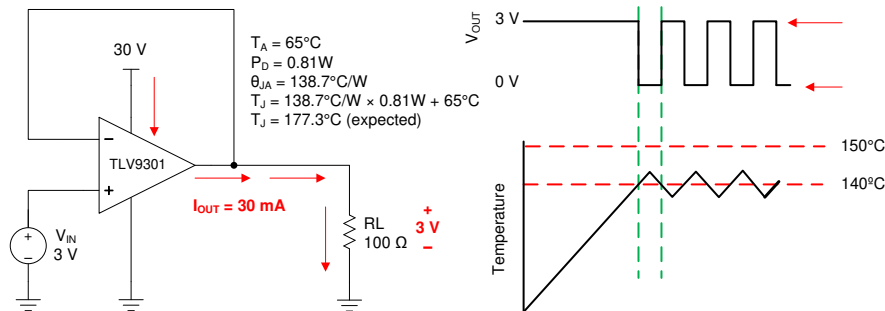
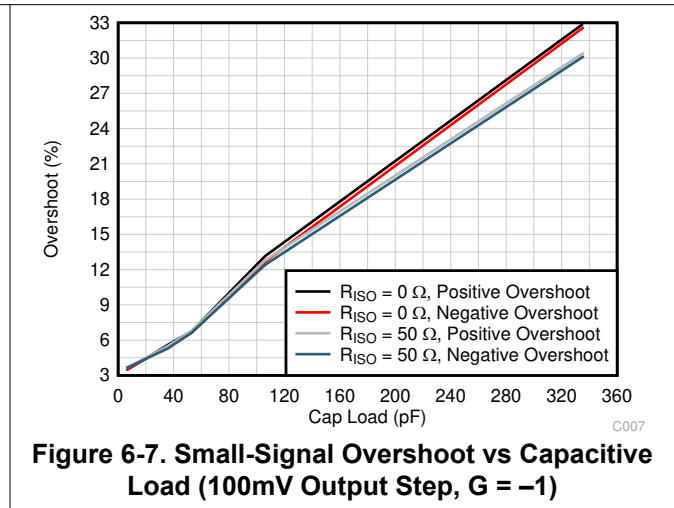
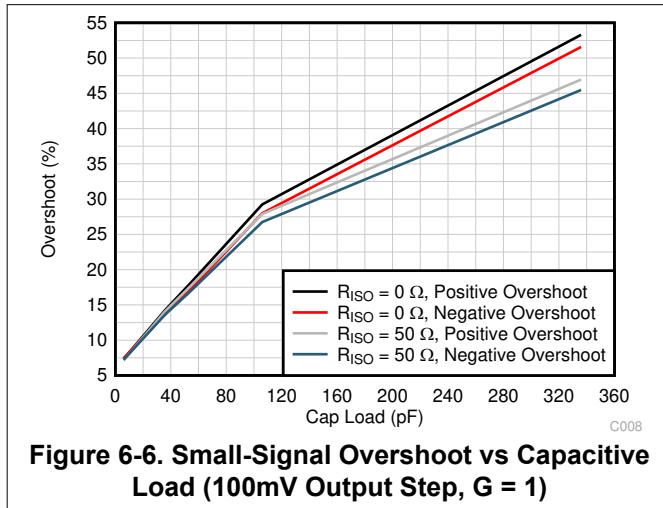

Figure 6-5. Thermal Protection

6.3.5 Capacitive Load and Stability

The TLV930x-Q1 features a resistive output stage capable of driving smaller capacitive loads, and by leveraging an isolation resistor, the device can easily be configured to drive large capacitive loads. Increasing the gain enhances the ability of the amplifier to drive greater capacitive loads; see [Figure 6-6](#) and [Figure 6-7](#). The particular op amp circuit configuration, layout, gain, and output loading are some of the factors to consider when establishing whether an amplifier is stable in operation.



For additional drive capability in unity-gain configurations, improve capacitive load drive by inserting a small (10Ω to 20Ω) resistor, R_{ISO} , in series with the output, as shown in [Figure 6-8](#). This resistor significantly reduces ringing and maintains DC performance for purely capacitive loads. However, if a resistive load is in parallel with the capacitive load, then a voltage divider is created, thus introducing a gain error at the output and slightly reducing the output swing. The error introduced is proportional to the ratio R_{ISO} / R_L , and is generally negligible at low output levels. The high capacitive load drive of the TLV930x-Q1 is designed for applications such as reference buffers, MOSFET gate drives, and cable-shield drives. The circuit shown in [Figure 6-8](#) uses an isolation resistor, R_{ISO} , to stabilize the output of an op amp. R_{ISO} modifies the open-loop gain of the system for increased phase margin. For additional information on techniques to optimize and design using this circuit, TI Precision Design [TIDU032](#) details complete design goals, simulation, and test results.

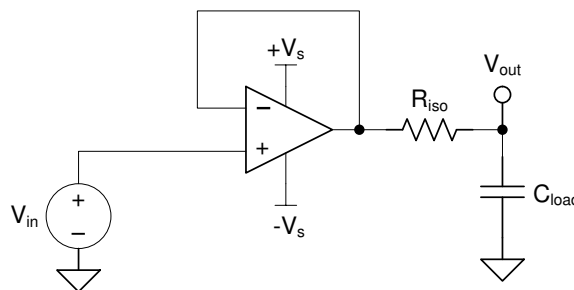

Figure 6-8. Extending Capacitive Load Drive With the TLV9301-Q1

6.3.6 Common-Mode Voltage Range

The TLV930x-Q1 is a 40V, rail-to-rail output operational amplifier with an input common-mode range that extends 100mV beyond V_- and within 2V of V_+ for normal operation. The device accomplishes this performance through a complementary input stage, using a P-channel differential pair. Additionally, a complementary N-channel differential pair has been included in parallel with the P-channel pair to eliminate common undesirable op amp behaviors, such as phase reversal.

The TLV930x-Q1 can operate with common mode ranges beyond 100mV of the top rail, but with reduced performance above $(V_+) - 2V$. The N-channel pair is active for input voltages close to the positive rail, typically $(V_+) - 1V$ to 100mV above the positive supply. The P-channel pair is active for inputs from 100mV below the negative supply to approximately $(V_+) - 2V$. There is a small transition region, typically $(V_+) - 2V$ to $(V_+) - 1V$ in which both input pairs are on. This transition region can vary modestly with process variation, and within the transition region and N-channel region, many specifications of the op amp (including PSRR, CMRR, offset voltage, offset drift, noise and THD performance) can be degraded compared to operation within the P-channel region.

Table 6-2. Typical Performance for Common-Mode Voltages Within 2V of the Positive Supply

PARAMETER	MIN	TYP	MAX	UNIT
Input common-mode voltage	$(V_+) - 2$		$(V_+) + 0.1$	V
Offset voltage		1.5		mV
Offset voltage drift		2		$\mu V/^\circ C$
Common-mode rejection		75		dB
Open-loop gain		75		dB
Gain-bandwidth product		0.7		MHz

6.3.7 Electrical Overstress

Designers often ask questions about the capability of an operational amplifier to withstand electrical overstress (EOS). These questions tend to focus on the device inputs, but can involve the supply voltage pins or even the output pin. Each of these different pin functions have electrical stress limits determined by the voltage breakdown characteristics of the particular semiconductor fabrication process and specific circuits connected to the pin. Additionally, internal electrostatic discharge (ESD) protection is built into these circuits to protect them from accidental ESD events both before and during product assembly.

A good understanding of this basic ESD circuitry and the relevance to an electrical overstress event is helpful. Figure 6-9 shows an illustration of the ESD circuits contained in the TLV930x-Q1 (indicated by the dashed line area). The ESD protection circuitry involves several current-steering diodes connected from the input and output pins and routed back to the internal power-supply lines, where the diodes meet at an absorption device or the power-supply ESD cell, internal to the operational amplifier. This protection circuitry is intended to remain inactive during normal circuit operation.

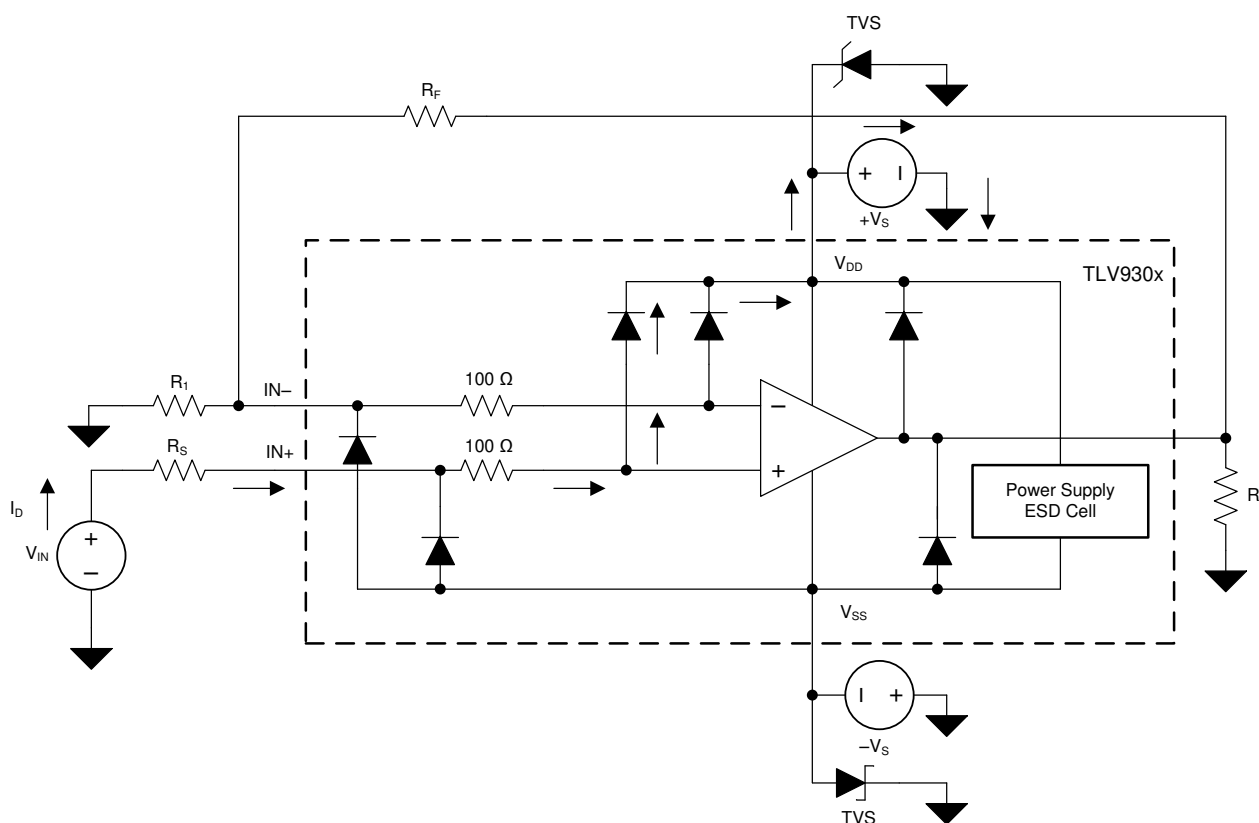

Figure 6-9. Equivalent Internal ESD Circuitry Relative to a Typical Circuit Application

An ESD event is very short in duration and very high voltage (for example, 1kV, 100ns), whereas an EOS event is long duration and lower voltage (for example, 50V, 100ms). The ESD diodes are designed for out-of-circuit ESD protection (that is, during assembly, test, and storage of the device before being soldered to the PCB). During an ESD event, the ESD signal is passed through the ESD steering diodes to an absorption circuit (labeled ESD power-supply circuit). The ESD absorption circuit clamps the supplies to a safe level.

Although this behavior is necessary for out-of-circuit protection, excessive current and damage is caused if activated in-circuit. Designers can use transient voltage suppressors (TVS) to prevent the device against damage caused by turning on the ESD absorption circuit during an in-circuit ESD event.

Make sure to use the appropriate current limiting resistors and TVS diodes to use the device ESD diodes and protect the device against EOS events.

6.3.8 Overload Recovery

Overload recovery is defined as the time required for the op amp output to recover from a saturated state to a linear state. The output devices of the op amp enter a saturation region when the output voltage exceeds the rated operating voltage, either due to the high input voltage or the high gain. After the device enters the saturation region, the charge carriers in the output devices require time to return back to the linear state. After the charge carriers return back to the linear state, the device begins to slew at the specified slew rate. Thus, the propagation delay in case of an overload condition is the sum of the overload recovery time and the slew time. The overload recovery time for the TLV930x-Q1 is approximately 1 μ s.

6.3.9 Typical Specifications and Distributions

Designers often ask about a typical specification of an amplifier when trying to design a more robust circuit. Due to natural variation in process technology and manufacturing procedures, every specification of an amplifier exhibits some amount of deviation from the ideal value, like the input offset voltage of an amplifier. These deviations often follow *Gaussian* ("bell curve"), or *normal* distributions, and circuit designers can leverage this information to guardband their system, even when there is not a minimum or maximum specification in [Electrical Characteristics](#).

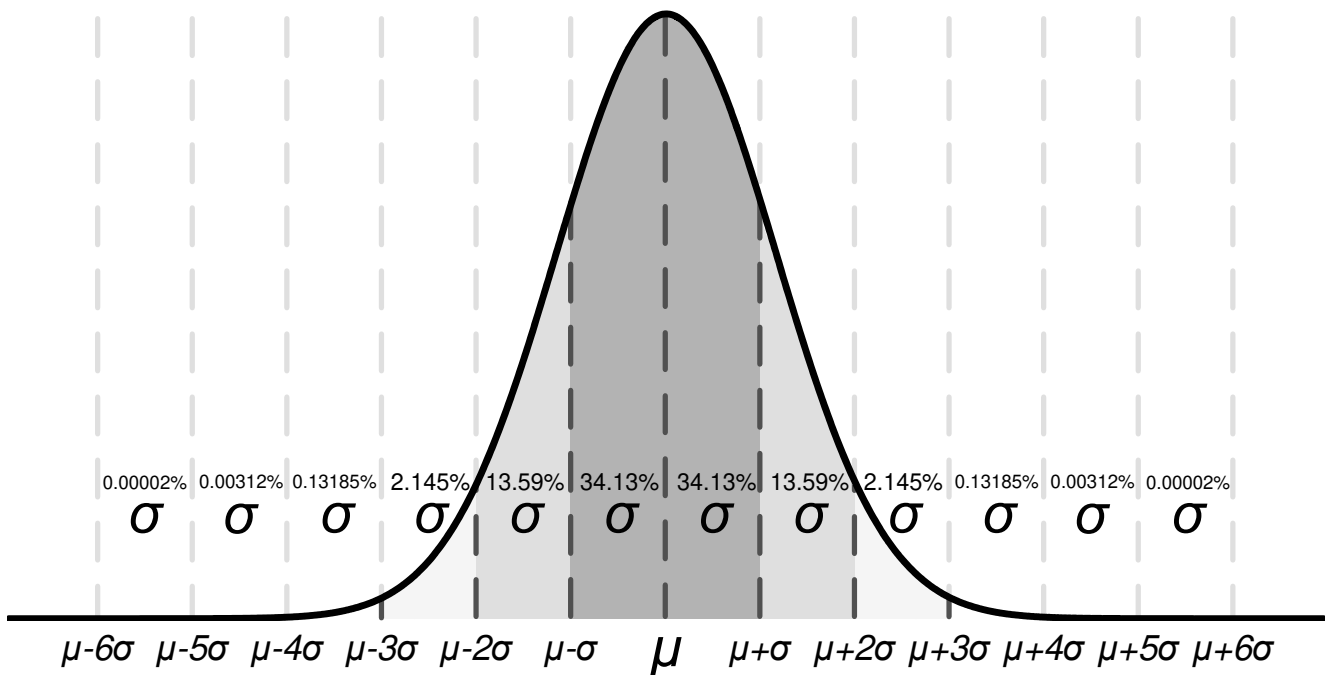

Figure 6-10. Ideal Gaussian Distribution

Figure 6-10 shows an example distribution, where μ , or mu , is the mean of the distribution, and where σ , or *sigma*, is the standard deviation of a system. For a specification that exhibits this kind of distribution, approximately two-thirds (68.26%) of all units can be expected to have a value within one standard deviation, or one sigma, of the mean (from $\mu - \sigma$ to $\mu + \sigma$).

Depending on the specification, values listed in the *typical* column in [Electrical Characteristics](#) are represented in different ways. As a general rule, if a specification naturally has a nonzero mean (for example, like gain bandwidth), then the typical value is equal to the mean (μ). However, if a specification naturally has a mean near zero (like input offset voltage), then the typical value is equal to the mean plus one standard deviation ($\mu + \sigma$) to more accurately represent the typical value.

Use this chart to calculate approximate probability of a specification in a unit; for example, the typical input voltage offset for the TLV930x-Q1 is $500\mu\text{V}$, so 68.2% of all TLV930x-Q1 devices are expected to have an offset from $-500\mu\text{V}$ to $+500\mu\text{V}$. At 4σ ($\pm 2000\mu\text{V}$), 99.9937% of the distribution has an offset voltage less than $\pm 2000\mu\text{V}$, which means 0.0063% of the population is outside of these limits, which corresponds to about 1 in 15,873 units.

If specifications have a value listed in the minimum or maximum columns, make sure your design specifications are not outside of these ranges.

For specifications with no value listed in the minimum or maximum column, consider selecting a sigma value of sufficient guardband for your application, and design worst-case conditions using this value. For example, the 6σ value corresponds to about 1 in 500 million units, which is an extremely unlikely chance, and can be an option as a wide guardband to design a system around. The TLV930x-Q1 family does not have a maximum or minimum for offset voltage drift in this case, but based on [Figure 5-2](#) and the typical value of $2\mu\text{V}/^\circ\text{C}$ in [Electrical Characteristics](#), calculations show that the 6σ value for offset voltage drift is about $12\mu\text{V}/^\circ\text{C}$. When designing for worst-case system conditions, this value can be used to estimate the worst possible offset across temperature without having an actual minimum or maximum value.

However, process variation and adjustments over time can shift typical means and standard deviations, therefore only use this information to estimate the performance of a device if no minimum or maximum values are listed.

6.4 Device Functional Modes

The TLV930x-Q1 has a single functional mode and is operational when the power-supply voltage is greater than 4.5V ($\pm 2.25\text{V}$). The maximum power supply voltage for the TLV930x-Q1 is 40V ($\pm 20\text{V}$).

7 Application and Implementation

Note

Information in the following applications sections is not part of the TI component specification, and TI does not warrant its accuracy or completeness. TI's customers are responsible for determining suitability of components for their purposes, as well as validating and testing their design implementation to confirm system functionality.

7.1 Application Information

The TLV930x-Q1 family offers excellent DC precision and DC performance. These devices operate up to 40V supply rails and offer true rail-to-rail input/output, low offset voltage and offset voltage drift, as well as 1MHz bandwidth and high output drive. These features make the TLV930x-Q1 a robust, high-performance operational amplifier for high-voltage industrial applications.

7.2 Typical Applications

7.2.1 High Voltage Precision Comparator

Many different systems require controlled voltages across numerous system nodes to ensure robust operation. A comparator can be used to monitor and control voltages by comparing a reference threshold voltage with an input voltage and providing an output when the input crosses this threshold.

The MUX-friendly input stage of TLV930x-Q1 op amp family allow designers to use these devices as high voltage comparators (see [Input Protection Circuitry](#)). Previous generation high-voltage op amps often use back-to-back diodes across the inputs to prevent damage to the op amp, which greatly limited a designer's capability to use these op amps as comparators. The patented input stage of the TLV930x-Q1, however, allows the device to have a wide differential voltage between the inputs.

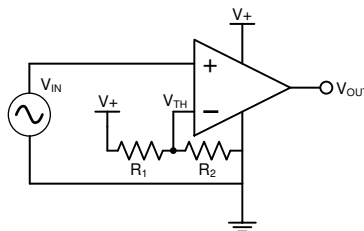

Figure 7-1. Typical Comparator Application

7.2.1.1 Design Requirements

The primary objective is to design a 40V precision comparator.

- System supply voltage (V_+): 40V
- Resistor 1 value: 100k Ω
- Resistor 2 value: 100k Ω
- Reference threshold voltage (V_{TH}): 20V
- Input voltage range (V_{IN}): 0V – 40V
- Output voltage range (V_{OUT}): 0V – 40V

7.2.1.2 Detailed Design Procedure

This noninverting comparator circuit applies the input voltage (V_{IN}) to the noninverting terminal of the op amp. Two resistors (R_1 and R_2) divide the supply voltage (V_+) to create a mid-supply threshold voltage (V_{TH}) as calculated in Equation 1. Figure 7-1 shows the circuit. When V_{IN} is less than V_{TH} , the output voltage transitions to the negative supply and equals the low-level output voltage. When V_{IN} is greater than V_{TH} , the output voltage transitions to the positive supply and equals the high-level output voltage.

In this example, resistor 1 and 2 reach 100k Ω , which sets the reference threshold at 20V. However, resistor 1 and 2 can be adjusted to modify the threshold using Equation 1. The values of resistors 1 and 2 were selected to reduce power consumption, but these values can be further increased to reduce power consumption, or reduced to improve noise performance.

$$V_{TH} = \frac{R_2}{R_1 + R_2} \times V_+ \quad (1)$$

7.2.1.3 Application Curve

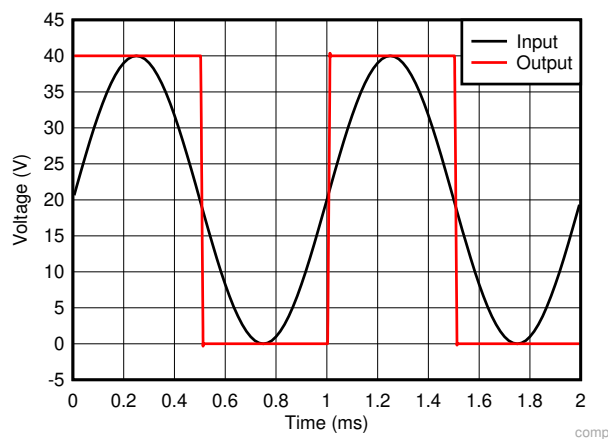

Figure 7-2. Comparator Output Response to Input Voltage

7.3 Power Supply Recommendations

The TLV930x-Q1 is specified for operation from 4.5V to 40V ($\pm 2.25V$ to $\pm 20V$); many specifications apply from $-40^\circ C$ to $125^\circ C$. Parameters that can exhibit significant variance with regard to operating voltage or temperature are presented in [Electrical Characteristics](#).

CAUTION

Supply voltages larger than 40V can permanently damage the device; see the [Absolute Maximum Ratings](#) table.

Place 0.1 μF bypass capacitors close to the power-supply pins to reduce errors coupling in from noisy or high-impedance power supplies. For more detailed information on bypass capacitor placement, refer to [Layout](#).

7.4 Layout

7.4.1 Layout Guidelines

For best operational performance of the device, use good PCB layout practices, including:

- Noise can propagate into analog circuitry through the power pins of the circuit as a whole and op amp itself, therefore use bypass capacitors to reduce the coupled noise by providing low-impedance power sources local to the analog circuitry.

- Connect low-ESR, 0.1 μ F ceramic bypass capacitors between each supply pin and ground, placed as close to the device as possible. A single bypass capacitor from V+ to ground is applicable for single-supply applications.
- Separate grounding for analog and digital portions of circuitry for one of the simplest and most-effective methods of noise suppression. One or more layers on multilayer PCBs are usually devoted to ground planes. A ground plane helps distribute heat and reduces EMI noise pickup. Make sure to physically separate digital and analog grounds paying attention to the flow of the ground current.
- To reduce parasitic coupling, run the input traces as far away from the supply or output traces as possible. If these traces cannot be kept separate, crossing the sensitive trace perpendicular is much better as opposed to in parallel with the noisy trace.
- Place the external components as close to the device as possible. As illustrated in Figure 7-4, keeping RF and RG close to the inverting input minimizes parasitic capacitance.
- Keep the length of input traces as short as possible. Always remember that the input traces are the most sensitive part of the circuit.
- Consider a driven, low-impedance guard ring around the critical traces. A guard ring can significantly reduce leakage currents from nearby traces that are at different potentials.
- Clean the PCB following the board assembly for best performance.
- Any precision integrated circuit can experience performance shifts due to moisture ingress into the plastic package, therefore bake the PCB assembly after any aqueous PCB cleaning process to remove moisture introduced into the device packaging during the cleaning process. A low temperature, post cleaning bake at 85°C for 30 minutes is sufficient for most circumstances.

7.4.2 Layout Example

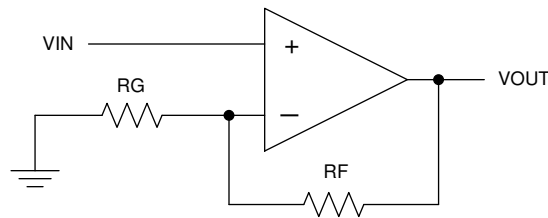

Figure 7-3. Schematic Representation

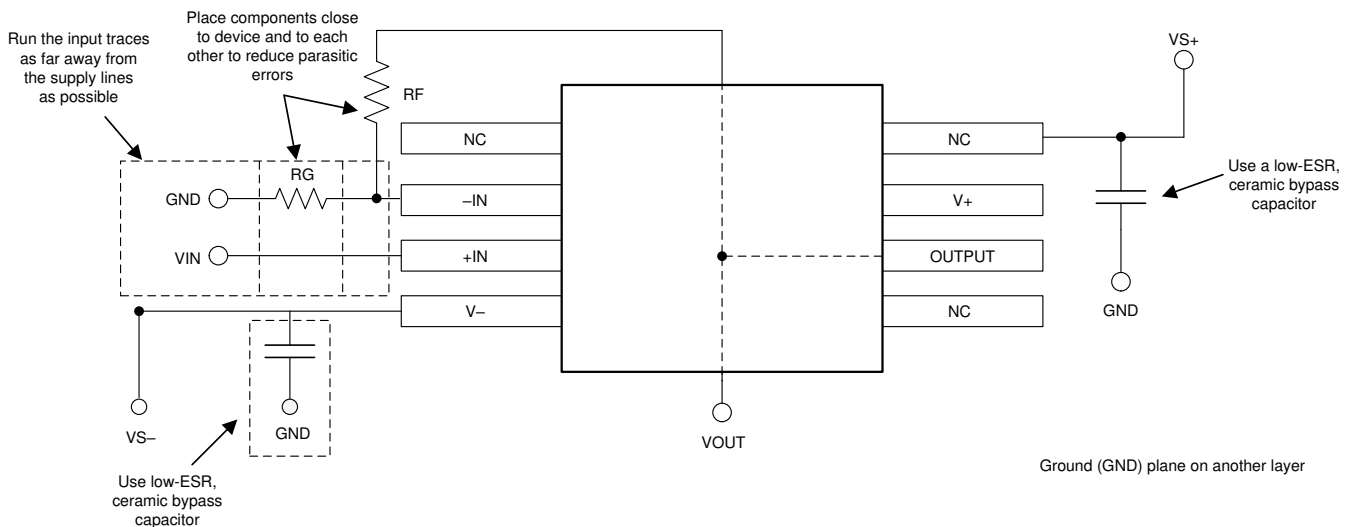

Figure 7-4. Operational Amplifier Board Layout for Noninverting Configuration

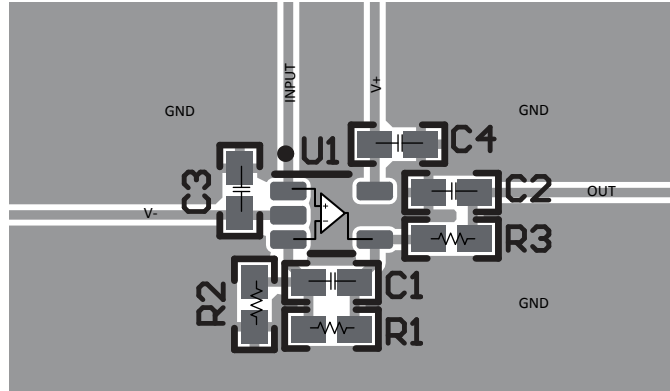

Figure 7-5. Example Layout for SC70 (DCK) Package

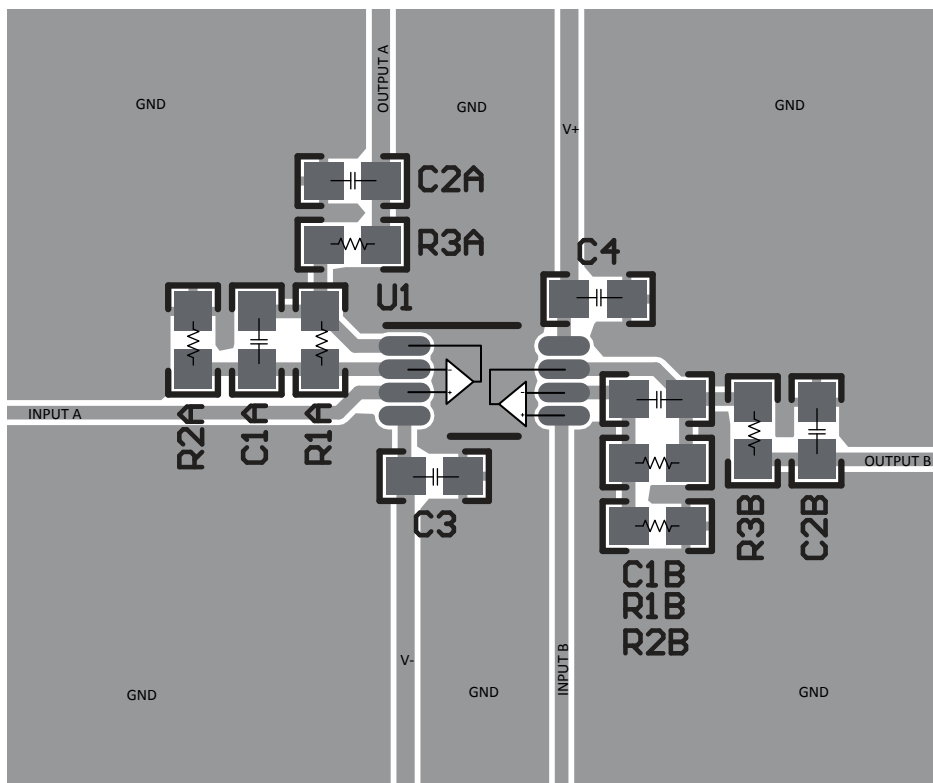

Figure 7-6. Example Layout for VSSOP-8 (DGK) Package

8 Device and Documentation Support

8.1 Device Support

8.1.1 Development Support

8.1.1.1 TINA-TI™ (Free Software Download)

TINA™ is a simple, powerful, and easy-to-use circuit simulation program based on a SPICE engine. TINA-TI is a free, fully-functional version of the TINA software, preloaded with a library of macro models in addition to a range of both passive and active models. TINA-TI provides all the conventional dc, transient, and frequency domain analysis of SPICE, as well as additional design capabilities.

Available as a [free download](#) from the Analog eLab Design Center, TINA-TI offers extensive post-processing capability that allows users to format results in a variety of ways. Virtual instruments offer the ability to select input waveforms and probe circuit nodes, voltages, and waveforms, creating a dynamic quick-start tool.

Note

These files require that either the TINA software (from DesignSoft™) or TINA-TI software be installed. Download the free TINA-TI software from the [TINA-TI folder](#).

8.2 Documentation Support

8.2.1 Related Documentation

Texas Instruments, [EMI Rejection Ratio of Operational Amplifiers application note](#)

Texas Instruments, [Capacitive Load Drive Solution using an Isolation Resistor reference design](#)

8.3 Receiving Notification of Documentation Updates

To receive notification of documentation updates, navigate to the device product folder on [ti.com](#). Click on *Notifications* to register and receive a weekly digest of any product information that has changed. For change details, review the revision history included in any revised document.

8.4 Support Resources

[TI E2E™ support forums](#) are an engineer's go-to source for fast, verified answers and design help — straight from the experts. Search existing answers or ask your own question to get the quick design help you need.

Linked content is provided "AS IS" by the respective contributors. They do not constitute TI specifications and do not necessarily reflect TI's views; see TI's [Terms of Use](#).

8.5 Trademarks

TINA-TI™ is a trademark of Texas Instruments, Inc and DesignSoft, Inc.

TINA™ and DesignSoft™ are trademarks of DesignSoft, Inc.

TI E2E™ is a trademark of Texas Instruments.

Bluetooth® is a registered trademark of Bluetooth SIG, Inc.

All trademarks are the property of their respective owners.

8.6 Electrostatic Discharge Caution



This integrated circuit can be damaged by ESD. Texas Instruments recommends that all integrated circuits be handled with appropriate precautions. Failure to observe proper handling and installation procedures can cause damage.

ESD damage can range from subtle performance degradation to complete device failure. Precision integrated circuits may be more susceptible to damage because very small parametric changes could cause the device not to meet its published specifications.

8.7 Glossary

[TI Glossary](#)

This glossary lists and explains terms, acronyms, and definitions.

9 Revision History

NOTE: Page numbers for previous revisions may differ from page numbers in the current version.

DATE	REVISION	NOTES
June 2024	*	Initial Release

10 Mechanical, Packaging, and Orderable Information

The following pages include mechanical, packaging, and orderable information. This information is the most current data available for the designated devices. This data is subject to change without notice and revision of this document. For browser-based versions of this data sheet, refer to the left-hand navigation.

PACKAGING INFORMATION

Orderable part number	Status (1)	Material type (2)	Package Pins	Package qty Carrier	RoHS (3)	Lead finish/ Ball material (4)	MSL rating/ Peak reflow (5)	Op temp (°C)	Part marking (6)
TLV9304QPWRQ1	Active	Production	TSSOP (PW) 14	3000 LARGE T&R	Yes	NIPDAU	Level-1-260C-UNLIM	-40 to 125	T9304PW
TLV9304QPWRQ1.A	Active	Production	TSSOP (PW) 14	3000 LARGE T&R	Yes	NIPDAU	Level-1-260C-UNLIM	-40 to 125	T9304PW

(1) **Status:** For more details on status, see our [product life cycle](#).

(2) **Material type:** When designated, preproduction parts are prototypes/experimental devices, and are not yet approved or released for full production. Testing and final process, including without limitation quality assurance, reliability performance testing, and/or process qualification, may not yet be complete, and this item is subject to further changes or possible discontinuation. If available for ordering, purchases will be subject to an additional waiver at checkout, and are intended for early internal evaluation purposes only. These items are sold without warranties of any kind.

(3) **RoHS values:** Yes, No, RoHS Exempt. See the [TI RoHS Statement](#) for additional information and value definition.

(4) **Lead finish/Ball material:** Parts may have multiple material finish options. Finish options are separated by a vertical ruled line. Lead finish/Ball material values may wrap to two lines if the finish value exceeds the maximum column width.

(5) **MSL rating/Peak reflow:** The moisture sensitivity level ratings and peak solder (reflow) temperatures. In the event that a part has multiple moisture sensitivity ratings, only the lowest level per JEDEC standards is shown. Refer to the shipping label for the actual reflow temperature that will be used to mount the part to the printed circuit board.

(6) **Part marking:** There may be an additional marking, which relates to the logo, the lot trace code information, or the environmental category of the part.

Multiple part markings will be inside parentheses. Only one part marking contained in parentheses and separated by a "~" will appear on a part. If a line is indented then it is a continuation of the previous line and the two combined represent the entire part marking for that device.

Important Information and Disclaimer:The information provided on this page represents TI's knowledge and belief as of the date that it is provided. TI bases its knowledge and belief on information provided by third parties, and makes no representation or warranty as to the accuracy of such information. Efforts are underway to better integrate information from third parties. TI has taken and continues to take reasonable steps to provide representative and accurate information but may not have conducted destructive testing or chemical analysis on incoming materials and chemicals. TI and TI suppliers consider certain information to be proprietary, and thus CAS numbers and other limited information may not be available for release.

In no event shall TI's liability arising out of such information exceed the total purchase price of the TI part(s) at issue in this document sold by TI to Customer on an annual basis.

OTHER QUALIFIED VERSIONS OF TLV9304-Q1 :

- Catalog : [TLV9304](#)

NOTE: Qualified Version Definitions:

- Catalog - TI's standard catalog product

PW0014A



PACKAGE OUTLINE
TSSOP - 1.2 mm max height

SMALL OUTLINE PACKAGE



4220202/B 12/2023

NOTES:

1. All linear dimensions are in millimeters. Any dimensions in parenthesis are for reference only. Dimensioning and tolerancing per ASME Y14.5M.
2. This drawing is subject to change without notice.
3. This dimension does not include mold flash, protrusions, or gate burrs. Mold flash, protrusions, or gate burrs shall not exceed 0.15 mm per side.
4. This dimension does not include interlead flash. Interlead flash shall not exceed 0.25 mm per side.
5. Reference JEDEC registration MO-153.

EXAMPLE BOARD LAYOUT

PW0014A

TSSOP - 1.2 mm max height

SMALL OUTLINE PACKAGE



LAND PATTERN EXAMPLE
EXPOSED METAL SHOWN
SCALE: 10X



4220202/B 12/2023

NOTES: (continued)

- 6. Publication IPC-7351 may have alternate designs.
- 7. Solder mask tolerances between and around signal pads can vary based on board fabrication site.

EXAMPLE STENCIL DESIGN

PW0014A

TSSOP - 1.2 mm max height

SMALL OUTLINE PACKAGE



SOLDER PASTE EXAMPLE
BASED ON 0.125 mm THICK STENCIL
SCALE: 10X

4220202/B 12/2023

NOTES: (continued)

8. Laser cutting apertures with trapezoidal walls and rounded corners may offer better paste release. IPC-7525 may have alternate design recommendations.
9. Board assembly site may have different recommendations for stencil design.

IMPORTANT NOTICE AND DISCLAIMER

TI PROVIDES TECHNICAL AND RELIABILITY DATA (INCLUDING DATASHEETS), DESIGN RESOURCES (INCLUDING REFERENCE DESIGNS), APPLICATION OR OTHER DESIGN ADVICE, WEB TOOLS, SAFETY INFORMATION, AND OTHER RESOURCES "AS IS" AND WITH ALL FAULTS, AND DISCLAIMS ALL WARRANTIES, EXPRESS AND IMPLIED, INCLUDING WITHOUT LIMITATION ANY IMPLIED WARRANTIES OF MERCHANTABILITY, FITNESS FOR A PARTICULAR PURPOSE OR NON-INFRINGEMENT OF THIRD PARTY INTELLECTUAL PROPERTY RIGHTS.

These resources are intended for skilled developers designing with TI products. You are solely responsible for (1) selecting the appropriate TI products for your application, (2) designing, validating and testing your application, and (3) ensuring your application meets applicable standards, and any other safety, security, regulatory or other requirements.

These resources are subject to change without notice. TI grants you permission to use these resources only for development of an application that uses the TI products described in the resource. Other reproduction and display of these resources is prohibited. No license is granted to any other TI intellectual property right or to any third party intellectual property right. TI disclaims responsibility for, and you fully indemnify TI and its representatives against any claims, damages, costs, losses, and liabilities arising out of your use of these resources.

TI's products are provided subject to [TI's Terms of Sale](#), [TI's General Quality Guidelines](#), or other applicable terms available either on ti.com or provided in conjunction with such TI products. TI's provision of these resources does not expand or otherwise alter TI's applicable warranties or warranty disclaimers for TI products. Unless TI explicitly designates a product as custom or customer-specified, TI products are standard, catalog, general purpose devices.

TI objects to and rejects any additional or different terms you may propose.

Copyright © 2025, Texas Instruments Incorporated

Last updated 10/2025