

## TPS22958x 5.5-V, 4-A / 6-A, 14-mΩ Load Switch with Adjustable Rise Time

### 1 Features

- Integrated N-Channel Load Switch
- Input Voltage Range: 0.6 V to 5.5 V
- VBIAS Voltage Range: 2.5 V to 5.5 V
- $R_{ON}$  Resistance
  - $R_{ON} = 14\text{ m}\Omega$  at  $V_{IN} = 5\text{ V}$  ( $V_{BIAS} = 5\text{ V}$ )
  - $R_{ON} = 13\text{ m}\Omega$  at  $V_{IN} = 3.3\text{ V}$  ( $V_{BIAS} = 5\text{ V}$ )
  - $R_{ON} = 13\text{ m}\Omega$  at  $V_{IN} = 1.8\text{ V}$  ( $V_{BIAS} = 5\text{ V}$ )
- 4 A Maximum Continuous Switch Current (DGK Package)
- 6 A Maximum Continuous Switch Current (DGN Package)
- Low Quiescent Current
  - $55\text{ }\mu\text{A}$  at  $V_{BIAS} = 5\text{ V}$
- Low Control Input Threshold Enables Use of 1.2 V/1.8 V/2.5 V/3.3 V Logic
- Adjustable Rise Time<sup>(1)</sup>
- Quick Output Discharge (QOD)<sup>(2)</sup>
- DGK 8-Pin Package:
  - 3.0 mm x 4.9 mm x 1.1 mm and 0.65 mm pitch
- DGN 8-Pin Package with Thermal Pad:
  - 3.0 mm x 4.9 mm x 1.1 mm and 0.65 mm pitch
- ESD Performance Tested per JEDEC STD.
  - 2-kV HBM and 1-kV CDM
- Latch-Up Performance Exceeds 100 mA per JESD 78, Class II
- GPIO Enable – Active High

(1) See [Adjustable Rise Time](#) section for CT value vs. rise time

(2) Not featured in the TPS22958N device.

### 2 Applications

- EPOS
- Factory Automation/Control
- Building Automation
- Printers
- Wave Soldering Manufacturing

### 3 Description

The TPS22958x is a small, single channel load switch with an adjustable rise time. The device contains an N-Channel MOSFET that can operate over an input voltage range of 0.6 V to 5.5 V and can support a maximum continuous current of 4 A (DGK package) or 6 A (DGN package). The switch is controlled by an on/off input, which is capable of interfacing directly with low voltage control signals.

The rise time of the device can be externally controlled in order to avoid inrush current. Attaching a capacitor to the CT pin will change the rise time: increasing the value of the capacitor will increase the rise time. The TPS22958x is available in two space-saving packages (DGK and DGN) with or without a thermal pad for high power dissipation. The device is characterized for operation over the free-air temperature range of  $-40^{\circ}\text{C}$  to  $105^{\circ}\text{C}$ .

#### Device Information<sup>(1)</sup>

PART NUMBER	PACKAGE (PIN)	BODY SIZE (NOM)
TPS22958x	DGK (8)	3.00 mm x 4.90 mm
	DGN (8)	3.00 mm x 4.90 mm

(1) For all available packages, see the orderable addendum at the end of the data sheet.

### Typical Application Schematic

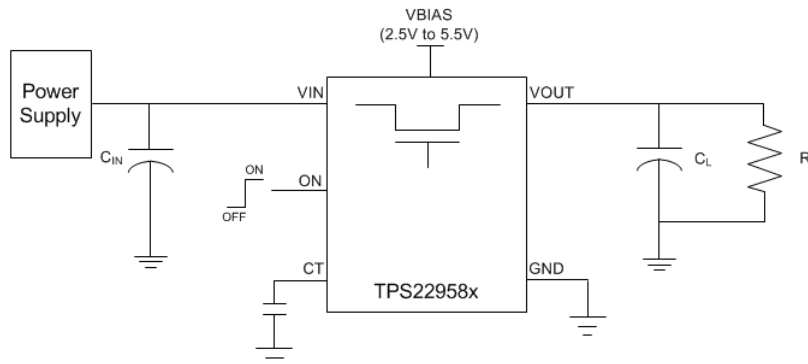

## Table of Contents

<b>1</b>	<b>Features</b> .....	<b>1</b>	<b>9</b>	<b>Detailed Description</b> .....	<b>17</b>
<b>2</b>	<b>Applications</b> .....	<b>1</b>	9.1	Overview .....	17
<b>3</b>	<b>Description</b> .....	<b>1</b>	9.2	Functional Block Diagram .....	17
<b>4</b>	<b>Revision History</b> .....	<b>2</b>	9.3	Feature Description .....	17
<b>5</b>	<b>Device Comparison Table</b> .....	<b>3</b>	9.4	Device Functional Modes .....	19
<b>6</b>	<b>Pin Configuration and Functions</b> .....	<b>3</b>	<b>10</b>	<b>Application and Implementation</b> .....	<b>20</b>
<b>7</b>	<b>Specifications</b> .....	<b>4</b>	10.1	Application Information .....	20
7.1	Absolute Maximum Ratings .....	4	10.2	Typical Application .....	21
7.2	ESD Ratings .....	4	<b>11</b>	<b>Power Supply Recommendations</b> .....	<b>24</b>
7.3	Recommended Operating Conditions .....	4	<b>12</b>	<b>Layout</b> .....	<b>24</b>
7.4	Thermal Information .....	5	12.1	Layout Guidelines .....	24
7.5	Electrical Characteristics ( $V_{BIAS} = 5\text{ V}$ ) .....	6	12.2	Layout Example .....	25
7.6	Electrical Characteristics ( $V_{BIAS} = 3.3\text{ V}$ ) .....	7	<b>13</b>	<b>Device and Documentation Support</b> .....	<b>26</b>
7.7	Electrical Characteristics ( $V_{BIAS} = 2.5\text{ V}$ ) .....	8	13.1	Related Links .....	26
7.8	Switching Characteristics .....	9	13.2	Trademarks .....	26
7.9	Typical DC Characteristics .....	10	13.3	Electrostatic Discharge Caution .....	26
7.10	Typical AC Characteristics .....	13	13.4	Glossary .....	26
<b>8</b>	<b>Parameter Measurement Information</b> .....	<b>16</b>	<b>14</b>	<b>Mechanical, Packaging, and Orderable Information</b> .....	<b>26</b>

## 4 Revision History

### Changes from Original (January 2014) to Revision A

Page

•	Initial release of full version. ....	1
---	---------------------------------------	---

## 5 Device Comparison Table

DEVICE	$R_{ON}$ AT VIN = VBIAS = 5V	RISE TIME	QUICK OUTPUT DISCHARGE	MAX OUTPUT CURRENT	ENABLE
TPS22958DGK	14 mΩ	Adjustable	Yes	4 A	Active High
TPS22958DGN		Adjustable	Yes	6 A	
TPS22958NDGK		Adjustable	No	4 A	
TPS22958NDGN		Adjustable	No	6 A	

## 6 Pin Configuration and Functions

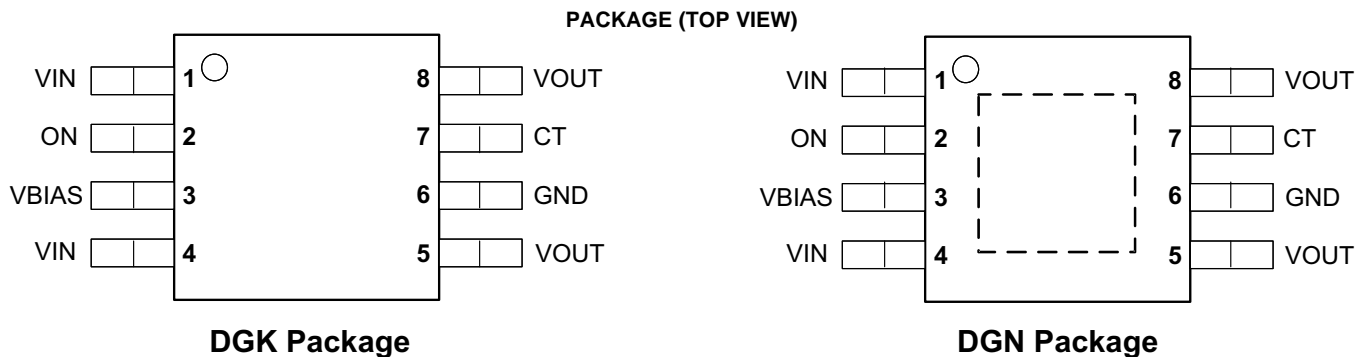

### Pin Functions

PIN		I/O	DESCRIPTION
NO.	NAME		
1, 4	VIN	I	Switch input. Bypass this input with a ceramic capacitor to GND. These pins should be tied together as shown in Layout Information.
2	ON	I	Active-high switch control input. Do not leave floating.
3	VBIAS	I	Bias voltage. Power supply to the device. Recommended voltage range for this pin is 2.5 to 5.5 V. See <a href="#">VIN and VBIAS Voltage Range</a> .
5, 8	VOUT	O	Switch output
6	GND	—	Ground
7	CT	O	Switch slew rate control. Can be left floating.
—	Thermal Pad <sup>(1)</sup>	—	Thermal pad (exposed center pad) to alleviate thermal stress. Tie to GND. See <a href="#">Layout Guidelines</a> for layout guidelines.

(1) Only available for the DGN package

## 7 Specifications

### 7.1 Absolute Maximum Ratings

Over operating free-air temperature (unless otherwise noted)<sup>(1) (2)</sup>

		MIN	MAX	UNIT
V <sub>IN</sub>	Input voltage	-0.3	6	V
V <sub>BIAS</sub>	Bias voltage	-0.3	6	V
V <sub>OUT</sub>	Output voltage	-0.3	6	V
V <sub>ON</sub>	ON voltage	-0.3	6	V
I <sub>MAX</sub>	Maximum continuous switch current, T <sub>A</sub> = 65°C (DGK Package)		4	A
	Maximum continuous switch current, T <sub>A</sub> = 75°C (DGN Package)		6	A
I <sub>PLS</sub>	Maximum pulsed switch current, pulse <300 μs, 2% duty cycle (DGK Package)		6	A
	Maximum pulsed switch current, pulse <300 μs, 2% duty cycle (DGN Package)		8	A
T <sub>J</sub>	Maximum junction temperature		125	°C
T <sub>stg</sub>	Storage temperature range	-65	150	°C

- (1) Stresses beyond those listed under *Absolute Maximum Ratings* may cause permanent damage to the device. These are stress ratings only, and functional operation of the device at these or any other conditions beyond those indicated under *Recommended Operating Conditions* is not implied. Exposure to absolute-maximum-rated conditions for extended periods may affect device reliability.
- (2) All voltage values are with respect to network ground terminal.

### 7.2 ESD Ratings

		VALUE	UNIT
V <sub>(ESD)</sub>	Electrostatic discharge	Human-body model (HBM), per ANSI/ESDA/JEDEC JS-001 <sup>(1)</sup>	±2000
		Charged-device model (CDM), per JEDEC specification JESD22-C101 <sup>(2)</sup>	±1000

- (1) JEDEC document JEP155 states that 500-V HBM allows safe manufacturing with a standard ESD control process. Manufacturing with less than 500-V HBM is possible with the necessary precautions.
- (2) JEDEC document JEP157 states that 250-V CDM allows safe manufacturing with a standard ESD control process. Manufacturing with less than 250-V CDM is possible with the necessary precautions.

### 7.3 Recommended Operating Conditions

			MIN	MAX	UNIT
V <sub>IN</sub>	Input voltage range		0.6	V <sub>BIAS</sub>	V
V <sub>BIAS</sub>	Bias voltage range		2.5	5.5	V
V <sub>ON</sub>	ON voltage range		0	5.5	V
V <sub>OUT</sub>	Output voltage range			V <sub>IN</sub>	V
V <sub>IH, ON</sub>	High-level input voltage, ON	V <sub>BIAS</sub> = 2.5 to 5.5 V	1.2	5.5	V
V <sub>IL, ON</sub>	Low-level input voltage, ON	V <sub>BIAS</sub> = 2.5 to 5.5 V	0	0.5	V
T <sub>A</sub>	Operating free-air temperature <sup>(1)</sup>		-40	105	°C
C <sub>IN</sub>	Input capacitor		1 <sup>(2)</sup>		μF

- (1) In applications where high power dissipation and/or poor package thermal resistance is present, the maximum ambient temperature may have to be derated. Maximum ambient temperature [T<sub>A(max)</sub>] is dependent on the maximum operating junction temperature [T<sub>J(max)</sub>], the maximum power dissipation of the device in the application [P<sub>D(max)</sub>], and the junction-to-ambient thermal resistance of the part/package in the application (R<sub>θJA</sub>), as given by the following equation: T<sub>A(max)</sub> = T<sub>J(max)</sub> - (R<sub>θJA</sub> × P<sub>D(max)</sub>).
- (2) Refer to the [Application Information](#) section.

## 7.4 Thermal Information

THERMAL METRIC <sup>(1)</sup> (2)		TPS22958x		UNIT
		DGK (8 PINS)	DGN (8 PINS)	
R <sub>θJA</sub>	Junction-to-ambient thermal resistance	185.7	67.0	°C/W
R <sub>θJC(top)</sub>	Junction-to-case (top) thermal resistance	77.3	66.5	
R <sub>θJB</sub>	Junction-to-board thermal resistance	107.0	46.8	
Ψ <sub>JT</sub>	Junction-to-top characterization parameter	15.2	5.0	
Ψ <sub>JB</sub>	Junction-to-board characterization parameter	105.4	46.6	
R <sub>θJC(bot)</sub>	Junction-to-case (bottom) thermal resistance	n/a	14.9	

(1) For more information about traditional and new thermal metrics, see the *IC Package Thermal Metrics* application report, [SPRA953](#).

(2) For thermal estimates of this device based on PCB copper area, see the *TI PCB Thermal Calculator*.

## 7.5 Electrical Characteristics ( $V_{BIAS} = 5\text{ V}$ )

Unless otherwise noted, the specification in the following table applies over the operating ambient temperature  $-40^{\circ}\text{C} \leq T_A \leq 105^{\circ}\text{C}$  and  $V_{BIAS} = 5\text{ V}$ . Typical values are for  $T_A = 25^{\circ}\text{C}$  (unless otherwise noted).

PARAMETER		TEST CONDITIONS	$T_A$	MIN	TYP	MAX	UNIT		
<b>POWER SUPPLIES AND CURRENTS</b>									
$I_Q, V_{BIAS}$	$V_{BIAS}$ quiescent current	$I_{OUT} = 0, V_{IN} = V_{ON} = V_{BIAS} = 5\text{ V}$	-40°C to 85°C	54	60		$\mu\text{A}$		
			-40°C to 105°C		60				
$I_{SD}, V_{BIAS}$	$V_{BIAS}$ shutdown current	$V_{ON} = 0\text{ V}, V_{OUT} = 0\text{ V}, V_{BIAS} = 5\text{ V}$	-40°C to 85°C	0.5	1		$\mu\text{A}$		
			-40°C to 105°C		1				
$I_{SD}, V_{IN}$	$V_{IN}$ shutdown current	$V_{ON} = 0\text{ V}, V_{OUT} = 0\text{ V}, V_{BIAS} = 5\text{ V}$	$V_{IN} = 5\text{ V}$	-40°C to 85°C	0.5	8	$\mu\text{A}$		
				-40°C to 105°C		10			
			$V_{IN} = 3.3\text{ V}$	-40°C to 85°C	0.1	3			
				-40°C to 105°C		4			
			$V_{IN} = 1.8\text{ V}$	-40°C to 85°C	0.07	2			
				-40°C to 105°C		3			
			$V_{IN} = 1.2\text{ V}$	-40°C to 85°C	0.05	1			
				-40°C to 105°C		2			
$V_{IN} = 0.6\text{ V}$	-40°C to 85°C	0.04	1						
	-40°C to 105°C		2						
$I_{ON}$	ON pin input leakage current	$V_{ON} = 5.5\text{ V}, V_{BIAS} = 5\text{ V}$	-40°C to 105°C		0.1	$\mu\text{A}$			
<b>RESISTANCE CHARACTERISTICS</b>									
$R_{ON}$	ON-state resistance	$I_{OUT} = -200\text{ mA}, V_{BIAS} = 5\text{ V}$	$V_{IN} = 5\text{ V}$	25°C	14	18	$\text{m}\Omega$		
				-40°C to 85°C		20			
				-40°C to 105°C		24			
			$V_{IN} = 3.3\text{ V}$	25°C	13	17	$\text{m}\Omega$		
				-40°C to 85°C		20			
				-40°C to 105°C		23			
			$V_{IN} = 2.5\text{ V}$	25°C	13	17	$\text{m}\Omega$		
				-40°C to 85°C		20			
				-40°C to 105°C		23			
			$V_{IN} = 1.8\text{ V}$	25°C	13	17	$\text{m}\Omega$		
				-40°C to 85°C		20			
				-40°C to 105°C		23			
			$V_{IN} = 1.5\text{ V}$	25°C	13	17	$\text{m}\Omega$		
				-40°C to 85°C		20			
				-40°C to 105°C		23			
			$V_{IN} = 1.2\text{ V}$	25°C	13	17	$\text{m}\Omega$		
				-40°C to 85°C		20			
				-40°C to 105°C		23			
			$V_{IN} = 0.6\text{ V}$	25°C	13	17	$\text{m}\Omega$		
				-40°C to 85°C		20			
				-40°C to 105°C		23			
			$R_{PD}$	Output pulldown resistance	$V_{IN} = V_{BIAS} = 5\text{ V}, V_{ON} = 0\text{ V}, I_{OUT} = 10\text{ mA}$	-40°C to 105°C	135	160	$\Omega$

## 7.6 Electrical Characteristics ( $V_{BIAS} = 3.3\text{ V}$ )

Unless otherwise noted, the specification in the following table applies over the operating ambient temperature  $-40^{\circ}\text{C} \leq T_A \leq 105^{\circ}\text{C}$  and  $V_{BIAS} = 3.3\text{ V}$ . Typical values are for  $T_A = 25^{\circ}\text{C}$  (unless otherwise noted).

PARAMETER		TEST CONDITIONS	$T_A$	MIN	TYP	MAX	UNIT	
<b>POWER SUPPLIES AND CURRENTS</b>								
$I_Q, V_{BIAS}$	$V_{BIAS}$ quiescent current	$I_{OUT} = 0, V_{IN} = V_{ON} = V_{BIAS} = 3.3\text{ V}$	$-40^{\circ}\text{C}$ to $85^{\circ}\text{C}$	23	27		$\mu\text{A}$	
			$-40^{\circ}\text{C}$ to $105^{\circ}\text{C}$			27		
$I_{SD}, V_{BIAS}$	$V_{BIAS}$ shutdown current	$V_{ON} = 0\text{ V}, V_{OUT} = 0\text{ V}, V_{BIAS} = 3.3\text{ V}$	$-40^{\circ}\text{C}$ to $85^{\circ}\text{C}$	0.3	0.7		$\mu\text{A}$	
			$-40^{\circ}\text{C}$ to $105^{\circ}\text{C}$			0.7		
$I_{SD}, V_{IN}$	$V_{IN}$ shutdown current	$V_{ON} = 0\text{ V}, V_{OUT} = 0\text{ V}, V_{BIAS} = 3.3\text{ V}$	$V_{IN} = 3.3\text{ V}$	$-40^{\circ}\text{C}$ to $85^{\circ}\text{C}$	0.1	3	$\mu\text{A}$	
				$-40^{\circ}\text{C}$ to $105^{\circ}\text{C}$				4
			$V_{IN} = 1.8\text{ V}$	$-40^{\circ}\text{C}$ to $85^{\circ}\text{C}$	0.07	2		
				$-40^{\circ}\text{C}$ to $105^{\circ}\text{C}$				3
			$V_{IN} = 1.2\text{ V}$	$-40^{\circ}\text{C}$ to $85^{\circ}\text{C}$	0.05	1		
				$-40^{\circ}\text{C}$ to $105^{\circ}\text{C}$				2
$V_{IN} = 0.6\text{ V}$	$-40^{\circ}\text{C}$ to $85^{\circ}\text{C}$	0.04	1					
	$-40^{\circ}\text{C}$ to $105^{\circ}\text{C}$			2				
$I_{ON}$	ON pin input leakage current	$V_{ON} = 5.5\text{ V}, V_{BIAS} = 3.3\text{ V}$	$-40^{\circ}\text{C}$ to $105^{\circ}\text{C}$			0.1	$\mu\text{A}$	
<b>RESISTANCE CHARACTERISTICS</b>								
$R_{ON}$	ON-state resistance	$I_{OUT} = -200\text{ mA}, V_{BIAS} = 3.3\text{ V}$	$V_{IN} = 3.3\text{ V}$	$25^{\circ}\text{C}$	14	18	$\text{m}\Omega$	
				$-40^{\circ}\text{C}$ to $85^{\circ}\text{C}$				20
				$-40^{\circ}\text{C}$ to $105^{\circ}\text{C}$				24
			$V_{IN} = 2.5\text{ V}$	$25^{\circ}\text{C}$	13	17	$\text{m}\Omega$	
				$-40^{\circ}\text{C}$ to $85^{\circ}\text{C}$				20
				$-40^{\circ}\text{C}$ to $105^{\circ}\text{C}$				23
			$V_{IN} = 1.8\text{ V}$	$25^{\circ}\text{C}$	13	17	$\text{m}\Omega$	
				$-40^{\circ}\text{C}$ to $85^{\circ}\text{C}$				20
				$-40^{\circ}\text{C}$ to $105^{\circ}\text{C}$				23
			$V_{IN} = 1.5\text{ V}$	$25^{\circ}\text{C}$	13	17	$\text{m}\Omega$	
				$-40^{\circ}\text{C}$ to $85^{\circ}\text{C}$				20
				$-40^{\circ}\text{C}$ to $105^{\circ}\text{C}$				23
			$V_{IN} = 1.2\text{ V}$	$25^{\circ}\text{C}$	13	17	$\text{m}\Omega$	
				$-40^{\circ}\text{C}$ to $85^{\circ}\text{C}$				20
				$-40^{\circ}\text{C}$ to $105^{\circ}\text{C}$				23
			$V_{IN} = 0.6\text{ V}$	$25^{\circ}\text{C}$	13	17	$\text{m}\Omega$	
				$-40^{\circ}\text{C}$ to $85^{\circ}\text{C}$				20
				$-40^{\circ}\text{C}$ to $105^{\circ}\text{C}$				23
$R_{PD}$	Output pulldown resistance	$V_{IN} = V_{BIAS} = 3.3\text{ V}, V_{ON} = 0\text{ V}, I_{OUT} = 10\text{ mA}$	$-40^{\circ}\text{C}$ to $105^{\circ}\text{C}$	135	160		$\Omega$	

## 7.7 Electrical Characteristics ( $V_{BIAS} = 2.5\text{ V}$ )

Unless otherwise noted, the specification in the following table applies over the operating ambient temperature  $-40\text{ }^{\circ}\text{C} \leq T_A \leq 105\text{ }^{\circ}\text{C}$  and  $V_{BIAS} = 2.5\text{ V}$ . Typical values are for  $T_A = 25\text{ }^{\circ}\text{C}$  (unless otherwise noted).

PARAMETER		TEST CONDITIONS	$T_A$	MIN	TYP	MAX	UNIT	
<b>POWER SUPPLIES AND CURRENTS</b>								
$I_Q, V_{BIAS}$	$V_{BIAS}$ quiescent current	$I_{OUT} = 0, V_{IN} = V_{ON} = V_{BIAS} = 2.5\text{ V}$	-40°C to 85°C	14	17		$\mu\text{A}$	
			-40°C to 105°C			17		
$I_{SD}, V_{BIAS}$	$V_{BIAS}$ shutdown current	$V_{ON} = 0\text{ V}, V_{OUT} = 0\text{ V}, V_{BIAS} = 2.5\text{ V}$	-40°C to 85°C	0.2	0.5		$\mu\text{A}$	
			-40°C to 105°C			0.5		
$I_{SD}, V_{IN}$	$V_{IN}$ shutdown current (per channel)	$V_{ON} = 0\text{ V}, V_{OUT} = 0\text{ V}, V_{BIAS} = 2.5\text{ V}$	$V_{IN} = 2.5\text{ V}$	-40°C to 85°C	0.1	3	$\mu\text{A}$	
				-40°C to 105°C				4
			$V_{IN} = 1.8\text{ V}$	-40°C to 85°C	0.07	2		
				-40°C to 105°C				3
			$V_{IN} = 1.2\text{ V}$	-40°C to 85°C	0.05	1		
				-40°C to 105°C				2
$V_{IN} = 0.6\text{ V}$	-40°C to 85°C	0.04	1					
	-40°C to 105°C			2				
$I_{ON}$	ON pin input leakage current	$V_{ON} = 5.5\text{ V}, V_{BIAS} = 2.5\text{ V}$	-40°C to 105°C			0.1	$\mu\text{A}$	
<b>RESISTANCE CHARACTERISTICS</b>								
$R_{ON}$	ON-state resistance	$I_{OUT} = -200\text{ mA}, V_{BIAS} = 2.5\text{ V}$	$V_{IN} = 2.5\text{ V}$	25°C	15	19	$\text{m}\Omega$	
				-40°C to 85°C				23
				-40°C to 105°C				26
			$V_{IN} = 1.8\text{ V}$	25°C	14	18	$\text{m}\Omega$	
				-40°C to 85°C				22
				-40°C to 105°C				25
			$V_{IN} = 1.5\text{ V}$	25°C	14	18	$\text{m}\Omega$	
				-40°C to 85°C				22
				-40°C to 105°C				25
			$V_{IN} = 1.2\text{ V}$	25°C	14	18	$\text{m}\Omega$	
				-40°C to 85°C				22
				-40°C to 105°C				25
$V_{IN} = 0.6\text{ V}$	25°C	13	18	$\text{m}\Omega$				
	-40°C to 85°C				22			
	-40°C to 105°C				25			
$R_{PD}$	Output pulldown resistance	$V_{IN} = V_{BIAS} = 2.5\text{ V}, V_{ON} = 0\text{ V}, I_{OUT} = 10\text{ mA}$	-40°C to 105°C	135	160		$\Omega$	



## 7.8 Switching Characteristics

PARAMETER		TEST CONDITION	MIN	TYP	MAX	UNIT
<b><math>V_{IN} = V_{ON} = V_{BIAS} = 5\text{ V}</math>, <math>T_A = 25\text{ }^\circ\text{C}</math></b>						
$t_{ON}$	Turn-on time	$R_L = 10\ \Omega$ , $C_L = 0.1\ \mu\text{F}$ , $CT = 1000\ \text{pF}$		646		$\mu\text{s}$
$t_{OFF}$	Turn-off time	$R_L = 10\ \Omega$ , $C_L = 0.1\ \mu\text{F}$ , $CT = 1000\ \text{pF}$		5		
$t_R$	$V_{OUT}$ rise time	$R_L = 10\ \Omega$ , $C_L = 0.1\ \mu\text{F}$ , $CT = 1000\ \text{pF}$		769		
$t_F$	$V_{OUT}$ fall time	$R_L = 10\ \Omega$ , $C_L = 0.1\ \mu\text{F}$ , $CT = 1000\ \text{pF}$		2		
$t_D$	ON delay time	$R_L = 10\ \Omega$ , $C_L = 0.1\ \mu\text{F}$ , $CT = 1000\ \text{pF}$		280		
<b><math>V_{IN} = 0.6\ \text{V}</math>, <math>V_{ON} = V_{BIAS} = 5\ \text{V}</math>, <math>T_A = 25\text{ }^\circ\text{C}</math></b>						
$t_{ON}$	Turn-on time	$R_L = 10\ \Omega$ , $C_L = 0.1\ \mu\text{F}$ , $CT = 1000\ \text{pF}$		303		$\mu\text{s}$
$t_{OFF}$	Turn-off time	$R_L = 10\ \Omega$ , $C_L = 0.1\ \mu\text{F}$ , $CT = 1000\ \text{pF}$		91		
$t_R$	$V_{OUT}$ rise time	$R_L = 10\ \Omega$ , $C_L = 0.1\ \mu\text{F}$ , $CT = 1000\ \text{pF}$		126		
$t_F$	$V_{OUT}$ fall time	$R_L = 10\ \Omega$ , $C_L = 0.1\ \mu\text{F}$ , $CT = 1000\ \text{pF}$		7		
$t_D$	ON delay time	$R_L = 10\ \Omega$ , $C_L = 0.1\ \mu\text{F}$ , $CT = 1000\ \text{pF}$		243		
<b><math>V_{IN} = 2.5\ \text{V}</math>, <math>V_{ON} = 5\ \text{V}</math>, <math>V_{BIAS} = 2.5\ \text{V}</math>, <math>T_A = 25\text{ }^\circ\text{C}</math></b>						
$t_{ON}$	Turn-on time	$R_L = 10\ \Omega$ , $C_L = 0.1\ \mu\text{F}$ , $CT = 1000\ \text{pF}$		983		$\mu\text{s}$
$t_{OFF}$	Turn-off time	$R_L = 10\ \Omega$ , $C_L = 0.1\ \mu\text{F}$ , $CT = 1000\ \text{pF}$		7		
$t_R$	$V_{OUT}$ rise time	$R_L = 10\ \Omega$ , $C_L = 0.1\ \mu\text{F}$ , $CT = 1000\ \text{pF}$		987		
$t_F$	$V_{OUT}$ fall time	$R_L = 10\ \Omega$ , $C_L = 0.1\ \mu\text{F}$ , $CT = 1000\ \text{pF}$		2		
$t_D$	ON delay time	$R_L = 10\ \Omega$ , $C_L = 0.1\ \mu\text{F}$ , $CT = 1000\ \text{pF}$		518		
<b><math>V_{IN} = 0.6\ \text{V}</math>, <math>V_{ON} = 5\ \text{V}</math>, <math>V_{BIAS} = 2.5\ \text{V}</math>, <math>T_A = 25\text{ }^\circ\text{C}</math></b>						
$t_{ON}$	Turn-on time	$R_L = 10\ \Omega$ , $C_L = 0.1\ \mu\text{F}$ , $CT = 1000\ \text{pF}$		611		$\mu\text{s}$
$t_{OFF}$	Turn-off time	$R_L = 10\ \Omega$ , $C_L = 0.1\ \mu\text{F}$ , $CT = 1000\ \text{pF}$		77		
$t_R$	$V_{OUT}$ rise time	$R_L = 10\ \Omega$ , $C_L = 0.1\ \mu\text{F}$ , $CT = 1000\ \text{pF}$		305		
$t_F$	$V_{OUT}$ fall time	$R_L = 10\ \Omega$ , $C_L = 0.1\ \mu\text{F}$ , $CT = 1000\ \text{pF}$		7		
$t_D$	ON delay time	$R_L = 10\ \Omega$ , $C_L = 0.1\ \mu\text{F}$ , $CT = 1000\ \text{pF}$		468		

## 7.9 Typical DC Characteristics

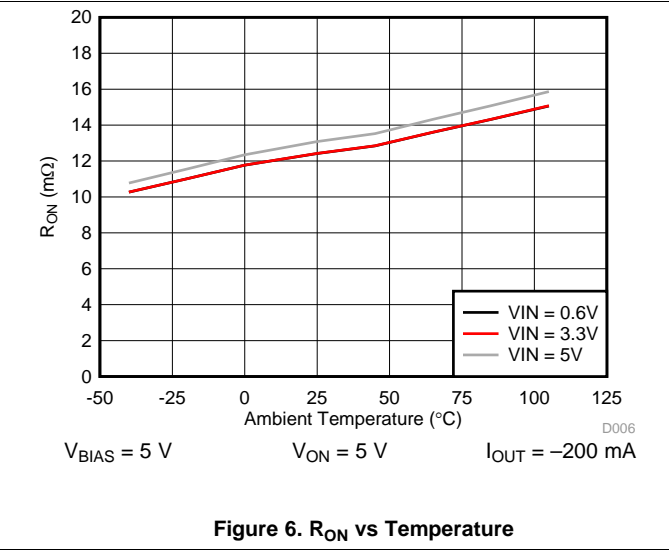
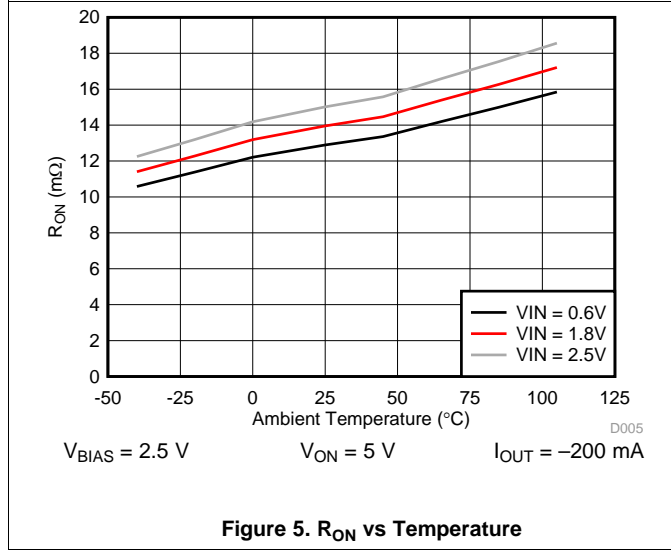
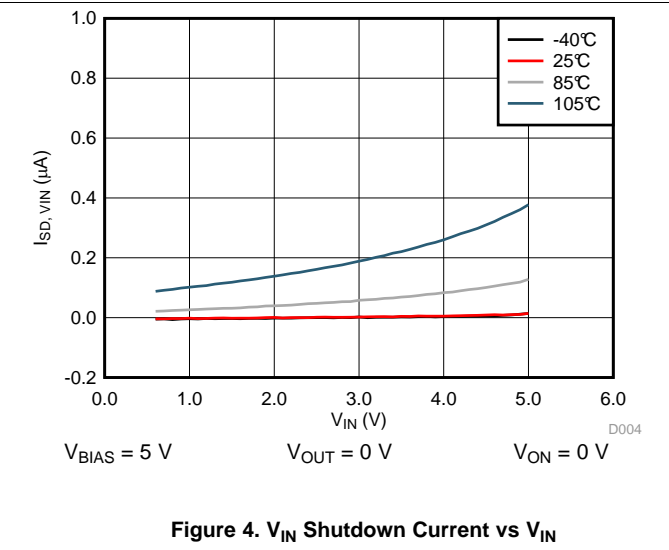
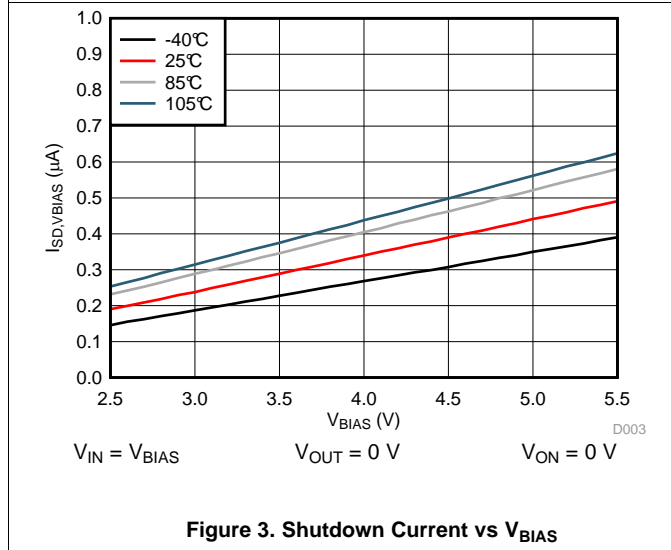
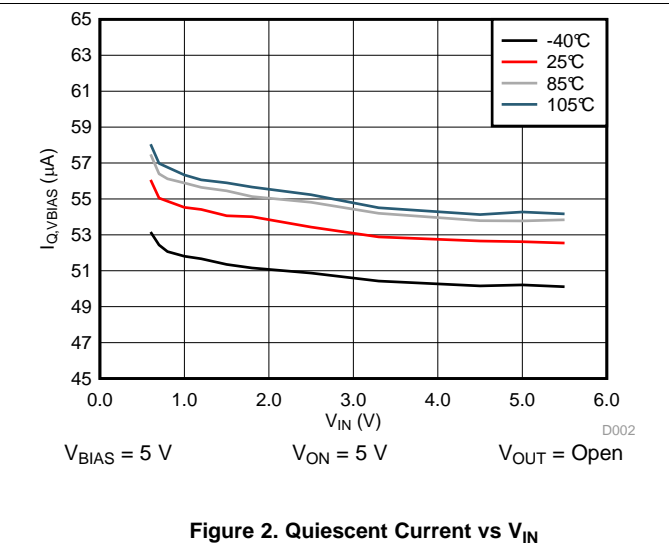
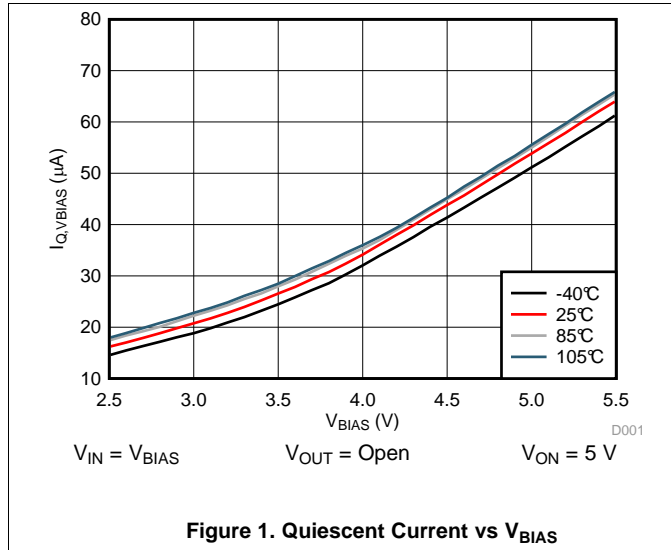

Typical DC Characteristics (continued)

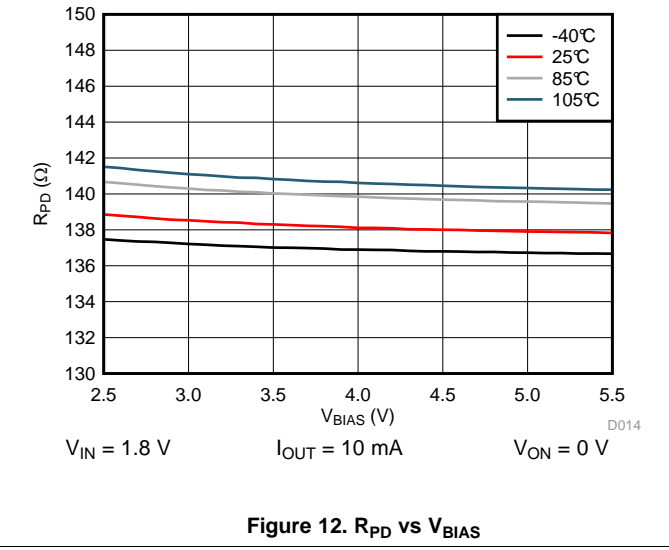
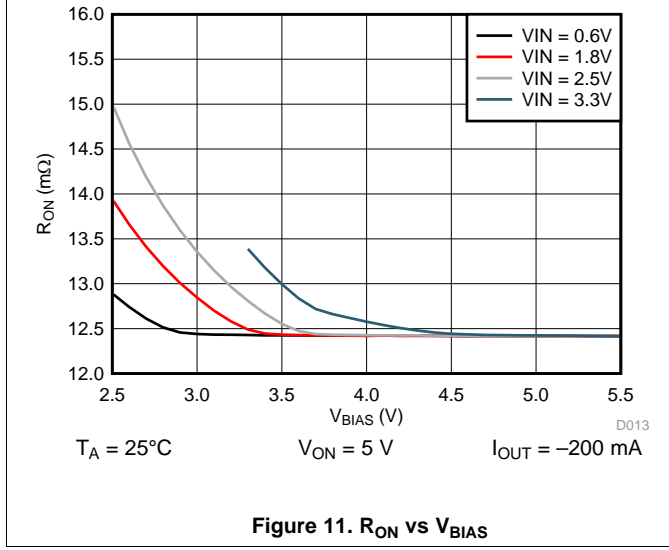
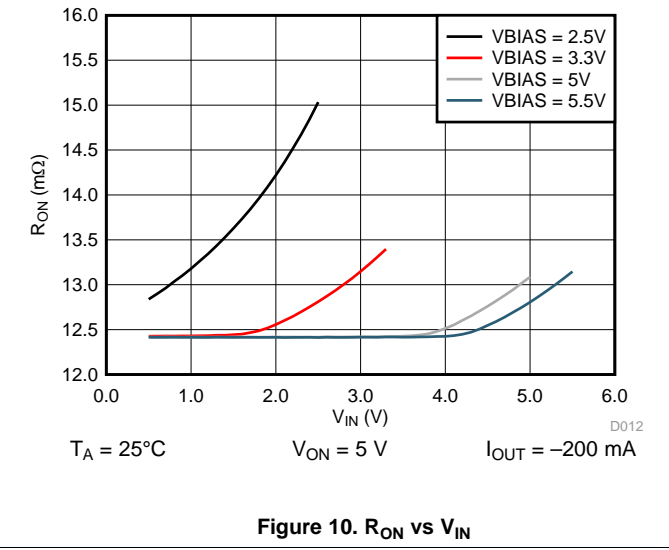
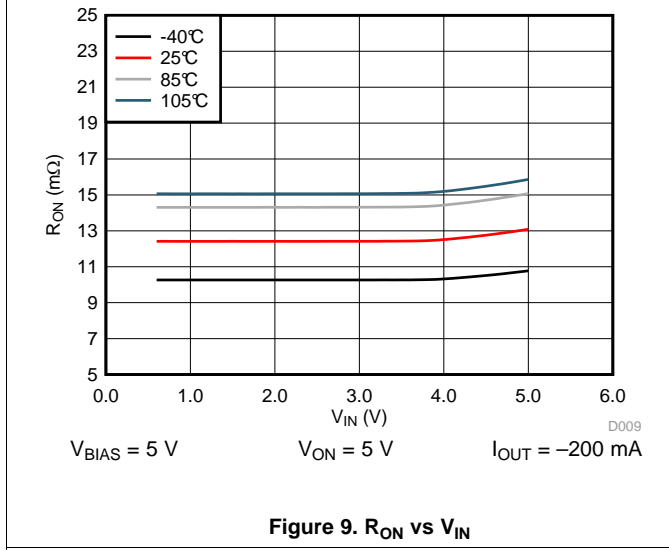
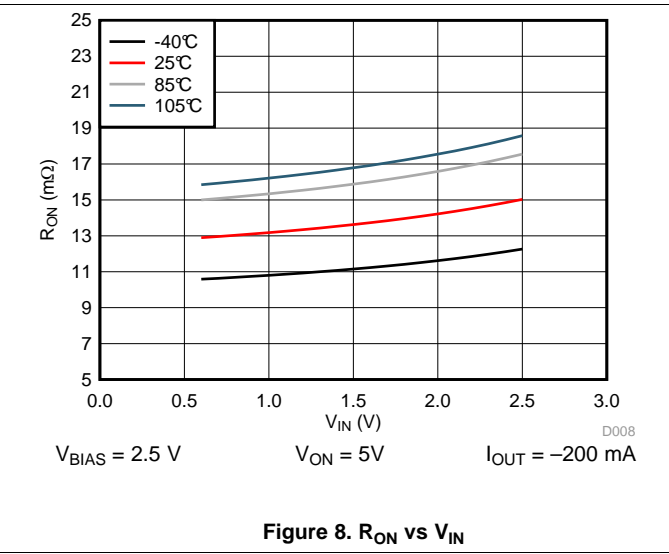
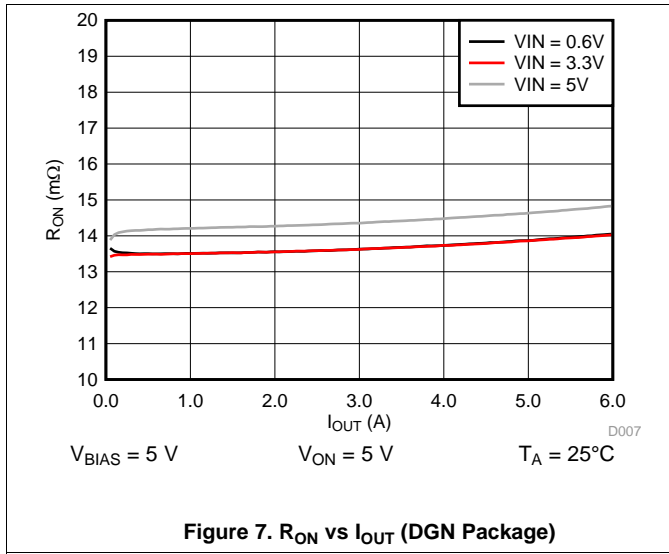

**Typical DC Characteristics (continued)**

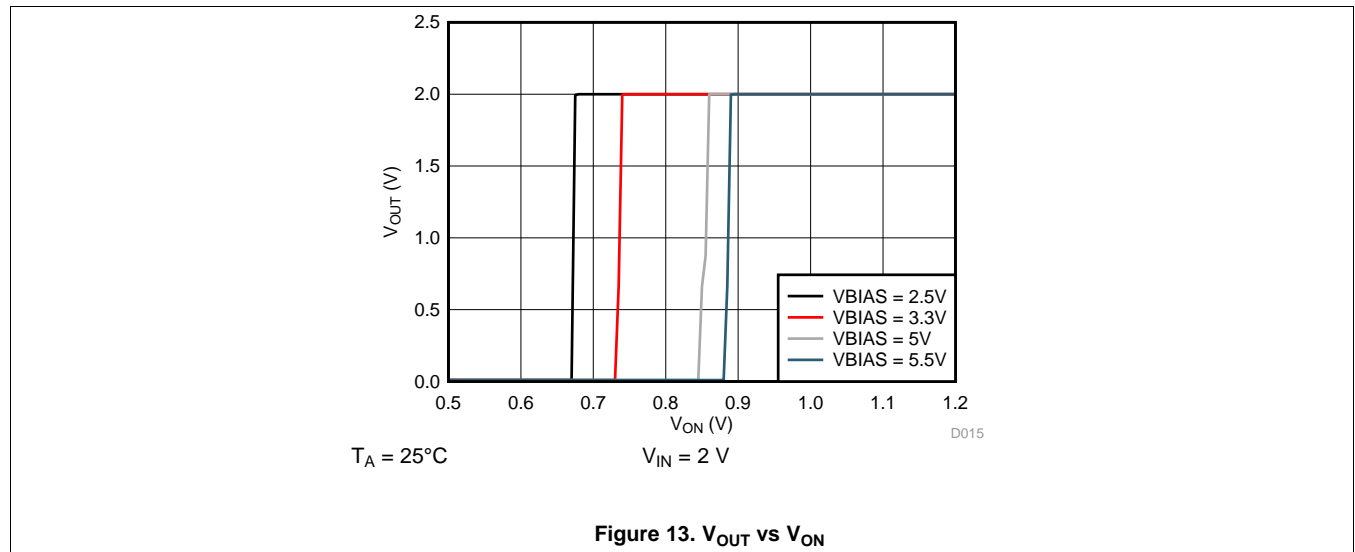

### 7.10 Typical AC Characteristics

$C_{IN} = 1 \mu F$ ,  $C_L = 0.1 \mu F$ ,  $R_L = 10 \Omega$  (unless otherwise specified)

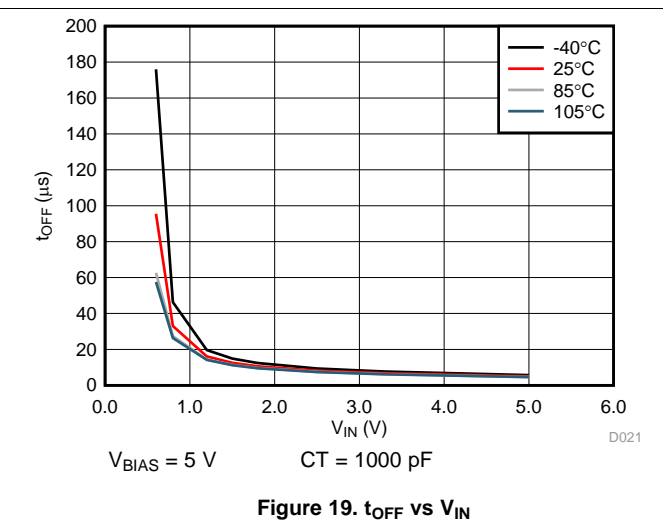
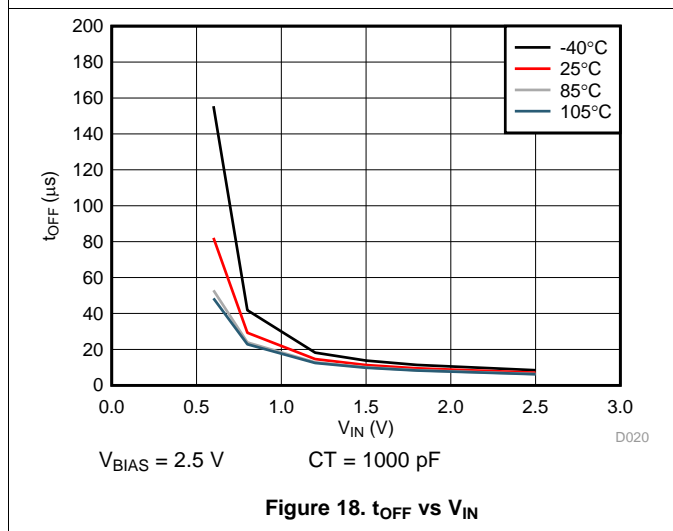
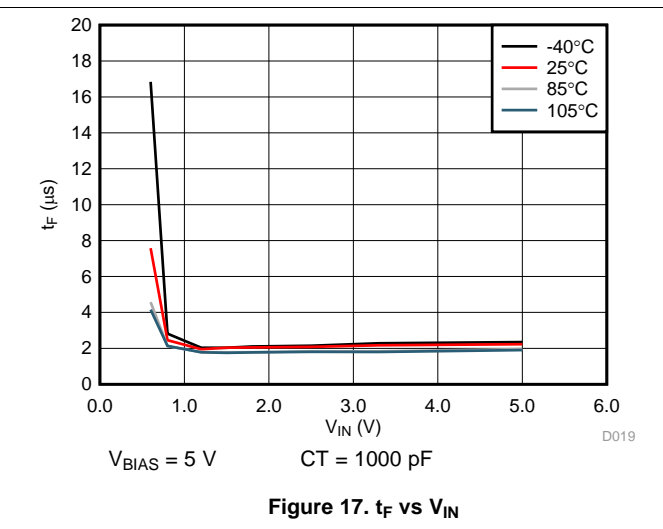
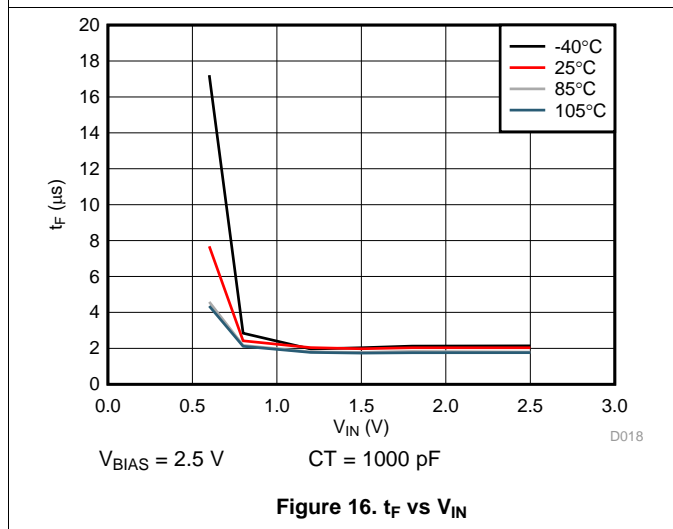
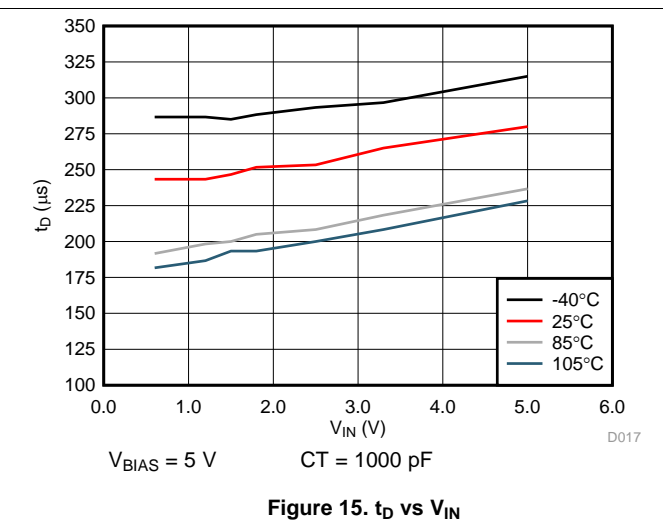
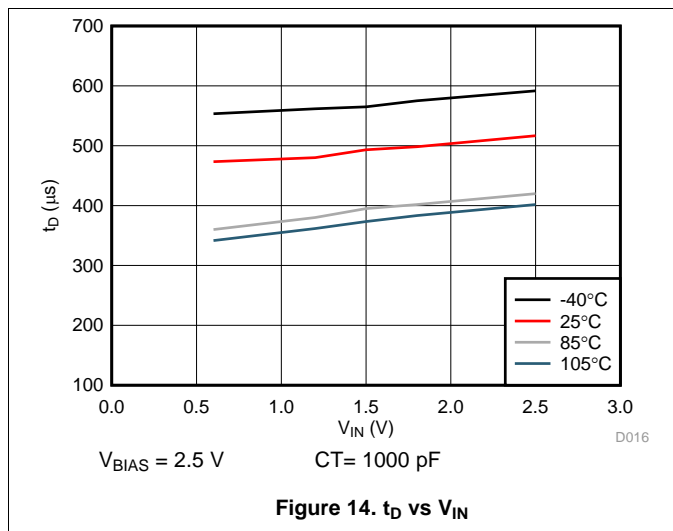

Typical AC Characteristics (continued)

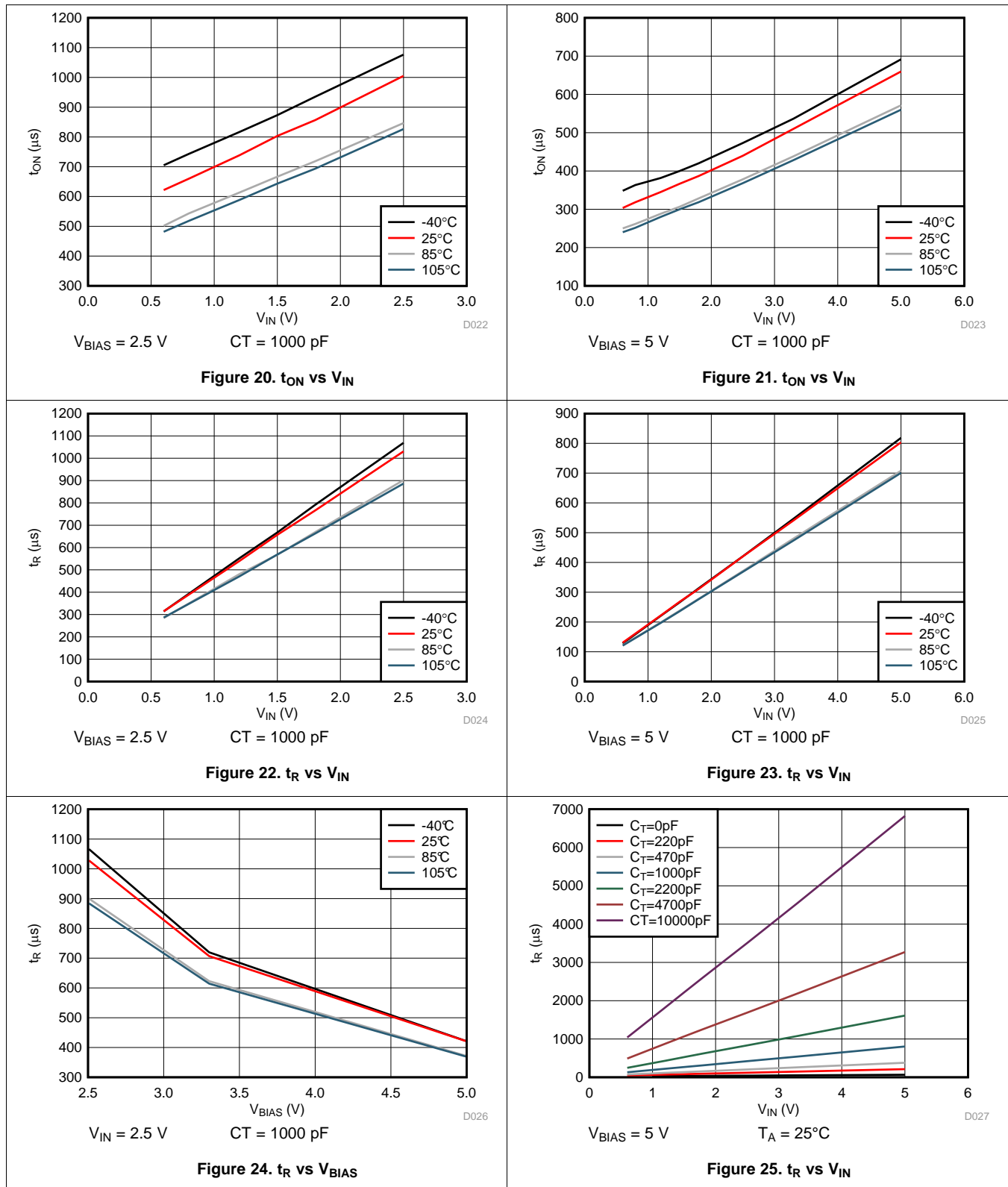

Typical AC Characteristics (continued)

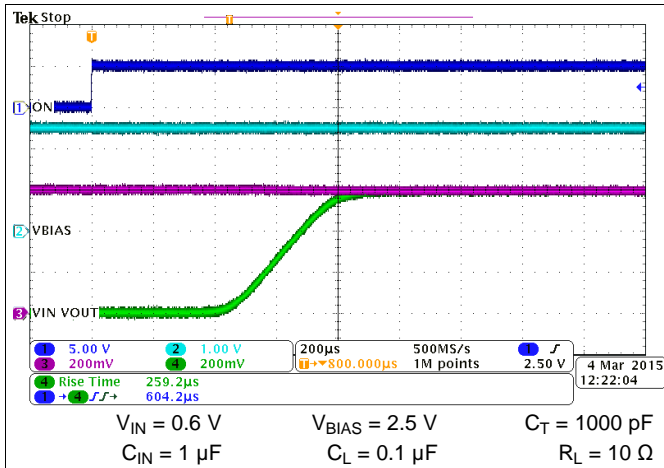

Figure 26. Turn-on Response Time

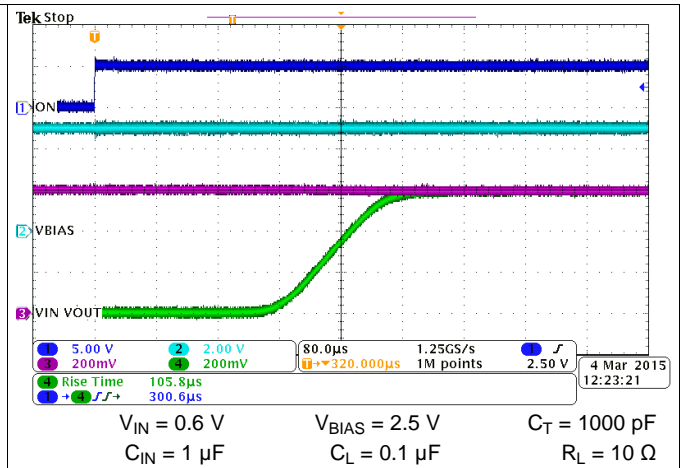

Figure 27. Turn-on Response Time

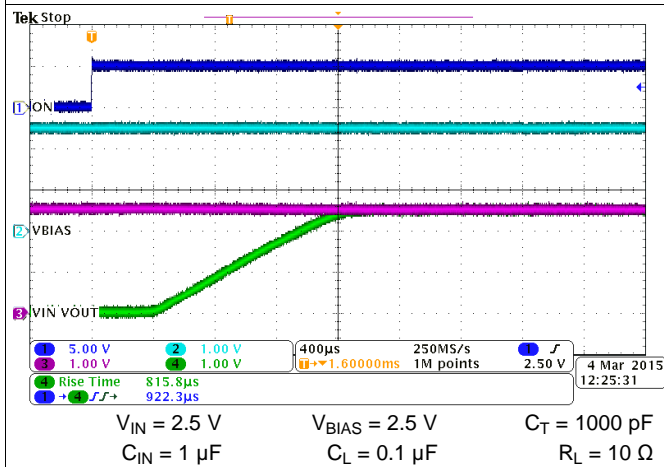

Figure 28. Turn-on Response Time

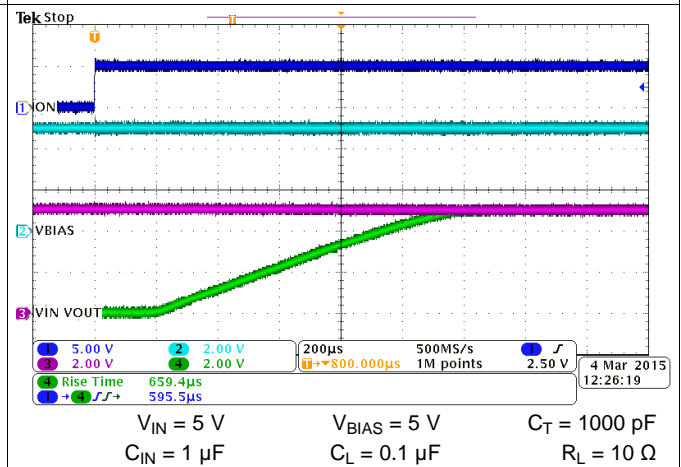

Figure 29. Turn-on Response Time

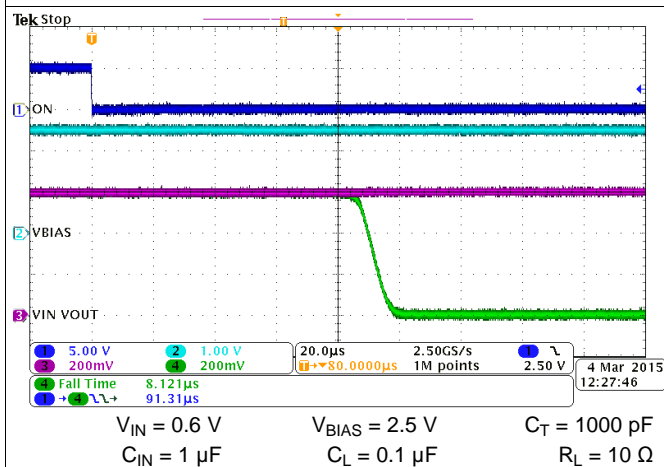

Figure 30. Turn-Off Response Time

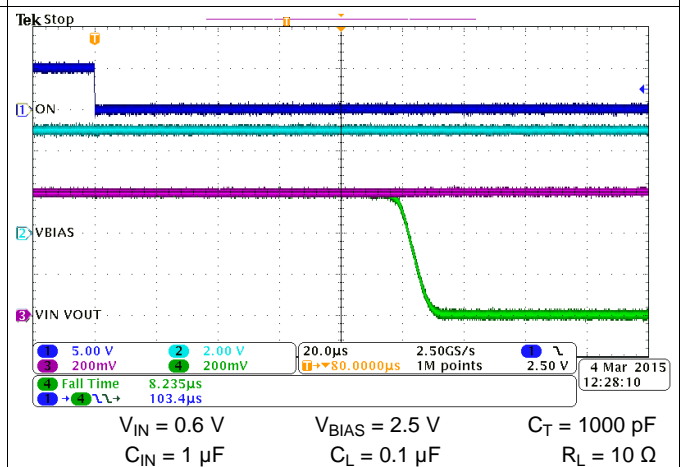
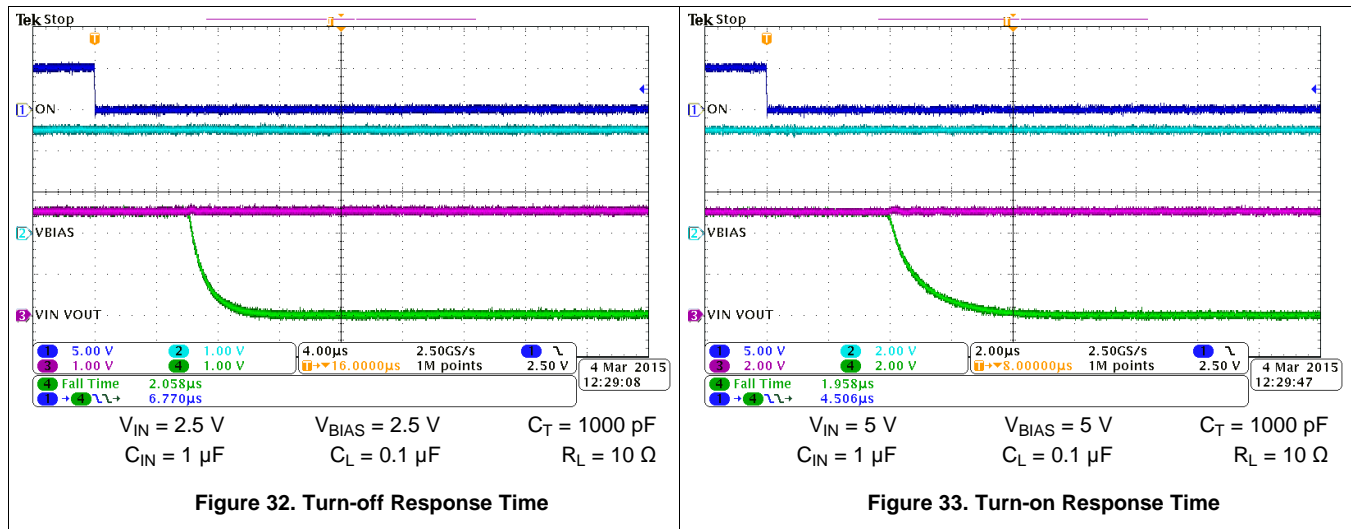
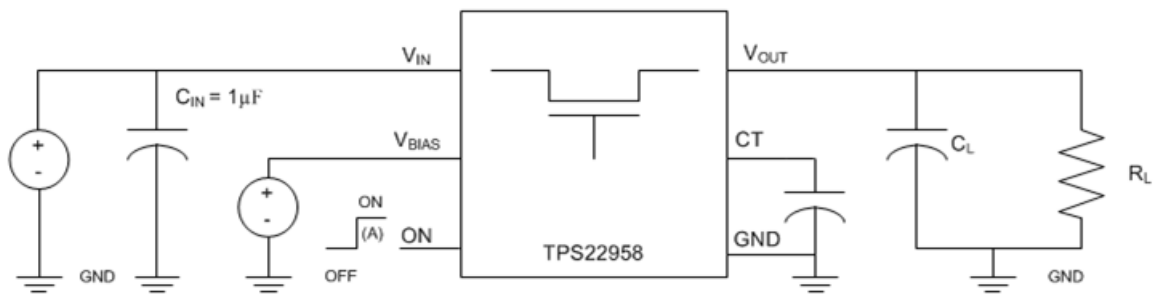

Figure 31. Turn-off Response Time

Typical AC Characteristics (continued)



8 Parameter Measurement Information



Timing test circuit

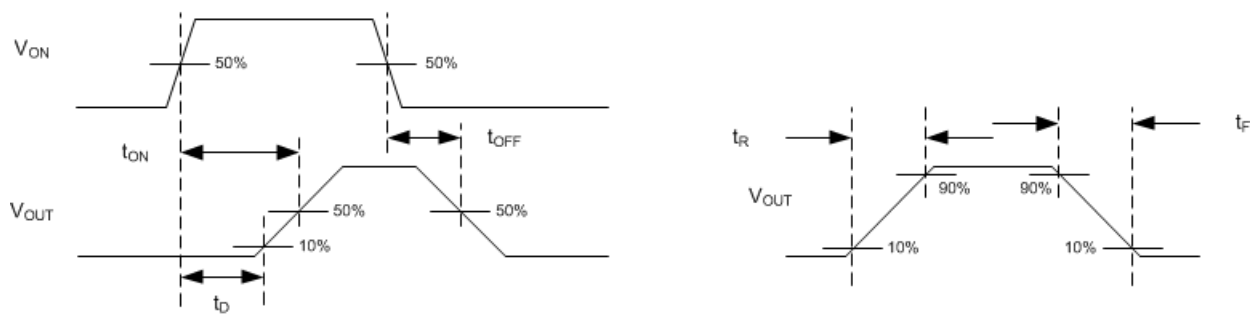

Timing waveforms

(A) Rise and fall times of the control signal is 100ns.

Figure 34. Test Circuit and Timing Waveforms



## 9 Detailed Description

### 9.1 Overview

This device is a 5.5 V, 4 A / 6 A, single channel load switch with an adjustable rise time. The device contains an N-channel MOSFET controlled by an on/off GPIO-compatible input. The ON pin must be connected and cannot be left floating. The device is designed to control the turn-on rate and therefore the inrush current. By controlling the inrush current, power supply sag can be reduced during turn on. The slew rate is set by connecting a capacitor from the CT pin to GND.

The slew rate is proportional to the capacitor on the CT pin. Refer to the [Adjustable Rise Time](#) section to determine the correct CT value for a desired rise time.

The internal circuitry is powered by the VBIAS pin, which supports voltages from 2.5 to 5.5 V. This circuitry includes the charge pump, QOD, and control logic. For these internal blocks to function correctly, a voltage between 2.5 and 5.5 V must be supplied to VBIAS.

When a voltage is supplied to VBIAS and the ON pin goes low, the QOD turns on. This connects VOUT to GND through an on-chip resistor and is not a feature for the TPS22958N. The typical pull-down resistance ( $R_{PD}$ ) is 135  $\Omega$ .

### 9.2 Functional Block Diagram

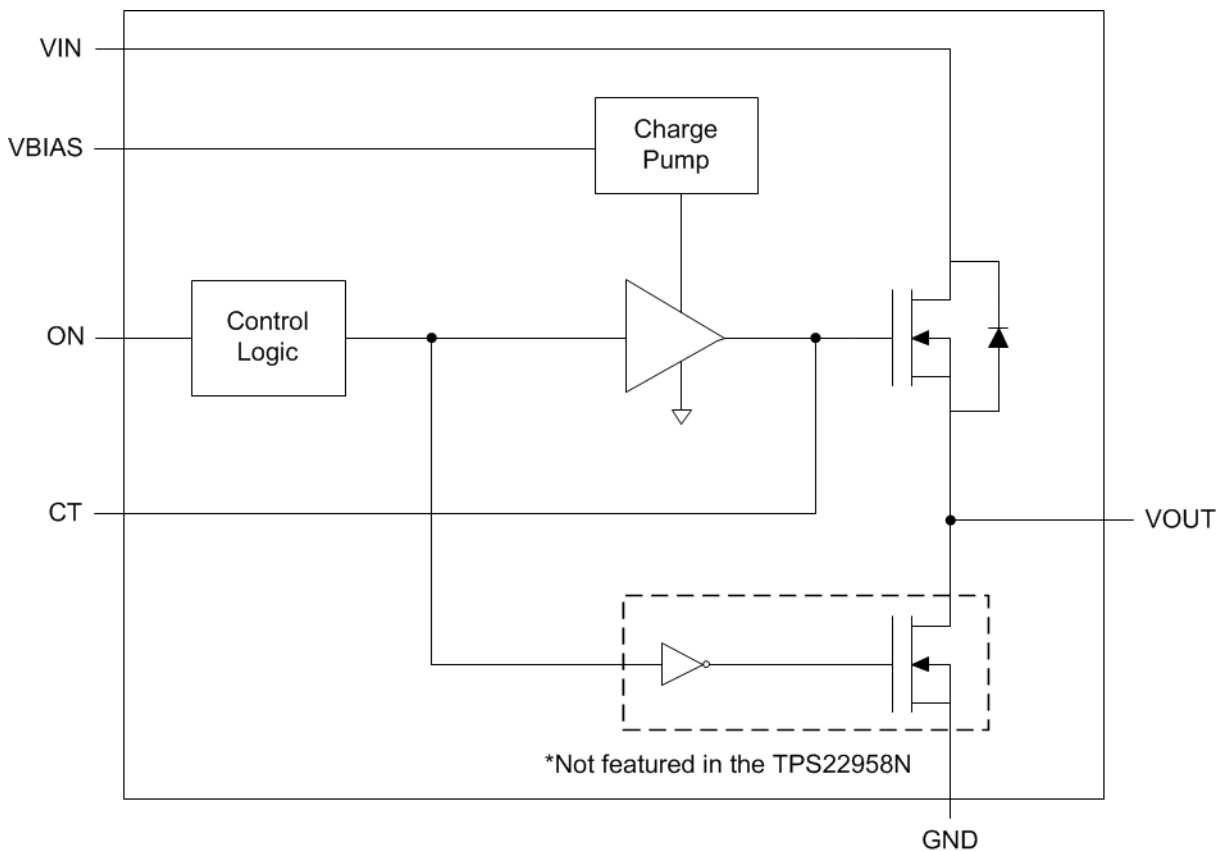

### 9.3 Feature Description

#### 9.3.1 ON/OFF Control

The ON pin controls the state of the switch. Asserting ON high enables the switch. ON is active high and has a low threshold, making it capable of interfacing with low-voltage signals. The ON pin is compatible with standard GPIO logic threshold. It can be used with any microcontroller with 1.2 V or higher GPIO voltage. This pin cannot be left floating and must be tied either high or low for proper functionality.

## Feature Description (continued)

### 9.3.2 Quick Output Discharge (QOD)

The TPS22958 includes a QOD feature while the TPS22958N does not. When the device is disabled, a discharge resistor is connected between VOUT and GND. This resistor has a typical value of 135  $\Omega$  and prevents the output from floating while the switch is disabled.

### 9.3.3 VIN and VBIAS Voltage Range

For optimal  $R_{ON}$  performance, make sure  $V_{IN} \leq V_{BIAS}$ . The device will still function if  $V_{IN} > V_{BIAS}$  but will exhibit an  $R_{ON}$  greater than what is listed in the Electrical Characteristics table. See [Figure 35](#) for an example of a typical device.  $R_{ON}$  increases as  $V_{IN}$  exceeds the  $V_{BIAS}$  voltage. For the maximum voltage ratings on the VIN and VBIAS pins, please refer to the [Absolute Maximum Ratings](#) table.

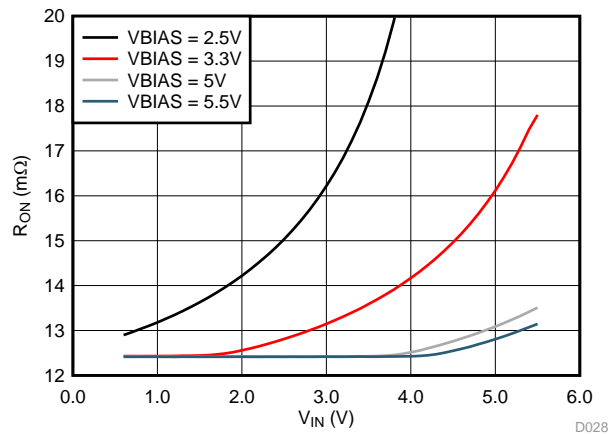

$T_A = 25^\circ\text{C}$      $I_{OUT} = -200 \text{ mA}$      $V_{ON} = 5 \text{ V}$

**Figure 35.  $R_{ON}$  vs  $V_{IN}$**

## Feature Description (continued)

### 9.3.4 Adjustable Rise Time

A capacitor from the CT pin to GND sets the slew rate, and it should be rated for 25 V and above. An approximate formula for the relationship between CT and slew rate with  $V_{BIAS} = 5\text{ V}$  is:

$$SR = 0.146 \times CT + 14.78$$

where

- SR = slew rate (in  $\mu\text{s/V}$ )
- CT = the capacitance value on the CT pin (in pF)
- The units for the constant 14.78 is  $\mu\text{s/V}$ .
- The units for the constant 0.146 is  $\mu\text{s}/(\text{V}\times\text{pF})$  (1)

Rise time can be calculated by multiplying the input voltage by the slew rate. [Table 1](#) contains rise time values measured on a typical device.

**Table 1. Rise Time Table**

CTx (pF)	RISE TIME ( $\mu\text{s}$ ) 10% - 90%, $C_L = 0.1\ \mu\text{F}$ , $C_{IN} = 1\ \mu\text{F}$ , $R_L = 10\ \Omega$ , $V_{BIAS} = 5\ \text{V}$ Typical values at 25°C with a 25-V X7R 10% ceramic capacitor on CT						
	VIN = 5 V	VIN = 3.3 V	VIN = 1.8 V	VIN = 1.5 V	VIN = 1.2 V	VIN = 0.8 V	VIN = 0.6 V
0	79	59	41	37	33	26	23
220	227	158	97	86	74	55	48
470	397	270	160	139	116	88	72
1000	769	522	301	258	211	153	126
2200	1659	1118	640	548	450	315	256
4700	3445	2314	1315	1128	927	656	528
10000	7310	4884	2778	2372	1950	1379	1103

## 9.4 Device Functional Modes

The following table lists the VOUT pin connections for a particular device as determined by the ON pin.

**Table 2. VOUT Functional Table**

ON (Control Input)	TPS22958	TPS22958N
L	GND	Open
H	VIN	VIN

## 10 Application and Implementation

### 10.1 Application Information

#### 10.1.1 Input Capacitor (Optional)

To limit the voltage drop on the input supply caused by transient inrush currents when the switch turns on into a discharged load capacitor, a capacitor can be placed between VIN and GND. A 1  $\mu\text{F}$  ceramic capacitor,  $C_{\text{IN}}$ , placed close to the pins, is usually sufficient. Higher values of  $C_{\text{IN}}$  can be used to further reduce the voltage drop during high-current application. When switching heavy loads, TI recommends to have an input capacitor about 10x higher than the output capacitor to avoid excessive voltage drop.

#### 10.1.2 Output Capacitor (Optional)

Due to the integrated body diode in the NMOS switch, TI recommends a  $C_{\text{IN}}$  greater than  $C_{\text{L}}$ . A  $C_{\text{L}}$  greater than  $C_{\text{IN}}$  can cause the voltage on VOUT to exceed VIN when the system supply is removed. This could result in current flow through the body diode from VOUT to VIN. TI recommends a  $C_{\text{IN}}$  to  $C_{\text{L}}$  ratio of 10 to 1 for minimizing  $V_{\text{IN}}$  dip caused by inrush currents during startup.

#### 10.1.3 Power Supply Sequencing Without a GPIO Input

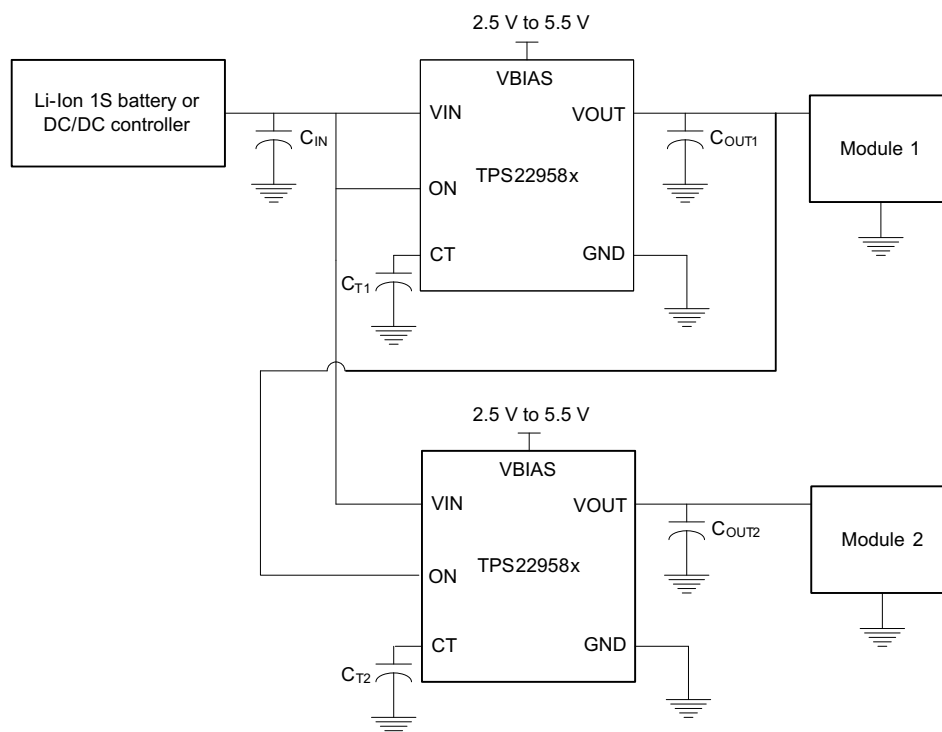

**Figure 36. Power Supply Sequencing Without a GPIO Input**

In many end equipments, there is a need to power up various modules in a pre-determined manner. The TPS22958x can solve the problem of power sequencing without adding any complexity to the overall system. [Figure 36](#) shows the configuration required for powering up two modules in a fixed sequence. The output of the first load switch is tied to the enable of the second load switch, so when Module 1 is powered the second load switch is enabled and Module 2 is powered.

## 10.2 Typical Application

This application demonstrates how the TPS22958 can be used to power a downstream load with a large capacitance. The example in Figure 37 is powering a 22  $\mu\text{F}$  capacitive output load.

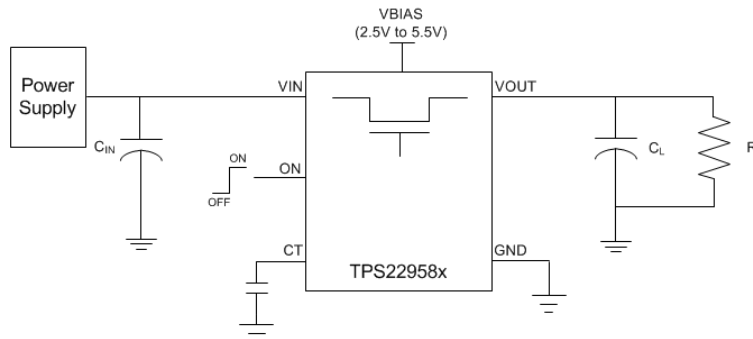

Figure 37. Typical Application Schematic

### 10.2.1 Design Requirements

For this design example, use the following as the input parameters.

Table 3. Design Parameters

DESIGN PARAMETER	EXAMPLE VALUE
$V_{IN}$	3.3 V
$V_{BIAS}$	5.0 V
Load current	4 A
Output capacitance ( $C_L$ )	22 $\mu\text{F}$
Allowable inrush current on VOUT	0.33 A

### 10.2.2 Detailed Design Procedure

To begin the design process, the designer needs to know the following:

- $V_{IN}$  voltage
- $V_{BIAS}$  voltage
- Load current
- Allowable inrush current on VOUT due to  $C_L$  capacitor

#### 10.2.2.1 $V_{IN}$ to $V_{OUT}$ Voltage Drop

The  $V_{IN}$  to  $V_{OUT}$  voltage drop in the device is determined by the  $R_{ON}$  of the device and the load current. The  $R_{ON}$  of the device depends upon the  $V_{IN}$  and  $V_{BIAS}$  conditions of the device. Refer to the  $R_{ON}$  specification of the device in the Electrical Characteristics table. After the  $R_{ON}$  of the device is determined based upon the  $V_{IN}$  and  $V_{BIAS}$  conditions, use Equation 2 to calculate the  $V_{IN}$  to  $V_{OUT}$  voltage drop:

$$\Delta V = I_{LOAD} \times R_{ON}$$

where

- $\Delta V$  = voltage drop from  $V_{IN}$  to  $V_{OUT}$
- $I_{LOAD}$  = load current
- $R_{ON}$  = On-resistance of the device for a specific  $V_{IN}$  and  $V_{BIAS}$  combination

(2)

An appropriate  $I_{LOAD}$  must be chosen such that the  $I_{MAX}$  specification of the device is not violated.

### 10.2.2.2 Inrush Current

To determine how much inrush current will be caused by the  $C_L$  capacitor, use [Equation 3](#).

$$I_{\text{INRUSH}} = C_L \times \frac{dV_{\text{OUT}}}{dt}$$

where

- $I_{\text{INRUSH}}$  = amount of inrush caused by  $C_L$
- $C_L$  = capacitance on VOUT
- $dt$  = time it takes for change in  $V_{\text{OUT}}$  during the ramp up of VOUT when the device is enabled
- $dV_{\text{OUT}}$  = change in  $V_{\text{OUT}}$  during the ramp up of VOUT when the device is enabled (3)

The device offers adjustable rise time for VOUT and allows the user to control the inrush current during turn-on through the CT pin. The appropriate rise time can be calculated using the design requirements and the inrush current equation ([Equation 3](#)).

$$330 \text{ mA} = 22 \text{ } \mu\text{F} \times 3.3 \text{ V} / dt \quad (4)$$

$$dt = 22 \text{ } \mu\text{F} \times 3.3 \text{ V} / 300\text{mA} \quad (5)$$

$$dt = 220 \text{ } \mu\text{s} \quad (6)$$

To ensure an inrush current of less than 330 mA, choose a CT based on [Table 1](#) or [Equation 1](#) value that will yield a rise time of more than 220  $\mu\text{s}$ . See the oscilloscope captures in the [Application Curves](#) for an example of how the CT capacitor can be used to reduce inrush current. See [Table 1](#) for correlation between rise times and CT values.

An appropriate  $C_L$  value should be placed on VOUT such that the  $I_{\text{MAX}}$  and  $I_{\text{PLS}}$  specifications of the device are not violated.

### 10.2.2.3 Thermal Considerations

The maximum IC junction temperature should be restricted to 125°C under normal operating conditions. To calculate the maximum allowable dissipation,  $P_{\text{D(max)}}$  for a given output current and ambient temperature, use [Equation 7](#).

$$P_{\text{D(MAX)}} = \frac{T_{\text{J(MAX)}} - T_{\text{A}}}{R_{\theta\text{JA}}}$$

where

- $P_{\text{D(max)}}$  = maximum allowable power dissipation
- $T_{\text{J(max)}}$  = maximum allowable junction temperature (125°C for the TPS22958)
- $T_{\text{A}}$  = ambient temperature of the device
- $R_{\theta\text{JA}}$  = junction to air thermal impedance. See [Thermal Information](#). This parameter is highly dependent upon board layout. (7)

For the DGK package,  $V_{\text{BIAS}} = 5 \text{ V}$ , and  $V_{\text{IN}} = 3.3 \text{ V}$ , the maximum ambient temperature with a 4 A load can be determined by using the following calculation:

$$P_{\text{D}} = I^2 \times R \quad (8)$$

$$T_{\text{A}} = T_{\text{J(MAX)}} - R_{\theta\text{JA}} \times P_{\text{D}} \quad (9)$$

$$T_{\text{A}} = T_{\text{J(MAX)}} - R_{\theta\text{JA}} \times I^2 \times R \quad (10)$$

$$T_{\text{A}} = 125^\circ\text{C} - 185.7^\circ\text{C/W} \times (4 \text{ A})^2 \times 20 \text{ m}\Omega = 65.6^\circ\text{C} \quad (11)$$

Therefore, with the conditions mentioned above, a maximum ambient temperature of 65.6°C is recommended.

For the DGN package,  $V_{BIAS} = 5\text{ V}$ , and  $V_{IN} = 3.3\text{ V}$ , the maximum ambient temperature with a 4 A load can be determined by using the following calculation:

$$P_D = I^2 \times R \tag{12}$$

$$T_A = T_{J(MAX)} - R_{\theta JA} \times P_D \tag{13}$$

$$T_A = T_{J(MAX)} - R_{\theta JA} \times I^2 \times R \tag{14}$$

$$T_A = 125^\circ\text{C} - 67.0^\circ\text{C/W} \times (4\text{ A})^2 \times 20\text{ m}\Omega = 103.6^\circ\text{C} \tag{15}$$

Therefore, with the conditions mentioned above, a maximum ambient temperature of 103.6°C is recommended.

### 10.2.3 Application Curves

The three scope captures show the usage of a CT capacitor in conjunction with the device. A higher CT value results in a slower rise and a lower inrush current.

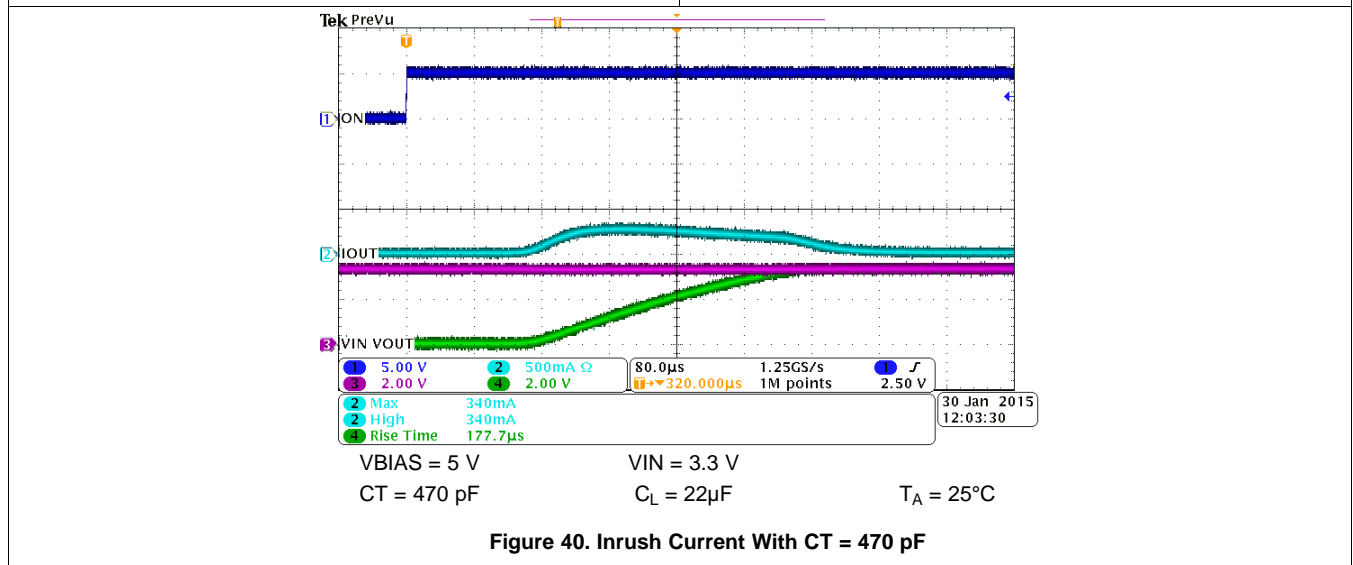
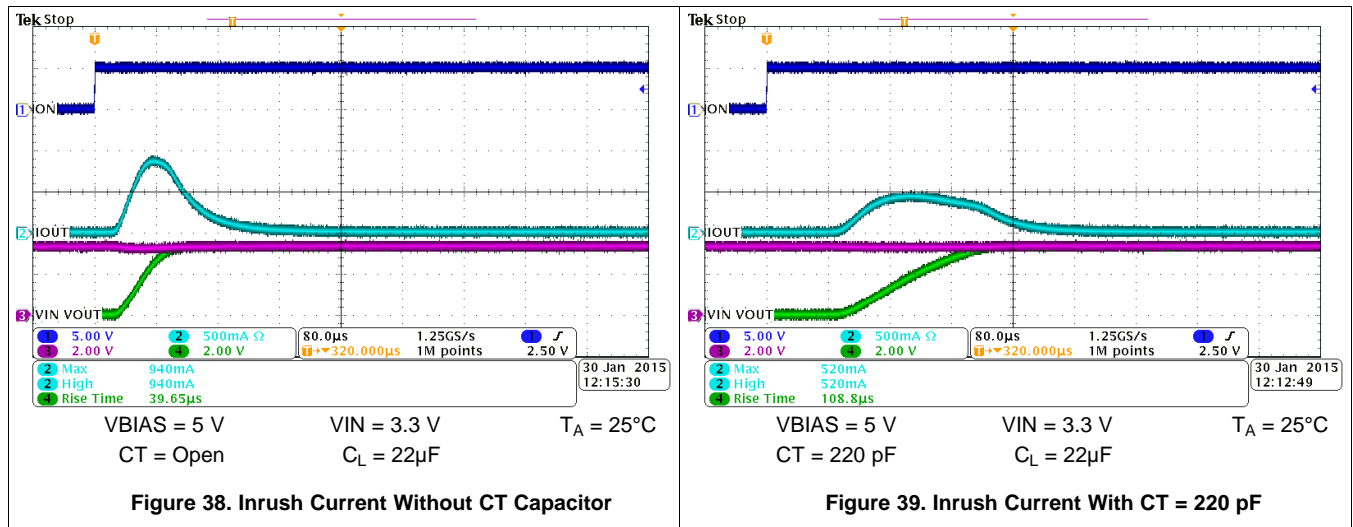

## 11 Power Supply Recommendations

The device is designed to operate from a  $V_{BIAS}$  range of 2.5 to 5.5 V and  $V_{IN}$  range of 0.6 to 5.5 V. The power supply should be well regulated and placed as close to the device terminals as possible. It must be able to withstand all transient and load current steps. In most situations, using the minimum recommended input capacitance of 1  $\mu$ F is sufficient to prevent the supply voltage from dipping when the switch is turned on. In cases where the power supply is slow to respond to a large transient current or large load current step, additional bulk capacitance may be required on the input. To avoid ringing on the VBIAS pin from a noisy power supply, a bypass capacitance of 0.1  $\mu$ F is recommended.

The requirements for large input capacitance can be mitigated by adding additional capacitance to the CT pin. This will cause the load switch to turn on more slowly. Not only will this reduce transient inrush current, but it will also give the power supply more time to respond to the load current step.

## 12 Layout

### 12.1 Layout Guidelines

- VIN and VOUT traces should be as short and wide as possible to accommodate for high current. When connecting the two VIN or VOUT pins together, an equal trace length should be used to avoid an unequal distribution of current through each pin.
- Use vias under the exposed thermal pad to connect to the power ground plane for thermal relief during high current operation.
- VIN pins should be bypassed to ground with low-ESR ceramic bypass capacitors. The typical recommended bypass capacitance is 1- $\mu$ F ceramic with X5R or X7R dielectric. This capacitor should be placed as close to the device pins as possible.
- VOUT pins should be bypassed to ground with low-ESR ceramic bypass capacitors. The typical recommended bypass capacitance is one-tenth of the VIN bypass capacitor of X5R or X7R dielectric rating. This capacitor should be placed as close to the device pins as possible.
- The CT capacitor should be placed as close to the device pins as possible. The typical recommended CT capacitance is a capacitor of X5R or X7R dielectric rating with a rating of 25 V or higher.



## 12.2 Layout Example

○ VIA to Power Ground Plane      ○ VIA to another layer

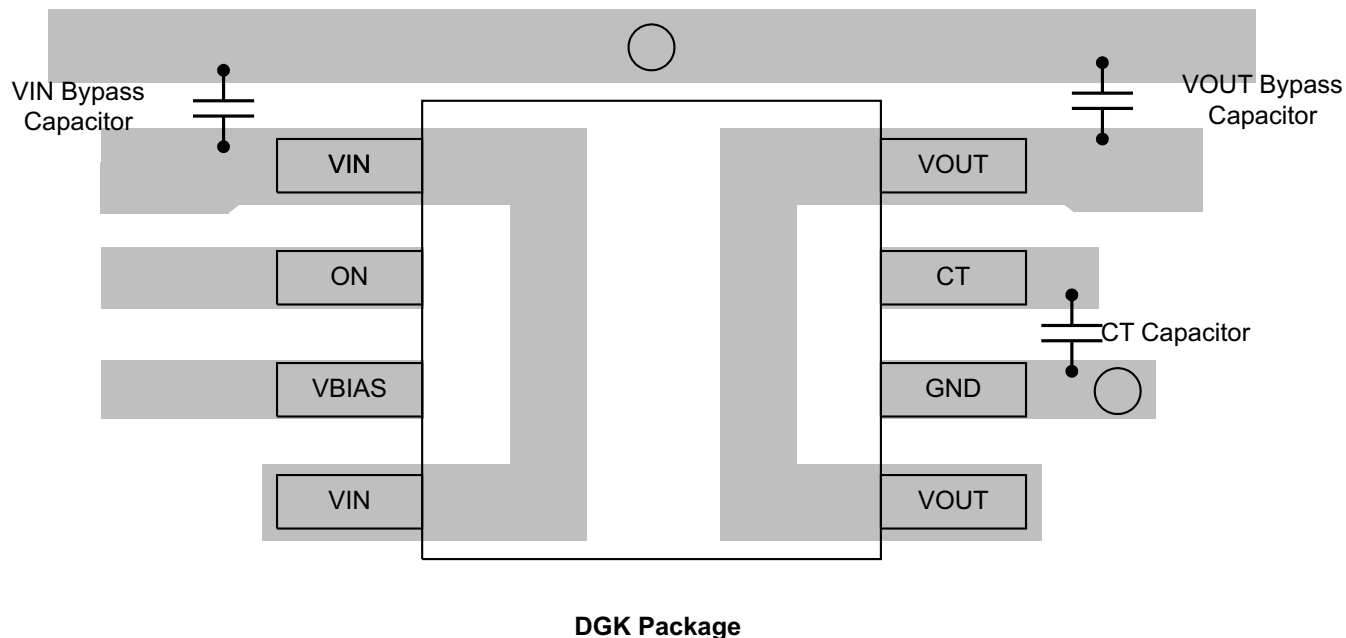
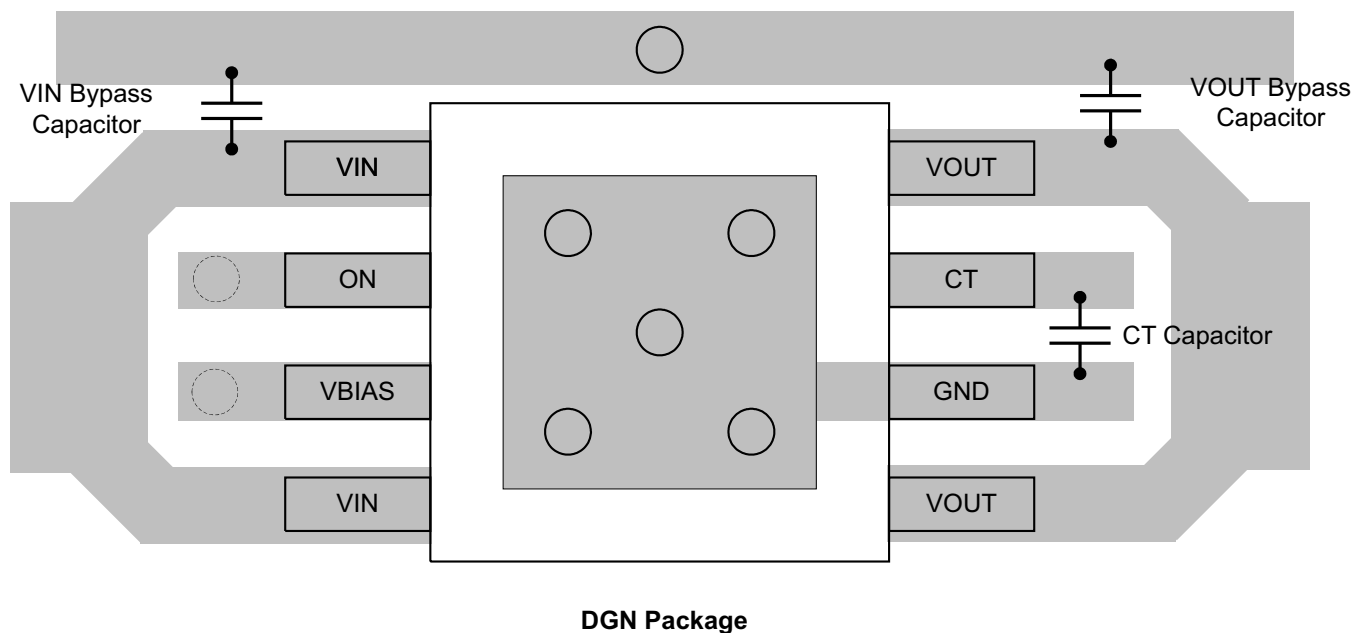

## 13 Device and Documentation Support

### 13.1 Related Links

The table below lists quick access links. Categories include technical documents, support and community resources, tools and software, and quick access to sample or buy.

**Table 4. Related Links**

PARTS	PRODUCT FOLDER	SAMPLE & BUY	TECHNICAL DOCUMENTS	TOOLS & SOFTWARE	SUPPORT & COMMUNITY
TPS22958	<a href="#">Click here</a>	<a href="#">Click here</a>	<a href="#">Click here</a>	<a href="#">Click here</a>	<a href="#">Click here</a>
TPS22958N	<a href="#">Click here</a>	<a href="#">Click here</a>	<a href="#">Click here</a>	<a href="#">Click here</a>	<a href="#">Click here</a>

### 13.2 Trademarks

All trademarks are the property of their respective owners.

### 13.3 Electrostatic Discharge Caution



These devices have limited built-in ESD protection. The leads should be shorted together or the device placed in conductive foam during storage or handling to prevent electrostatic damage to the MOS gates.

### 13.4 Glossary

[SLYZ022](#) — *TI Glossary*.

This glossary lists and explains terms, acronyms, and definitions.

## 14 Mechanical, Packaging, and Orderable Information

The following pages include mechanical, packaging, and orderable information. This information is the most current data available for the designated devices. This data is subject to change without notice and revision of this document. For browser-based versions of this data sheet, refer to the left-hand navigation.

**PACKAGING INFORMATION**

Orderable part number	Status (1)	Material type (2)	Package   Pins	Package qty   Carrier	RoHS (3)	Lead finish/ Ball material (4)	MSL rating/ Peak reflow (5)	Op temp (°C)	Part marking (6)
<a href="#">TPS22958DGKR</a>	Active	Production	VSSOP (DGK)   8	2500   LARGE T&R	Yes	NIPDAUAG	Level-1-260C-UNLIM	-40 to 105	(ZBUO, ZBUX)
TPS22958DGKR.A	Active	Production	VSSOP (DGK)   8	2500   LARGE T&R	Yes	NIPDAUAG	Level-1-260C-UNLIM	-40 to 105	(ZBUO, ZBUX)
<a href="#">TPS22958DGNR</a>	Active	Production	HVSSOP (DGN)   8	2500   LARGE T&R	Yes	NIPDAUAG	Level-1-260C-UNLIM	-40 to 105	ZBVX
TPS22958DGNR.A	Active	Production	HVSSOP (DGN)   8	2500   LARGE T&R	Yes	NIPDAUAG	Level-1-260C-UNLIM	-40 to 105	ZBVX
<a href="#">TPS22958NDGKR</a>	Active	Production	VSSOP (DGK)   8	2500   LARGE T&R	Yes	NIPDAUAG	Level-1-260C-UNLIM	-40 to 105	ZBWX
TPS22958NDGKR.A	Active	Production	VSSOP (DGK)   8	2500   LARGE T&R	Yes	NIPDAUAG	Level-1-260C-UNLIM	-40 to 105	ZBWX
<a href="#">TPS22958NDGNR</a>	Active	Production	HVSSOP (DGN)   8	2500   LARGE T&R	Yes	NIPDAUAG	Level-1-260C-UNLIM	-40 to 105	ZBXX
TPS22958NDGNR.A	Active	Production	HVSSOP (DGN)   8	2500   LARGE T&R	Yes	NIPDAUAG	Level-1-260C-UNLIM	-40 to 105	ZBXX

(1) **Status:** For more details on status, see our [product life cycle](#).

(2) **Material type:** When designated, preproduction parts are prototypes/experimental devices, and are not yet approved or released for full production. Testing and final process, including without limitation quality assurance, reliability performance testing, and/or process qualification, may not yet be complete, and this item is subject to further changes or possible discontinuation. If available for ordering, purchases will be subject to an additional waiver at checkout, and are intended for early internal evaluation purposes only. These items are sold without warranties of any kind.

(3) **RoHS values:** Yes, No, RoHS Exempt. See the [TI RoHS Statement](#) for additional information and value definition.

(4) **Lead finish/Ball material:** Parts may have multiple material finish options. Finish options are separated by a vertical ruled line. Lead finish/Ball material values may wrap to two lines if the finish value exceeds the maximum column width.

(5) **MSL rating/Peak reflow:** The moisture sensitivity level ratings and peak solder (reflow) temperatures. In the event that a part has multiple moisture sensitivity ratings, only the lowest level per JEDEC standards is shown. Refer to the shipping label for the actual reflow temperature that will be used to mount the part to the printed circuit board.

(6) **Part marking:** There may be an additional marking, which relates to the logo, the lot trace code information, or the environmental category of the part.

Multiple part markings will be inside parentheses. Only one part marking contained in parentheses and separated by a "-" will appear on a part. If a line is indented then it is a continuation of the previous line and the two combined represent the entire part marking for that device.

**Important Information and Disclaimer:** The information provided on this page represents TI's knowledge and belief as of the date that it is provided. TI bases its knowledge and belief on information provided by third parties, and makes no representation or warranty as to the accuracy of such information. Efforts are underway to better integrate information from third parties. TI has taken and continues to take reasonable steps to provide representative and accurate information but may not have conducted destructive testing or chemical analysis on incoming materials and chemicals. TI and TI suppliers consider certain information to be proprietary, and thus CAS numbers and other limited information may not be available for release.

In no event shall TI's liability arising out of such information exceed the total purchase price of the TI part(s) at issue in this document sold by TI to Customer on an annual basis.

**TAPE AND REEL INFORMATION**

**QUADRANT ASSIGNMENTS FOR PIN 1 ORIENTATION IN TAPE**

\*All dimensions are nominal

Device	Package Type	Package Drawing	Pins	SPQ	Reel Diameter (mm)	Reel Width W1 (mm)	A0 (mm)	B0 (mm)	K0 (mm)	P1 (mm)	W (mm)	Pin1 Quadrant
TPS22958DGKR	VSSOP	DGK	8	2500	330.0	12.4	5.3	3.3	1.3	8.0	12.0	Q1
TPS22958DGKR	VSSOP	DGK	8	2500	330.0	12.4	5.3	3.4	1.4	8.0	12.0	Q1
TPS22958DGNR	HVSSOP	DGN	8	2500	330.0	12.4	5.3	3.4	1.4	8.0	12.0	Q1
TPS22958NDGKR	VSSOP	DGK	8	2500	330.0	12.4	5.3	3.4	1.4	8.0	12.0	Q1
TPS22958NDGNR	HVSSOP	DGN	8	2500	330.0	12.4	5.3	3.4	1.4	8.0	12.0	Q1

**TAPE AND REEL BOX DIMENSIONS**

\*All dimensions are nominal

Device	Package Type	Package Drawing	Pins	SPQ	Length (mm)	Width (mm)	Height (mm)
TPS22958DGKR	VSSOP	DGK	8	2500	346.0	346.0	35.0
TPS22958DGKR	VSSOP	DGK	8	2500	364.0	364.0	27.0
TPS22958DGNR	HVSSOP	DGN	8	2500	364.0	364.0	27.0
TPS22958NDGKR	VSSOP	DGK	8	2500	364.0	364.0	27.0
TPS22958NDGNR	HVSSOP	DGN	8	2500	364.0	364.0	27.0

# DGK0008A



# PACKAGE OUTLINE

VSSOP - 1.1 mm max height

SMALL OUTLINE PACKAGE



4214862/A 04/2023

**NOTES:**

PowerPAD is a trademark of Texas Instruments.

1. All linear dimensions are in millimeters. Any dimensions in parenthesis are for reference only. Dimensioning and tolerancing per ASME Y14.5M.
2. This drawing is subject to change without notice.
3. This dimension does not include mold flash, protrusions, or gate burrs. Mold flash, protrusions, or gate burrs shall not exceed 0.15 mm per side.
4. This dimension does not include interlead flash. Interlead flash shall not exceed 0.25 mm per side.
5. Reference JEDEC registration MO-187.

# EXAMPLE BOARD LAYOUT

DGK0008A

™ VSSOP - 1.1 mm max height

SMALL OUTLINE PACKAGE



LAND PATTERN EXAMPLE  
EXPOSED METAL SHOWN  
SCALE: 15X



SOLDER MASK DETAILS

4214862/A 04/2023

NOTES: (continued)

6. Publication IPC-7351 may have alternate designs.
7. Solder mask tolerances between and around signal pads can vary based on board fabrication site.
8. Vias are optional depending on application, refer to device data sheet. If any vias are implemented, refer to their locations shown on this view. It is recommended that vias under paste be filled, plugged or tented.
9. Size of metal pad may vary due to creepage requirement.



# EXAMPLE STENCIL DESIGN

DGK0008A

™ VSSOP - 1.1 mm max height

SMALL OUTLINE PACKAGE

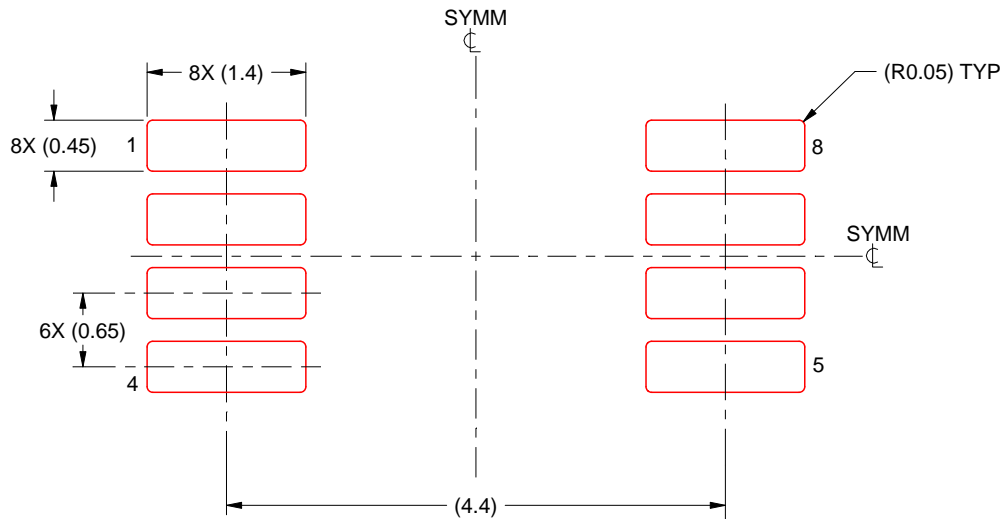

SOLDER PASTE EXAMPLE  
SCALE: 15X

4214862/A 04/2023

NOTES: (continued)

11. Laser cutting apertures with trapezoidal walls and rounded corners may offer better paste release. IPC-7525 may have alternate design recommendations.
12. Board assembly site may have different recommendations for stencil design.

## GENERIC PACKAGE VIEW

**DGN 8**

**PowerPAD™ HVSSOP - 1.1 mm max height**

3 x 3, 0.65 mm pitch

SMALL OUTLINE PACKAGE

This image is a representation of the package family, actual package may vary.  
Refer to the product data sheet for package details.

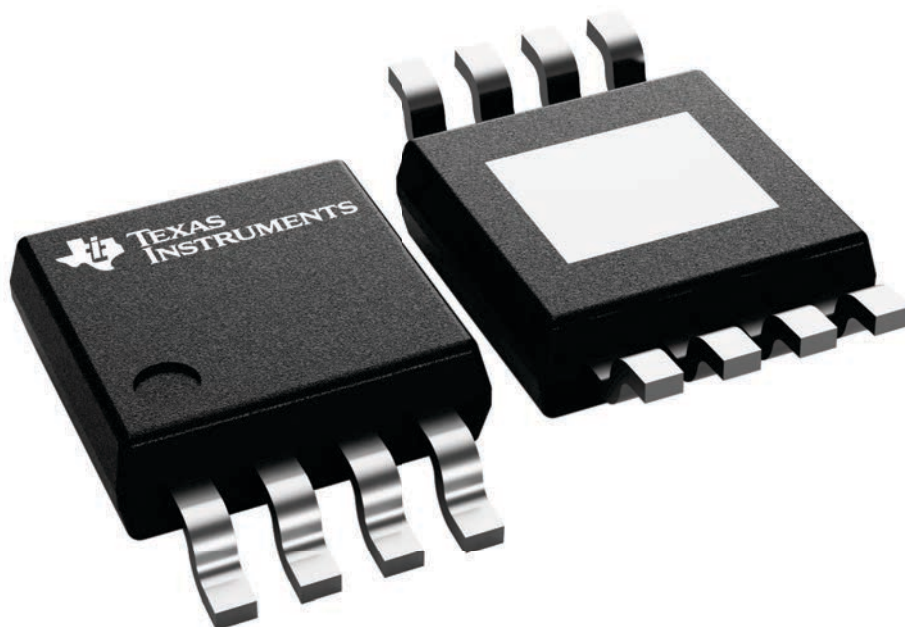

4225482/B

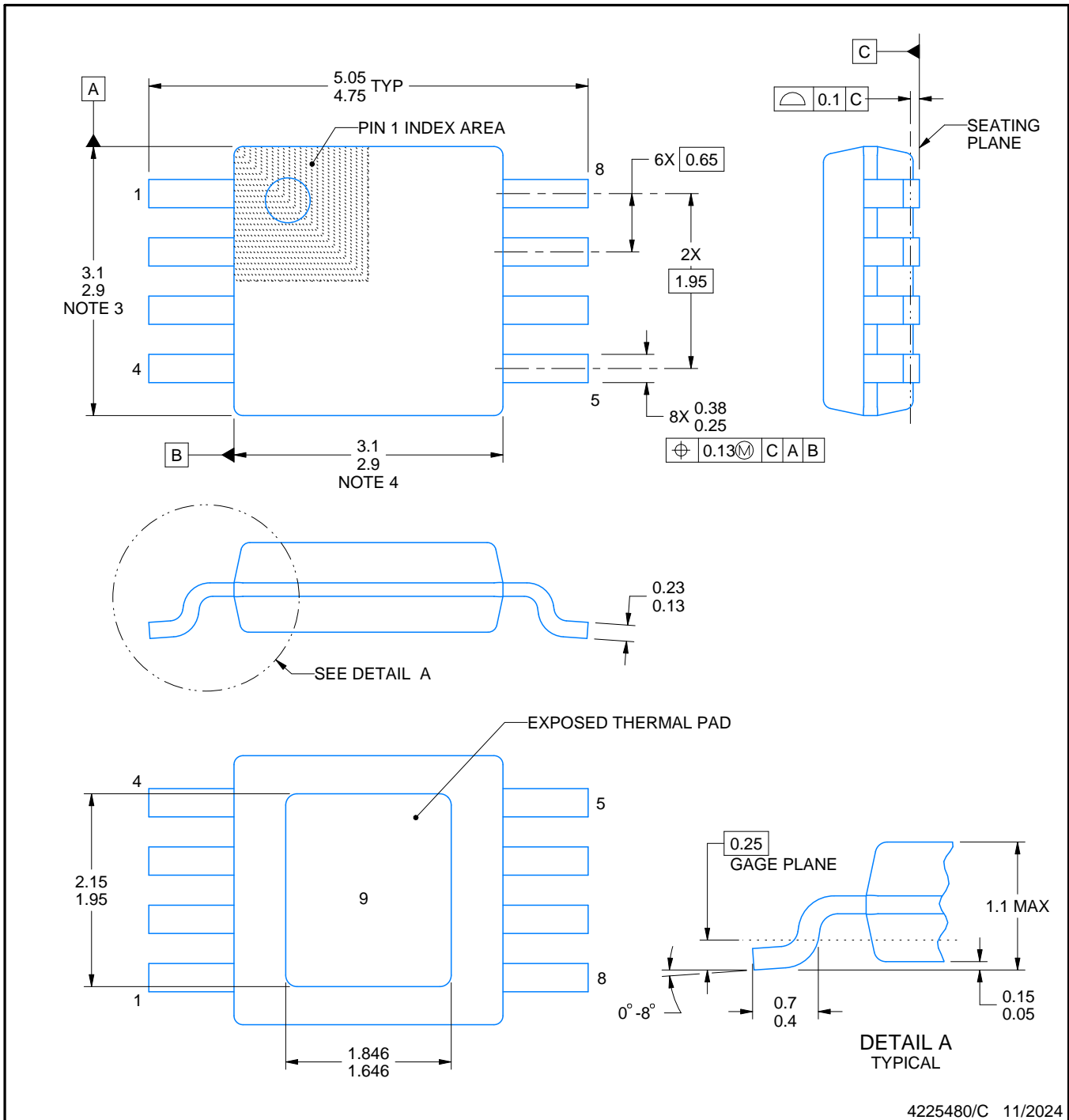
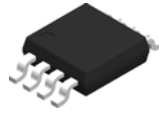

4225480/C 11/2024

PowerPAD is a trademark of Texas Instruments.

NOTES:

1. All linear dimensions are in millimeters. Any dimensions in parenthesis are for reference only. Dimensioning and tolerancing per ASME Y14.5M.
2. This drawing is subject to change without notice.
3. This dimension does not include mold flash, protrusions, or gate burrs. Mold flash, protrusions, or gate burrs shall not exceed 0.15 mm per side.
4. This dimension does not include interlead flash. Interlead flash shall not exceed 0.25 mm per side.
5. Reference JEDEC registration MO-187.

# EXAMPLE BOARD LAYOUT

DGN0008G

PowerPAD™ HVSSOP - 1.1 mm max height

SMALL OUTLINE PACKAGE

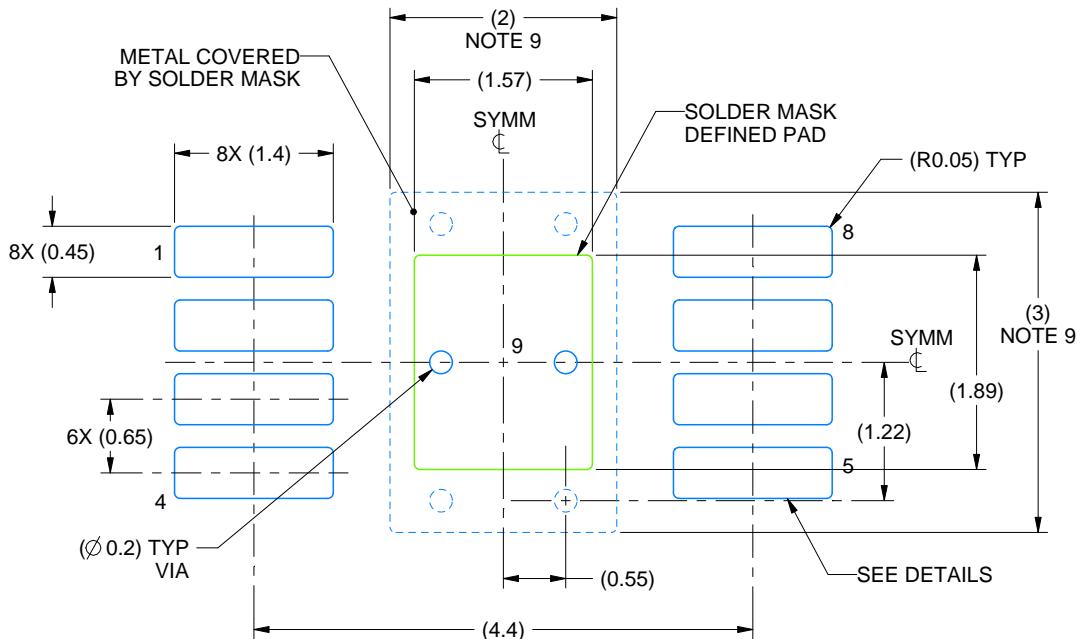

LAND PATTERN EXAMPLE  
EXPOSED METAL SHOWN  
SCALE: 15X

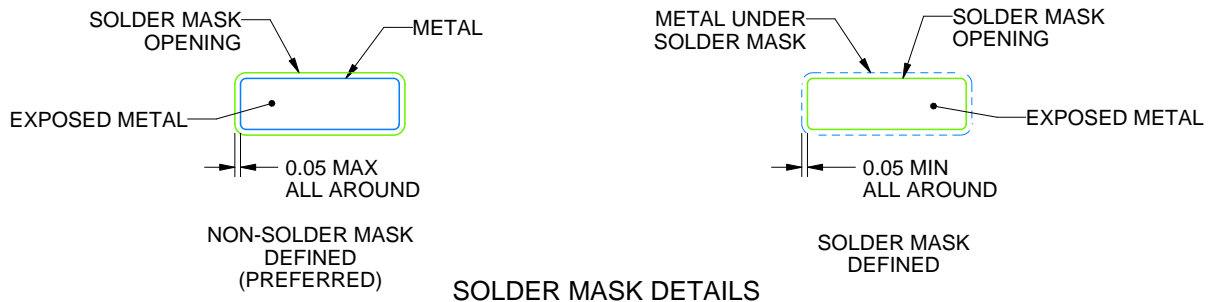

SOLDER MASK DETAILS

4225480/C 11/2024

NOTES: (continued)

6. Publication IPC-7351 may have alternate designs.
7. Solder mask tolerances between and around signal pads can vary based on board fabrication site.
8. Vias are optional depending on application, refer to device data sheet. If any vias are implemented, refer to their locations shown on this view. It is recommended that vias under paste be filled, plugged or tented.
9. Size of metal pad may vary due to creepage requirement.

# EXAMPLE STENCIL DESIGN

DGN0008G

PowerPAD™ HVSSOP - 1.1 mm max height

SMALL OUTLINE PACKAGE

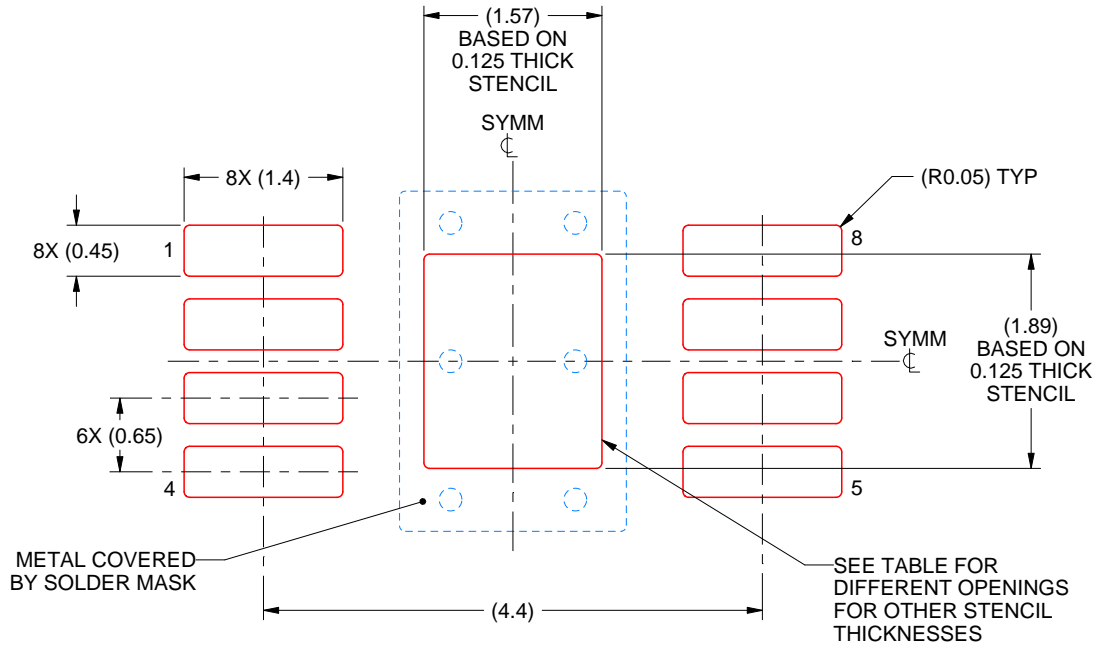

**SOLDER PASTE EXAMPLE**  
 EXPOSED PAD 9:  
 100% PRINTED SOLDER COVERAGE BY AREA  
 SCALE: 15X

STENCIL THICKNESS	SOLDER STENCIL OPENING
0.1	1.76 X 2.11
0.125	1.57 X 1.89 (SHOWN)
0.15	1.43 X 1.73
0.175	1.33 X 1.60

4225480/C 11/2024

NOTES: (continued)

10. Laser cutting apertures with trapezoidal walls and rounded corners may offer better paste release. IPC-7525 may have alternate design recommendations.
11. Board assembly site may have different recommendations for stencil design.

## IMPORTANT NOTICE AND DISCLAIMER

TI PROVIDES TECHNICAL AND RELIABILITY DATA (INCLUDING DATASHEETS), DESIGN RESOURCES (INCLUDING REFERENCE DESIGNS), APPLICATION OR OTHER DESIGN ADVICE, WEB TOOLS, SAFETY INFORMATION, AND OTHER RESOURCES "AS IS" AND WITH ALL FAULTS, AND DISCLAIMS ALL WARRANTIES, EXPRESS AND IMPLIED, INCLUDING WITHOUT LIMITATION ANY IMPLIED WARRANTIES OF MERCHANTABILITY, FITNESS FOR A PARTICULAR PURPOSE OR NON-INFRINGEMENT OF THIRD PARTY INTELLECTUAL PROPERTY RIGHTS.

These resources are intended for skilled developers designing with TI products. You are solely responsible for (1) selecting the appropriate TI products for your application, (2) designing, validating and testing your application, and (3) ensuring your application meets applicable standards, and any other safety, security, regulatory or other requirements.

These resources are subject to change without notice. TI grants you permission to use these resources only for development of an application that uses the TI products described in the resource. Other reproduction and display of these resources is prohibited. No license is granted to any other TI intellectual property right or to any third party intellectual property right. TI disclaims responsibility for, and you fully indemnify TI and its representatives against any claims, damages, costs, losses, and liabilities arising out of your use of these resources.

TI's products are provided subject to [TI's Terms of Sale](#), [TI's General Quality Guidelines](#), or other applicable terms available either on [ti.com](#) or provided in conjunction with such TI products. TI's provision of these resources does not expand or otherwise alter TI's applicable warranties or warranty disclaimers for TI products. Unless TI explicitly designates a product as custom or customer-specified, TI products are standard, catalog, general purpose devices.

TI objects to and rejects any additional or different terms you may propose.

Copyright © 2025, Texas Instruments Incorporated

Last updated 10/2025