

# TPS7A88-Q1 Automotive, Dual, 1-A, Low-Noise (4 $\mu\text{V}_{\text{RMS}}$ ) LDO Voltage Regulator

## 1 Features

- AEC-Q100 Qualified With the Following Results:
  - Temperature Grade 1:  $-40^{\circ}\text{C} \leq T_A \leq +125^{\circ}\text{C}$
  - HBM ESD Classification Level 2
  - CDM ESD Classification Level C5
- Two Independent LDO Channels
- Low Output Noise: 4  $\mu\text{V}_{\text{RMS}}$  (10 Hz to 100 kHz)
- Low Dropout: 230 mV (Maximum) at 1 A
- Wide Input Voltage Range: 1.4 V to 6.5 V
- Wide Output Voltage Range: 0.8 V to 5.15 V
- High Power-Supply Ripple Rejection:
  - 70 dB at 100 Hz
  - 40 dB at 100 kHz
  - 40 dB at 1 MHz
- 1% Accuracy Over Line, Load, and Temperature
- Excellent Load Transient Response
- Adjustable Start-Up Inrush Control
- Selectable Soft-Start Charging Current
- Independent Open-Drain Power-Good (PG) Outputs
- Stable With a 10- $\mu\text{F}$  or Larger Ceramic Output Capacitor
- Low Thermal Resistance:  $R_{\theta\text{JA}} = 39.8^{\circ}\text{C}/\text{W}$
- 4-mm x 4-mm Wettable Flank WQFN Package

## 2 Applications

- RF and Radar Power in Automotive Applications
- Automotive ADAS ECUs
- Telematic Control Units
- Infotainment and Clusters
- High-Speed I/F (PLL and VCO)

### Typical Application Diagram

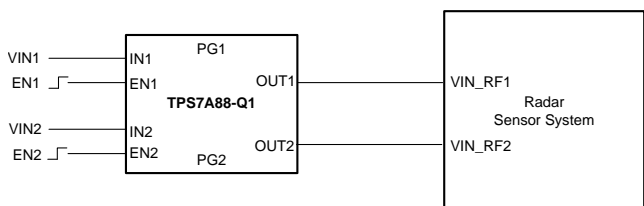

Copyright © 2017, Texas Instruments Incorporated

## 3 Description

The TPS7A88-Q1 is a dual, low-noise (4  $\mu\text{V}_{\text{RMS}}$ ), low-dropout (LDO) voltage regulator capable of sourcing 1 A per channel with 250 mV of maximum dropout.

The TPS7A88-Q1 provides the flexibility of two independent LDOs and approximately 50% smaller solution size than two single-channel LDOs. Each output is adjustable with external resistors from 0.8 V to 5.15 V. The TPS7A88-Q1 wide input-voltage range supports operation as low as 1.4 V and up to 6.5 V.

With 1% output voltage accuracy (over line, load, and temperature) and soft-start capabilities to reduce in-rush current, the TPS7A88-Q1 is ideal for powering sensitive analog low-voltage devices (such as voltage-controlled oscillators [VCOs], analog-to-digital converters [ADCs], digital-to-analog converters [DACs], high-end processors, and field-programmable gate arrays [FPGAs]).

The TPS7A88-Q1 is designed to power noise-sensitive components such as those found in RF, radar communications, and telematic applications. The low 4- $\mu\text{V}_{\text{RMS}}$  output noise and wideband PSRR (40 dB at 1 MHz) minimizes phase noise and clock jitter. These features maximize performance of clocking devices, ADCs, and DACs. The TPS7A88-Q1 features wettable flanks for simple optical inspection.

### Device Information<sup>(1)</sup>

PART NUMBER	PACKAGE	BODY SIZE (NOM)
TPS7A88-Q1	WQFN (20)	4.00 mm x 4.00 mm

(1) For all available packages, see the package option addendum at the end of the data sheet.

### Spectral Noise Density vs Output Voltage

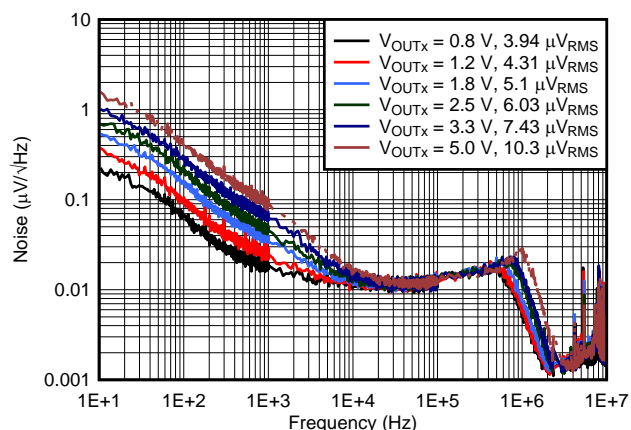

## Table of Contents

<b>1 Features</b> .....	<b>1</b>	7.4 Device Functional Modes.....	<b>18</b>
<b>2 Applications</b> .....	<b>1</b>	<b>8 Application and Implementation</b> .....	<b>19</b>
<b>3 Description</b> .....	<b>1</b>	8.1 Application Information.....	<b>19</b>
<b>4 Revision History</b> .....	<b>2</b>	8.2 Typical Application .....	<b>30</b>
<b>5 Pin Configuration and Functions</b> .....	<b>3</b>	<b>9 Power Supply Recommendations</b> .....	<b>32</b>
<b>6 Specifications</b> .....	<b>4</b>	<b>10 Layout</b> .....	<b>32</b>
6.1 Absolute Maximum Ratings .....	4	10.1 Layout Guidelines .....	32
6.2 ESD Ratings.....	4	10.2 Layout Example .....	33
6.3 Recommended Operating Conditions.....	4	<b>11 Device and Documentation Support</b> .....	<b>34</b>
6.4 Thermal Information .....	4	11.1 Device Support .....	34
6.5 Electrical Characteristics.....	5	11.2 Documentation Support .....	34
6.6 Typical Characteristics .....	7	11.3 Community Resources.....	34
<b>7 Detailed Description</b> .....	<b>14</b>	11.4 Trademarks .....	35
7.1 Overview .....	14	11.5 Electrostatic Discharge Caution.....	35
7.2 Functional Block Diagram .....	14	11.6 Glossary .....	35
7.3 Feature Description.....	15	<b>12 Mechanical, Packaging, and Orderable Information</b> .....	<b>35</b>

## 4 Revision History

### Changes from Original (August 2017) to Revision A

**Page**

- Changed Low Thermal Resistance:  $R_{\theta JA}$  from 40°C/W to 39.8°C/W to match *Thermal Information* table content ..... **1**
- Deleted output voltage range from *Recommended Operating Conditions* table; this parameter is already listed in the *Electrical Characteristics* table ..... **4**
- Changed ENx pin current parameter min and max values from  $\pm 0.2 \mu\text{A}$  to  $\pm 0.5 \mu\text{A}$  in *Electrical Characteristics* table..... **5**

## 5 Pin Configuration and Functions

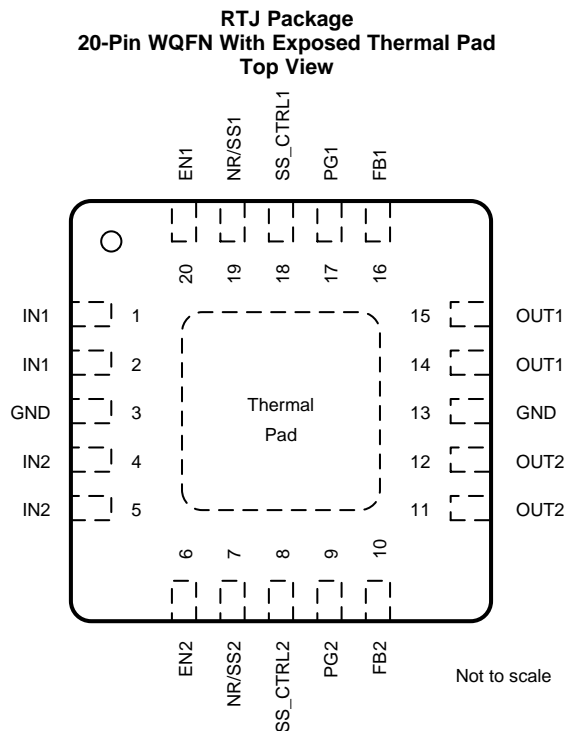

### Pin Functions

PIN			DESCRIPTION
NAME	NO.	I/O	
EN1	20	I	Enable pin for each channel. These pins turn the regulator on and off. If $V_{ENx}^{(1)} \geq V_{IH(ENx)}$ , then the regulator is enabled. If $V_{ENx} \leq V_{IL(ENx)}$ , then the regulator is disabled. The ENx pin must be connected to INx if the enable function is not used.
EN2	6		
FB1	16	I	Feedback pins connected to the error amplifier. Although not required, a TI recommends a 10-nF feedforward capacitor from FBx to OUTx (as close as possible to the device) to maximize AC performance. The use of a feedforward capacitor can disrupt PGx (power good) functionality. See <a href="#">Feedforward Capacitor (C<sub>FFx</sub>)</a> and <a href="#">Setting the Output Voltage (Adjustable Operation)</a> for more details.
FB2	10		
GND	3, 13	—	Ground pins. These pins must be connected to ground, the thermal pad, and each other with a low-impedance connection.
IN1	1, 2	I	Input supply pins for LDO 1. An input capacitor with a value of 10 $\mu$ F or larger (5 $\mu$ F or greater of effective capacitance) is required. Place the input capacitor as close as possible to the input.
IN2	4, 5	I	Input supply pins for LDO 2. An input capacitor with a value of 10 $\mu$ F or larger (5 $\mu$ F or greater of effective capacitance) is required. Place the input capacitor as close as possible to the input.
NR/SS1	19	—	Noise-reduction and soft-start pin for each channel. Connecting an external capacitor between this pin and ground reduces reference voltage noise and enables the soft-start function. Although not required, TI recommends connecting a capacitor with a value of 10 nF or larger from NR/SSx to GND (as close as possible to the pin) to maximize AC performance. See <a href="#">Noise-Reduction and Soft-Start Capacitor (C<sub>NR/SSx</sub>)</a> for more details.
NR/SS2	7		
OUT1	14, 15	O	Regulated outputs for LDO 1. A ceramic capacitor with a value of 5 $\mu$ F or larger (10 $\mu$ F or greater of effective capacitance) from OUTx to ground is required for stability and must be placed as close as possible to the output. Minimize the impedance from the OUT1 pin to the load. See <a href="#">Input and Output Capacitor (C<sub>INx</sub> and C<sub>OUTx</sub>)</a> for more details.
OUT2	11, 12	O	Regulated outputs for LDO 2. A ceramic capacitor with a value of 10 $\mu$ F or larger (5 $\mu$ F or greater of effective capacitance) from OUTx to ground is required for stability and must be placed as close as possible to the output. Minimize the impedance from the OUT2 pin to the load. See <a href="#">Input and Output Capacitor (C<sub>INx</sub> and C<sub>OUTx</sub>)</a> for more details.
PG1	17	O	Open-drain power-good indicator pins for the LDO 1 and LDO 2 output voltages. A 10-k $\Omega$ to 100-k $\Omega$ external pullup resistor is required. These pins can be left floating or connected to GND if not used. The use of a feedforward capacitor can disrupt power-good functionality. See <a href="#">Feedforward Capacitor (C<sub>FFx</sub>)</a> for more details.
PG2	9		
SS_CTRL1	18	I	Soft-start control pins for each channel. Connect these pins to GND or INx to allow normal or fast charging of the NR/SSx capacitor. If a C <sub>NR/SSx</sub> capacitor is not used, SS_CTRLx must be connected to GND to avoid output overshoot.
SS_CTRL2	8		
Thermal pad		—	Connect the thermal pad to a large-area ground plane. The thermal pad is internally connected to GND.

(1) Lowercase x indicates that the specification under consideration applies to both channel 1 and channel 2, one channel at a time.

## 6 Specifications

### 6.1 Absolute Maximum Ratings

over operating junction temperature range and all voltages with respect to GND (unless otherwise noted)<sup>(1) (2)</sup>

		MIN	MAX	UNIT
Voltage	INx, PGx, ENx	-0.3	7	V
	OUTx, SS_CTRLx	-0.3	$V_{INx} + 0.3$ <sup>(3)</sup>	
	NR/SSx, FBx	-0.3	3.6	
Current	OUTx	Internally limited	Internally limited	A
	PGx (sink current into device)		5	mA
Operating junction temperature, $T_J$		-55	150	°C
Storage temperature, $T_{stg}$		-55	150	°C

- (1) Stresses beyond those listed under *Absolute Maximum Ratings* may cause permanent damage to the device. These are stress ratings only, which do not imply functional operation of the device at these or any other conditions beyond those indicated under *Recommended Operating Conditions*. Exposure to absolute-maximum-rated conditions for extended periods may affect device reliability.
- (2) Lowercase x indicates that the specification under consideration applies to both channel 1 and channel 2, one channel at a time.
- (3) The absolute maximum rating is  $V_{INx} + 0.3$  V or 7 V, whichever is smaller.

### 6.2 ESD Ratings

		VALUE	UNIT
$V_{(ESD)}$ Electrostatic discharge	Human-body model (HBM), per AEC Q100-002 <sup>(1)</sup>	±2000	V
	Charged-device model (CDM), per AEC Q100-011	±750	

- (1) AEC Q100-002 indicates that HBM stressing shall be in accordance with the ANSI/ESDA/JEDEC JS-001 specification.

### 6.3 Recommended Operating Conditions

over operating junction temperature range (unless otherwise noted)

		MIN	MAX	UNIT
$V_{INx}$	Input supply voltage range	1.4	6.5	V
$I_{OUTx}$	Output current	0	1	A
$C_{INx}$	Input capacitor, each input	10		µF
$C_{OUTx}$	Output capacitor, each output	10		µF
$C_{NR/SSx}$	Noise-reduction capacitor		1	µF
$R_{PG}$	Power-good pullup resistance	10	100	kΩ
$T_J$	Junction temperature range	-40	140	°C

### 6.4 Thermal Information

THERMAL METRIC <sup>(1)</sup>		TPS7A88-Q1	UNIT
		RTJ (WQFN)	
		20 PINS	
$R_{\theta JA}$	Junction-to-ambient thermal resistance	39.8	°C/W
$R_{\theta JC(top)}$	Junction-to-case (top) thermal resistance	27.7	°C/W
$R_{\theta JB}$	Junction-to-board thermal resistance	16.9	°C/W
$\Psi_{JT}$	Junction-to-top characterization parameter	0.3	°C/W
$\Psi_{JB}$	Junction-to-board characterization parameter	16.6	°C/W
$R_{\theta JC(bot)}$	Junction-to-case (bottom) thermal resistance	1.5	°C/W

- (1) For more information about traditional and new thermal metrics, see the [Semiconductor and IC Package Thermal Metrics](#) application report.

## 6.5 Electrical Characteristics

over operating temperature range ( $T_J = -40^\circ\text{C}$  to  $+140^\circ\text{C}$ ),  $V_{INx} = 1.4\text{ V}$ ,  $V_{OUTx(TARGET)} = 0.8\text{ V}$ ,  $I_{OUTx} = 5\text{ mA}$ ,  $V_{ENx} = 1.4\text{ V}$ ,  $C_{OUTx} = 10\text{ }\mu\text{F}$ ,  $C_{NR/SSx} = 0\text{ nF}$ ,  $C_{FFx} = 0\text{ nF}$ ,  $SS\_CTRL_x = \text{GND}$ ,  $PG_x$  pin pulled up to  $V_{INx}$  with  $100\text{ k}\Omega$ , and for each channel; typical values are at  $T_J = 25^\circ\text{C}$  <sup>(1)</sup> (unless otherwise noted)

PARAMETER		TEST CONDITIONS	MIN	TYP	MAX	UNIT
$V_{INx}$	Input supply voltage range		1.4		6.5	V
$V_{REF}$	Reference voltage			0.8		V
$V_{UVLO}$	Input supply UVLO	$V_{INx}$ rising		1.31	1.39	V
$V_{HYS}$	$V_{UVLO}$ Hysteresis			290		mV
$V_{OUTx}$	Output voltage range	$T_J = -40^\circ\text{C}$ to $+125^\circ\text{C}$	0.8 – 1%		5.15 + 1%	V
			0.8 – 1.5%		5.15 + 1%	
	Output voltage accuracy <sup>(2)(3)</sup>	$0.8\text{ V} \leq V_{OUTx} \leq 5.15\text{ V}$ $5\text{ mA} \leq I_{OUTx} \leq 1\text{ A}$ $T_J = -40^\circ\text{C}$ to $+125^\circ\text{C}$	-1%		1%	
		$0.8\text{ V} \leq V_{OUTx} \leq 5.15\text{ V}$ $5\text{ mA} \leq I_{OUTx} \leq 1\text{ A}$	-1.5%		1%	
$\Delta V_{OUTx(\Delta V_{INx})}$	Line regulation	$I_{OUTx} = 5\text{ mA}$ $1.4\text{ V} \leq V_{INx} \leq 6.5\text{ V}$		0.003		%/V
$\Delta V_{OUTx(\Delta I_{OUTx})}$	Load regulation	$5\text{ mA} \leq I_{OUTx} \leq 1\text{ A}$		0.03		%/A
$V_{DO}$	Dropout voltage	$V_{INx} \geq 1.4\text{ V}$ $0.8\text{ V} \leq V_{OUTx} \leq 5.15\text{ V}$ $I_{OUTx} = 1\text{ A}$ $V_{FBx} = 0.8\text{ V} - 3\%$ , $T_J = -40^\circ\text{C}$ to $+125^\circ\text{C}$			225	mV
		$V_{INx} \geq 1.4\text{ V}$ , $0.8\text{ V} \leq V_{OUTx} \leq 5.15\text{ V}$ , $I_{OUTx} = 1\text{ A}$ , $V_{FBx} = 0.8\text{ V} - 3\%$			250	mV
$I_{LIM}$	Output current limit	$V_{OUTx}$ forced at $0.9 \times V_{OUTx(TARGET)}$ , $V_{INx} = V_{OUTx(TARGET)} + 300\text{ mV}$	1.5	1.7	1.9	A
$I_{GND}$	GND pin current	Both channels enabled, per channel $V_{INx} = 6.5\text{ V}$ , $I_{OUTx} = 5\text{ mA}$		2.1	3.5	mA
		Both channels enabled, per channel $V_{INx} = 1.4\text{ V}$ , $I_{OUTx} = 1\text{ A}$			4	
$I_{SDN}$	Shutdown GND pin current	Both channels shutdown, per channel, $PG_x = (\text{open})$ $V_{INx} = 6.5\text{ V}$ $V_{ENx} = 0.4\text{ V}$		0.1	15	$\mu\text{A}$
$I_{ENx}$	ENx pin current	$V_{INx} = 6.5\text{ V}$ $0\text{ V} \leq V_{ENx} \leq 6.5\text{ V}$	-0.5		0.5	$\mu\text{A}$
$V_{IL(ENx)}$	ENx pin low-level input voltage (device disabled)		0		0.4	V
$V_{IH(ENx)}$	ENx pin high-level input voltage (device enabled)		1.1		6.5	V
$I_{SS\_CTRLx}$	SS_CTRLx pin current	$V_{INx} = 6.5\text{ V}$ $0\text{ V} \leq V_{SS\_CTRLx} \leq 6.5\text{ V}$	-0.2		0.2	$\mu\text{A}$
$V_{IT(PGx)}$	PGx pin threshold	For PGx transitioning low with falling $V_{OUTx}$ ; expressed as a percentage of $V_{OUTx(TARGET)}$	82%	88.9%	93%	
$V_{HYS(PGx)}$	PGx pin hysteresis	For PGx transitioning high with rising $V_{OUTx}$ ; expressed as a percentage of $V_{OUTx(TARGET)}$		1%		
$V_{OL(PGx)}$	PGx pin low-level output voltage	$V_{OUTx} < V_{IT(PGx)}$ , $I_{PGx} = -1\text{ mA}$ (current into device)			0.4	V
$I_{lkg(PGx)}$	PGx pin leakage current	$V_{OUTx} > V_{IT(PGx)}$ $V_{PGx} = 6.5\text{ V}$			1	$\mu\text{A}$
$I_{NR/SSx}$	NR/SSx pin charging current	$V_{NR/SSx} = \text{GND}$ $1.4\text{ V} \leq V_{INx} \leq 6.5\text{ V}$ $V_{SS\_CTRLx} = \text{GND}$	4	6.2	10	$\mu\text{A}$
		$V_{NR/SSx} = \text{GND}$ $1.4\text{ V} \leq V_{INx} \leq 6.5\text{ V}$ $V_{SS\_CTRLx} = V_{INx}$	65	100	150	
$I_{FBx}$	FBx pin leakage current	$V_{INx} = 6.5\text{ V}$ $V_{FBx} = 0.8\text{ V}$	-100		100	nA

- (1) Lowercase x indicates that the specification under consideration applies to both channel 1 and channel 2, one channel at a time.
- (2) When the device is connected to external feedback resistors at the FBx pin, external resistor tolerances are not included.
- (3) The device is not tested under conditions where  $V_{INx} > V_{OUTx} + 2.5\text{ V}$  and  $I_{OUTx} = 1\text{ A}$ ; the power dissipation is higher than the maximum rating of the package. This accuracy specification does not apply on any application condition that exceeds the power dissipation limit of the package under test.

**Electrical Characteristics (continued)**

over operating temperature range ( $T_J = -40^\circ\text{C}$  to  $+140^\circ\text{C}$ ),  $V_{INx} = 1.4\text{ V}$ ,  $V_{OUTx(TARGET)} = 0.8\text{ V}$ ,  $I_{OUTx} = 5\text{ mA}$ ,  $V_{ENx} = 1.4\text{ V}$ ,  $C_{OUTx} = 10\text{ }\mu\text{F}$ ,  $C_{NR/SSx} = 0\text{ nF}$ ,  $C_{FFx} = 0\text{ nF}$ ,  $SS\_CTRL_x = \text{GND}$ ,  $PG_x$  pin pulled up to  $V_{INx}$  with  $100\text{ k}\Omega$ , and for each channel; typical values are at  $T_J = 25^\circ\text{C}$  <sup>(1)</sup> (unless otherwise noted)

PARAMETER		TEST CONDITIONS	MIN	TYP	MAX	UNIT
PSRR	Power-supply ripple rejection	$f = 500\text{ kHz}$ $V_{INx} = 3.8\text{ V}$ $V_{OUTx} = 3.3\text{ V}$ $I_{OUTx} = 750\text{ mA}$ $C_{NR/SSx} = 10\text{ nF}$ $C_{FFx} = 10\text{ nF}$		40		dB
$V_n$	Output noise voltage	$BW = 10\text{ Hz to }100\text{ kHz}$ $V_{INx} = 1.8\text{ V}$ $V_{OUTx} = 0.8\text{ V}$ $I_{OUTx} = 1\text{ A}$ $C_{NR/SSx} = 1\text{ }\mu\text{F}$ $C_{FFx} = 100\text{ nF}$		3.8		$\mu\text{V}_{\text{RMS}}$
	Noise spectral density	$f = 10\text{ kHz}$ $V_{INx} = 1.8\text{ V}$ $V_{OUTx} = 0.8\text{ V}$ $I_{OUTx} = 1\text{ A}$ $C_{NR/SSx} = 10\text{ nF}$ $C_{FFx} = 10\text{ nF}$		11		$\text{nV}/\sqrt{\text{Hz}}$
$R_{\text{diss}}$	Output active discharge resistance	$V_{ENx} = \text{GND}$		250		$\Omega$
$T_{\text{sd}}$	Thermal shutdown temperature	Shutdown, temperature increasing		160		$^\circ\text{C}$
		Reset, temperature decreasing		140		

### 6.6 Typical Characteristics

at  $T_J = 25^\circ\text{C}$ ,  $1.4\text{ V} \leq V_{INx} < 6.5\text{ V}$ ,  $V_{INx} \geq V_{OUTx(TARGET)} + 0.3\text{ V}$ ,  $V_{OUTx} = 0.8\text{ V}$ ,  $SS\_CTRLx = \text{GND}$ ,  $I_{OUTx} = 5\text{ mA}$ ,  $V_{ENx} = 1.1\text{ V}$ ,  $C_{OUTx} = 10\text{ }\mu\text{F}$ ,  $C_{NR/SSx} = 0\text{ nF}$ ,  $C_{FFx} = 0\text{ nF}$ , PGx pin pulled up to  $V_{OUTx}$  with  $100\text{ k}\Omega$ , and  $SS\_CTRLx = \text{GND}$  (unless otherwise noted)

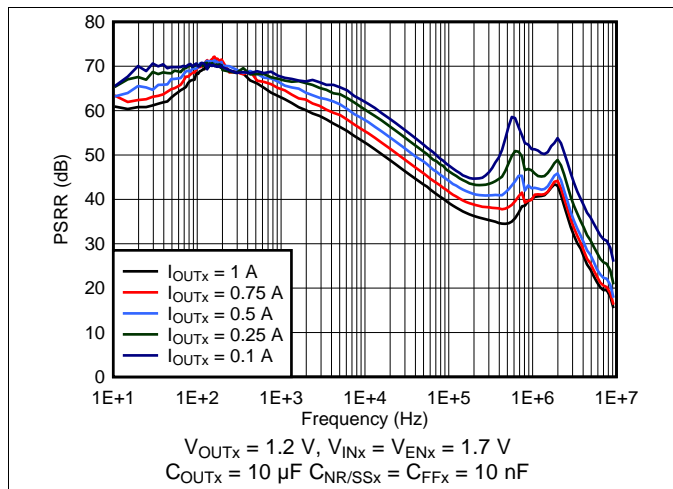

Figure 1. Power-Supply Rejection vs Output Current

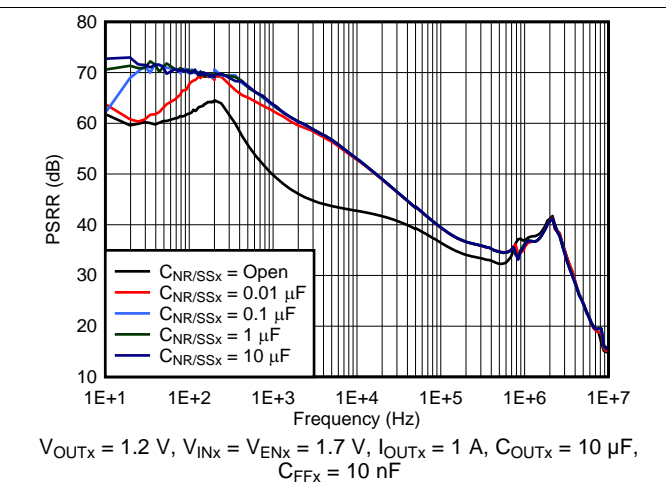

Figure 2. Power-Supply Rejection vs  $C_{NR/SSx}$

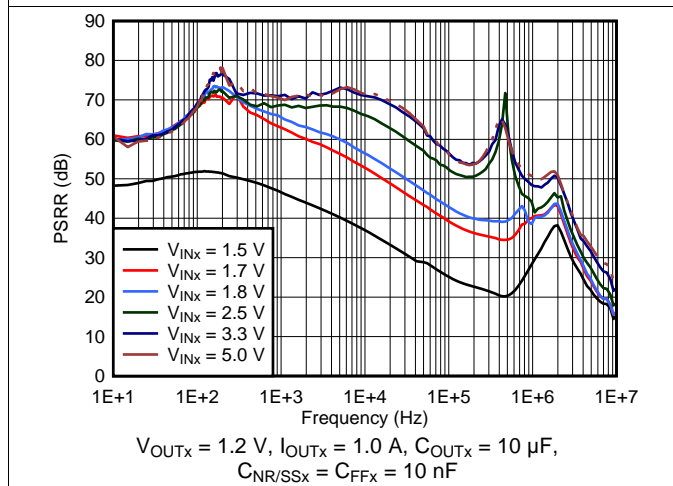

Figure 3. Power-Supply Rejection vs Input Voltage

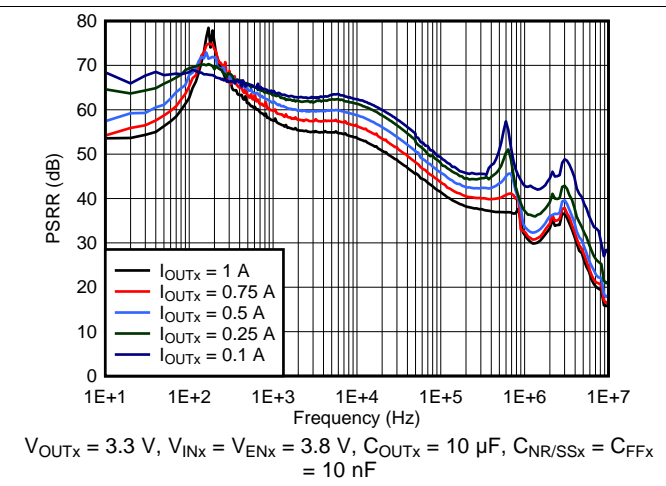

Figure 4. Power-Supply Rejection vs Output Current

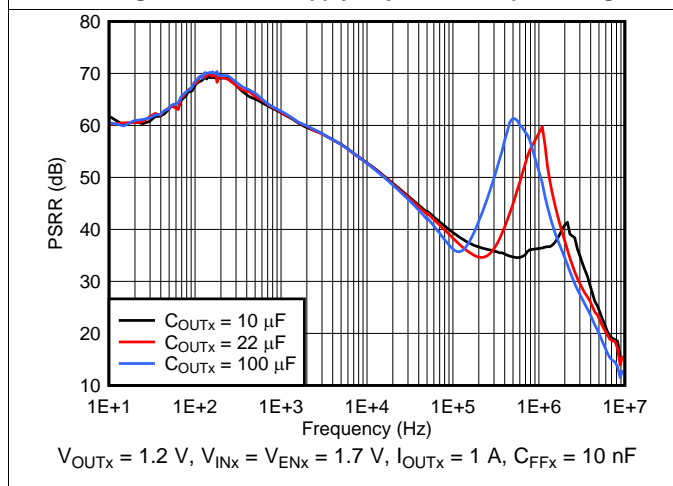

Figure 5. Power-Supply Rejection vs Output Capacitance

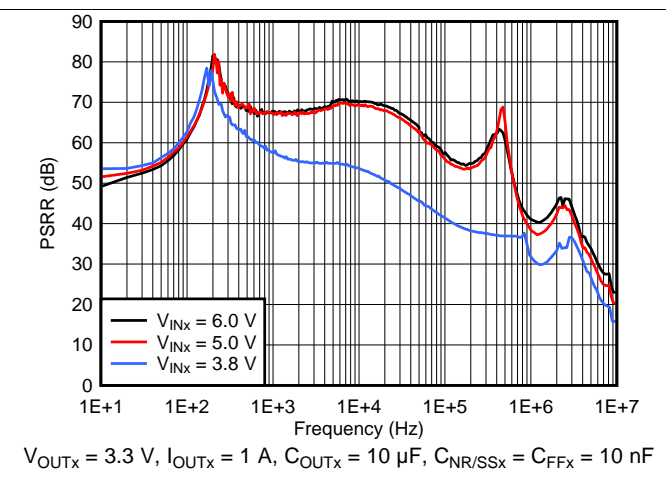

Figure 6. Power-Supply Rejection vs Input Voltage

Typical Characteristics (continued)

at  $T_J = 25^\circ\text{C}$ ,  $1.4\text{ V} \leq V_{\text{IN}x} < 6.5\text{ V}$ ,  $V_{\text{IN}x} \geq V_{\text{OUT}x(\text{TARGET})} + 0.3\text{ V}$ ,  $V_{\text{OUT}x} = 0.8\text{ V}$ ,  $\text{SS\_CTRL}x = \text{GND}$ ,  $I_{\text{OUT}x} = 5\text{ mA}$ ,  $V_{\text{EN}x} = 1.1\text{ V}$ ,  $C_{\text{OUT}x} = 10\text{ }\mu\text{F}$ ,  $C_{\text{NR}/\text{SS}x} = 0\text{ nF}$ ,  $C_{\text{FF}x} = 0\text{ nF}$ , PGx pin pulled up to  $V_{\text{OUT}x}$  with  $100\text{ k}\Omega$ , and  $\text{SS\_CTRL}x = \text{GND}$  (unless otherwise noted)

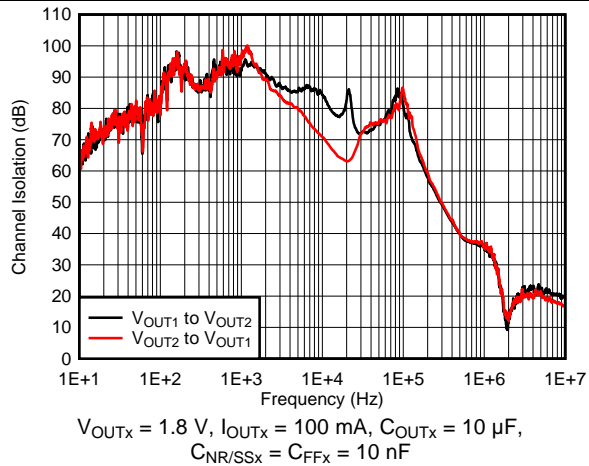

Figure 7. Channel-to-Channel Output Voltage Isolation vs Frequency

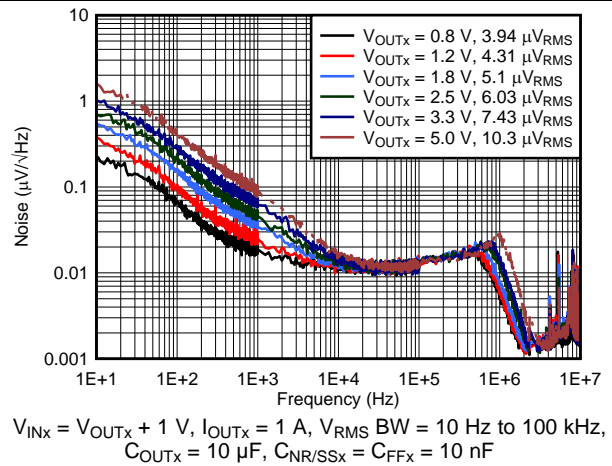

Figure 8. Spectral Noise Density vs Output Voltage

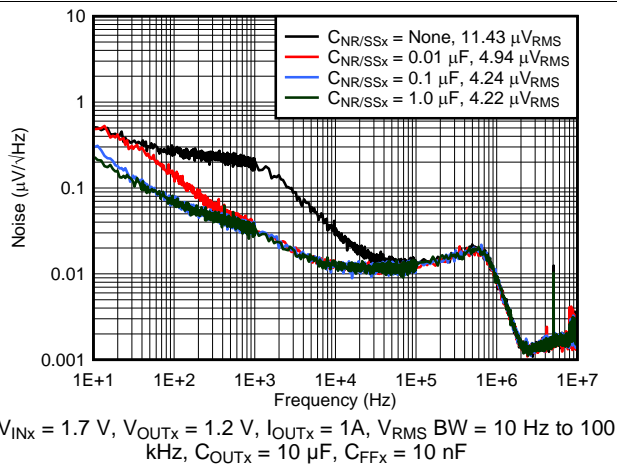

Figure 9. Spectral Noise Density vs  $C_{\text{NR}/\text{SS}x}$

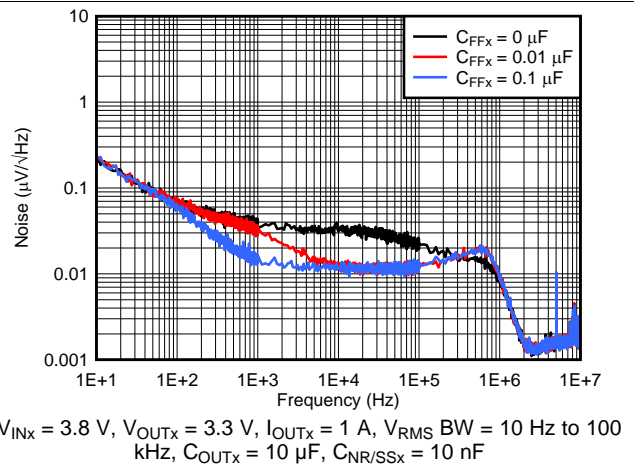

Figure 10. Spectral Noise Density vs  $C_{\text{FF}x}$

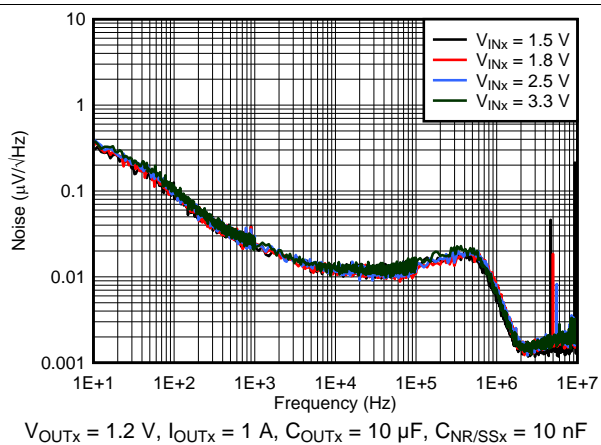

Figure 11. Spectral Noise Density vs  $V_{\text{IN}x}$

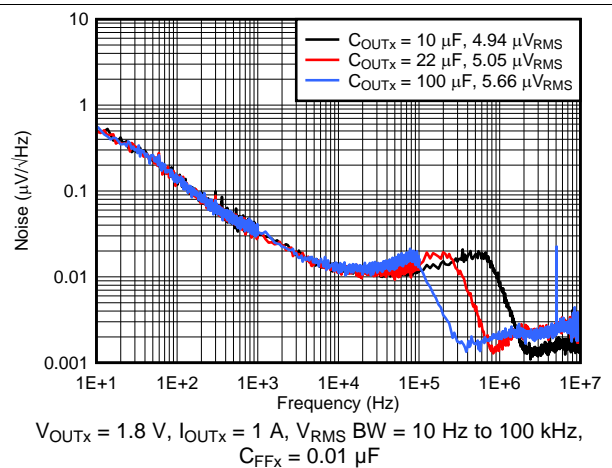
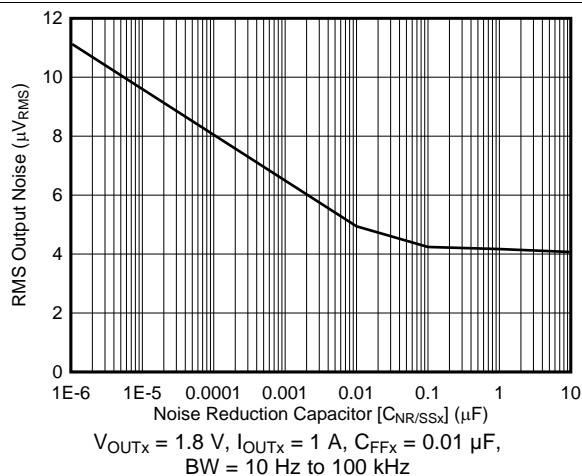

Figure 12. Spectral Noise Density vs  $C_{\text{OUT}x}$



**Typical Characteristics (continued)**

at  $T_J = 25^\circ\text{C}$ ,  $1.4\text{ V} \leq V_{\text{INX}} < 6.5\text{ V}$ ,  $V_{\text{INX}} \geq V_{\text{OUTX(TARGET)}} + 0.3\text{ V}$ ,  $V_{\text{OUTX}} = 0.8\text{ V}$ ,  $\text{SS\_CTRLX} = \text{GND}$ ,  $I_{\text{OUTX}} = 5\text{ mA}$ ,  $V_{\text{ENX}} = 1.1\text{ V}$ ,  $C_{\text{OUTX}} = 10\text{ }\mu\text{F}$ ,  $C_{\text{NR/SSx}} = 0\text{ nF}$ ,  $C_{\text{FFx}} = 0\text{ nF}$ , PGx pin pulled up to  $V_{\text{OUTX}}$  with  $100\text{ k}\Omega$ , and  $\text{SS\_CTRLX} = \text{GND}$  (unless otherwise noted)



**Figure 13. RMS Output Noise vs  $C_{\text{NR/SSx}}$**

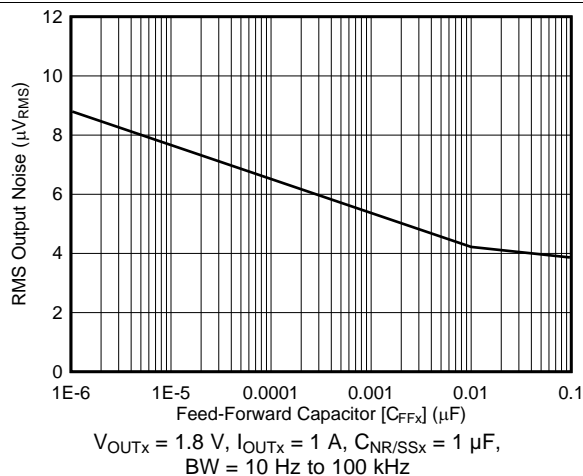

**Figure 14. RMS Output Noise vs  $C_{\text{FFx}}$**

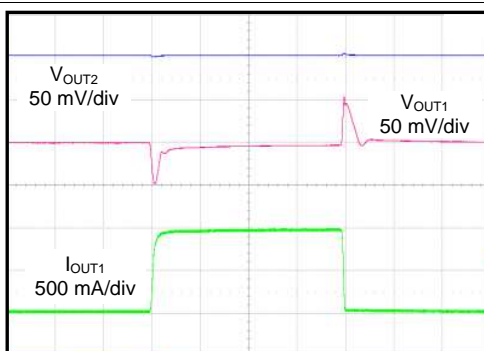

**Figure 15. Load Transient Response**

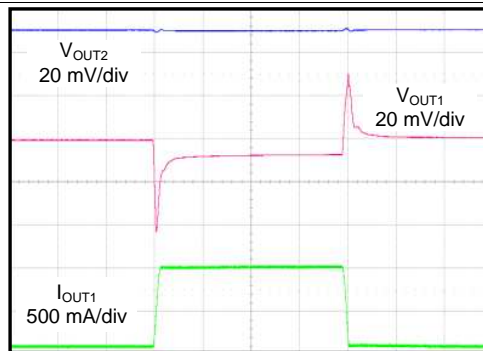

**Figure 16. Load Transient Response ()**

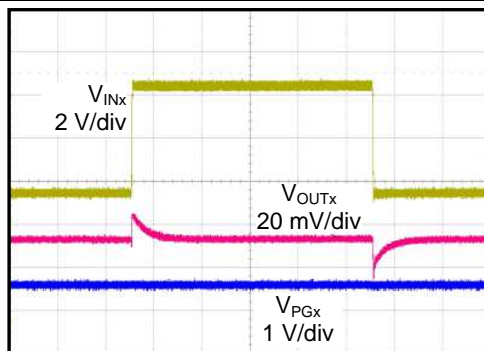

**Figure 17. Line Transient**

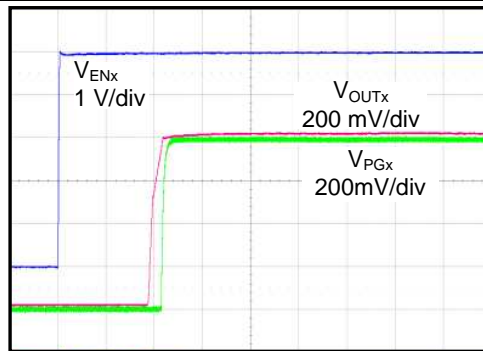

**Figure 18. Start-Up**

Typical Characteristics (continued)

at  $T_J = 25^\circ\text{C}$ ,  $1.4\text{ V} \leq V_{\text{INX}} < 6.5\text{ V}$ ,  $V_{\text{INX}} \geq V_{\text{OUTX(TARGET)}} + 0.3\text{ V}$ ,  $V_{\text{OUTX}} = 0.8\text{ V}$ ,  $\text{SS\_CTRLX} = \text{GND}$ ,  $I_{\text{OUTX}} = 5\text{ mA}$ ,  $V_{\text{ENX}} = 1.1\text{ V}$ ,  $C_{\text{OUTX}} = 10\text{ }\mu\text{F}$ ,  $C_{\text{NR/SSX}} = 0\text{ nF}$ ,  $C_{\text{FFX}} = 0\text{ nF}$ , PGx pin pulled up to  $V_{\text{OUTX}}$  with  $100\text{ k}\Omega$ , and  $\text{SS\_CTRLX} = \text{GND}$  (unless otherwise noted)

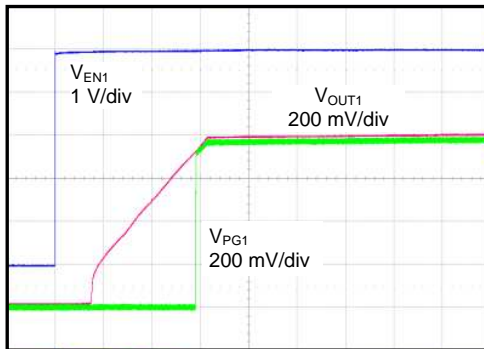

Time (500  $\mu\text{s/div}$ )  
 $V_{\text{INX}} = 1.4\text{ V}$ ,  $\text{SS\_CTRLX} = \text{GND}$ ,  $C_{\text{NR/SSX}} = 10\text{ nF}$

Figure 19. Start-Up

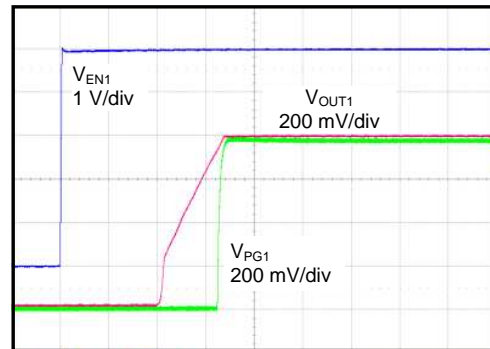

Time (50  $\mu\text{s/div}$ )  
 $V_{\text{INX}} = 1.4\text{ V}$ ,  $\text{SS\_CTRLX} = V_{\text{INX}}$ ,  $C_{\text{NR/SSX}} = 10\text{ nF}$

Figure 20. Start-Up

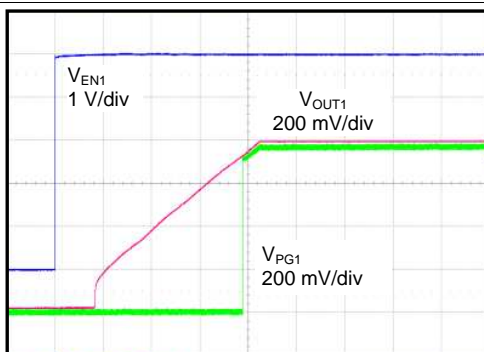

Time (2 ms/div)  
 $V_{\text{INX}} = 1.4\text{ V}$ ,  $\text{SS\_CTRLX} = V_{\text{INX}}$ ,  $C_{\text{NR/SSX}} = 1\text{ }\mu\text{F}$

Figure 21. Start-Up

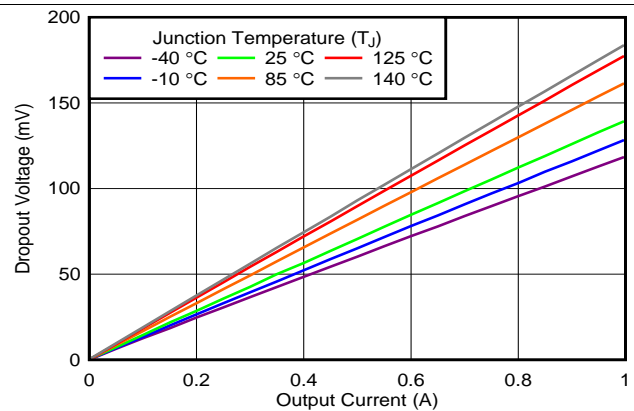

$V_{\text{INX}} = 5.5\text{ V}$ ,  $V_{\text{FB}} = 95\% \times V_{\text{FB(nom)}}$

Figure 22. Dropout Voltage vs Output Current

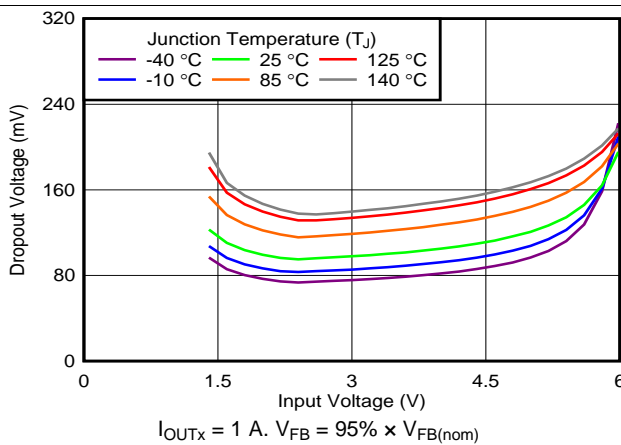

$I_{\text{OUTX}} = 1\text{ A}$ ,  $V_{\text{FB}} = 95\% \times V_{\text{FB(nom)}}$

Figure 23. Dropout Voltage vs Input Voltage

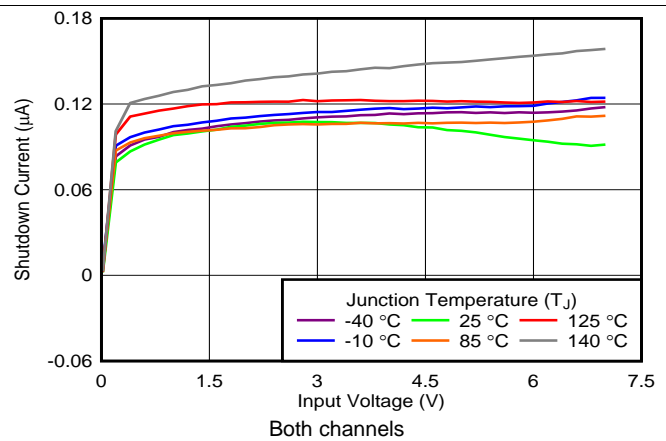

Both channels

Figure 24. Shutdown Current vs Input Voltage

### Typical Characteristics (continued)

at  $T_J = 25^\circ\text{C}$ ,  $1.4\text{ V} \leq V_{\text{INx}} < 6.5\text{ V}$ ,  $V_{\text{INx}} \geq V_{\text{OUTx(TARGET)}} + 0.3\text{ V}$ ,  $V_{\text{OUTx}} = 0.8\text{ V}$ ,  $\text{SS\_CTRLx} = \text{GND}$ ,  $I_{\text{OUTx}} = 5\text{ mA}$ ,  $V_{\text{ENx}} = 1.1\text{ V}$ ,  $C_{\text{OUTx}} = 10\text{ }\mu\text{F}$ ,  $C_{\text{NR/SSx}} = 0\text{ nF}$ ,  $C_{\text{FFx}} = 0\text{ nF}$ , PGx pin pulled up to  $V_{\text{OUTx}}$  with  $100\text{ k}\Omega$ , and  $\text{SS\_CTRLx} = \text{GND}$  (unless otherwise noted)

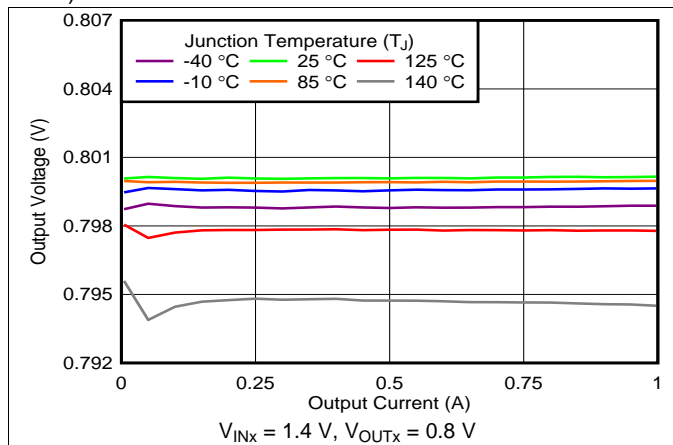

Figure 25. Load Regulation

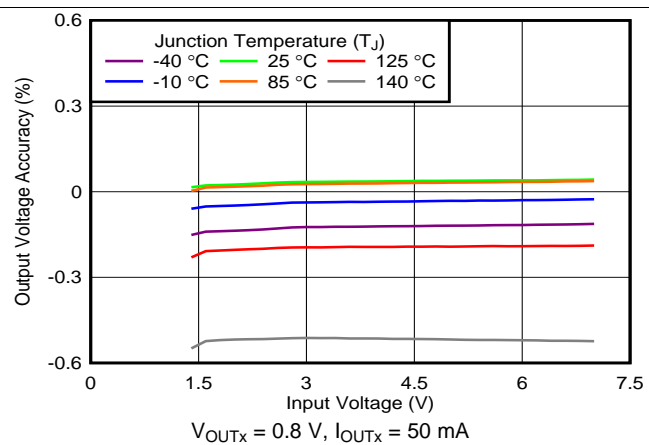

Figure 26. Line Regulation

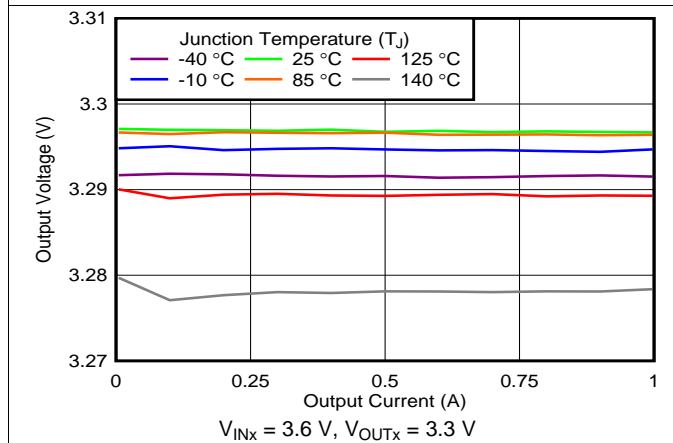

Figure 27. Load Regulation

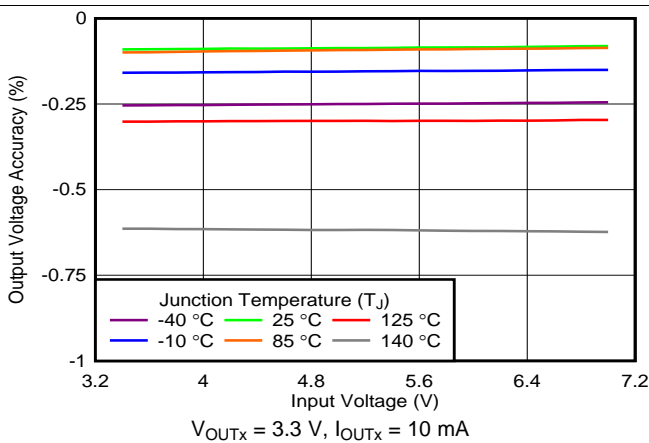

Figure 28. Line Regulation

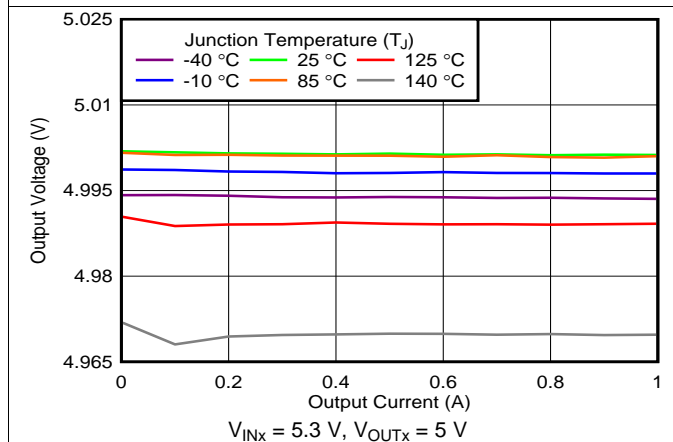

Figure 29. Load Regulation

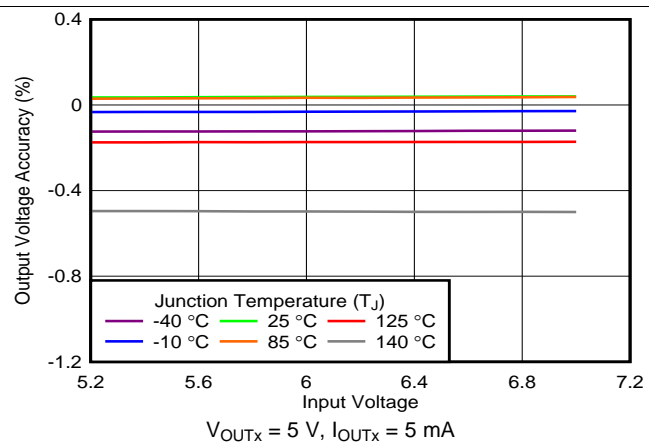

Figure 30. Line Regulation

### Typical Characteristics (continued)

at  $T_J = 25^\circ\text{C}$ ,  $1.4\text{ V} \leq V_{\text{INx}} < 6.5\text{ V}$ ,  $V_{\text{INx}} \geq V_{\text{OUTx(TARGET)}} + 0.3\text{ V}$ ,  $V_{\text{OUTx}} = 0.8\text{ V}$ ,  $\text{SS\_CTRLx} = \text{GND}$ ,  $I_{\text{OUTx}} = 5\text{ mA}$ ,  $V_{\text{ENx}} = 1.1\text{ V}$ ,  $C_{\text{OUTx}} = 10\ \mu\text{F}$ ,  $C_{\text{NR/SSx}} = 0\text{ nF}$ ,  $C_{\text{FFx}} = 0\text{ nF}$ , PGx pin pulled up to  $V_{\text{OUTx}}$  with  $100\text{ k}\Omega$ , and  $\text{SS\_CTRLx} = \text{GND}$  (unless otherwise noted)

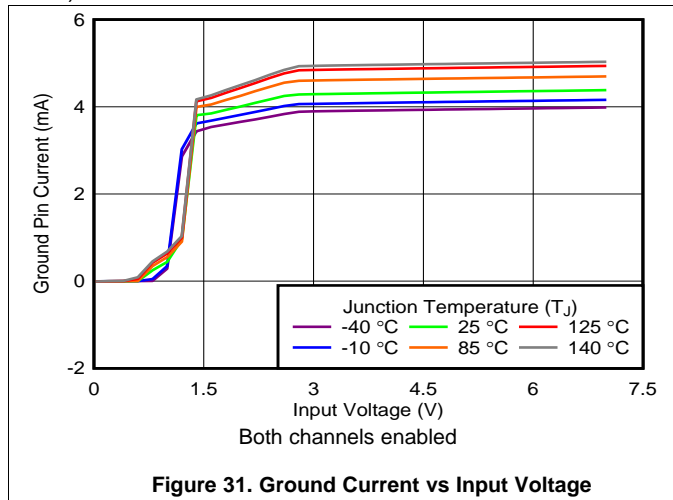

Figure 31. Ground Current vs Input Voltage

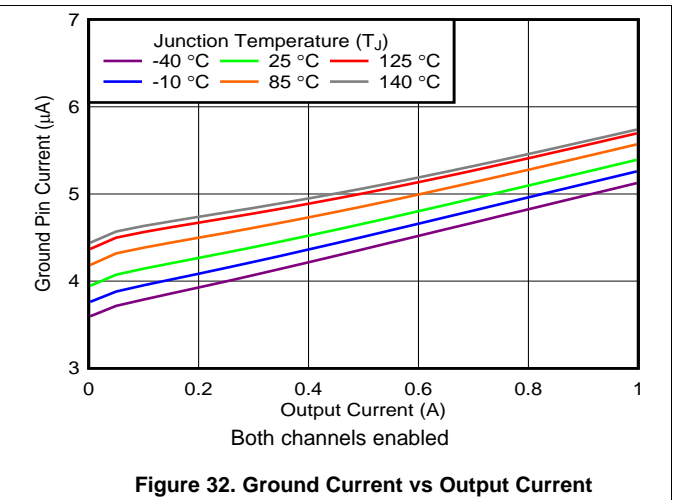

Figure 32. Ground Current vs Output Current

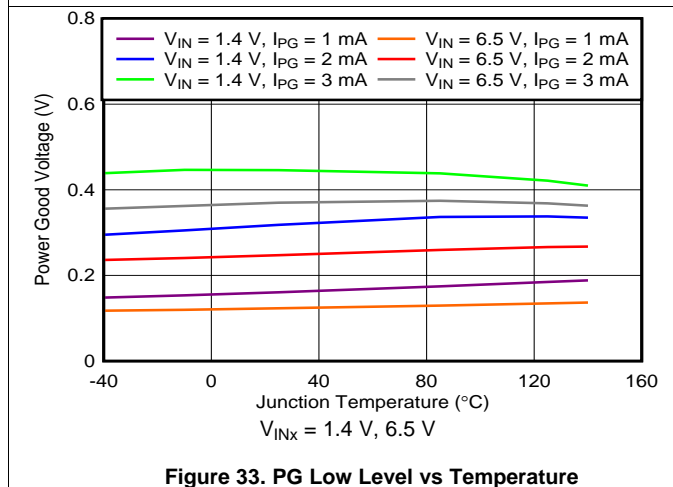

Figure 33. PG Low Level vs Temperature

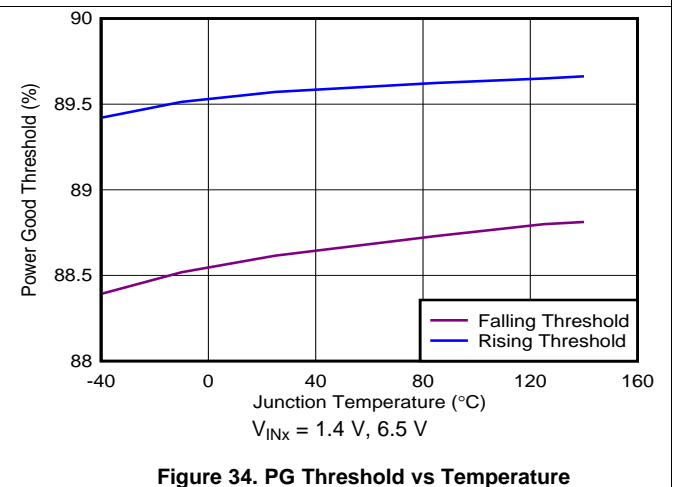

Figure 34. PG Threshold vs Temperature

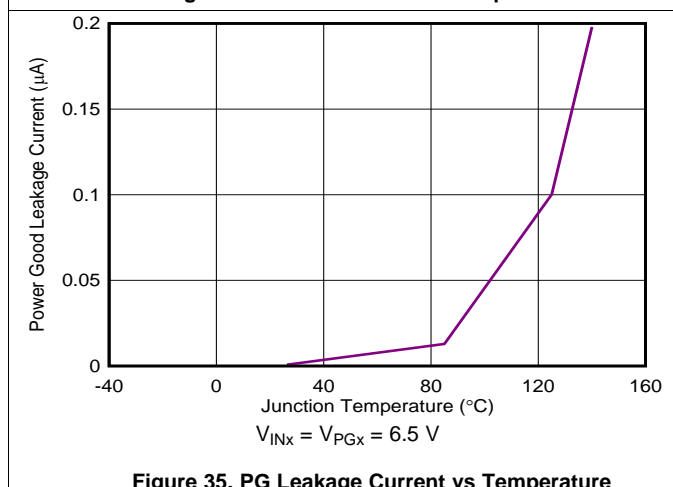

Figure 35. PG Leakage Current vs Temperature

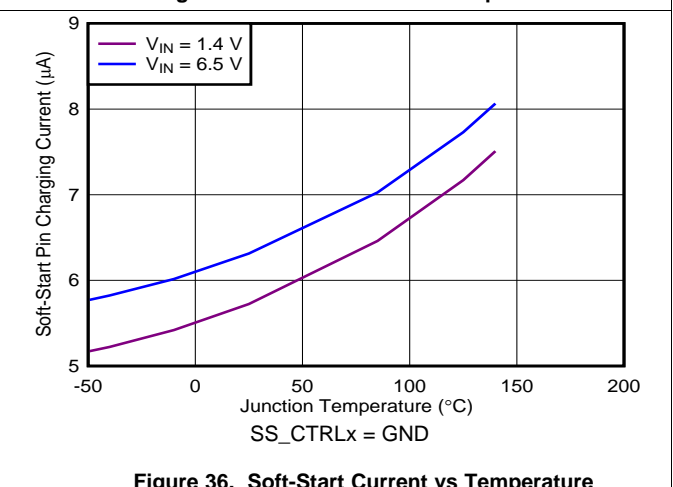
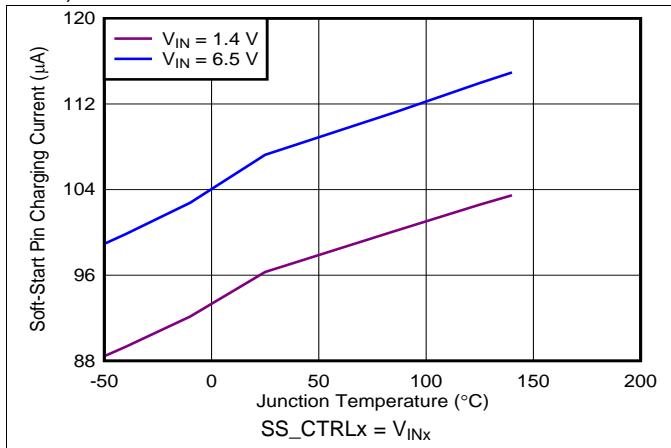

Figure 36. Soft-Start Current vs Temperature

**Typical Characteristics (continued)**

at  $T_J = 25^\circ\text{C}$ ,  $1.4\text{ V} \leq V_{INx} < 6.5\text{ V}$ ,  $V_{INx} \geq V_{OUTx(TARGET)} + 0.3\text{ V}$ ,  $V_{OUTx} = 0.8\text{ V}$ ,  $SS\_CTRLx = \text{GND}$ ,  $I_{OUTx} = 5\text{ mA}$ ,  $V_{ENx} = 1.1\text{ V}$ ,  $C_{OUTx} = 10\ \mu\text{F}$ ,  $C_{NR/SSx} = 0\text{ nF}$ ,  $C_{FFx} = 0\text{ nF}$ , PGx pin pulled up to  $V_{OUTx}$  with  $100\text{ k}\Omega$ , and  $SS\_CTRLx = \text{GND}$  (unless otherwise noted)



**Figure 37. Soft-Start Current vs Temperature**

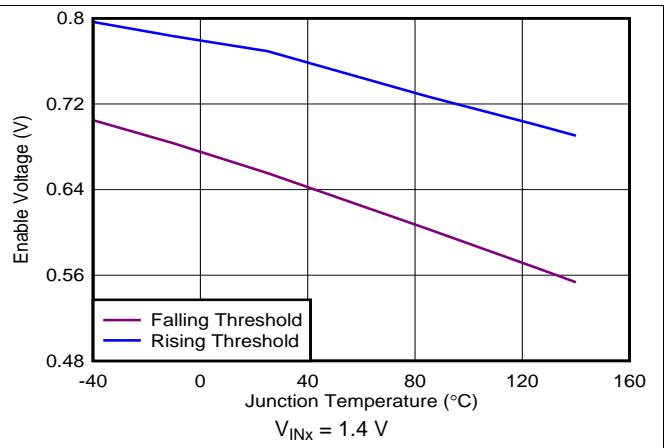

**Figure 38. Enable Threshold vs Temperature**

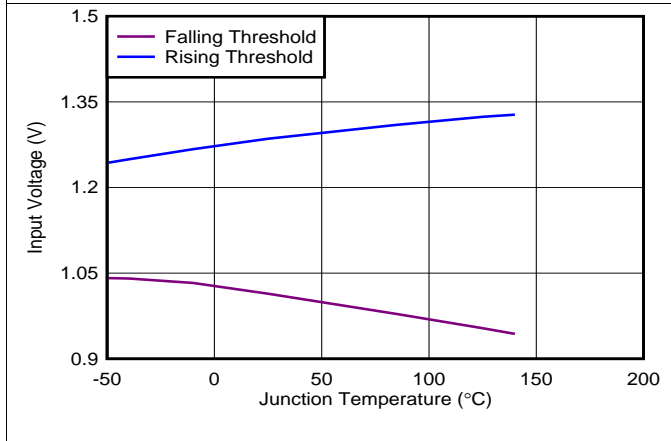

**Figure 39. Input UVLO Threshold vs Temperature**

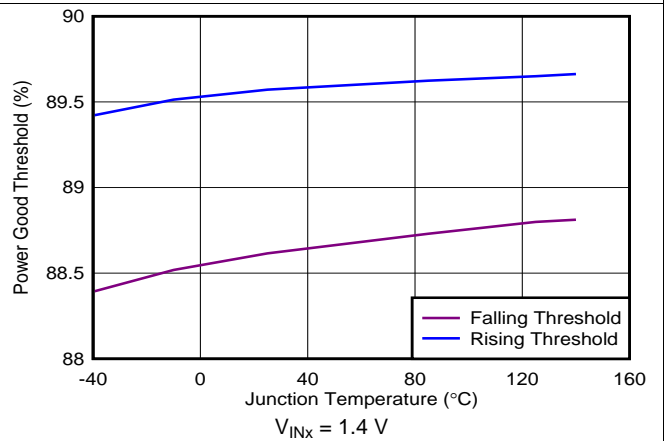

**Figure 40. PG Threshold vs Temperature**

## 7 Detailed Description

### 7.1 Overview

The TPS7A88-Q1 is a monolithic, dual-channel, low-dropout (LDO) regulator. Each channel is low-noise, high-PSRR, and capable of sourcing a 1-A load with 250 mV of maximum dropout. These features make the device a robust solution to solve challenging problems in generating a clean, accurate power supply.

The various features for each of the TPS7A88-Q1 fully independent LDOs simplify using the device in a variety of applications. These features are organized into three categories as listed in [Table 1](#).

**Table 1. Features**

VOLTAGE REGULATION	SYSTEM START-UP	INTERNAL PROTECTION
High accuracy	Programmable soft start	Foldback current limit
Low-noise, high-PSRR output	Sequencing controls	Thermal shutdown
Fast transient response	Power-good output	

### 7.2 Functional Block Diagram

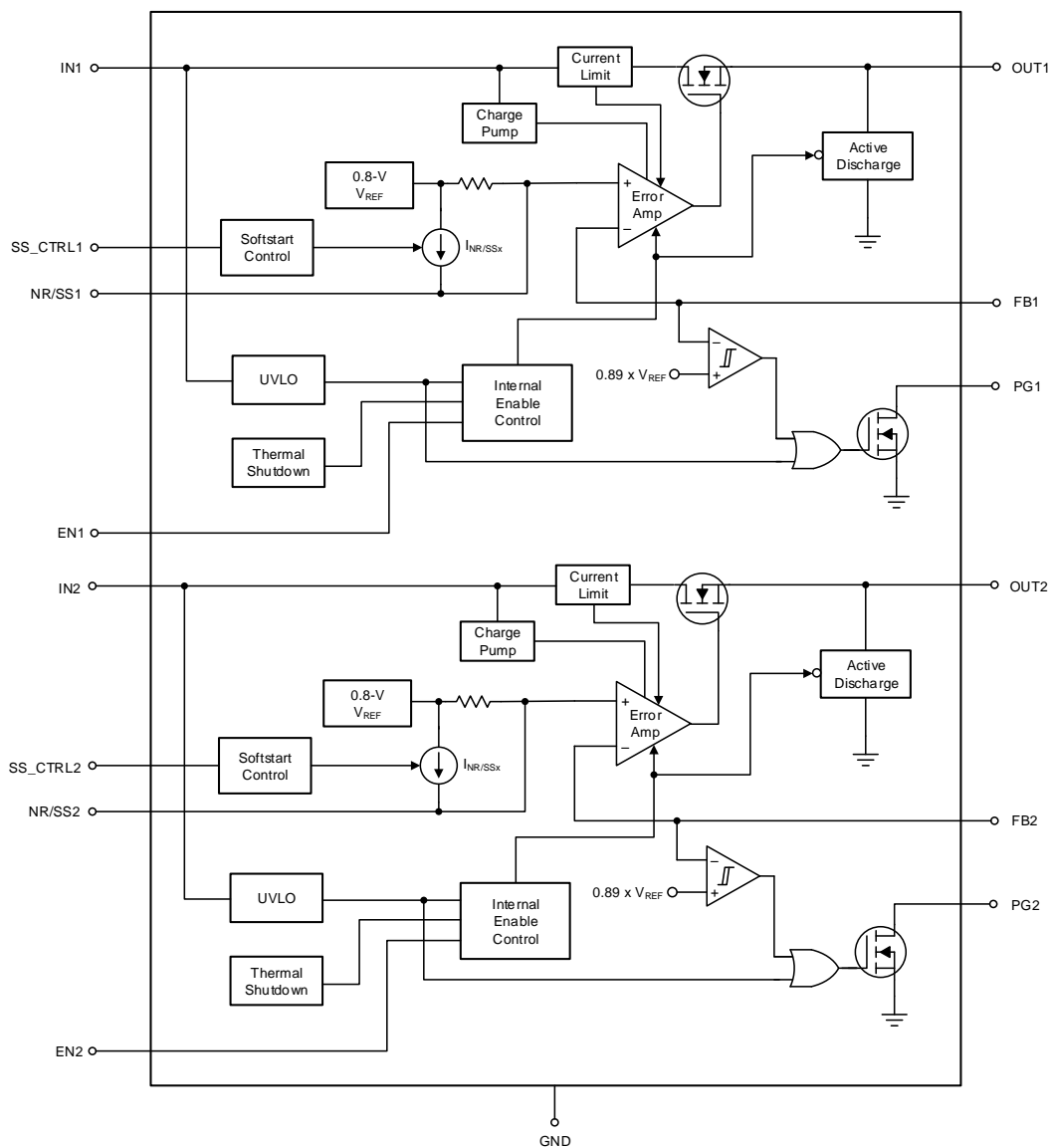

## 7.3 Feature Description

### 7.3.1 Voltage Regulation Features

#### 7.3.1.1 DC Regulation

An LDO functions as a buffered op-amp in which the input signal is the internal reference voltage ( $V_{REF}$ ), as shown in Figure 41.  $V_{REF}$  is designed to have a very low-bandwidth at the input to the error amplifier through the use of a low-pass filter ( $V_{NR/SSx}$ ).

The reference can be considered as a pure DC input signal. The low output impedance of an LDO comes from the combination of the output capacitor and pass element. The pass element also presents a high input impedance to the source voltage when operating as a current source. A positive LDO can only source current because of the class-B architecture.

This device achieves a maximum of 1% output voltage accuracy primarily because of the high-precision band-gap voltage ( $V_{BG}$ ) that creates  $V_{REF}$ . The low dropout voltage ( $V_{DO}$ ) reduces the thermal power dissipation required by the device to regulate the output voltage at a given current level, which improves system efficiency. Combined, these features help make this device a good approximation of an ideal voltage source.

This device replaces two stand-alone power-supplies and provides load-to-load isolation. The LDOs can be put in series (cascaded) to achieve even higher PSRR by connecting the output of one channel to the input of the other channel.

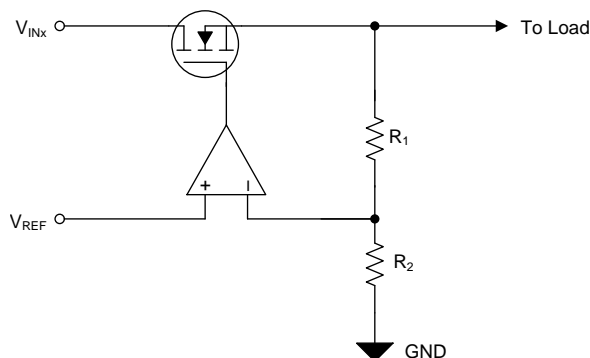

NOTE:  $V_{OUTx} = V_{REF} \times (1 + R_{1x} / R_{2x})$ .

Figure 41. Simplified Regulation Circuit

#### 7.3.1.2 AC and Transient Response

Each LDO responds quickly to a transient (large-signal response) on the input supply (line transient) or the output current (load transient) resulting from the LDO high-input impedance and low output-impedance across frequency. This same capability also means that each LDO has a high power-supply rejection-ratio (PSRR) and, when coupled with a low internal noise-floor ( $V_n$ ), the LDO approximates an ideal power supply in AC (small-signal) and large-signal conditions.

The performance and internal layout of the device minimizes the coupling of noise from one channel to the other channel (crosstalk). Good printed circuit board (PCB) layout minimizes the crosstalk.

The choice of external component values optimizes the small- and large-signal response. The NR/SSx capacitor ( $C_{NR/SSx}$ ) and feedforward capacitor ( $C_{FFx}$ ) easily reduce the device noise floor and improve PSRR. See [Optimizing Noise and PSRR](#) for more information on optimizing the noise and PSRR performance.

### 7.3.2 System Start-Up Features

In many different applications, the power-supply output must turn on within a specific window of time to either ensure proper operation of the load or to minimize the loading on the input supply or other sequencing requirements. Each LDO start-up is well-controlled and user-adjustable, solving the demanding requirements faced by many power-supply design engineers in a simple fashion.

## Feature Description (continued)

### 7.3.2.1 Programmable Soft-Start (NR/SSx)

Soft start directly controls the output start-up time and indirectly controls the output current during start-up (in-rush current).

The external capacitor at the NR/SSx pin ( $C_{NR/SSx}$ ) sets the output start-up time by setting the rise time of the internal reference ( $V_{NR/SSx}$ ), as shown in Figure 42. SS\_CTRLx provides additional control over the rise time of the internal reference by enabling control over the charging current ( $I_{NR/SSx}$ ) for  $C_{NR/SSx}$ . The voltage at the SS\_CTRLx pin ( $V_{SS\_CTRLx}$ ) must be connected to ground (GND) or  $V_{INx}$ .

Note that if  $C_{NR/SSx} = 0$  nF and the SS\_CTRLx pin is connected to  $V_{INx}$ , then the output voltage overshoots during start-up.

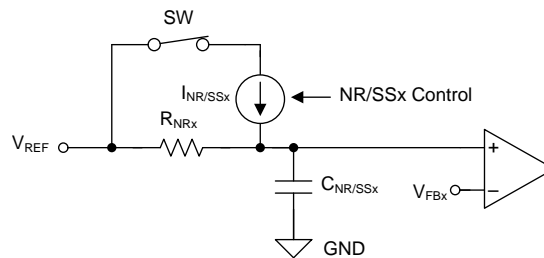

Figure 42. Simplified Soft-Start Circuit

### 7.3.2.2 Sequencing

Controlling when a single power supply turns on can be difficult in a power distribution network (PDN) because of the high power levels inherent in a PDN and the variations between the supplies. The specific channel enable circuit (ENx) and undervoltage lockout circuit (UVLOx) set the turnon and turnoff time shown in Figure 43 and Table 2.

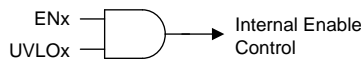

Figure 43. Simplified Turn-On Control

Table 2. Sequencing Functionality Table

INPUT VOLTAGE	ENABLE STATUS	LDO STATUS	ACTIVE DISCHARGE	POWER-GOOD
$V_{INx} \geq V_{UVLOx}$	ENx = 1	On	Off	PGx = 1 when $V_{OUTx} \geq V_{IT(PGx)}$
	ENx = 0	Off	On	PGx = 0
$V_{INx} < V_{UVLOx} - V_{HYS}$	ENx = don't care	Off	On <sup>(1)</sup>	PGx = 0

(1) The active discharge remains on as long as  $V_{INx}$  provides enough headroom for the discharge circuit to function.

#### 7.3.2.2.1 Enable (ENx)

The enable signal ( $V_{ENx}$ ) is an active-high digital control that enables the LDO when the enable voltage is past the rising threshold ( $V_{ENx} \geq V_{IH(ENx)}$ ) and disables the LDO when the enable voltage is below the falling threshold ( $V_{ENx} \leq V_{IL(ENx)}$ ). The exact enable threshold is between  $V_{IH(ENx)}$  and  $V_{IL(ENx)}$  because ENx is a digital control. In applications that do not use the enable control, connect ENx to  $V_{INx}$ .



### 7.3.2.2.2 Undervoltage Lockout (UVLOx) Control

The UVLOx circuit responds quickly to glitches on  $V_{INx}$  and attempts to disable the output of the device if these rails collapse.

As a result of the fast response time of the input supply UVLOx circuit, fast and short line transients well below the input supply UVLOx falling threshold (brownouts) can cause momentary glitches during the edges of the transient. These glitches are typical in most LDOs. The local input capacitance prevents severe brownouts in most applications; see [Undervoltage Lockout \(UVLOx\) Control](#) for more details.

### 7.3.2.2.3 Active Discharge

When  $ENx$  or UVLOx is low, the device connects a resistor of several hundred ohms from  $V_{OUTx}$  to GND, discharging the output capacitance.

Do not rely on the active discharge circuit for discharging large output capacitors when the input voltage drops below the targeted output voltage. Current flows from the output to the input (reverse current) when  $V_{OUTx} > V_{INx}$ , which can cause damage to the device (when  $V_{OUTx} > V_{INx} + 0.3\text{ V}$ ); see [Reverse Current Protection](#) for more details.

### 7.3.2.3 Power-Good Output (PGx)

The PGx signal provides an easy solution to meet demanding sequencing requirements because PGx signals when the output nears the nominal value. PGx can be used to signal other devices in a system when the output voltage is near, at, or above the set output voltage ( $V_{OUTx(Target)}$ ). [Figure 44](#) shows a simplified schematic.

The PGx signal is an open-drain digital output that requires a pullup resistor to a voltage source and is active high. The power-good circuit sets the PGx pin into a high-impedance state to indicate that the power is good.

Using a large feedforward capacitor ( $C_{FFx}$ ) delays the output voltage and, because the power-good circuit monitors the FBx pin, the PGx signal can indicate a false positive. A simple solution to this scenario is to use an external voltage detector device, such as the [TPS3780](#); see [Feedforward Capacitor \( \$C\_{FFx}\$ \)](#) for more information.

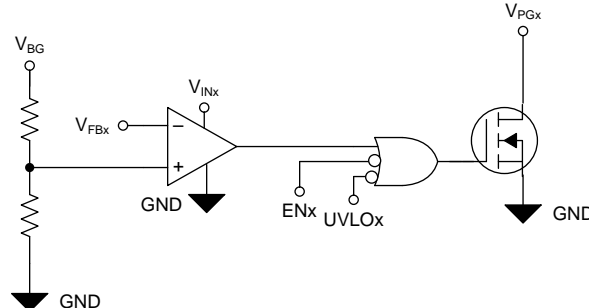

Figure 44. Simplified PGx Circuit

### 7.3.3 Internal Protection Features

In many applications, fault events can damage devices in the system. Short-circuits and excessive heat are the most common fault events for power supplies. The TPS7A88-Q1 implements circuitry for each LDO to protect the device and the load during these events. Continuously operating in these fault conditions or above a junction temperature outside of the specified operating range is not recommended because it reduces the long-term reliability of the device.

#### 7.3.3.1 Foldback Current Limit ( $I_{CLx}$ )

The internal current limit circuit protects the LDO against short-circuit and excessive load current conditions. The output current decreases (folds back) when the output voltage falls to better protect the device. Each channel features an independent current limit circuit.

#### 7.3.3.2 Thermal Protection ( $T_{sdx}$ )

The thermal shutdown circuit protects the LDO against excessive heat in the system, either resulting from current limit or high ambient temperature. Each channel features an independent thermal shutdown circuit.

The output of the LDO turns off when the LDO temperature (junction temperature,  $T_J$ ) exceeds the rising thermal shutdown temperature ( $T_{sdx}$ ). The output turns on again after  $T_J$  decreases below the falling thermal shutdown temperature ( $T_{sdx}$ ).

A high power dissipation across the device, combined with a high ambient temperature ( $T_A$ ), can cause  $T_J$  to be greater than or equal to  $T_{sdx}$ , triggering the thermal shutdown and causing the output to fall to 0 V. The LDO can cycle on and off when thermal shutdown is reached under these conditions.

## 7.4 Device Functional Modes

Table 3 provides a comparison between the regulation and disabled operation.

**Table 3. Device Functional Modes Comparison**

OPERATING MODE	PARAMETER			
	$V_{INx}$	$ENx$	$I_{OUTx}$	$T_J$
Regulation <sup>(1)</sup>	$V_{INx} > V_{OUTx(nom)} + V_{DO}$	$V_{ENx} > V_{IH(ENx)}$	$I_{OUTx} < I_{CLx}$	$T_J < T_{sd}$
Disabled <sup>(2)</sup>	$V_{INx} < V_{UVLOx}$	$V_{ENx} < V_{IL(ENx)}$	—	$T_J > T_{sd}$

(1) All table conditions must be met.

(2) The device is disabled when any condition is met.

#### 7.4.1 Regulation

The device regulates the output to the targeted output voltage when all the conditions in Table 3 are met.

#### 7.4.2 Disabled

When disabled, the pass device is turned off, the internal circuits are shut down, and the output voltage is actively discharged to ground by an internal resistor from the output to ground.

## 8 Application and Implementation

### NOTE

Information in the following applications sections is not part of the TI component specification, and TI does not warrant its accuracy or completeness. TI's customers are responsible for determining suitability of components for their purposes. Customers should validate and test their design implementation to confirm system functionality.

### 8.1 Application Information

Successfully implementing an LDO in an application depends on the application requirements. This section discusses key device features and how to best implement them to achieve a reliable design.

#### 8.1.1 External Component Selection

##### 8.1.1.1 Setting the Output Voltage (Adjustable Operation)

Each LDO resistor feedback network sets the output voltage as (Figure 45 shows) with an output voltage range of 0.8 V to 5.15 V.

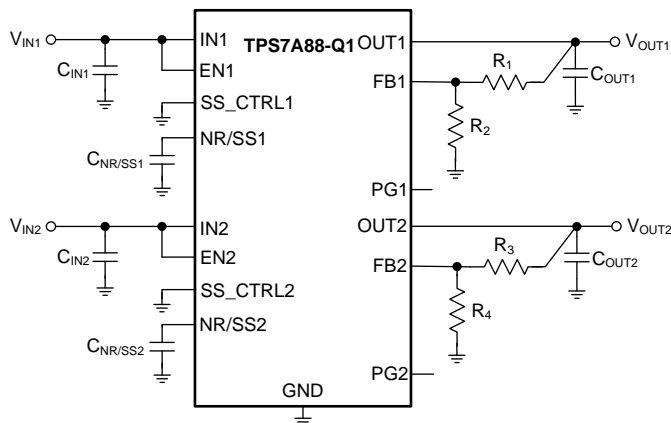

Copyright © 2017, Texas Instruments Incorporated

Figure 45. Adjustable Operation

Equation 1 relates the values  $R_{1x}$  and  $R_{2x}$  to  $V_{OUTx(Target)}$  and  $V_{FBx}$ . Equation 1 is a rearranged version of Equation 2 which simplifies the feedback resistor calculation. The current through the feedback network must be equal to or greater than 5  $\mu\text{A}$  for optimum noise performance and accuracy, as shown in Equation 3.

$$V_{OUTx} = V_{FBx} \times (1 + R_{1x} / R_{2x}) \quad (1)$$

$$R_{1x} = (V_{OUTx} / V_{FBx} - 1) \times R_{2x} \quad (2)$$

$$R_{2x} < V_{REF} / 5 \mu\text{A} \quad (3)$$

The input bias current into the error amplifier (feedback pin current,  $I_{FBx}$ ) and tighter tolerance resistors must be taken into account for optimizing the output voltage accuracy.

## Application Information (continued)

Table 4 lists the resistor combinations for several common output voltages using commercially-available, 1% tolerance resistors.

**Table 4. Recommended Feedback Resistor Values**

TARGETED OUTPUT VOLTAGE (V)	FEEDBACK RESISTOR VALUES <sup>(1)</sup>		CALCULATED OUTPUT VOLTAGE (V)
	R <sub>1x</sub> (kΩ)	R <sub>2x</sub> (kΩ)	
0.8	Short	Open	0.8
0.9	1.37	11	0.9
0.95	1.91	10.2	0.95
1	2.55	10.2	1
1.05	3.32	10.7	1.048
1.1	3.57	9.53	1.1
1.15	4.64	10.7	1.147
1.2	5.49	11	1.199
1.35	6.98	10.2	1.347
1.5	9.31	10.7	1.496
1.8	13.7	11	1.796
1.9	14.7	10.7	1.899
2.5	22.6	10.7	2.49
2.85	27.4	10.7	2.849
3	29.4	10.7	2.998
3.3	33.2	10.7	3.282
3.6	35.7	10.2	3.6
4.5	44.2	9.53	4.51
5	56.2	10.7	5.002

(1) R<sub>1x</sub> is connected from OUT<sub>x</sub> to FB<sub>x</sub>; R<sub>2x</sub> is connected from FB<sub>x</sub> to GND; see [Figure 45](#).

### 8.1.1.2 Capacitor Recommendations

The device is designed to be stable using low equivalent series resistance (ESR) ceramic capacitors at the input and output pins. Multilayer ceramic capacitors have become the industry standard for these types of applications and are recommended, but must be used with good judgment. Ceramic capacitors that employ X7R-, X5R-, and COG-rated dielectric materials provide relatively good capacitive stability across temperature, whereas the use of Y5V-rated capacitors is not recommended because of large variations in capacitance.

Regardless of the selected ceramic capacitor type, ceramic capacitance varies with operating voltage and temperature. As a rule of thumb, derate ceramic capacitors by at least 50%. The input and output capacitors recommended herein account for an effective capacitance derating of approximately 50%, but at higher V<sub>INx</sub> and V<sub>OUTx</sub> conditions (that is, V<sub>INx</sub> = 5.5 V to V<sub>OUTx</sub> = 5 V) the derating can be greater than 50% and must be taken into consideration.

### 8.1.1.3 Input and Output Capacitor (C<sub>INx</sub> and C<sub>OUTx</sub>)

The device is designed and characterized for operation with ceramic capacitors of 10 μF or greater (5 μF or greater of effective capacitance) at each input and output. Locate the input and output capacitors as near as practical to the respective input and output pins to minimize the trace inductance from the capacitor to the device.

### 8.1.1.4 Feedforward Capacitor ( $C_{FFx}$ )

Although a feedforward capacitor ( $C_{FFx}$ ) from the FBx pin to the OUTx pin is not required to achieve stability, a 10-nF external  $C_{FFx}$  optimizes the transient, noise, and PSRR performance. A higher capacitance  $C_{FFx}$  can be used; however, the start-up time is longer and the power-good signal can incorrectly indicate that the output voltage is settled. The maximum recommended value is 100 nF.

To ensure proper PGx functionality, the time constant defined by  $C_{NR/SSx}$  must be greater than or equal to the time constant from  $C_{FFx}$ . For a detailed description, see [Pros and Cons of Using a Feedforward Capacitor with a Low Dropout Regulator](#).

### 8.1.1.5 Noise-Reduction and Soft-Start Capacitor ( $C_{NR/SSx}$ )

Although a noise-reduction and soft-start capacitor ( $C_{NR/SSx}$ ) from the NR/SSx pin to GND is not required,  $C_{NR/SSx}$  is highly recommended to control the start-up time and reduce the noise floor of the device. The typical value used is 10 nF, and the maximum recommended value is 10  $\mu$ F.

## 8.1.2 Start-Up

### 8.1.2.1 Circuit Soft-Start Control (NR/SSx)

Each output of the device features a user-adjustable, monotonic, voltage-controlled soft start that is set with an external capacitor ( $C_{NR/SSx}$ ). This soft start eliminates power-up initialization problems when powering field-programmable gate arrays (FPGAs), digital signal processors (DSPs), or other processors. The controlled voltage ramp of the output also reduces peak in-rush current during start-up, which minimizes start-up transients to the input power bus.

The output voltage ( $V_{OUTx}$ ) rises proportionally to  $V_{NR/SSx}$  during start-up as the LDO regulates so that the feedback voltage equals the NR/SSx voltage ( $V_{FBx} = V_{NR/SSx}$ ). As such, the time required for  $V_{NR/SSx}$  to reach the nominal value determines the rise time of  $V_{OUTx}$  (start-up time).

The soft-start ramp time depends on the soft-start charging current ( $I_{NR/SSx}$ ), the soft-start capacitance ( $C_{NR/SSx}$ ), and the internal reference ( $V_{REF}$ ). The approximate soft-start ramp time ( $t_{SSx}$ ) can be calculated with [Equation 4](#):

$$t_{SSx} = (V_{REF} \times C_{NR/SSx}) / I_{NR/SSx} \quad (4)$$

The SS\_CTRLx pin for each output sets the value of the internal current source, maintaining a fast start-up time even with a large  $C_{NR/SSx}$  capacitor. When the SS\_CTRLx pin is connected to GND, the typical value for the  $I_{NR/SSx}$  current is 6.2  $\mu$ A. Connecting the SS\_CTRLx pin to INx increases the typical soft-start charging current to 100  $\mu$ A. The larger charging current for  $I_{NR/SSx}$  is useful when smaller start-up ramp times are required or when using larger noise-reduction capacitors.

Not using a noise-reduction capacitor on the NR/SSx pin and tying the SS\_CTRLx pin to  $V_{INx}$  results in output voltage overshoot of approximately 10%. Connecting the SS\_CTRLx pin to GND or using a capacitor on the NR/SSx pin minimizes the overshoot.

Values for the soft-start charging currents are provided in [Electrical Characteristics](#).

#### 8.1.2.1.1 In-Rush Current

In-rush current is defined as the current into the LDO at the INx pin during start-up. In-rush current then consists primarily of the sum of load current and the current used to charge the output capacitor. This current is difficult to measure because the input capacitor must be removed, which is not recommended. However, this soft-start current can be estimated by [Equation 5](#):

$$I_{OUTx}(t) = \left[ \frac{C_{OUTx} \times dV_{OUTx}(t)}{dt} \right] + \left[ \frac{V_{OUTx}(t)}{R_{LOAD}} \right]$$

where:

- $V_{OUTx}(t)$  is the instantaneous output voltage of the turn-on ramp
- $dV_{OUTx}(t) / dt$  is the slope of the  $V_{OUTx}$  ramp
- $R_{LOAD}$  is the resistive load impedance

(5)

### 8.1.2.2 Undervoltage Lockout (UVLOx) Control

The UVLOx circuit ensures that the device stays disabled before the input or bias supplies reach the minimum operational voltage range and ensures that the device properly shuts down when the input supply collapses.

Figure 46 and Table 5 explain the UVLOx circuit response to various input voltage events, assuming  $V_{ENx} \geq V_{IH(ENx)}$ .

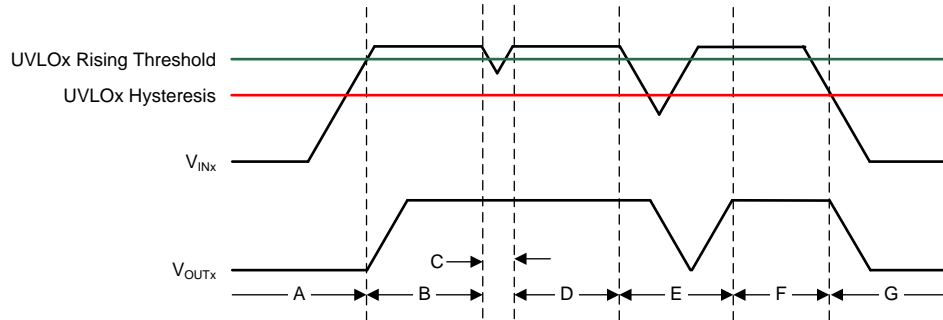

Figure 46. Typical UVLOx Operation

Table 5. Typical UVLOx Operation Description

REGION	EVENT	$V_{OUTx}$ STATUS	COMMENT
A	Turn-on, $V_{INx} \geq V_{UVLOx}$	0	Start-up
B	Regulation	1	Regulates to target $V_{OUTx}$
C	Brownout, $V_{INx} \geq V_{UVLOx} - V_{HYS}$	1	The output can fall out of regulation but the device is still enabled.
D	Regulation	1	Regulates to target $V_{OUTx}$
E	Brownout, $V_{INx} < V_{UVLOx} - V_{HYS}$	0	The device is disabled and the output falls because of the load and active discharge circuit. The device is reenabled when the UVLOx rising threshold is reached by the input voltage and a normal start-up then follows.
F	Regulation	1	Regulates to target $V_{OUTx}$
G	Turn-off, $V_{INx} < V_{UVLOx} - V_{HYS}$	0	The output falls because of the load and active discharge circuit.

Similar to many other LDOs with this feature, the UVLOx circuit takes a few microseconds to fully assert. During this time, a downward line transient below approximately 0.8 V causes the UVLOx to assert for a short time; however, the UVLOx circuit does not have enough stored energy to fully discharge the internal circuits inside of the device. When the UVLOx circuit is not given enough time to fully discharge the internal nodes, the outputs are not fully disabled.

The effect of the downward line transient can be mitigated by using a larger input capacitor to increase the fall time of the input supply when operating near the minimum  $V_{INx}$ .

### 8.1.2.3 Power-Good (PGx) Function

The power-good circuit monitors the voltage at the feedback pin to indicate the status of the output voltage. The power-good circuit asserts whenever FBx, VINx, or ENx are below the thresholds. The PGx operation versus the output voltage is shown in Figure 47, which Table 6 describes.

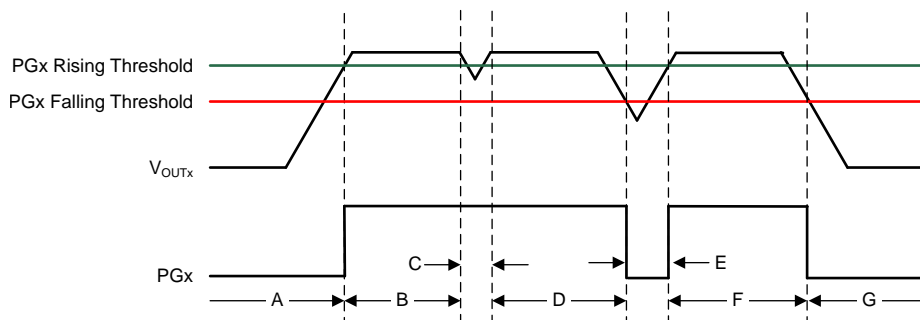

Figure 47. Typical PGx Operation

Table 6. Typical PGx Operation Description

REGION	EVENT	PGx STATUS	FBx VOLTAGE
A	Turn-on	0	$V_{FBx} < V_{IT(PGx)} + V_{HYS(PGx)}$
B	Regulation	Hi-Z	$V_{FBx} \geq V_{IT(PGx)}$
C	Output voltage dip	Hi-Z	
D	Regulation	Hi-Z	
E	Output voltage dip	0	$V_{FBx} < V_{IT(PGx)}$
F	Regulation	Hi-Z	$V_{FBx} \geq V_{IT(PGx)}$
G	Turn-off	0	$V_{FBx} < V_{IT(PGx)}$

The PGx pin is open-drain and connecting a pullup resistor to an external supply enables other devices to receive power-good as a logic signal that can be used for sequencing. Make sure that the external pullup supply voltage results in a valid logic signal for the receiving device or devices.

To ensure proper operation of the power-good circuit, the pullup resistor value must be between 10 kΩ and 100 kΩ. The lower limit of 10 kΩ results from the maximum pulldown strength of the power-good transistor, and the upper limit of 100 kΩ results from the maximum leakage current at the power-good node. If the pullup resistor is outside of this range, then the power-good signal may not read a valid digital logic level.

Using a large  $C_{FFx}$  with a small  $C_{NR/SSx}$  causes the power-good signal to incorrectly indicate that the output voltage has settled during turn-on. The  $C_{FFx}$  time constant must be greater than the soft-start time constant to ensure proper operation of the PGx during start-up. For a detailed description, see [Pros and Cons of Using a Feedforward Capacitor with a Low Dropout Regulator](#).

The state of PGx is only valid when the device operates above the minimum supply voltage. During short brownout events and at light loads, power-good does not assert because the output voltage (therefore  $V_{FBx}$ ) is sustained by the output capacitance.

### 8.1.3 AC and Transient Performance

LDO AC performance for a dual-channel device includes power-supply rejection ratio, channel-to-channel output isolation, output current transient response, and output noise. These metrics are primarily a function of open-loop gain, bandwidth, and phase margin that control the closed-loop input and output impedance of the LDO. The output noise is primarily a result of the reference and error amplifier noise.

### 8.1.3.1 Power-Supply Rejection Ratio (PSRR)

PSRR is a measure of how well the LDO control-loop rejects signals from  $V_{INx}$  to  $V_{OUTx}$  across the frequency spectrum (usually 10 Hz to 10 MHz). Equation 6 shows the PSRR calculation as a function of frequency for the input signal ( $V_{INx}(f)$ ) and output signal ( $V_{OUTx}(f)$ ).

$$PSRR \text{ (dB)} = 20 \text{ Log}_{10} \left( \frac{V_{INx}(f)}{V_{OUTx}(f)} \right) \tag{6}$$

Even though PSRR is a loss in signal amplitude, PSRR is shown as positive values in decibels (dB) for convenience.

A simplified diagram of PSRR versus frequency is shown in Figure 48.

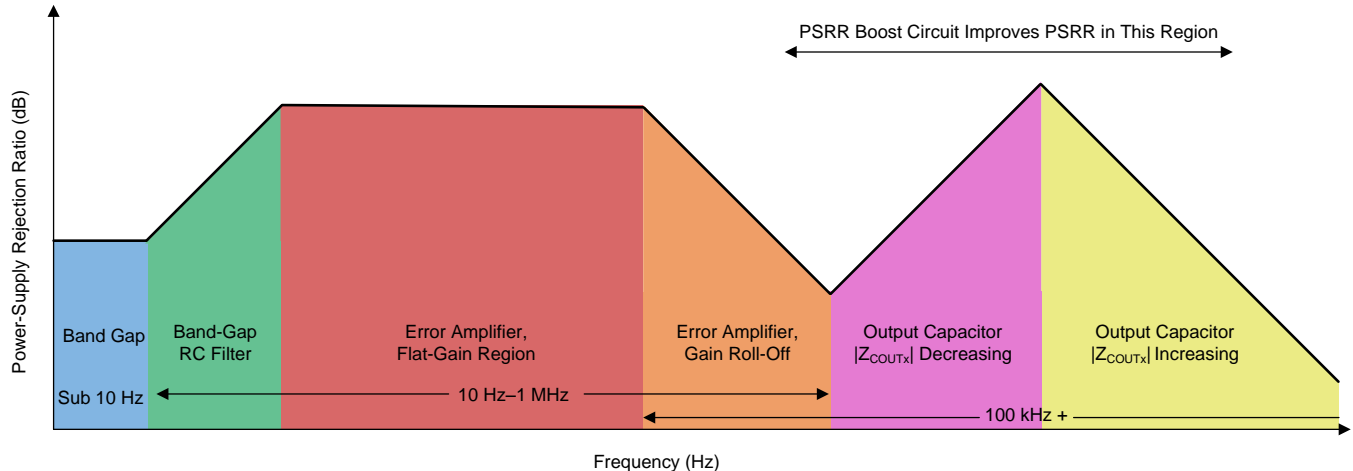

Figure 48. Power-Supply Rejection Ratio Diagram

An LDO is often employed not only as a DC-DC regulator, but also to provide exceptionally clean power-supply voltages that exhibit ultra-low noise and ripple to sensitive system components. This usage is especially true for the TPS7A88-Q1.

The TPS7A88-Q1 features an innovative circuit to boost the PSRR between 200 kHz and 1 MHz; see Figure 4. To achieve the maximum benefit of this PSRR boost circuit, using a capacitor with a minimum impedance in the 100-kHz to 1-MHz band is recommended.

### 8.1.3.2 Channel-to-Channel Output Isolation and Crosstalk

Output isolation is a measure of how well the device prevents voltage disturbances on one output from affecting the other output. This attenuation appears in load transient tests on the other output; however, to numerically quantify the rejection, the output channel isolation is expressed in decibels (dB).

Output isolation performance is a strong function of the PCB layout. See Layout on how to optimize the isolation performance.



### 8.1.3.3 Output Voltage Noise

The TPS7A88-Q1 is designed for system applications where minimizing noise on the power-supply rail is critical to system performance. For example, the TPS7A88-Q1 can be used in a phase-locked loop (PLL)-based clocking circuit can be used for minimum phase noise, or in test and measurement systems where small power-supply noise fluctuations reduce system dynamic range.

LDO noise is defined as the internally-generated intrinsic noise created by the semiconductor circuits alone. This noise is the sum of various types of noise (such as shot noise associated with current-through-pin junctions, thermal noise caused by thermal agitation of charge carriers, flicker noise, or 1/f noise and dominates at lower frequencies as a function of 1/f). Figure 49 shows a simplified output voltage noise density plot versus frequency.

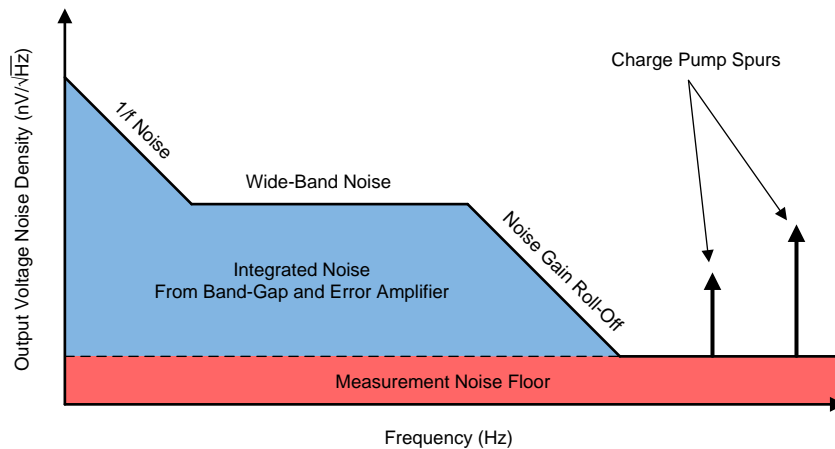

Figure 49. Output Voltage Noise Diagram

For further details, see [How to Measure LDO Noise](#).

### 8.1.3.4 Optimizing Noise and PSRR

The ultra-low noise floor and PSRR of the device can be improved in several ways, as Table 7 describes.

Table 7. Effect of Various Parameters on AC Performance<sup>(1)(2)</sup>

PARAMETER	NOISE			PSRR		
	LOW-FREQUENCY	MID-FREQUENCY	HIGH-FREQUENCY	LOW-FREQUENCY	MID-FREQUENCY	HIGH-FREQUENCY
C <sub>NR/SSx</sub>	+++	No effect	No effect	+++	+	No effect
C <sub>FFx</sub>	++	+++	+	++	+++	+
C <sub>OUTx</sub>	No effect	+	+++	No effect	+	+++
V <sub>INx</sub> – V <sub>OUTx</sub>	+	+	+	+++	+++	++
PCB layout	++	++	+	+	+++	+++

(1) The number of plus signs indicate the improvement in noise or PSRR performance by increasing the parameter value.

(2) Shaded cells indicate the easiest improvement to noise or PSRR performance.

The noise-reduction capacitor (in conjunction with the noise-reduction resistor) forms a low-pass filter (LPF) that filters out the noise from the reference before gaining up with the error amplifier, which minimizes the output voltage noise floor. The LPF is a single-pole filter and the cutoff frequency can be calculated with Equation 7. The typical value of R<sub>NR</sub> is 250 kΩ. The effect of the C<sub>NR/SSx</sub> capacitor increases when V<sub>OUTx(Target)</sub> increases because the noise from the reference is gained up when the output voltage increases. For low-noise applications, a 10-nF to 10-μF C<sub>NR/SSx</sub> is recommended.

$$f_{\text{cutoff}} = 1 / (2 \times \pi \times R_{\text{NR}} \times C_{\text{NR/SSx}}) \quad (7)$$

The feedforward capacitor reduces output voltage noise by filtering out the mid-band frequency noise. The feedforward capacitor can be optimized by placing a pole-zero pair near the edge of the loop bandwidth and pushing out the loop bandwidth, thus improving mid-band PSRR.

A larger  $C_{OUTx}$  or multiple output capacitors reduces high-frequency output voltage noise and PSRR by reducing the high-frequency output impedance of the power supply.

Additionally, a higher input voltage improves the noise and PSRR because greater headroom is provided for the internal circuits. However, a high power dissipation across the die increases the output noise because of the increase in junction temperature.

Good PCB layout improves the PSRR and noise performance by providing heat sinking at low frequencies and isolating  $V_{OUTx}$  at high frequencies.

#### 8.1.3.4.1 Charge Pump Noise

The device internal charge pump generates a minimal amount of noise.

The high-frequency components of the output voltage noise density curve are filtered out in most applications by using 10-nF to 100-nF bypass capacitors close to the load. Using a ferrite bead between the LDO output and the load input capacitors forms a pi-filter with reduces the high-frequency noise contribution.

#### 8.1.3.5 Load Transient Response

The load-step transient response is the output voltage response by the LDO to a step in load current, whereby output voltage regulation is maintained. There are two key transitions during a load transient response: the transition from a light to a heavy load and the transition from a heavy to a light load. The regions shown in [Figure 50](#) are broken down in this section and are described in [Table 8](#). Regions A, E, and H are where the output voltage is in steady-state.

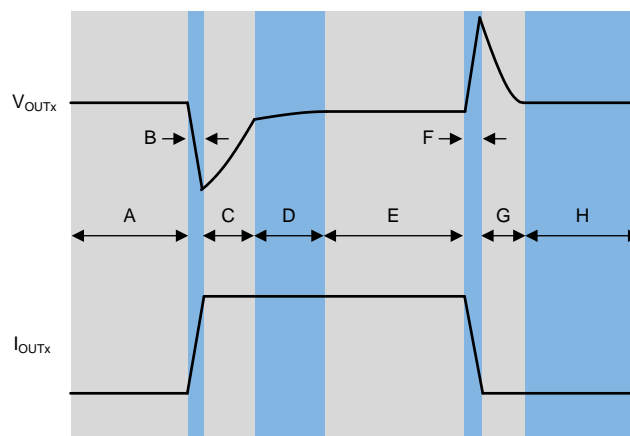

**Figure 50. Load Transient Waveform**

**Table 8. Load Transient Waveform Description**

REGION	DESCRIPTION	COMMENT
A	Regulation	Regulation
B	Output current ramping	Initial voltage dip is a result of the depletion of the output capacitor charge.
C	LDO responding to transient	Recovery from the dip results from the LDO increasing the sourcing current, and leads to output voltage regulation.
D	Reaching thermal equilibrium	At high load currents the LDO takes some time to heat up. During this time the output voltage changes slightly.
E	Regulation	Regulation
F	Output current ramping	Initial voltage rise results from the LDO sourcing a large current, and leads to the output capacitor charge to increase.
G	LDO responding to transient	Recovery from the rise results from the LDO decreasing the sourcing current in combination with the load discharging the output capacitor.
H	Regulation	Regulation

The transient response peaks ( $V_{OUTx(max)}$  and  $V_{OUTx(min)}$ ) are improved by using more output capacitance; however, doing so slows down the recovery time ( $W_{rise}$  and  $W_{fall}$ ). Figure 51 shows these parameters during a load transient with a given pulse duration (PW) and current levels ( $I_{OUTx(LO)}$  and  $I_{OUTx(HI)}$ ).

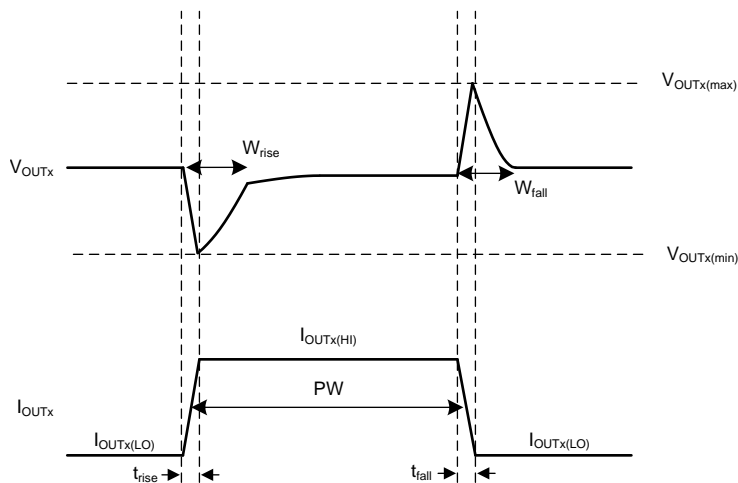

Figure 51. Simplified Load Transient Waveform

## 8.1.4 DC Performance

### 8.1.4.1 Output Voltage Accuracy ( $V_{OUTx}$ )

The device features an output voltage accuracy of 1% maximum that includes the errors introduced by the internal reference, load regulation, line regulation, and operating temperature as specified by [Electrical Characteristics](#). Output voltage accuracy specifies minimum and maximum output voltage error relative to the expected nominal output voltage stated as a percent.

### 8.1.4.2 Dropout Voltage ( $V_{DO}$ )

Generally speaking, the dropout voltage often refers to the minimum voltage difference between the input and output voltage ( $V_{DO} = V_{INx} - V_{OUTx}$ ) that is required for regulation. When  $V_{INx}$  drops below the required  $V_{DO}$  for the given load current, the device functions as a resistive switch and does not regulate output voltage. Dropout voltage is proportional to the output current because the device is operating as a resistive switch, as shown in [Figure 52](#).

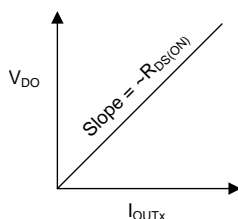

Figure 52. Dropout Voltage versus Output Current

Dropout voltage is affected by the drive strength for the gate of the pass element, which is nonlinear with respect to  $V_{INx}$  on this device because of the internal charge pump. Dropout voltage increases exponentially when the input voltage nears the maximum operating voltage because the charge pump multiplies the input voltage by a factor of 4 and then is internally clamped.

#### 8.1.4.2.1 Behavior When Transitioning From Dropout Into Regulation

Some applications can have transients that place the LDO into dropout, such as slower ramps on  $V_{INx}$  for start-up or load transients. As with other LDOs, the output can overshoot on recovery from these conditions.

A ramping input supply can cause an LDO to overshoot on start-up when the slew rate and voltage levels are in the right range, as shown in [Figure 53](#). This condition is easily avoided by using an enable signal or increasing the soft-start time with  $C_{SS}/NR_X$ .

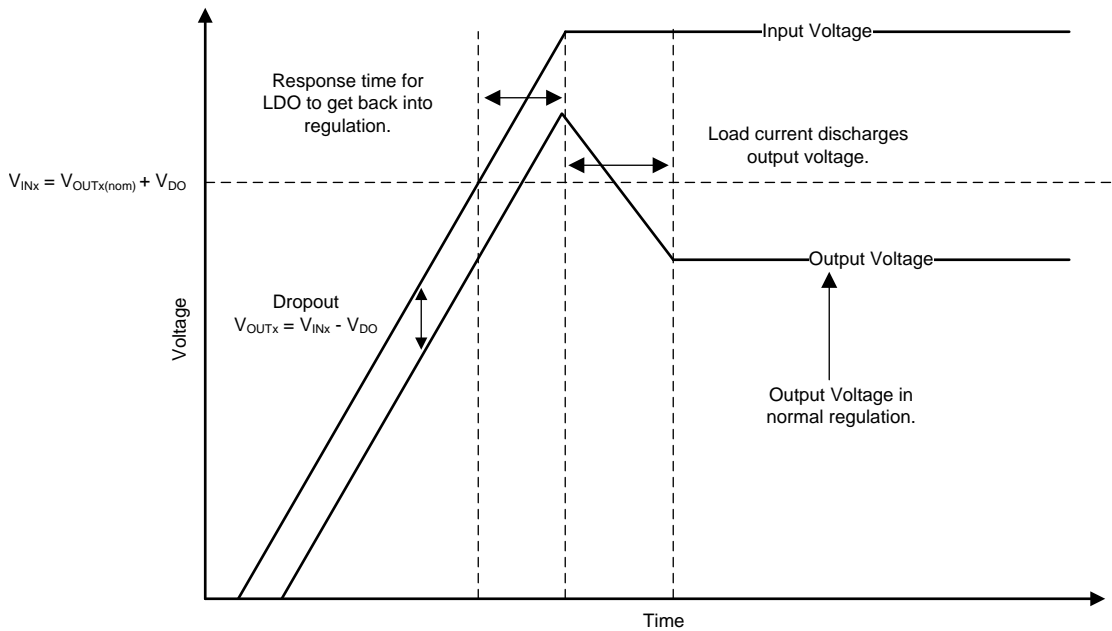

Figure 53. Start-Up Into Dropout

### 8.1.5 Reverse Current Protection

As with most LDOs, this device can be damaged by excessive reverse current.

Reverse current is current that flows through the body diode on the pass element instead of the normal conducting channel. At high enough magnitudes, this current flow degrades long-term reliability of the device resulting from risks of electromigration and excess heat that is dissipated across the device. If the current flow is high enough, a latch-up condition can be entered.

Conditions where excessive reverse current can occur are outlined in this section, all of which can exceed the absolute maximum rating of  $V_{OUTX} > V_{INX} + 0.3\text{ V}$ :

- If the device has a large  $C_{OUTX}$  and the input supply collapses quickly with little or no load current
- The output is biased when the input supply is not established
- The output is biased above the input supply

If excessive reverse current flow is expected in the application, then external protection must be used to protect the device. [Figure 54](#) shows one approach of protecting the device.

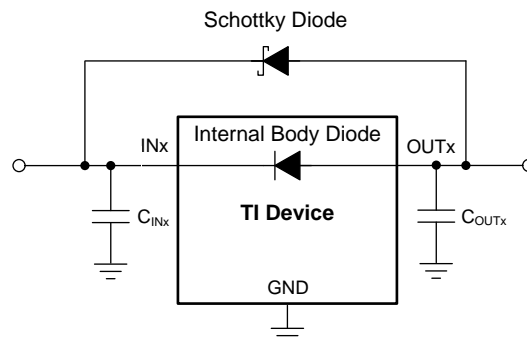

Copyright © 2016, Texas Instruments Incorporated

Figure 54. Example Circuit for Reverse Current Protection Using a Schottky Diode

### 8.1.6 Power Dissipation ( $P_D$ )

Circuit reliability demands that proper consideration is given to device power dissipation, location of the circuit on the printed circuit board (PCB), and correct sizing of the thermal plane. The PCB area around the regulator must be as free as possible of other heat-generating devices that cause added thermal stresses.

As a first-order approximation, power dissipation in the regulator depends on the input-to-output voltage difference and load conditions.  $P_D$  can be approximated using [Equation 8](#):

$$P_D = (V_{OUTx} - V_{INx}) \times I_{OUTx} \quad (8)$$

An important note is that power dissipation can be minimized, and thus greater efficiency achieved, by proper selection of the system voltage rails. Proper selection allows the minimum input-to-output voltage differential to be obtained. The low dropout of the device allows for maximum efficiency across a wide range of output voltages.

The main heat conduction path for the device is through the thermal pad on the package. As such, the thermal pad must be soldered to a copper pad area under the device. This pad area contains an array of plated vias that conduct heat to any inner plane areas or to a bottom-side copper plane.

The maximum power dissipation determines the maximum allowable junction temperature ( $T_J$ ) for the device. Power dissipation and junction temperature are most often related by the junction-to-ambient thermal resistance ( $\theta_{JA}$ ) of the combined PCB, device package, and the temperature of the ambient air ( $T_A$ ), according to [Equation 9](#). The equation is rearranged for output current in [Equation 10](#).

$$T_J = T_A + \theta_{JA} \times P_D \quad (9)$$

$$I_{OUTx} = (T_J - T_A) / [\theta_{JA} \times (V_{INx} - V_{OUTx})] \quad (10)$$

Unfortunately, this thermal resistance ( $\theta_{JA}$ ) is highly dependent on the heat-spreading capability built into the particular PCB design, and therefore varies according to the total copper area, copper weight, and location of the planes. The  $\theta_{JA}$  recorded in the table is determined by the JEDEC standard, PCB, and copper-spreading area, and is only used as a relative measure of package thermal performance. Note that for a well-designed thermal layout,  $\theta_{JA}$  is actually the sum of the VQFN package junction-to-case (bottom) thermal resistance ( $\theta_{JCbot}$ ) plus the thermal resistance contribution by the PCB copper.

#### 8.1.6.1 Estimating Junction Temperature

The JEDEC standard now recommends the use of psi ( $\Psi$ ) thermal metrics to estimate the junction temperatures of the LDO when in-circuit on a typical PCB board application. These metrics are not strictly speaking thermal resistances, but rather offer practical and relative means of estimating junction temperatures. These psi metrics are determined to be significantly independent of the copper-spreading area. The key thermal metrics ( $\Psi_{JT}$  and  $\Psi_{JB}$ ) are given in the table and are used in accordance with [Equation 11](#).

$$\Psi_{JT}: T_J = T_T + \Psi_{JT} \times P_D$$

$$\Psi_{JB}: T_J = T_B + \Psi_{JB} \times P_D$$

where:

- $P_D$  is the power dissipated as explained in [Equation 8](#)
- $T_T$  is the temperature at the center-top of the device package, and
- $T_B$  is the PCB surface temperature measured 1 mm from the device package and centered on the package edge

(11)

## 8.2 Typical Application

This section discusses the implementation of the TPS7A88-Q1 to regulate from a common input voltage to two output voltages of the same value. This is a common application where two noise-sensitive loads must have the same supply voltage but have high channel-to-channel isolation. The schematic for this application circuit is shown in [Figure 55](#).

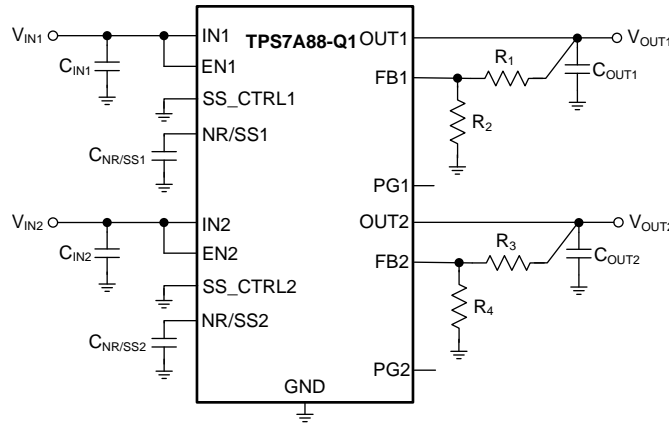

Copyright © 2017, Texas Instruments Incorporated

**Figure 55. Application Example**

### 8.2.1 Design Requirements

For the design example shown in [Figure 55](#), use the parameters listed in [Table 9](#) as the input parameters.

**Table 9. Design Parameters**

PARAMETER	DESIGN REQUIREMENT
Input voltages ( $V_{IN1}$ and $V_{IN2}$ )	1.8 V, $\pm 3\%$ , provided by the DC-DC converter switching at 750 kHz
Maximum ambient operating temperature	55°C
Output voltages ( $V_{OUT1}$ and $V_{OUT2}$ )	1.2 V, $\pm 1\%$ , output voltages are isolated
Output currents ( $I_{OUT1}$ and $I_{OUT2}$ )	1 A (maximum), 10 mA (minimum)
Channel-to-channel isolation	Isolation greater than 50 dB at 100 kHz
RMS noise	$< 5 \mu V_{RMS}$ , bandwidth = 10 Hz to 100 kHz
PSRR at 750 kHz	$> 40$ dB
Start-up time	$< 5$ ms

### 8.2.2 Detailed Design Procedure

The output voltages can be set to 1.2 V by selecting the correct values for  $R_1$ ,  $R_3$  and  $R_2$ ,  $R_4$ ; see [Equation 1](#).

Input and output capacitors are selected in accordance with [External Component Selection](#). Ceramic capacitances of 10  $\mu F$  for inputs and outputs are selected.

To satisfy the required startup time ( $t_{SSx}$ ) and still maintain low-noise performance, a 0.1- $\mu F$   $C_{NR/SSx}$  is selected for channels with  $SS\_CTRL1$  and  $SS\_CTRL2$  connected to  $V_{IN1}$  and  $V_{IN2}$ , respectively. This value is calculated with [Equation 12](#).

$$t_{SSx} = (V_{REF} \times C_{NR/SSx}) / I_{NR/SSx} \quad (12)$$

With a 1-A maximum load, the internal power dissipation is 600 mW per channel (or 1.2-W total), which corresponds to a 40°C junction temperature increase. With an 55°C maximum ambient temperature, the junction temperature is at 95°C. To minimize noise, a feedforward capacitance ( $C_{FF}$ ) of 10 nF is selected.

Channel-to-channel isolation depends significantly on the layout of the design. To minimize crosstalk between the outputs, keep the output capacitor grounds on separate sides of the design. See [Layout](#) for an example of how to layout the TPS7A88-Q1 to achieve best PSRR, channel-to-channel isolation, and noise.

### 8.2.3 Application Curves

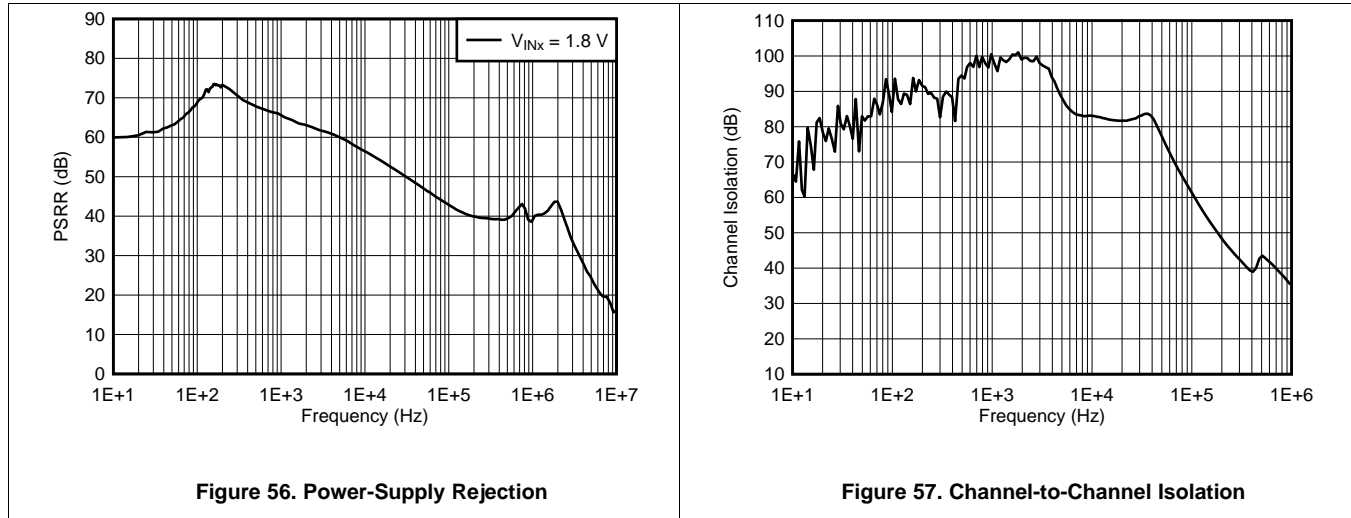

Figure 56. Power-Supply Rejection

Figure 57. Channel-to-Channel Isolation

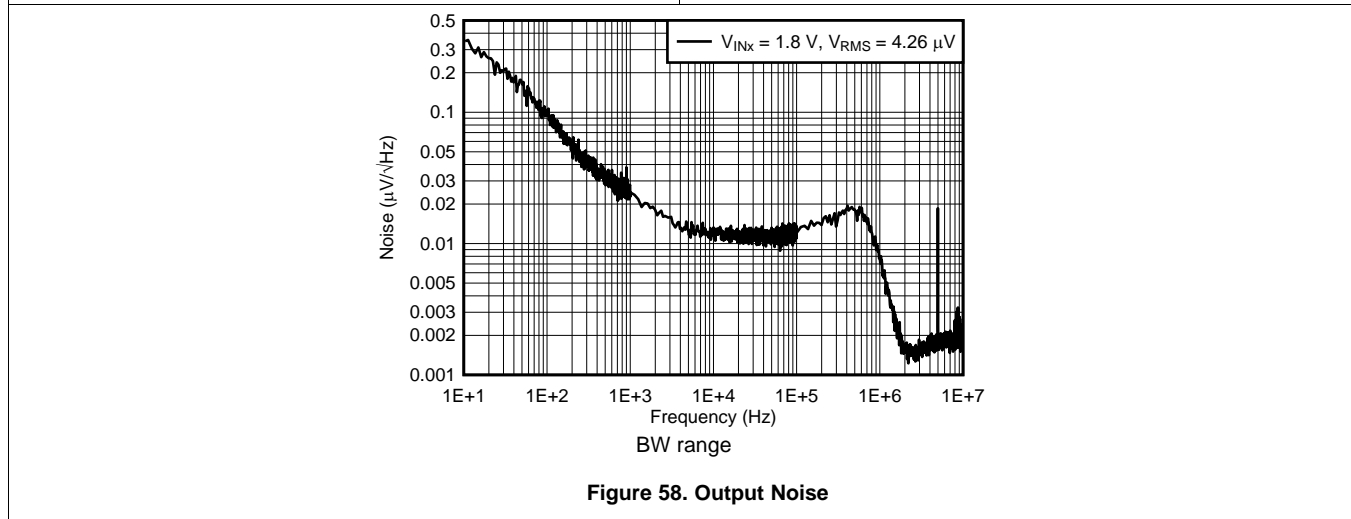

Figure 58. Output Noise

## 9 Power Supply Recommendations

Both inputs of the TPS7A88-Q1 are designed to operate from an input voltage range between 1.4 V and 6.5 V. The input voltage range must provide adequate headroom for the device to have a regulated output. This input supply must be well-regulated. If the input supply is noisy, additional input capacitors with low ESR can help improve the output noise performance.

## 10 Layout

### 10.1 Layout Guidelines

General guidelines for linear regulator designs are to place all circuit components on the same side of the circuit board and as near as practical to the respective LDO pin connections. Place ground return connections to the input and output capacitor, and to the LDO ground pin as close to each other as possible, connected by a wide, component-side, copper surface. The use of vias and long traces to create LDO circuit connections is strongly discouraged and negatively affects system performance.

#### 10.1.1 Board Layout

To maximize the AC performance of the TPS7A88-Q1, TI recommends following the layout example shown in [Figure 59](#). This layout isolates the analog ground (AGND) from the noisy power ground. Components that must be connected to the quiet analog ground are the noise reduction capacitors ( $C_{NR/SSx}$ ) and the lower feedback resistors ( $R_2$  and  $R_4$ ). These components must have a separate connection back to the power pad of the device. To minimize crosstalk between the two outputs, the output capacitor grounds are positioned on opposite sides of the layout and only connect back to the device at opposite sides of the thermal pad. TI recommends connecting the GND pins directly to the thermal pad and not to any external plane.

To maximize the output voltage accuracy, the connection from each output voltage back to top output divider resistors ( $R_1$  and  $R_3$ ) must be made as close as possible to the load. This method of connecting the feedback trace eliminates the voltage drop from the device output to the load.

To improve thermal performance, a thermal via array must connect the thermal pad to internal ground planes. A larger area for the internal ground planes improves the thermal performance and lowers the operating temperature of the device.



## 10.2 Layout Example

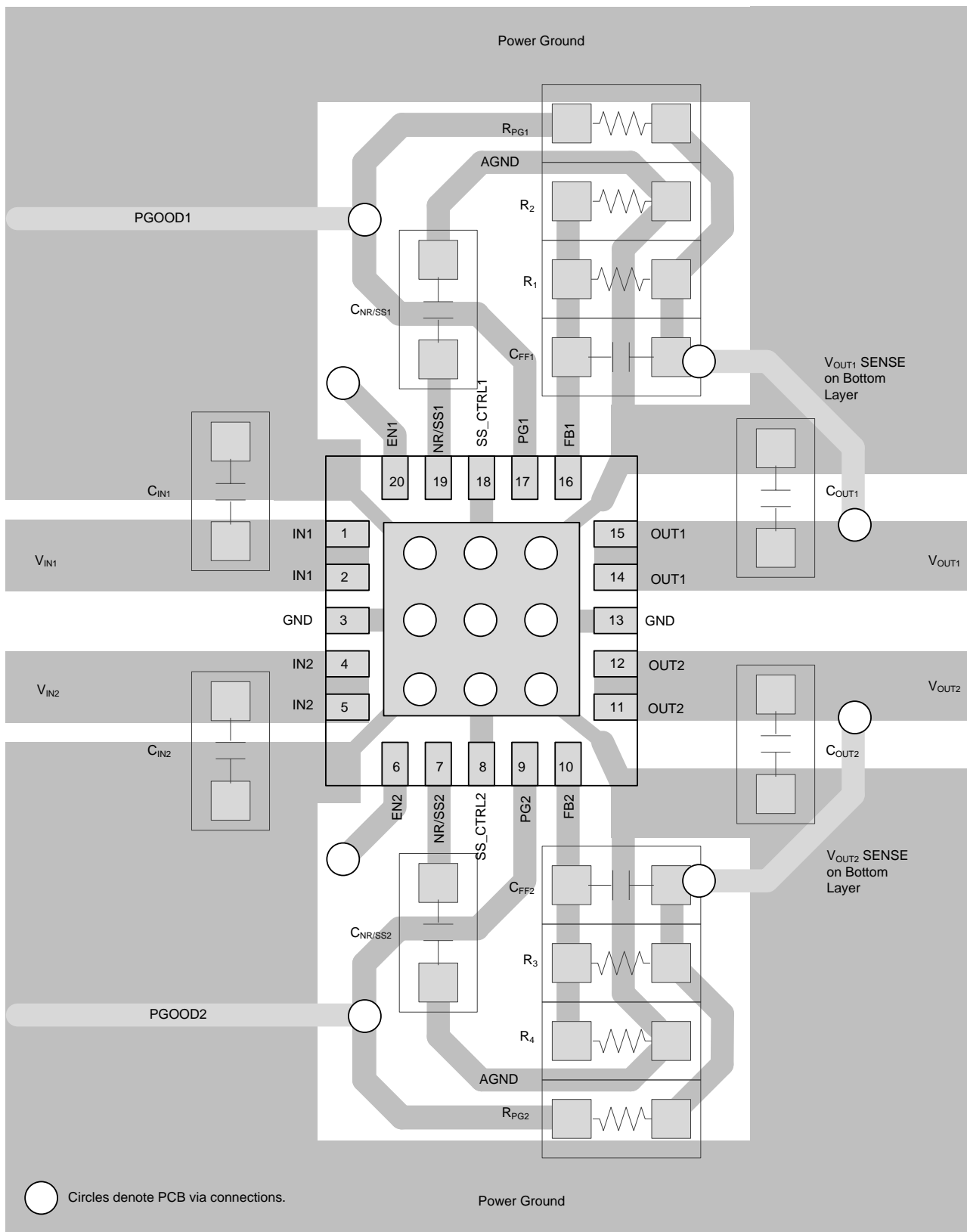

Figure 59. TPS7A88-Q1 Example Layout

## 11 Device and Documentation Support

### 11.1 Device Support

#### 11.1.1 Development Support

##### 11.1.1.1 Evaluation Modules

An evaluation module (EVM) is available to assist in the initial circuit performance evaluation using the TPS7A88-Q1. The summary information for this fixture is listed in [Table 10](#).

**Table 10. Design Kits & Evaluation Modules<sup>(1)</sup>**

NAME	PART NUMBER
<a href="#">TPS7A88- Low-Dropout Voltage Regulator Evaluation Module</a>	TPS7A88EVM-776

(1) For the most current package and ordering information see the Package Option Addendum at the end of this document, or see the device product folder at [www.ti.com](http://www.ti.com).

The EVM can be requested at the Texas Instruments website ([www.ti.com](http://www.ti.com)) through the TPS7A88-Q1 product folder.

##### 11.1.1.2 Spice Models

Computer simulation of circuit performance using spice is often useful when analyzing the performance of analog circuits and systems. A spice model for the TPS7A88-Q1 is available through the TPS7A88-Q1 product folder under simulation models.

#### 11.1.2 Device Nomenclature

**Table 11. Ordering Information<sup>(1)</sup>**

PRODUCT	DESCRIPTION
TPS7A88xxQYYYYZ -Q1	YYY is the package designator. XX represents the output voltage. 01 is the adjustable output version. Z is the package quantity.

(1) For the most current package and ordering information see the Package Option Addendum at the end of this document, or see the device product folder at [www.ti.com](http://www.ti.com).

### 11.2 Documentation Support

#### 11.2.1 Related Documentation

[TPS3780 Data Sheet](#) (SBVS250)

[TPS7A88 Evaluation Module](#) (SBVU027)

[Pros and Cons of Using a Feed-Forward Capacitor with a Low Dropout Regulator](#) (SBVA042)

[How to Measure LDO Noise](#) (SLYY076)

#### 11.3 Community Resources

The following links connect to TI community resources. Linked contents are provided "AS IS" by the respective contributors. They do not constitute TI specifications and do not necessarily reflect TI's views; see TI's [Terms of Use](#).

**TI E2E™ Online Community** *TI's Engineer-to-Engineer (E2E) Community*. Created to foster collaboration among engineers. At [e2e.ti.com](http://e2e.ti.com), you can ask questions, share knowledge, explore ideas and help solve problems with fellow engineers.

**Design Support** *TI's Design Support* Quickly find helpful E2E forums along with design support tools and contact information for technical support.

## 11.4 Trademarks

E2E is a trademark of Texas Instruments.  
All other trademarks are the property of their respective owners.

## 11.5 Electrostatic Discharge Caution



This integrated circuit can be damaged by ESD. Texas Instruments recommends that all integrated circuits be handled with appropriate precautions. Failure to observe proper handling and installation procedures can cause damage.

ESD damage can range from subtle performance degradation to complete device failure. Precision integrated circuits may be more susceptible to damage because very small parametric changes could cause the device not to meet its published specifications.

## 11.6 Glossary

[SLYZ022](#) — *TI Glossary*.

This glossary lists and explains terms, acronyms, and definitions.

## 12 Mechanical, Packaging, and Orderable Information

The following pages include mechanical, packaging, and orderable information. This information is the most current data available for the designated devices. This data is subject to change without notice and revision of this document. For browser-based versions of this data sheet, refer to the left-hand navigation.



RTJ0020J

PACKAGE OUTLINE

WQFN - 0.8 mm max height

PLASTIC QUAD FLATPACK - NO LEAD

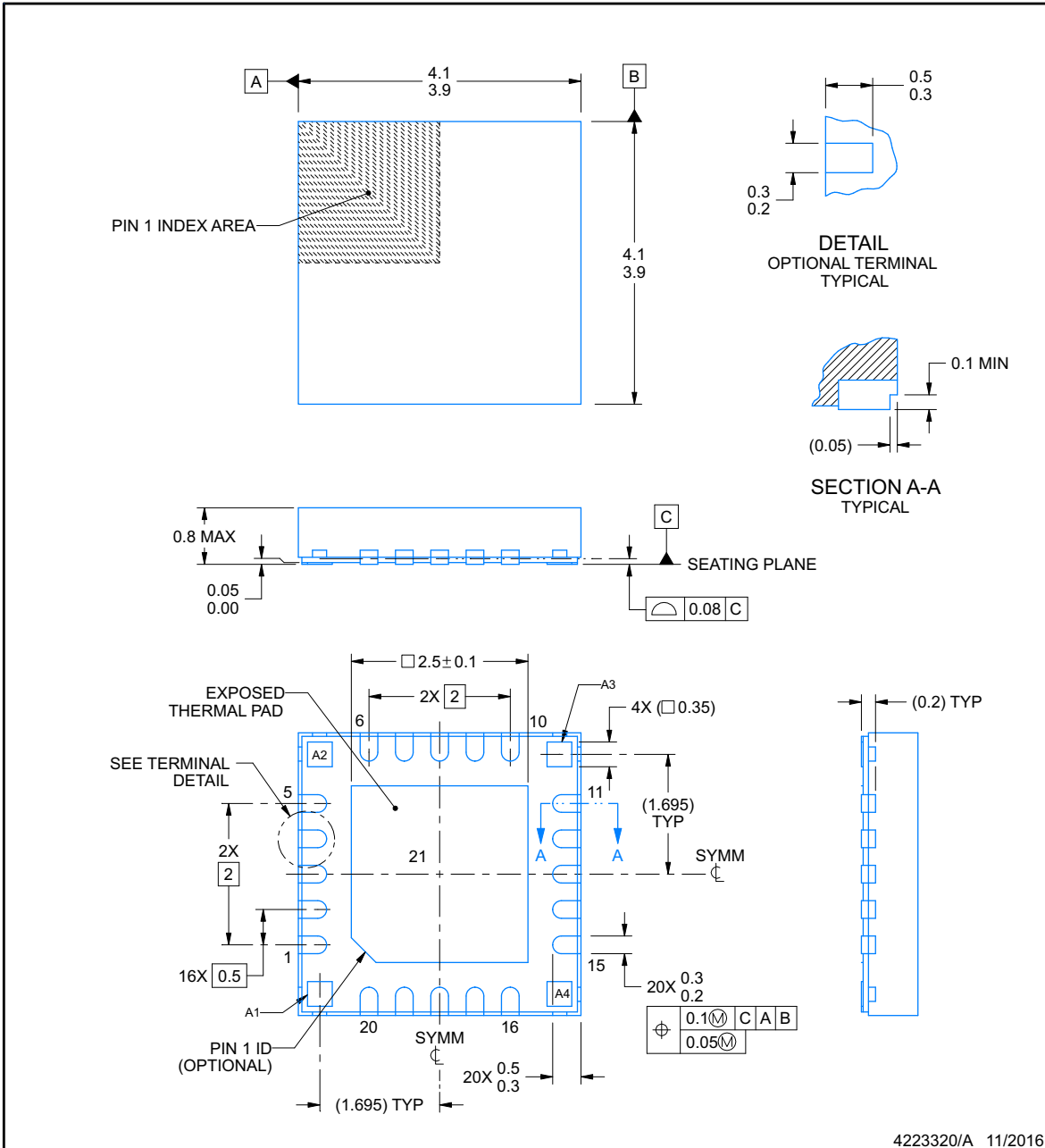

4223320/A 11/2016

NOTES:

1. All linear dimensions are in millimeters. Any dimensions in parenthesis are for reference only. Dimensioning and tolerancing per ASME Y14.5M.
2. This drawing is subject to change without notice.
3. The package thermal pad must be soldered to the printed circuit board for thermal and mechanical performance.

## EXAMPLE BOARD LAYOUT

RTJ0020J

WQFN - 0.8 mm max height

PLASTIC QUAD FLATPACK - NO LEAD

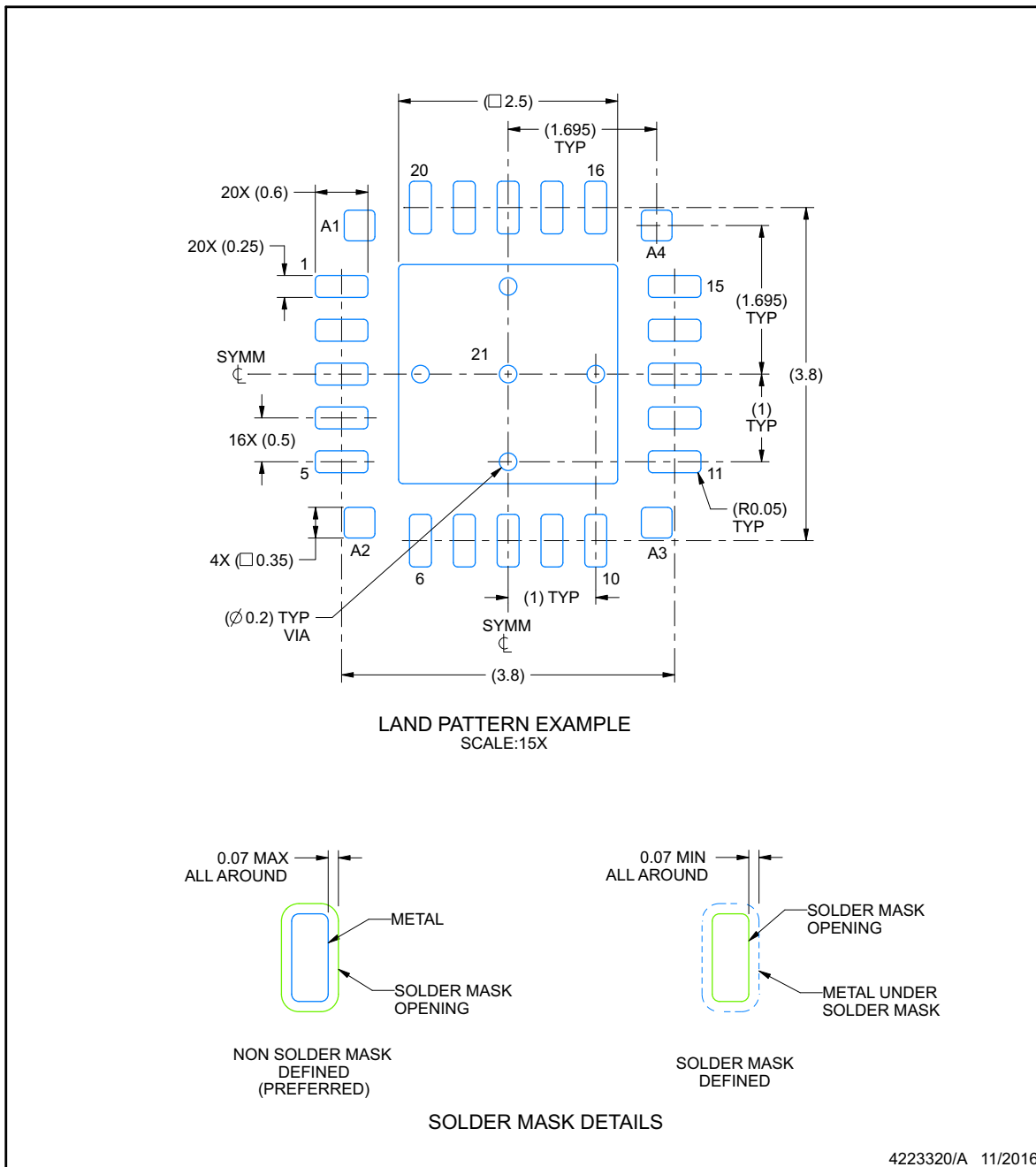

NOTES: (continued)

- This package is designed to be soldered to a thermal pad on the board. For more information, see Texas Instruments literature number SLUA271 ([www.ti.com/lit/sluea271](http://www.ti.com/lit/sluea271)).
- Vias are optional depending on application, refer to device data sheet. If any vias are implemented, refer to their locations shown on this view. It is recommended that vias under paste be filled, plugged or tented.

**EXAMPLE STENCIL DESIGN**

**RTJ0020J**

**WQFN - 0.8 mm max height**

PLASTIC QUAD FLATPACK - NO LEAD

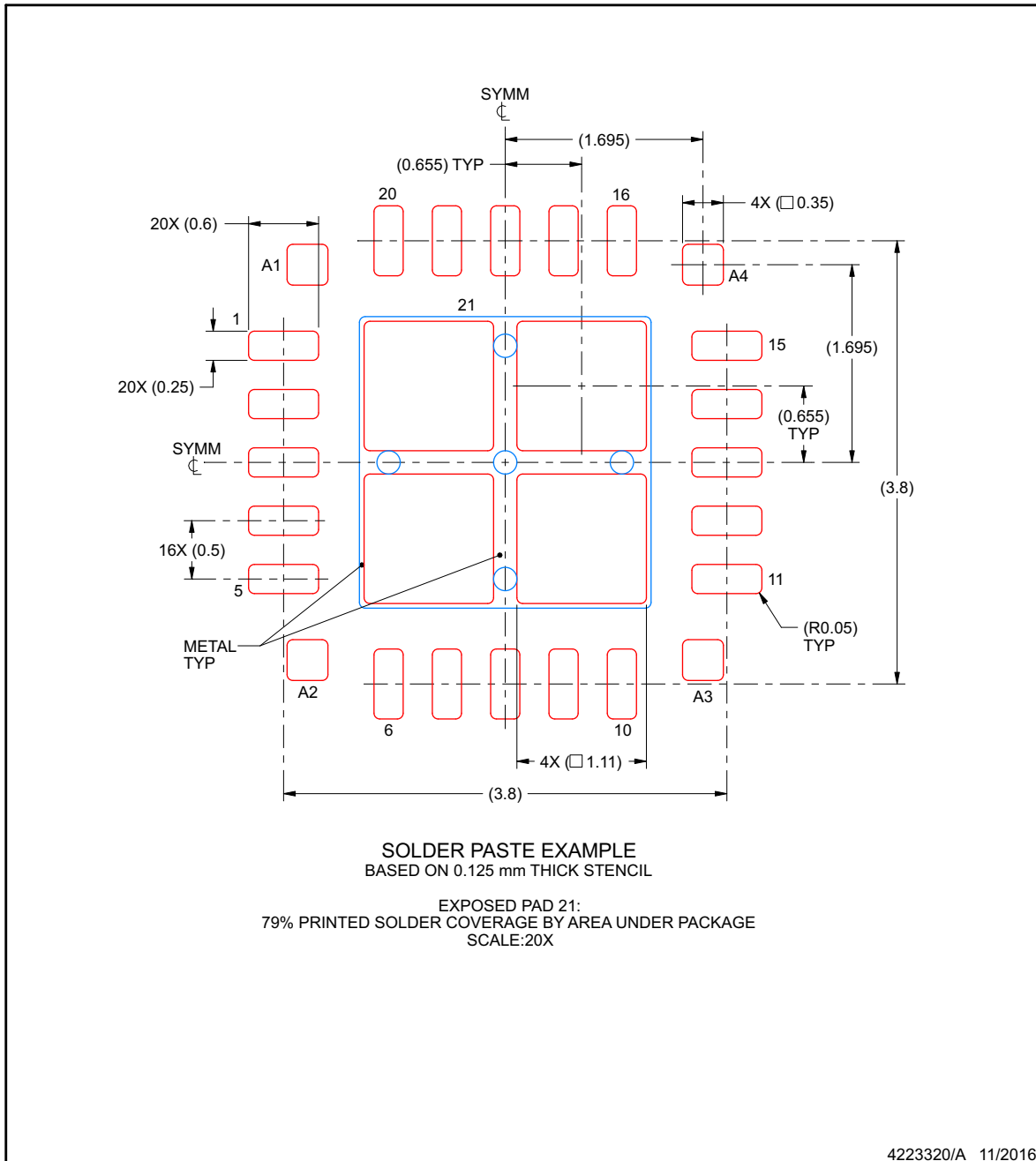

NOTES: (continued)

6. Laser cutting apertures with trapezoidal walls and rounded corners may offer better paste release. IPC-7525 may have alternate design recommendations.

**PACKAGING INFORMATION**

Orderable part number	Status (1)	Material type (2)	Package   Pins	Package qty   Carrier	RoHS (3)	Lead finish/ Ball material (4)	MSL rating/ Peak reflow (5)	Op temp (°C)	Part marking (6)
<a href="#">TPS7A8801QRTJRQ1</a>	Active	Production	QFN (RTJ)   20	3000   LARGE T&R	Yes	SN	Level-2-260C-1 YEAR	-40 to 140	-----> 7A88Q
TPS7A8801QRTJRQ1.A	Active	Production	QFN (RTJ)   20	3000   LARGE T&R	Yes	SN	Level-2-260C-1 YEAR	-40 to 140	-----> 7A88Q
TPS7A8801QRTJRQ1.B	Active	Production	QFN (RTJ)   20	3000   LARGE T&R	Yes	SN	Level-2-260C-1 YEAR	-40 to 140	-----> 7A88Q

(1) **Status:** For more details on status, see our [product life cycle](#).

(2) **Material type:** When designated, preproduction parts are prototypes/experimental devices, and are not yet approved or released for full production. Testing and final process, including without limitation quality assurance, reliability performance testing, and/or process qualification, may not yet be complete, and this item is subject to further changes or possible discontinuation. If available for ordering, purchases will be subject to an additional waiver at checkout, and are intended for early internal evaluation purposes only. These items are sold without warranties of any kind.

(3) **RoHS values:** Yes, No, RoHS Exempt. See the [TI RoHS Statement](#) for additional information and value definition.

(4) **Lead finish/Ball material:** Parts may have multiple material finish options. Finish options are separated by a vertical ruled line. Lead finish/Ball material values may wrap to two lines if the finish value exceeds the maximum column width.

(5) **MSL rating/Peak reflow:** The moisture sensitivity level ratings and peak solder (reflow) temperatures. In the event that a part has multiple moisture sensitivity ratings, only the lowest level per JEDEC standards is shown. Refer to the shipping label for the actual reflow temperature that will be used to mount the part to the printed circuit board.

(6) **Part marking:** There may be an additional marking, which relates to the logo, the lot trace code information, or the environmental category of the part.

Multiple part markings will be inside parentheses. Only one part marking contained in parentheses and separated by a "-" will appear on a part. If a line is indented then it is a continuation of the previous line and the two combined represent the entire part marking for that device.

**Important Information and Disclaimer:** The information provided on this page represents TI's knowledge and belief as of the date that it is provided. TI bases its knowledge and belief on information provided by third parties, and makes no representation or warranty as to the accuracy of such information. Efforts are underway to better integrate information from third parties. TI has taken and continues to take reasonable steps to provide representative and accurate information but may not have conducted destructive testing or chemical analysis on incoming materials and chemicals. TI and TI suppliers consider certain information to be proprietary, and thus CAS numbers and other limited information may not be available for release.

In no event shall TI's liability arising out of such information exceed the total purchase price of the TI part(s) at issue in this document sold by TI to Customer on an annual basis.

**OTHER QUALIFIED VERSIONS OF TPS7A88-Q1 :**

- Catalog : [TPS7A88](#)

NOTE: Qualified Version Definitions:

- Catalog - TI's standard catalog product



## TAPE AND REEL INFORMATION



### QUADRANT ASSIGNMENTS FOR PIN 1 ORIENTATION IN TAPE



\*All dimensions are nominal

Device	Package Type	Package Drawing	Pins	SPQ	Reel Diameter (mm)	Reel Width W1 (mm)	A0 (mm)	B0 (mm)	K0 (mm)	P1 (mm)	W (mm)	Pin1 Quadrant
TPS7A8801QRTJRQ1	QFN	RTJ	20	3000	330.0	12.4	4.3	4.3	1.1	8.0	12.0	Q2

**TAPE AND REEL BOX DIMENSIONS**

\*All dimensions are nominal

Device	Package Type	Package Drawing	Pins	SPQ	Length (mm)	Width (mm)	Height (mm)
TPS7A8801QRTJRQ1	QFN	RTJ	20	3000	367.0	367.0	38.0

## IMPORTANT NOTICE AND DISCLAIMER

TI PROVIDES TECHNICAL AND RELIABILITY DATA (INCLUDING DATASHEETS), DESIGN RESOURCES (INCLUDING REFERENCE DESIGNS), APPLICATION OR OTHER DESIGN ADVICE, WEB TOOLS, SAFETY INFORMATION, AND OTHER RESOURCES "AS IS" AND WITH ALL FAULTS, AND DISCLAIMS ALL WARRANTIES, EXPRESS AND IMPLIED, INCLUDING WITHOUT LIMITATION ANY IMPLIED WARRANTIES OF MERCHANTABILITY, FITNESS FOR A PARTICULAR PURPOSE OR NON-INFRINGEMENT OF THIRD PARTY INTELLECTUAL PROPERTY RIGHTS.

These resources are intended for skilled developers designing with TI products. You are solely responsible for (1) selecting the appropriate TI products for your application, (2) designing, validating and testing your application, and (3) ensuring your application meets applicable standards, and any other safety, security, regulatory or other requirements.

These resources are subject to change without notice. TI grants you permission to use these resources only for development of an application that uses the TI products described in the resource. Other reproduction and display of these resources is prohibited. No license is granted to any other TI intellectual property right or to any third party intellectual property right. TI disclaims responsibility for, and you fully indemnify TI and its representatives against any claims, damages, costs, losses, and liabilities arising out of your use of these resources.

TI's products are provided subject to [TI's Terms of Sale](#), [TI's General Quality Guidelines](#), or other applicable terms available either on [ti.com](http://ti.com) or provided in conjunction with such TI products. TI's provision of these resources does not expand or otherwise alter TI's applicable warranties or warranty disclaimers for TI products. Unless TI explicitly designates a product as custom or customer-specified, TI products are standard, catalog, general purpose devices.

TI objects to and rejects any additional or different terms you may propose.

Copyright © 2025, Texas Instruments Incorporated

Last updated 10/2025