

# 500-mA, HIGH-EFFICIENCY MicroSiP™ STEP-DOWN CONVERTER (PROFILE <1mm)

Check for Samples: [TPS82690](#), [TPS82695](#), [TPS82697](#)

## FEATURES

- Total Solution Size <math><6.7 \text{ mm}^2</math>
- 95% Efficiency at 4MHz Operation
- 24 $\mu\text{A}$  Quiescent Current
- High Duty-Cycle Operation
- *Best in Class* Load and Line Transient
- $\pm 2\%$  Total DC Voltage Accuracy
- Automatic PFM/PWM Mode Switching
- Low Ripple Light-Load PFM Mode
- Excellent AC Load Regulation
- Internal Soft Start, 130- $\mu\text{s}$  Start-Up Time
- Integrated Active Power-Down Sequencing (Optional)
- Current Overload and Thermal Shutdown Protection
- Sub 1-mm Profile Solution

## APPLICATIONS

- LDO Replacement
- Cell Phones, Smart-Phones
- PoL Applications

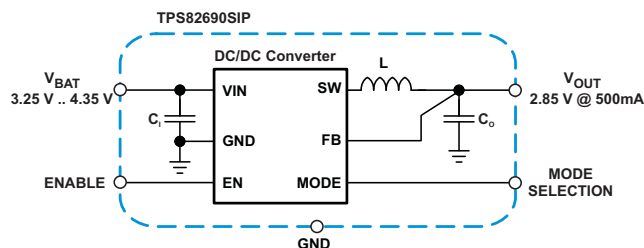

Figure 1. Typical Application

## DESCRIPTION

The TPS8269xSiP device is a complete 500mA, DC/DC step-down power supply intended for low-power applications. Included in the package are the switching regulator, inductor and input/output capacitors. No additional components are required to finish the design.

The TPS8269xSiP is based on a high-frequency synchronous step-down dc-dc converter optimized for battery-powered portable applications. The MicroSiP™ DC/DC converter operates at a regulated 4-MHz switching frequency and enters the power-save mode operation at light load currents to maintain high efficiency over the entire load current range.

The PFM mode extends the battery life by reducing the quiescent current to 24 $\mu\text{A}$  (typ) during light load operation. For noise-sensitive applications, the device has PWM spread spectrum capability providing a lower noise regulated output, as well as low noise at the input. These features, combined with high PSRR and AC load regulation performance, make this device suitable to replace a linear regulator to obtain better power conversion efficiency.

The TPS8269xSiP is packaged in a compact (2.3mm x 2.9mm) and low profile (1.0mm) BGA package suitable for automated assembly by standard surface mount equipment.

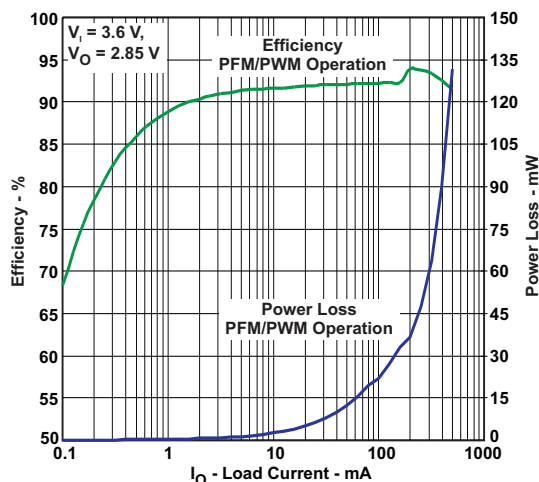

Figure 2. Efficiency vs. Load Current



Please be aware that an important notice concerning availability, standard warranty, and use in critical applications of Texas Instruments semiconductor products and disclaimers thereto appears at the end of this data sheet.

MicroSiP, MicroSiP are trademarks of Texas Instruments.



These devices have limited built-in ESD protection. The leads should be shorted together or the device placed in conductive foam during storage or handling to prevent electrostatic damage to the MOS gates.

### ORDERING INFORMATION<sup>(1)</sup>

T <sub>A</sub>	PART NUMBER	OUTPUT VOLTAGE <sup>(2)</sup>	DEVICE SPECIFIC FEATURE	ORDERING <sup>(3)</sup>	PACKAGE MARKING
-40°C to 85°C	TPS82695	2.5V		TPS82695SIP	UF
	TPS82690 <sup>(4)</sup>	2.85V		TPS82690SIP	RC
	TPS82696 <sup>(4)</sup>	2.9V		TPS82696SIP	
	TPS82697 <sup>(4)</sup>	2.8V		TPS82697SIP	

- (1) For the most current package and ordering information, see the Package Option Addendum at the end of this document, or see the TI website at [www.ti.com](http://www.ti.com).
- (2) Internal tap points are available to facilitate output voltages in 25mV increments.
- (3) The SIP package is available in tape and reel. Add a R suffix (e.g. TPS82690SIPR) to order quantities of 3000 parts. Add a T suffix (e.g. TPS82690SIPT) to order quantities of 250 parts.
- (4) Product preview. [Contact TI factory for more information](#)

### ABSOLUTE MAXIMUM RATINGS

over operating free-air temperature range (unless otherwise noted)<sup>(1)</sup>

		UNIT
V <sub>I</sub>	Voltage at VIN <sup>(2)(3)</sup>	-0.3 V to 6 V
	Voltage at VOUT <sup>(3)</sup>	-0.3 V to 3.6 V
	Voltage at EN, MODE <sup>(3)</sup>	-0.3 V to V <sub>I</sub> + 0.3 V
I <sub>O</sub>	Peak output current	500 mA
	Power dissipation	Internally limited
T <sub>A</sub>	Operating temperature range <sup>(4)</sup>	-40°C to 85°C
T <sub>INT</sub> (max)	Maximum internal operating temperature	125°C
T <sub>stg</sub>	Storage temperature range	-55°C to 125°C
ESD rating <sup>(5)</sup>	Human body model	2 kV
	Charge device model	1 kV
	Machine model	200 V

- (1) Stresses beyond those listed under *absolute maximum ratings* may cause permanent damage to the device. These are stress ratings only and functional operation of the device at these or any other conditions beyond those indicated under *recommended operating conditions* is not implied. Exposure to absolute-maximum-rated conditions for extended periods may affect device reliability.
- (2) Operation above 4.35V input voltage for extended periods may affect device reliability. See *input capacitor selection* section for more details.
- (3) All voltage values are with respect to network ground terminal.
- (4) In applications where high power dissipation and/or poor package thermal resistance is present, the maximum ambient temperature may have to be derated. Maximum ambient temperature (T<sub>A(max)</sub>) is dependent on the maximum operating temperature (T<sub>INT(max)</sub>), the maximum power dissipation of the device in the application (P<sub>D(max)</sub>), and the junction-to-ambient thermal resistance of the part/package in the application (θ<sub>JA</sub>), as given by the following equation: T<sub>A(max)</sub> = T<sub>J(max)</sub> - (θ<sub>JA</sub> × P<sub>D(max)</sub>). To achieve optimum performance, it is recommended to operate the device with a maximum internal temperature of 105°C.
- (5) The human body model is a 100-pF capacitor discharged through a 1.5-kΩ resistor into each pin. The machine model is a 200-pF capacitor discharged directly into each pin.

## THERMAL INFORMATION

THERMAL METRIC <sup>(1)</sup>		TPS82690/95/97	UNITS
		SIP (8-Pins)	
$\theta_{JA}$	Junction-to-ambient (top) thermal resistance	125	°C/W
	Junction-to-ambient (bottom) thermal resistance	70	
$\theta_{JCTop}$	Junction-to-case (top) thermal resistance	–	
$\theta_{JB}$	Junction-to-board thermal resistance	–	
$\psi_{JT}$	Junction-to-top characterization parameter	–	
$\psi_{JB}$	Junction-to-board characterization parameter	–	
$\theta_{JCbott}$	Junction-to-case (bottom) thermal resistance	–	

(1) For more information about traditional and new thermal metrics, see the *IC Package Thermal Metrics* application report, [SPRA953](#).

## RECOMMENDED OPERATING CONDITIONS

		MIN	NOM	MAX	UNIT
$V_I$	Input voltage range	2.3		4.35 <sup>(1)</sup>	V
$I_O$	Output current range	0		500	mA
	Additional output capacitance (PFM/PWM operation) <sup>(2)</sup>		0	5	$\mu$ F
	Additional output capacitance (PWM operation) <sup>(2)</sup>		0	8	$\mu$ F
$T_A$	Ambient temperature	–40		+85	°C
$T_J$	Operating junction temperature	–40		+125	°C

(1) Operation above 4.35V input voltage for extended periods may affect device reliability. See *input capacitor selection* section for more details.

(2) In certain applications larger capacitor values can be tolerable, see *output capacitor selection* section for more details.

## ELECTRICAL CHARACTERISTICS

Minimum and maximum values are at  $V_I = 2.3V$  to  $4.35V$ ,  $V_O = 2.5V$ ,  $EN = 1.8V$ , AUTO mode and  $T_A = -40^\circ C$  to  $85^\circ C$ ; Circuit of Parameter Measurement Information section (unless otherwise noted). Typical values are at  $V_I = 3.6V$ ,  $V_O = 2.5V$ ,  $EN = 1.8V$ , AUTO mode and  $T_A = 25^\circ C$  (unless otherwise noted).

PARAMETER		TEST CONDITIONS		MIN	TYP	MAX	UNIT	
<b>SUPPLY CURRENT</b>								
$I_Q$	Operating quiescent current	TPS82690	$I_O = 0mA$ . Device not switching		24	50	$\mu A$	
			$I_O = 0mA$ , PWM mode		4.5		mA	
$I_{SD}$	Shutdown current	TPS8269X	$EN = GND$		0.5	5	$\mu A$	
UVLO	Undervoltage lockout threshold	TPS82690 TPS82695 TPS82697			2.05	2.1	V	
		TPS82696			2.1	2.15	V	
<b>PROTECTION</b>								
	Thermal shutdown	TPS8269X			140		°C	
	Thermal shutdown hysteresis					10		°C
$I_{LIM}$	Peak input current limit	TPS8269X			750		mA	
$I_{SC}$	Input current limit under short-circuit conditions	TPS8269X	$V_O$ shorted to ground		15		mA	
<b>ENABLE, MODE</b>								
$V_{IH}$	High-level input voltage	TPS8269X		1.0			V	
$V_{IL}$	Low-level input voltage					0.4		V
	Input leakage current		Input connected to GND or VIN		0.01	1.5		$\mu A$
<b>OSCILLATOR</b>								
$f_{SW}$	Oscillator frequency	TPS8269X	$I_O = 0mA$ . PWM operation. $T_A = 25^\circ C$	3.6	4	4.4	MHz	

## ELECTRICAL CHARACTERISTICS (continued)

Minimum and maximum values are at  $V_I = 2.3V$  to  $4.35V$ ,  $V_O = 2.5V$ ,  $EN = 1.8V$ , AUTO mode and  $T_A = -40^\circ C$  to  $85^\circ C$ ; Circuit of Parameter Measurement Information section (unless otherwise noted). Typical values are at  $V_I = 3.6V$ ,  $V_O = 2.5V$ ,  $EN = 1.8V$ , AUTO mode and  $T_A = 25^\circ C$  (unless otherwise noted).

PARAMETER		TEST CONDITIONS		MIN	TYP	MAX	UNIT	
<b>OUTPUT</b>								
$V_{(OUT)}$	Regulated DC output voltage	TPS82690 TPS82697	$3.25V \leq V_I \leq 4.35V$ , $0mA \leq I_O \leq 500mA$ PFM/PWM operation	$0.98 \times V_{NOM}$	$V_{NOM}$	$1.04 \times V_{NOM}$	V	
			$3.25V \leq V_I \leq 4.35V$ , $0mA \leq I_O \leq 500mA$ Additional output capacitor, $C_O = 4.7\mu F$ 6.3V 0402 (muRata GRM155R60J475M) PFM/PWM operation	$0.98 \times V_{NOM}$	$V_{NOM}$	$1.03 \times V_{NOM}$	V	
			$3.25V \leq V_I \leq 5.5V$ , $0mA \leq I_O \leq 500mA$ PFM/PWM operation	$0.98 \times V_{NOM}$	$V_{NOM}$	$1.05 \times V_{NOM}$	V	
			$3.25V \leq V_I \leq 5.5V$ , $0mA \leq I_O \leq 500mA$ PWM operation	$0.98 \times V_{NOM}$	$V_{NOM}$	$1.02 \times V_{NOM}$	V	
		TPS82695	$3.0V \leq V_I \leq 4.35V$ , $0mA \leq I_O \leq 500mA$ PFM/PWM operation	$0.98 \times V_{NOM}$	$V_{NOM}$	$1.04 \times V_{NOM}$	V	
			$3.0V \leq V_I \leq 5.5V$ , $0mA \leq I_O \leq 500mA$ PFM/PWM operation	$0.97 \times V_{NOM}$	$V_{NOM}$	$1.05 \times V_{NOM}$	V	
			$3.0V \leq V_I \leq 5.5V$ , $0mA \leq I_O \leq 500mA$ PWM operation	$0.98 \times V_{NOM}$	$V_{NOM}$	$1.02 \times V_{NOM}$	V	
		TPS82696	$3.25V \leq V_I \leq 5.5V$ , $0mA \leq I_O \leq 500mA$ PFM/PWM operation	$0.97 \times V_{NOM}$	$V_{NOM}$	$1.05 \times V_{NOM}$	V	
			$3.25V \leq V_I \leq 4.35V$ , $0mA \leq I_O \leq 500mA$ Additional output capacitor, $C_O = 4.7\mu F$ 6.3V 0402 (muRata GRM155R60J475M) PFM/PWM operation	$0.97 \times V_{NOM}$	$V_{NOM}$	$1.04 \times V_{NOM}$	V	
			$3.25V \leq V_I \leq 5.5V$ , $0mA \leq I_O \leq 500mA$ PWM operation	$0.97 \times V_{NOM}$	$V_{NOM}$	$1.03 \times V_{NOM}$	V	
		Line regulation	TPS8269X	$V_I = V_O + 0.5V$ (min 3.25V) to 5.5V, $I_O = 200mA$		0.18		%/V
		Load regulation		$I_O = 0mA$ to 500 mA. PWM operation		-0.0002		%/mA
	Feedback input resistance	TPS8269X			480		k $\Omega$	
$r_{DS(on)}$	Input-to-output On-resistance	TPS8269X	$V_I = 3.25V$ . Device not switching		390		m $\Omega$	
$\Delta V_O$	Power-save mode ripple voltage	TPS8269X	$I_O = 1mA$		70		mV <sub>PP</sub>	
			$I_O = 1mA$ Additional output capacitor, $C_O = 4.7\mu F$ 6.3V 0402 (muRata GRM155R60J475M)		35		mV <sub>PP</sub>	
	Start-up time	TPS82690 TPS82696 TPS82697	$I_O = 0mA$ , Time from active EN to $V_O$		130		$\mu s$	
			Time from active EN to full load current operation permitted		350		$\mu s$	
$r_{DIS}$	Discharge resistor for power-down sequence	TPS8269X			100	150	$\Omega$	

### PIN ASSIGNMENTS

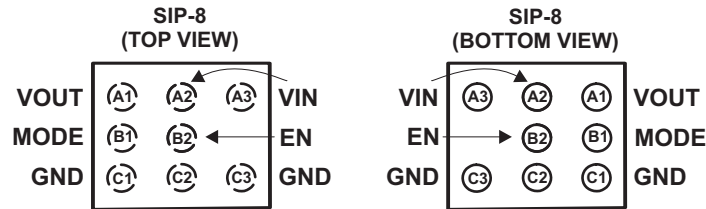

### TERMINAL FUNCTIONS

TERMINAL		I/O	DESCRIPTION
NAME	NO.		
VOUT	A1	O	Power output pin. Apply output load between this pin and GND.
VIN	A2, A3	I	The VIN pins supply current to the TPS8269xSIP's internal regulator.
EN	B2	I	This is the enable pin of the device. Connecting this pin to ground forces the converter into shutdown mode. Pulling this pin to $V_I$ enables the device. This pin must not be left floating and must be terminated.
MODE	B1	I	This is the mode selection pin of the device. This pin must not be left floating and must be terminated.
			MODE = LOW: The device is operating in regulated frequency pulse width modulation mode (PWM) at high-load currents and in pulse frequency modulation mode (PFM) at light load currents. MODE = HIGH: Low-noise mode enabled, regulated frequency PWM operation forced.
GND	C1, C2, C3	–	Ground pin.

### FUNCTIONAL BLOCK DIAGRAM

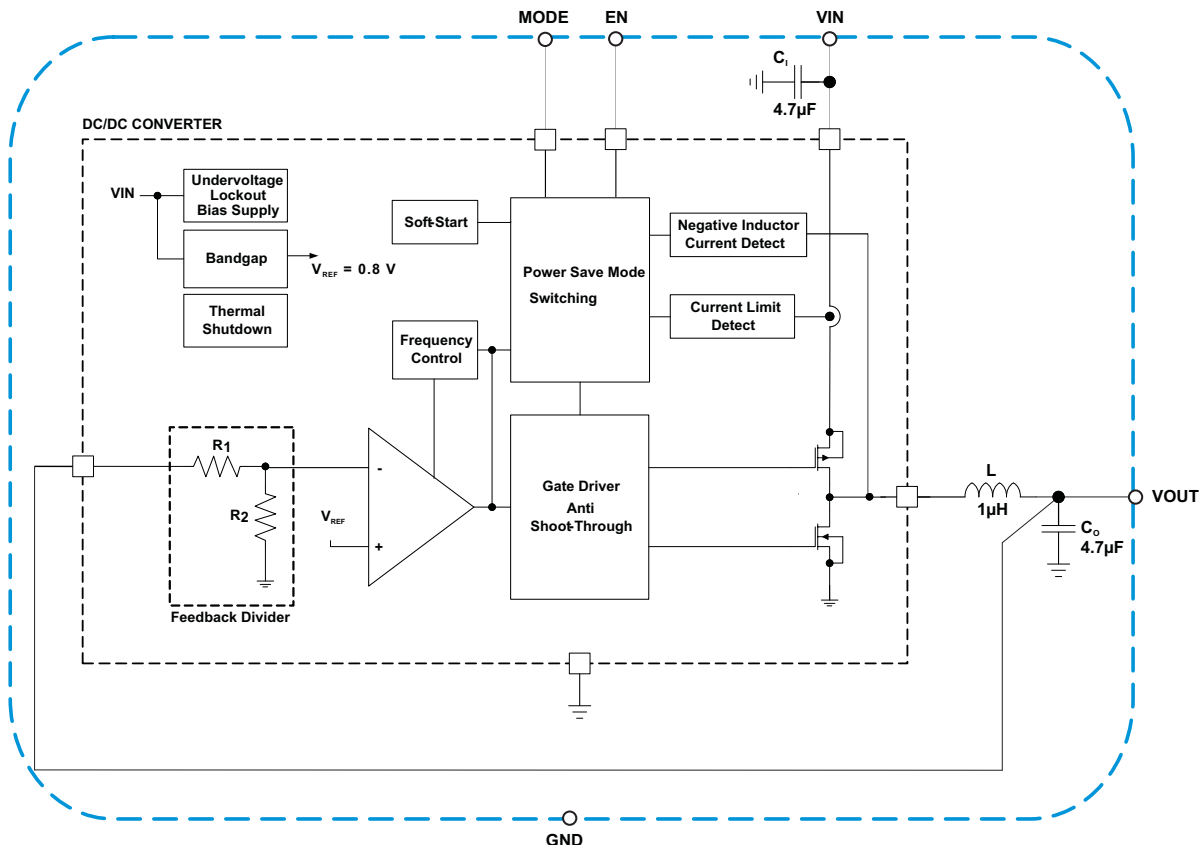

## PARAMETER MEASUREMENT INFORMATION

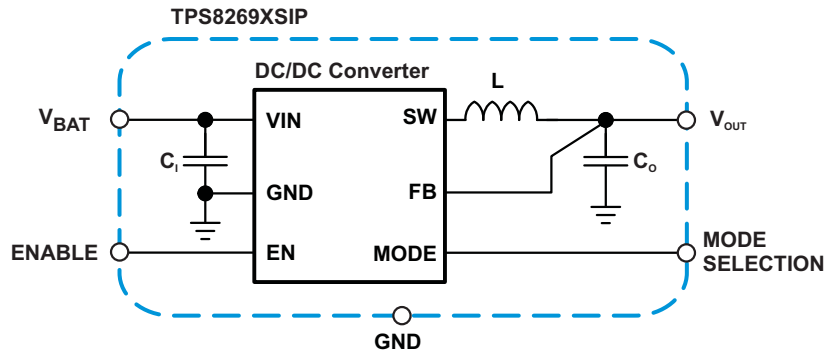

## TYPICAL CHARACTERISTICS

### Table of Graphs

			FIGURE
$\eta$	Efficiency	vs Load current	3, 4
		vs Load current	5, 6
		vs Input voltage	7
	Peak-to-peak output ripple voltage	vs Load current	8, 9
$V_O$	DC output voltage	vs Load current	10, 11, 120
	Combined line/load transient response		13, 14
	Load transient response		15, 16, 17, 18
	AC load transient response		19, 20, 21, 22, 23, 24, 25
	PFM/PWM boundaries	vs Input voltage	26
$I_Q$	Quiescent current	vs Input voltage	27
$f_s$	PWM switching frequency	vs Input voltage	28
	PFM switching frequency	vs Load current	29
	Start-up		30, 31
PSRR	Power supply rejection ratio	vs. Frequency	32

TYPICAL CHARACTERISTICS (continued)

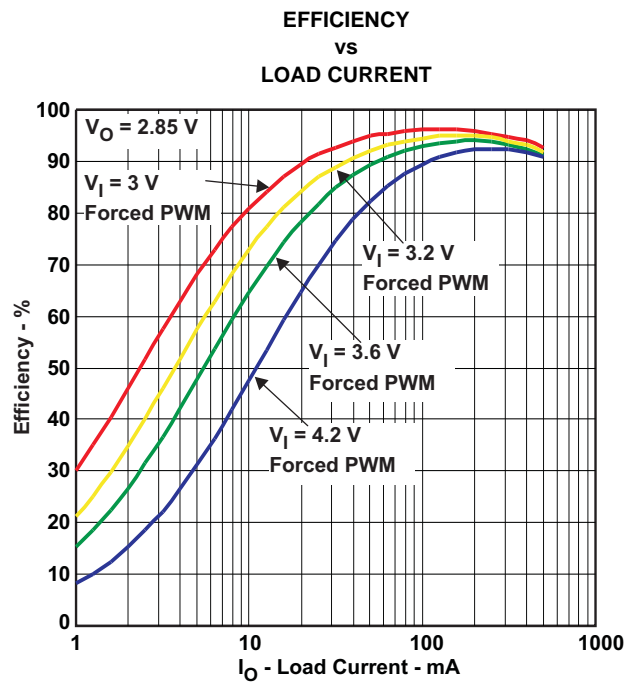
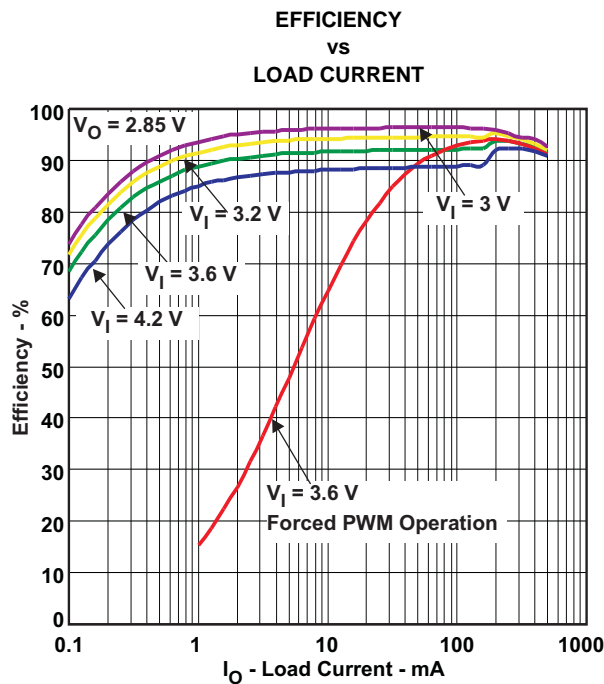
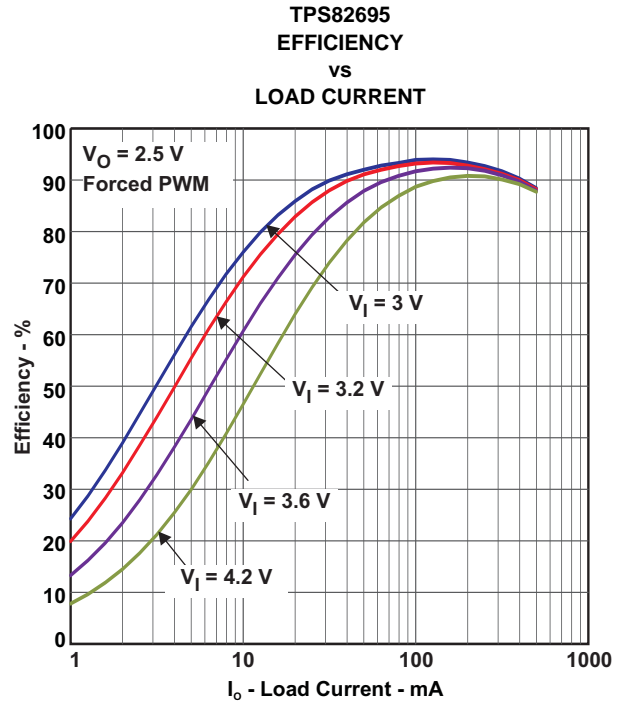
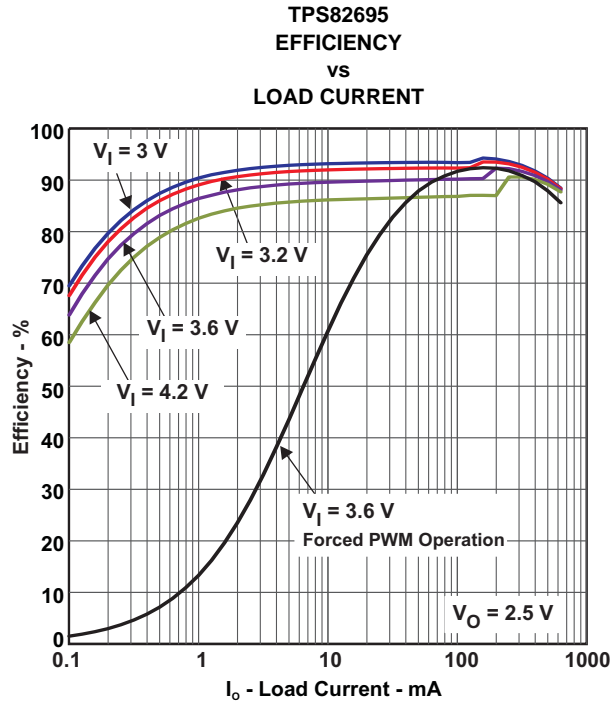

TYPICAL CHARACTERISTICS (continued)

EFFICIENCY  
 vs  
 INPUT VOLTAGE

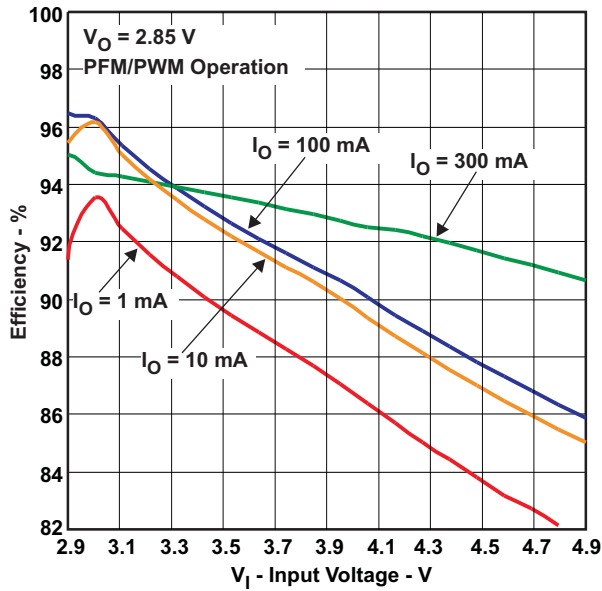

Figure 7.

PEAK-TO-PEAK OUTPUT RIPPLE VOLTAGE  
 vs  
 LOAD CURRENT

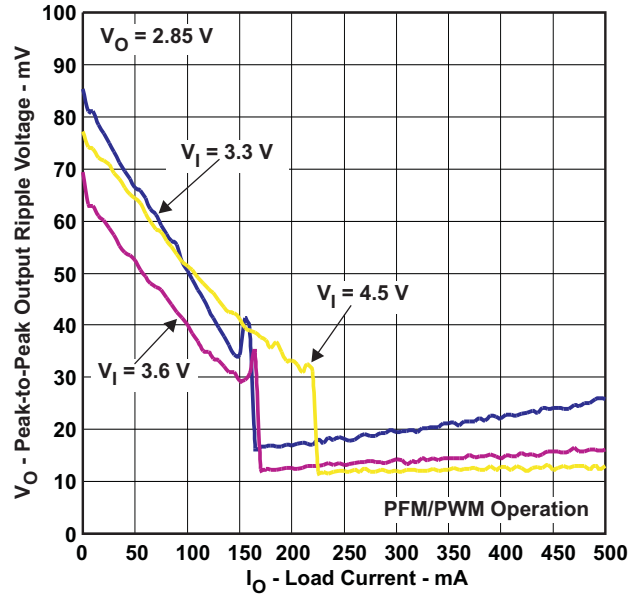

Figure 8.

PEAK-TO-PEAK OUTPUT RIPPLE VOLTAGE  
 vs  
 LOAD CURRENT

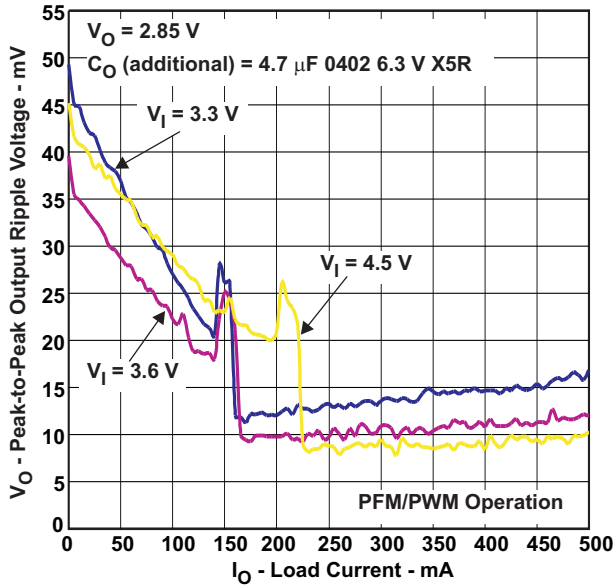

Figure 9.

DC OUTPUT VOLTAGE  
 vs  
 LOAD CURRENT

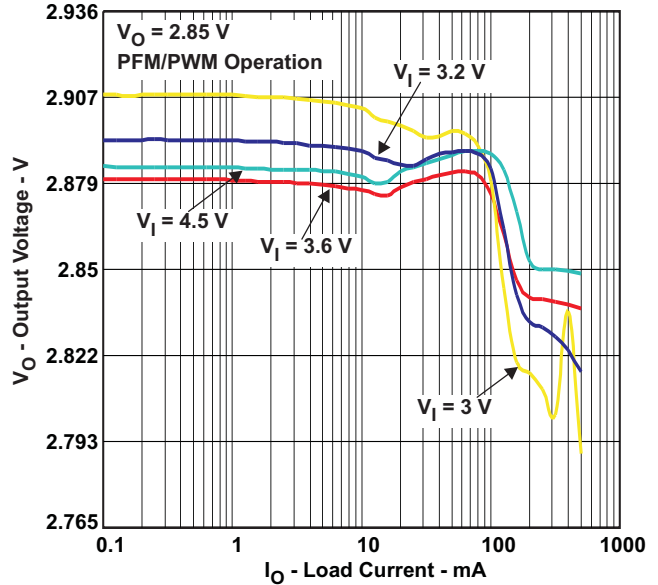

Figure 10.



TYPICAL CHARACTERISTICS (continued)

DC OUTPUT VOLTAGE vs LOAD CURRENT

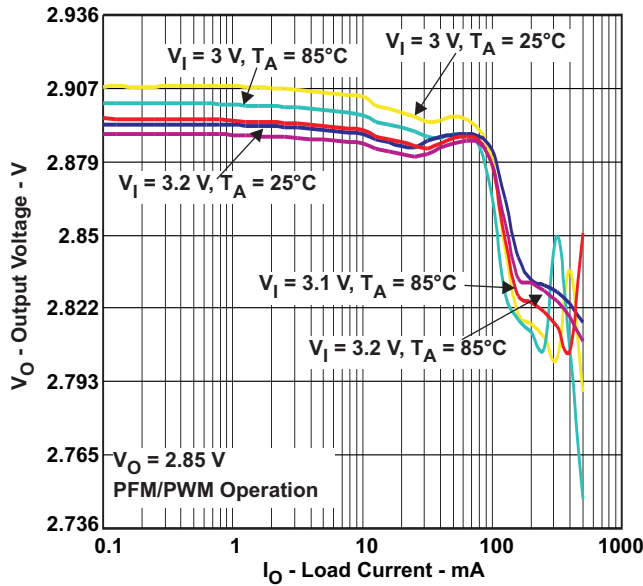

Figure 11.

DC OUTPUT VOLTAGE vs LOAD CURRENT

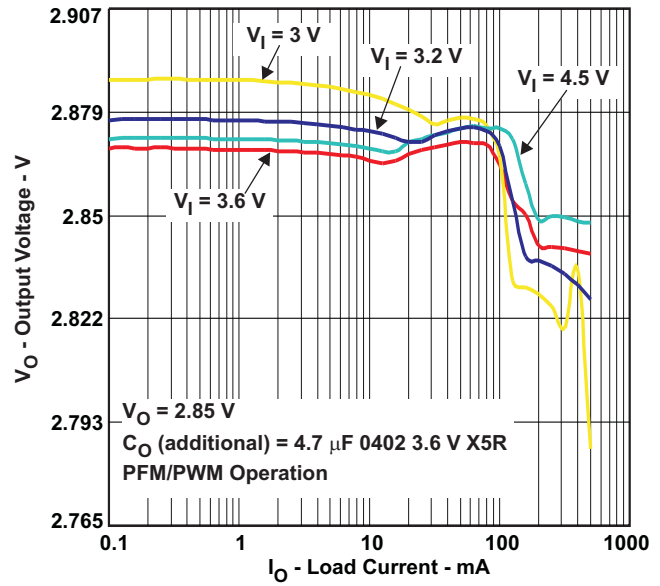

Figure 12.

COMBINED LINE/LOAD TRANSIENT RESPONSE

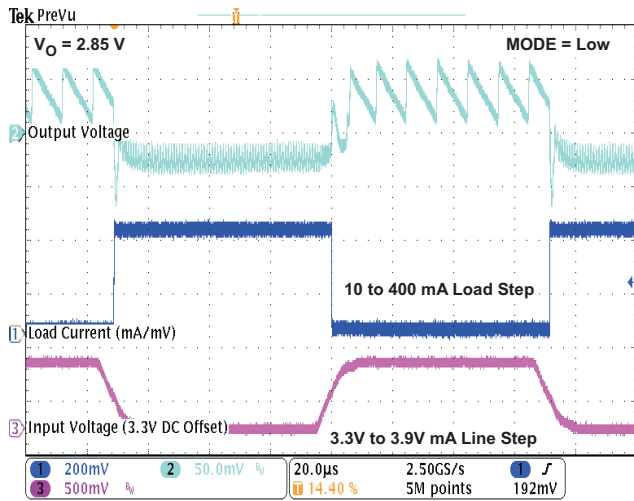

Figure 13.

COMBINED LINE/LOAD TRANSIENT RESPONSE

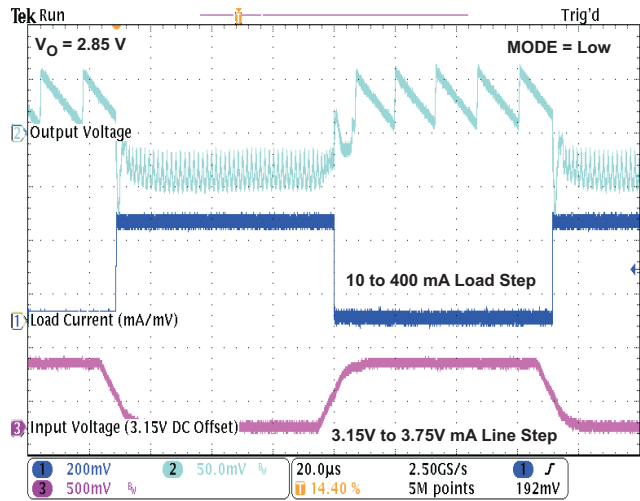

Figure 14.

TYPICAL CHARACTERISTICS (continued)

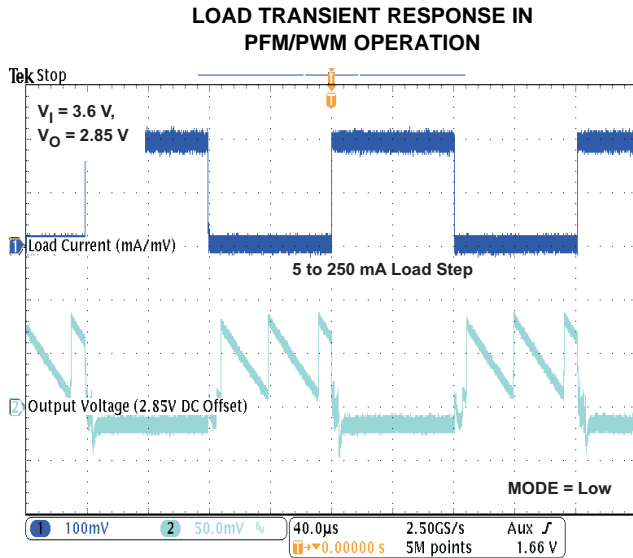

Figure 15.

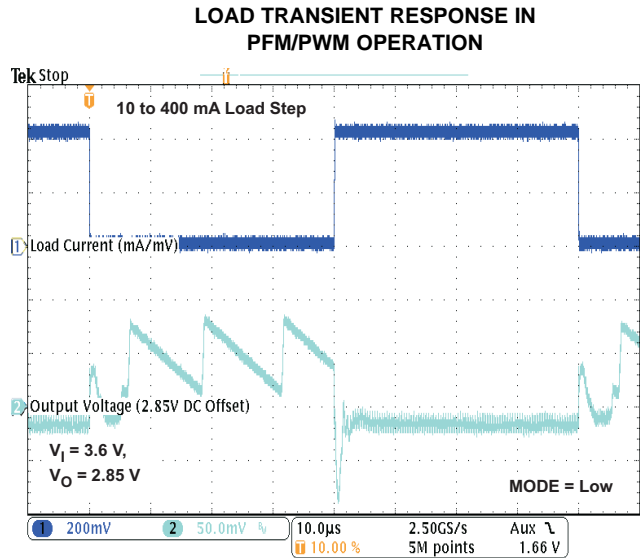

Figure 16.

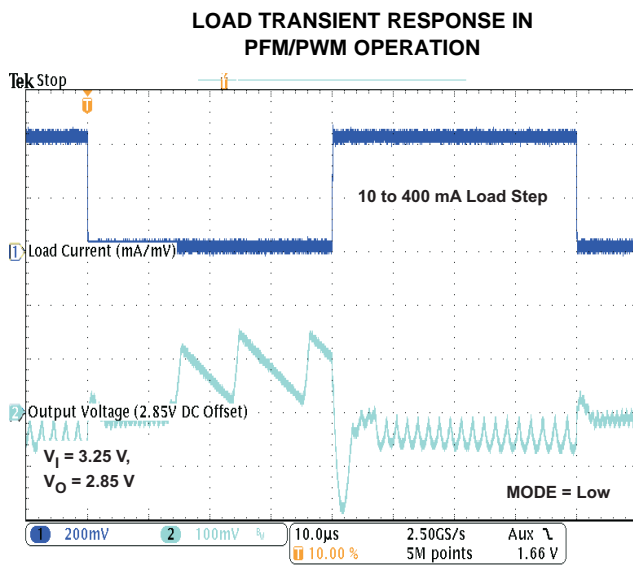

Figure 17.

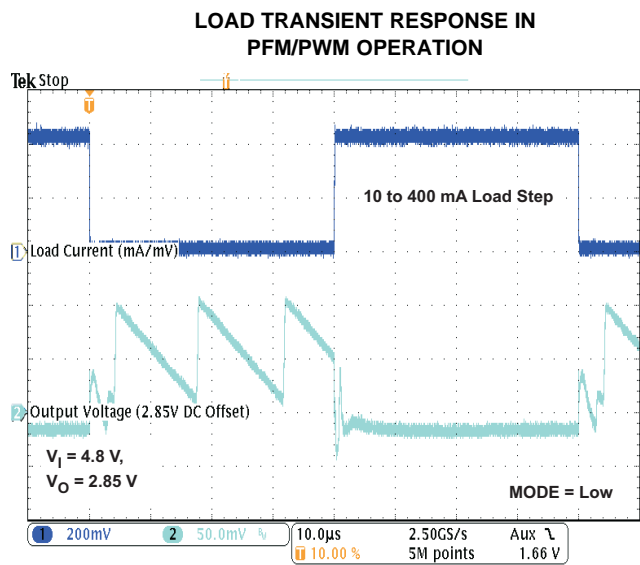

Figure 18.

TYPICAL CHARACTERISTICS (continued)

AC LOAD TRANSIENT RESPONSE

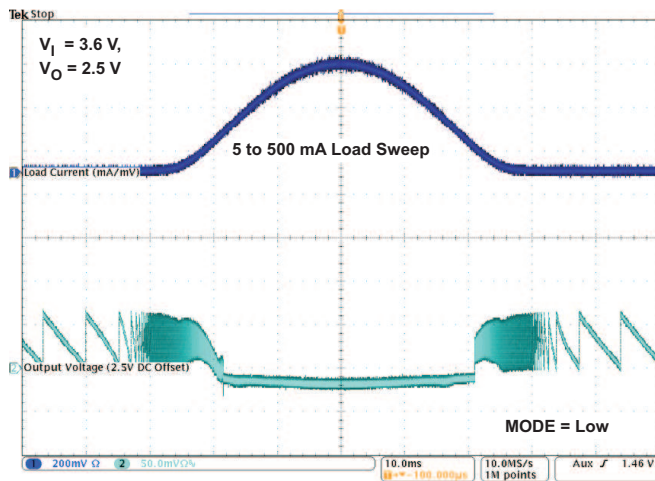

Figure 19.

AC LOAD TRANSIENT RESPONSE

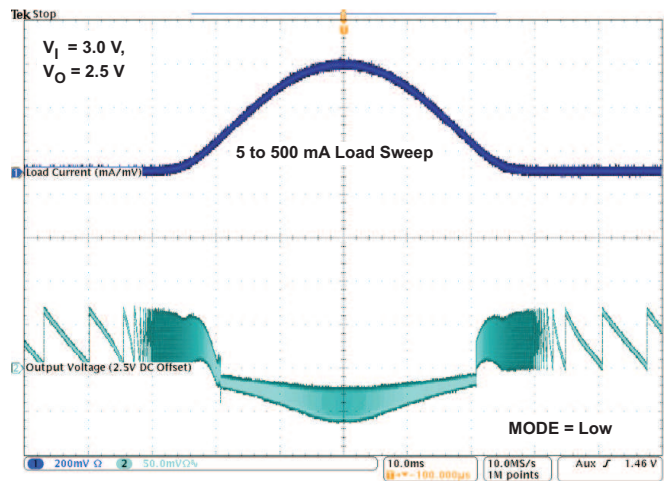

Figure 20.

AC LOAD TRANSIENT RESPONSE

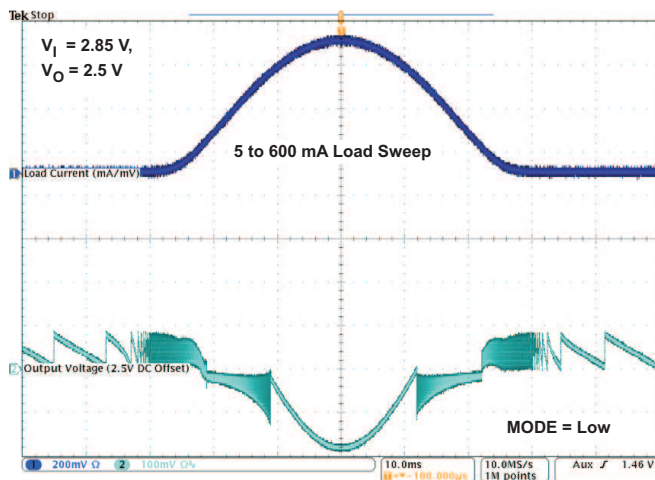

Figure 21.

AC LOAD TRANSIENT RESPONSE

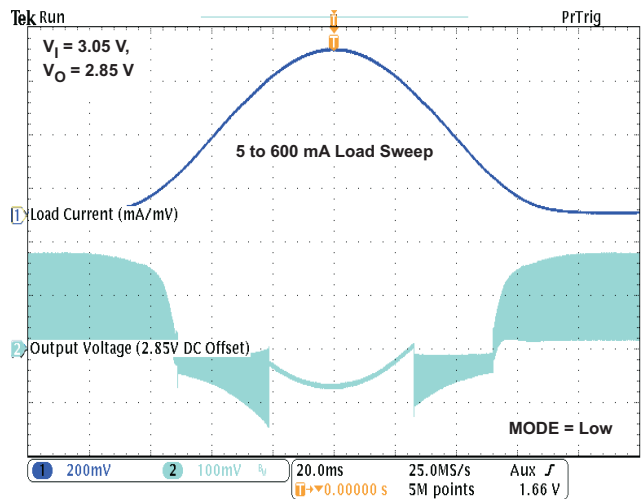

Figure 22.

TYPICAL CHARACTERISTICS (continued)

AC LOAD TRANSIENT RESPONSE

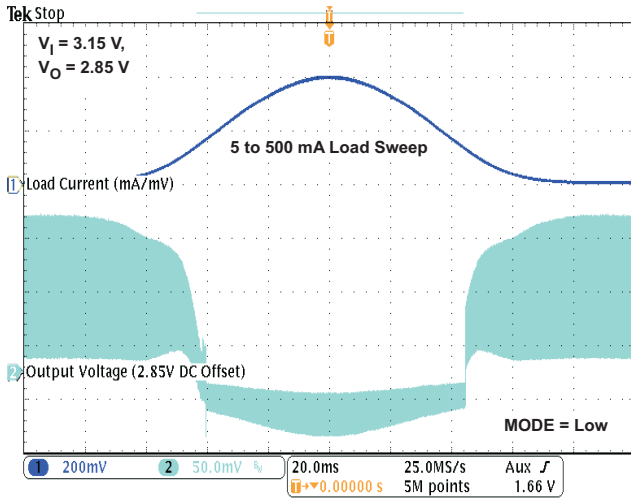

Figure 23.

AC LOAD TRANSIENT RESPONSE

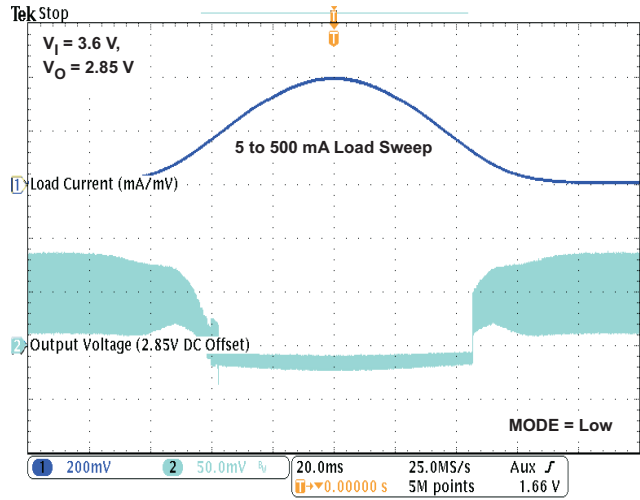

Figure 24.

AC LOAD TRANSIENT RESPONSE

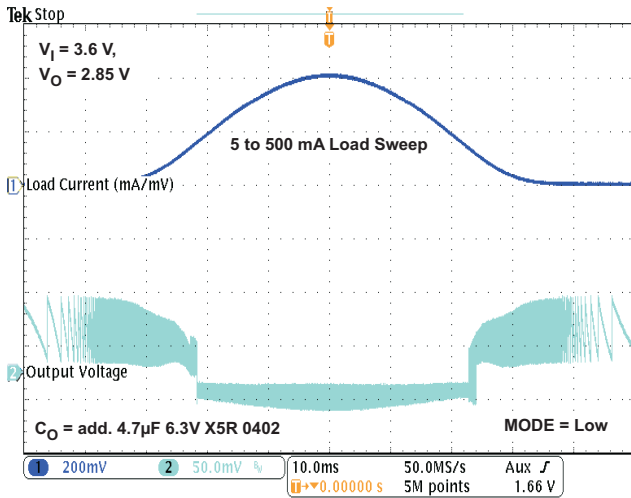

Figure 25.

PFM/PWM BOUNDARIES

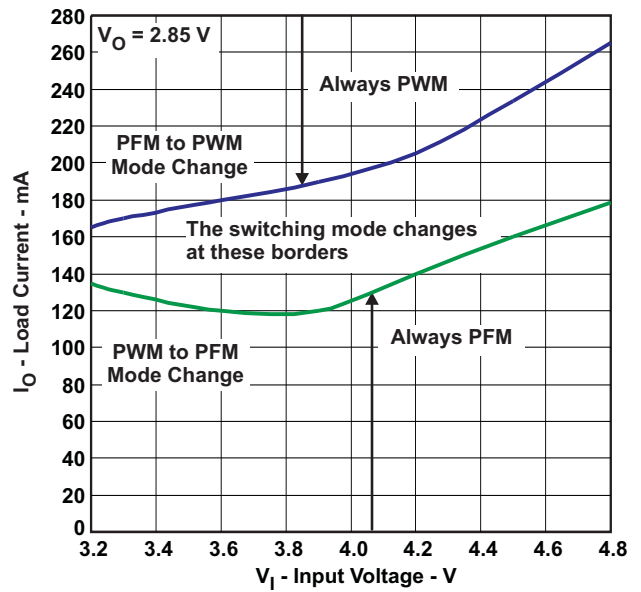

Figure 26.

TYPICAL CHARACTERISTICS (continued)

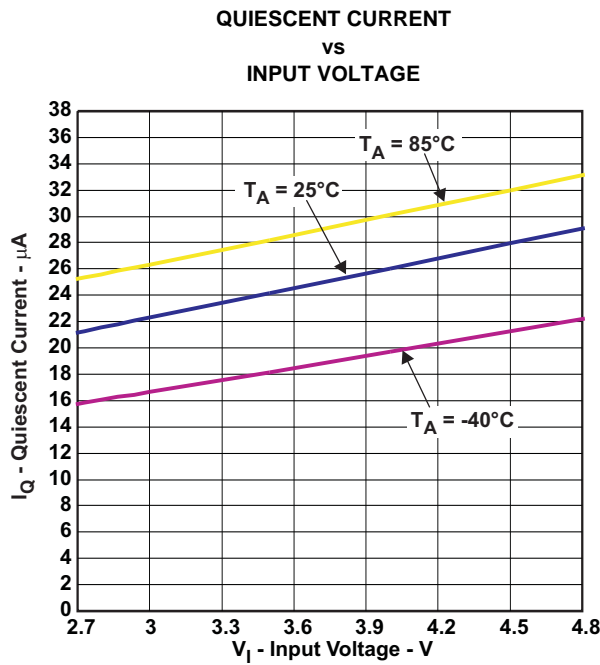

Figure 27.

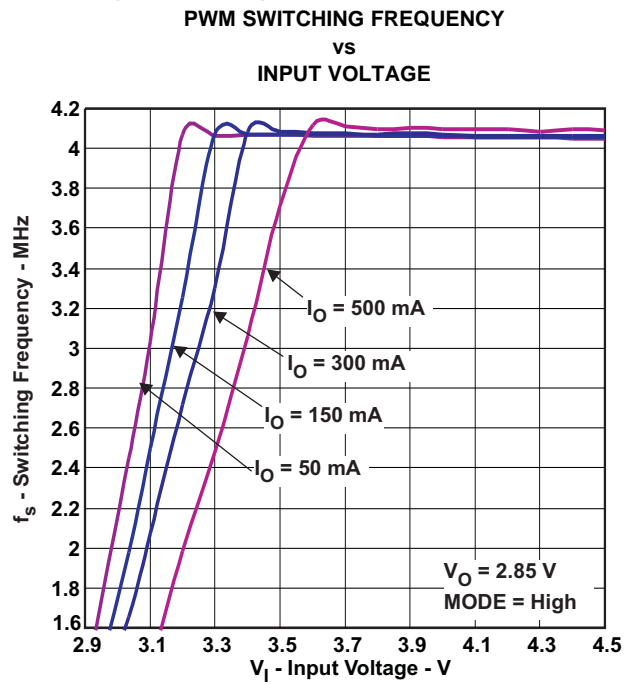

Figure 28.

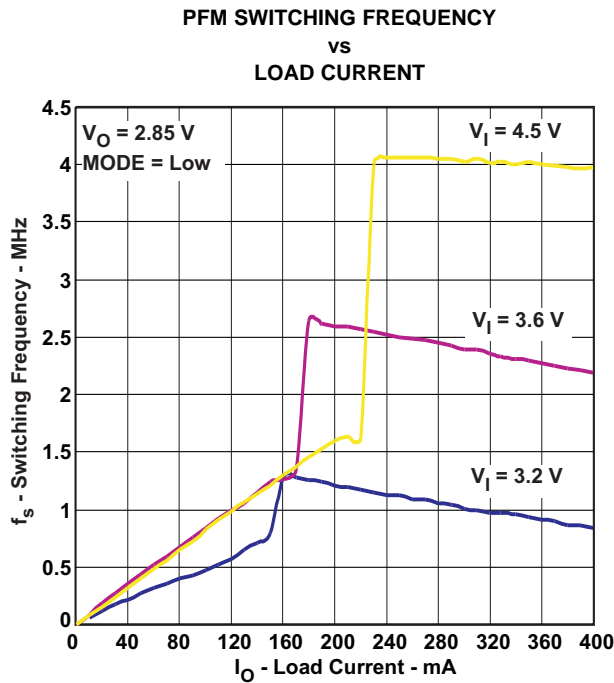

Figure 29.

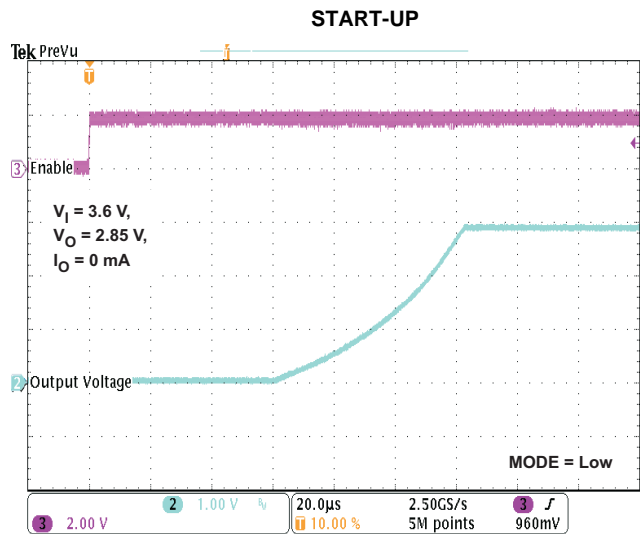

Figure 30.

TYPICAL CHARACTERISTICS (continued)

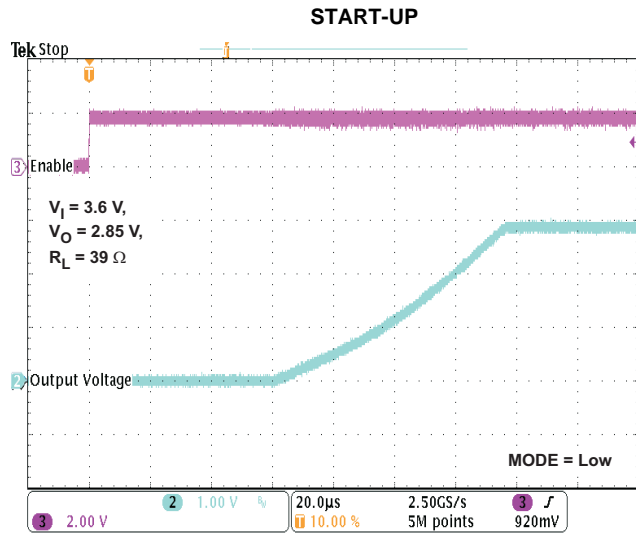

Figure 31.

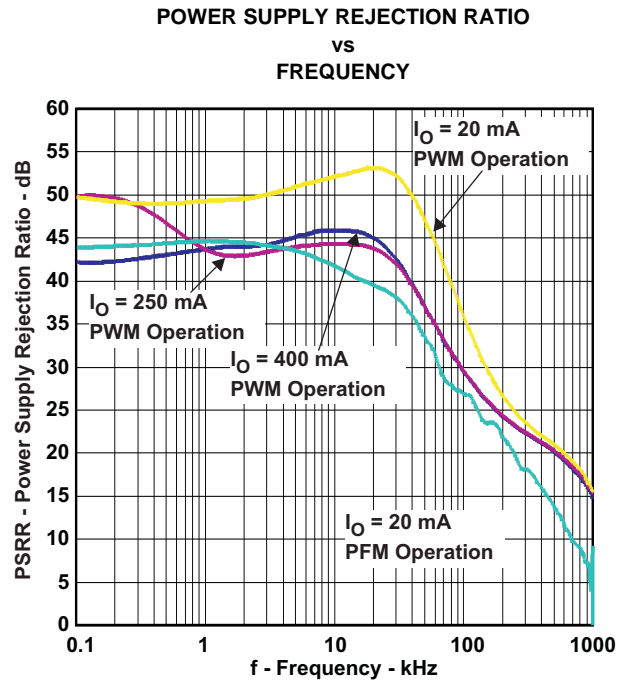

Figure 32.

## DETAILED DESCRIPTION

### OPERATION

The TPS8269xSIP is a standalone synchronous step-down converter operating at a regulated 4-MHz frequency pulse width modulation (PWM) at moderate to heavy load currents (up to 500mA output current). At light load currents, the TPS8269xSIP's converter operates in power-save mode with pulse frequency modulation (PFM).

The converter uses a unique frequency locked ring oscillating modulator to achieve *best-in-class* load and line response. One key advantage of the non-linear architecture is that there is no traditional feed-back loop. The loop response to change in  $V_O$  is essentially instantaneous, which explains the transient response. Although this type of operation normally results in a switching frequency that varies with input voltage and load current, an internal frequency lock loop (FLL) holds the switching frequency constant over a large range of operating conditions.

Combined with *best in class* load and line transient response characteristics, the low quiescent current of the device (ca. 24 $\mu$ A) allows to maintain high efficiency at light load, while preserving fast transient response for applications requiring tight output regulation.

The TPS8269xSIP integrates an input current limit to protect the device against heavy load or short circuits and features an undervoltage lockout circuit to prevent the device from misoperation at low input voltages.

### POWER-SAVE MODE

If the load current decreases, the converter will enter Power Save Mode operation automatically. During power-save mode the converter operates in discontinuous current (DCM) with a minimum of one pulse, which produces low output ripple compared with other PFM architectures.

When in power-save mode, the converter resumes its operation when the output voltage trips below the nominal voltage. It ramps up the output voltage with a minimum of one pulse and goes into power-save mode when the output voltage is within its regulation limits again.

PFM mode is left and PWM operation is entered as the output current can no longer be supported in PFM mode. As a consequence, the DC output voltage is typically positioned ca. 1.5% above the nominal output voltage and the transition between PFM and PWM is seamless.

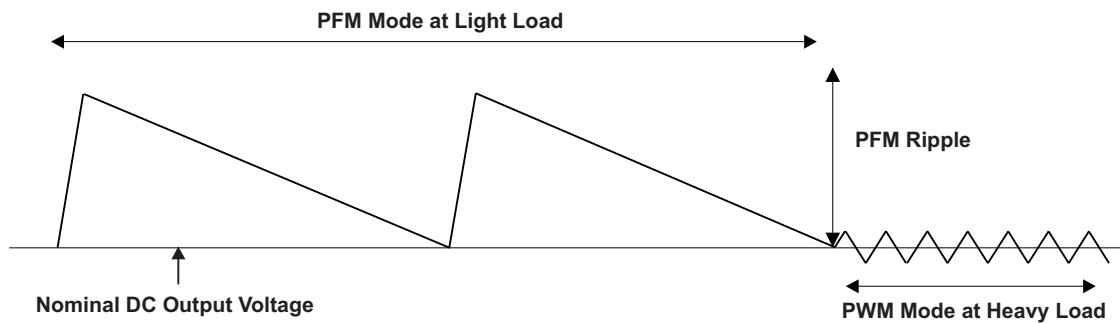

Figure 33. Operation in PFM Mode and Transfer to PWM Mode

## MODE SELECTION

The MODE pin allows to select the operating mode of the device. Connecting this pin to GND enables the automatic PWM and power-save mode operation. The converter operates in regulated frequency PWM mode at moderate to heavy loads and in the PFM mode during light loads, which maintains high efficiency over a wide load current range.

Pulling the MODE pin high forces the converter to operate in the PWM mode even at light load currents. The advantage is that the converter operates with a fixed frequency that allows simple filtering of the switching frequency for noise-sensitive applications. In this mode, the efficiency is lower compared to the power-save mode during light loads.

For additional flexibility, it is possible to switch from power-save mode to PWM mode during operation. This allows efficient power management by adjusting the operation of the converter to the specific system requirements.

## LOW DROPOUT, 100% DUTY CYCLE OPERATION

The device starts to enter 100% duty cycle mode once input and output voltage come close together. In order to maintain the output voltage, the DC/DC converter's high-side MOSFET is turned on 100% for one or more cycles.

With further decreasing  $V_{IN}$  the high-side switch is constantly turned on, thereby providing a low input-to-output voltage difference. This is particularly useful in battery-powered applications to achieve longest operation time by taking full advantage of the whole battery voltage range.

## SOFT START

The TPS8269xSIP has an internal soft-start circuit that limits the inrush current during start-up. This limits input voltage drops when a battery or a high-impedance power source is connected to the input of the MicroSiP™ converter.

The soft-start system progressively increases the switching on-time from a minimum pulse-width of 35ns as a function of the output voltage. This mode of operation continues for c.a. 100µs after enable. Should the output voltage not have reached its target value by that time, such as in the case of heavy load, the soft-start transitions to a second mode of operation.

If the output voltage has raised above 0.5V (approximately), the converter increases the input current limit thereby enabling the power supply to come-up properly. The start-up time mainly depends on the capacitance present at the output node and load current.

## ENABLE

The TPS8269xSIP device starts operation when EN is set high and starts up with the soft start as previously described. For proper operation, the EN pin must be terminated and must not be left floating.

Pulling the EN pin low forces the device into shutdown. In this mode, all internal circuits are turned off and  $V_{IN}$  current reduces to the device leakage current, typically a few hundred nanoamps.

The TPS8269xSIP device can actively discharge the output capacitor when it turns off (refer to Ordering Information Table). The integrated discharge resistor has a typical resistance of 100 Ω. The required time to ramp-down the output voltage depends on the load current and the capacitance present at the output node.



## APPLICATION INFORMATION

### INPUT CAPACITOR SELECTION

Because of the pulsating input current nature of the buck converter, a low ESR input capacitor is required to prevent large voltage transients that can cause misbehavior of the device or interference in other circuits in the system.

For most applications, the input capacitor that is integrated into the TPS8269x should be sufficient. If the application exhibits a noisy or erratic switching frequency, experiment with additional input ceramic capacitance to find a remedy.

The TPS8269x uses a tiny ceramic input capacitor. When a ceramic capacitor is combined with trace or cable inductance, such as from a wall adapter, a load step at the output can induce ringing at the VIN pin. This ringing can couple to the output and be mistaken as loop instability or can even damage the part. In this circumstance, additional "bulk" capacitance, such as electrolytic or tantalum, should be placed between the input of the converter and the power source lead to reduce ringing that can occur between the inductance of the power source leads and  $C_I$ .

### OUTPUT CAPACITOR SELECTION

The advanced, fast-response, voltage mode, control scheme of the TPS8269x allows the use of a tiny ceramic output capacitor ( $C_O$ ). For most applications, the output capacitor integrated in the TPS8269x is sufficient.

At nominal load current, the device operates in PWM mode; the overall output voltage ripple is the sum of the voltage step that is caused by the output capacitor ESL and the ripple current that flows through the output capacitor impedance. At light loads, the output capacitor limits the output ripple voltage and provides holdup during large load transitions.

The TPS8269x is designed as a Point-Of-Load (POL) regulator, to operate stand-alone without requiring any additional capacitance. Adding a 4.7 $\mu$ F ceramic output capacitor (X7R or X5R dielectric) generally works from a converter stability point of view, helps to minimize the output ripple voltage in PFM mode and improves the converter's transient response under when input and output voltage are close together.

For best operation (i.e. optimum efficiency over the entire load current range, proper PFM/PWM auto transition), the TPS8269xSiP requires a minimum output ripple voltage in PFM mode. The typical output voltage ripple is ca. 1% of the nominal output voltage  $V_O$ . The PFM pulses are time controlled resulting in a PFM output voltage ripple and PFM frequency that depends (first order) on the capacitance seen at the MicroSiP™ DC/DC converter's output.

In applications requiring additional output bypass capacitors located close to the load, care should be taken to ensure proper operation. If the converter exhibits marginal stability or erratic switching frequency, experiment with additional low value series resistance (e.g. 50 to 100m $\Omega$ ) in the output path to find a remedy.

Because the damping factor in the output path is directly related to several resistive parameters (e.g. inductor DCR, power-stage  $r_{DS(on)}$ , PWB DC resistance, load switches  $r_{DS(on)}$  ...) that are temperature dependant, the converter small and large signal behavior must be checked over the input voltage range, load current range and temperature range.

The easiest sanity test is to evaluate, directly at the converter's output, the following aspects:

- PFM/PWM efficiency
- PFM/PWM and forced PWM load transient response

During the recovery time from a load transient, the output voltage can be monitored for settling time, overshoot or ringing that helps judge the converter's stability. Without any ringing, the loop has usually more than 45° of phase margin.

## LAYOUT CONSIDERATION

In making the pad size for the SiP LGA balls, it is recommended that the layout use non-solder-mask defined (NSMD) land. With this method, the solder mask opening is made larger than the desired land area, and the opening size is defined by the copper pad width. Figure 34 shows the appropriate diameters for a MicroSiP™ layout.

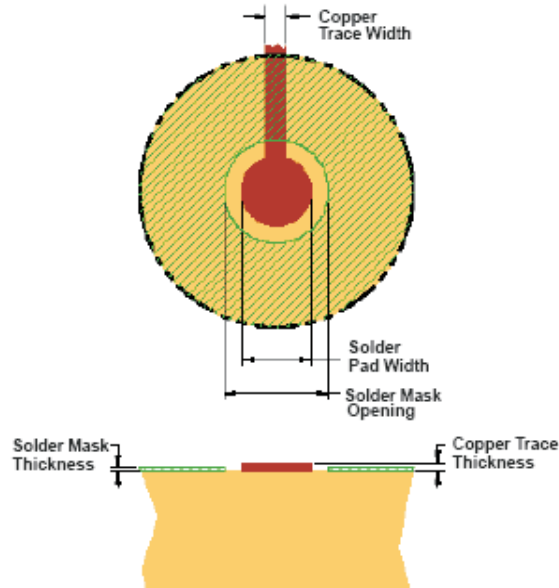

Figure 34. Recommended Land Pattern Image and Dimensions

SOLDER PAD DEFINITIONS (1)(2)(3)(4)	COPPER PAD	SOLDER MASK (5) OPENING	COPPER THICKNESS	STENCIL (6) OPENING	STENCIL THICKNESS
Non-solder-mask defined (NSMD)	0.30mm	0.360mm	1oz max (0.032mm)	0.34mm diameter	0.1mm thick

- (1) Circuit traces from non-solder-mask defined PWB lands should be 75µm to 100µm wide in the exposed area inside the solder mask opening. Wider trace widths reduce device stand off and affect reliability.
- (2) Best reliability results are achieved when the PWB laminate glass transition temperature is above the operating the range of the intended application.
- (3) Recommend solder paste is Type 3 or Type 4.
- (4) For a PWB using a Ni/Au surface finish, the gold thickness should be less than 0.5µm to avoid a reduction in thermal fatigue performance.
- (5) Solder mask thickness should be less than 20 µm on top of the copper circuit pattern.
- (6) For best solder stencil performance use laser cut stencils with electro polishing. Chemically etched stencils give inferior solder paste volume control.

## SURFACE MOUNT INFORMATION

The TPS8269x MicroSiP™ DC/DC converter uses an open frame construction that is designed for a fully automated assembly process and that features a large surface area for pick and place operations. See the "Pick Area" in the package drawings.

Package height and weight have been kept to a minimum thereby to allow the MicroSiP™ device to be handled similarly to a 0805 component.

See JEDEC/IPC standard J-STD-20b for reflow recommendations.

## THERMAL INFORMATION

The die temperature of the TPS8269x must be lower than the maximum rating of 125°C, so care should be taken in the layout of the circuit to ensure good heat sinking of the TPS8269x.

To estimate the junction temperature, approximate the power dissipation within the TPS8269x by applying the typical efficiency stated in this datasheet to the desired output power; or, by taking a power measurement if you have an actual TPS8269x device and TPS8269xEVM evaluation module. Then calculate the internal temperature rise of the TPS8269x above the surface of the printed circuit board by multiplying the TPS8269x power dissipation by the thermal resistance.

The actual thermal resistance of the TPS8269x to the printed circuit board depends on the layout of the circuit board, but the thermal resistance given in the Thermal Information Table can be used as a guide.

Three basic approaches for enhancing thermal performance are listed below:

- Improve the power dissipation capability of the PCB design.
- Improve the thermal coupling of the component to the PCB.
- Introduce airflow into the system.

## PACKAGE SUMMARY

### SIP PACKAGE

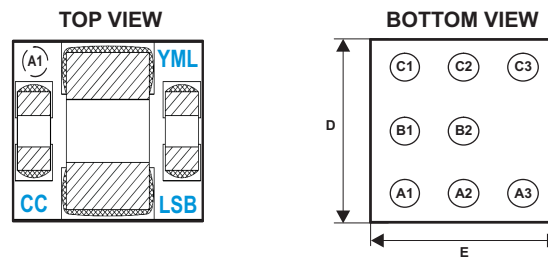

Code:

- CC — Customer Code (device/voltage specific)
- YML — Y: Year, M: Month, L: Lot trace code
- LSB — L: Lot trace code, S: Site code, B: Board locator

## MicroSiP™ DC/DC MODULE PACKAGE DIMENSIONS

The TPS8269x device is available in an 8-bump ball grid array (BGA) package. The package dimensions are:

- D = 2.30 ±0.05 mm
- E = 2.90 ±0.05 mm

Note: Page numbers of current version may differ from previous versions.

---

**Changes from Original (June 2011) to Revision A** **Page**

- Deleted Product Preview status from TPS82695 device in Ordering Information table. .... **2**

---

**Changes from Revision A (October 2011) to Revision B** **Page**

- Added device number TPS82697 ..... **1**
- Added Efficiency vs Load Current Graphs. [Figure 3](#) and [Figure 4](#) ..... **6**

**PACKAGING INFORMATION**

Orderable part number	Status (1)	Material type (2)	Package   Pins	Package qty   Carrier	RoHS (3)	Lead finish/ Ball material (4)	MSL rating/ Peak reflow (5)	Op temp (°C)	Part marking (6)
<a href="#">TPS82695SIPR</a>	Active	Production	uSiP (SIP)   8	3000   LARGE T&R	Yes	SNAGCU	Level-2-260C-1 YEAR	-40 to 85	UF
TPS82695SIPR.A	Active	Production	uSiP (SIP)   8	3000   LARGE T&R	Yes	SNAGCU	Level-2-260C-1 YEAR	-40 to 125	UF
<a href="#">TPS82695SIPT</a>	Active	Production	uSiP (SIP)   8	250   SMALL T&R	Yes	SNAGCU	Level-2-260C-1 YEAR	-40 to 85	UF
TPS82695SIPT.A	Active	Production	uSiP (SIP)   8	250   SMALL T&R	Yes	SNAGCU	Level-2-260C-1 YEAR	-40 to 125	UF

(1) **Status:** For more details on status, see our [product life cycle](#).

(2) **Material type:** When designated, preproduction parts are prototypes/experimental devices, and are not yet approved or released for full production. Testing and final process, including without limitation quality assurance, reliability performance testing, and/or process qualification, may not yet be complete, and this item is subject to further changes or possible discontinuation. If available for ordering, purchases will be subject to an additional waiver at checkout, and are intended for early internal evaluation purposes only. These items are sold without warranties of any kind.

(3) **RoHS values:** Yes, No, RoHS Exempt. See the [TI RoHS Statement](#) for additional information and value definition.

(4) **Lead finish/Ball material:** Parts may have multiple material finish options. Finish options are separated by a vertical ruled line. Lead finish/Ball material values may wrap to two lines if the finish value exceeds the maximum column width.

(5) **MSL rating/Peak reflow:** The moisture sensitivity level ratings and peak solder (reflow) temperatures. In the event that a part has multiple moisture sensitivity ratings, only the lowest level per JEDEC standards is shown. Refer to the shipping label for the actual reflow temperature that will be used to mount the part to the printed circuit board.

(6) **Part marking:** There may be an additional marking, which relates to the logo, the lot trace code information, or the environmental category of the part.

Multiple part markings will be inside parentheses. Only one part marking contained in parentheses and separated by a "~" will appear on a part. If a line is indented then it is a continuation of the previous line and the two combined represent the entire part marking for that device.

**Important Information and Disclaimer:** The information provided on this page represents TI's knowledge and belief as of the date that it is provided. TI bases its knowledge and belief on information provided by third parties, and makes no representation or warranty as to the accuracy of such information. Efforts are underway to better integrate information from third parties. TI has taken and continues to take reasonable steps to provide representative and accurate information but may not have conducted destructive testing or chemical analysis on incoming materials and chemicals. TI and TI suppliers consider certain information to be proprietary, and thus CAS numbers and other limited information may not be available for release.

In no event shall TI's liability arising out of such information exceed the total purchase price of the TI part(s) at issue in this document sold by TI to Customer on an annual basis.

**TAPE AND REEL INFORMATION**

**QUADRANT ASSIGNMENTS FOR PIN 1 ORIENTATION IN TAPE**

\*All dimensions are nominal

Device	Package Type	Package Drawing	Pins	SPQ	Reel Diameter (mm)	Reel Width W1 (mm)	A0 (mm)	B0 (mm)	K0 (mm)	P1 (mm)	W (mm)	Pin1 Quadrant
TPS82695SIPR	uSiP	SIP	8	3000	178.0	9.0	2.45	3.05	1.1	4.0	8.0	Q2
TPS82695SIPT	uSiP	SIP	8	250	178.0	9.0	2.45	3.05	1.1	4.0	8.0	Q2

**TAPE AND REEL BOX DIMENSIONS**

\*All dimensions are nominal

Device	Package Type	Package Drawing	Pins	SPQ	Length (mm)	Width (mm)	Height (mm)
TPS82695SIPR	uSiP	SIP	8	3000	223.0	194.0	35.0
TPS82695SIPT	uSiP	SIP	8	250	223.0	194.0	35.0



# PACKAGE OUTLINE

## SIP0008A

### MicroSiP™ - 1 mm max height

MICRO SYSTEM IN PACKAGE

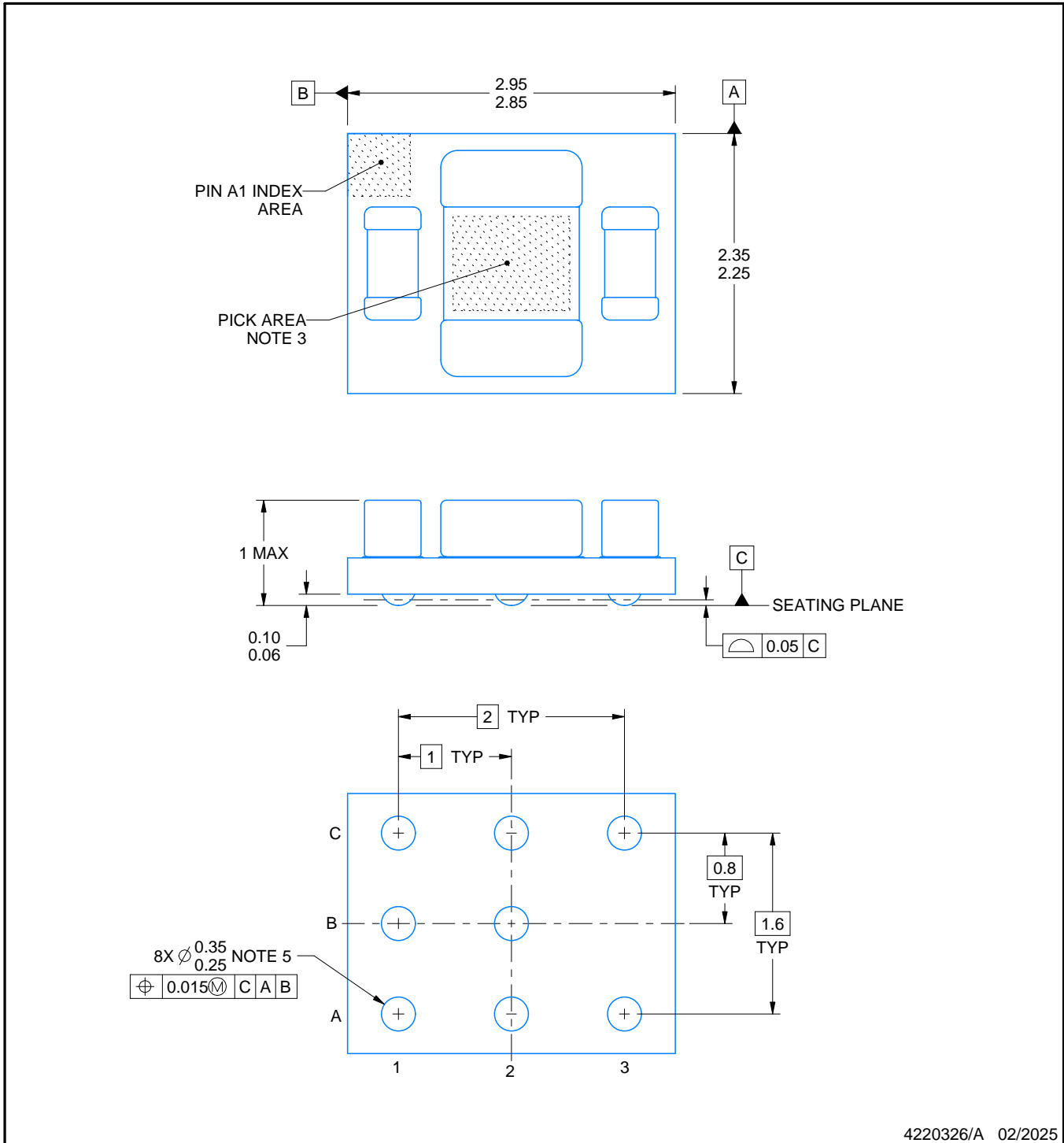

4220326/A 02/2025

MicroSiP is a trademark of Texas Instruments.

#### NOTES:

1. All linear dimensions are in millimeters. Any dimensions in parenthesis are for reference only. Dimensioning and tolerancing per ASME Y14.5M.
2. This drawing is subject to change without notice.
3. For pick and place nozzle recommendation, see product datasheet.
4. Location, size and quantity of each component are for reference only and may vary.
5. This package contains Pb-free balls.



# EXAMPLE BOARD LAYOUT

SIP0008A

MicroSiP™ - 1 mm max height

MICRO SYSTEM IN PACKAGE

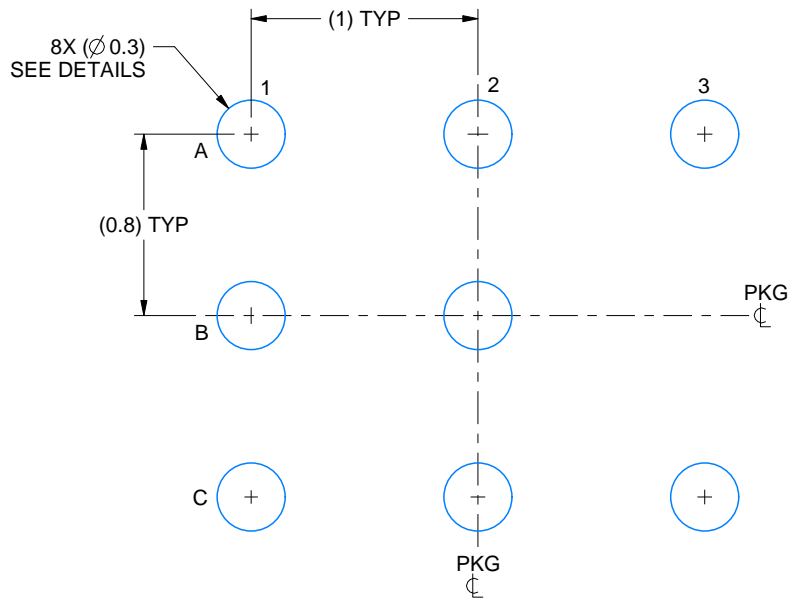

LAND PATTERN EXAMPLE  
EXPOSED METAL SHOWN  
SCALE: 30X

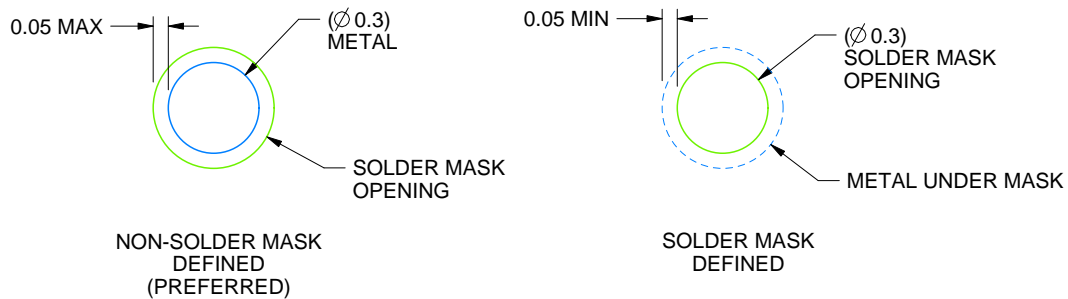

SOLDER MASK DETAILS  
NOT TO SCALE

4220326/A 02/2025

NOTES: (continued)

6. For more information, see Texas Instruments literature number SBVA017 ([www.ti.com/lit/sbva017](http://www.ti.com/lit/sbva017)).

# EXAMPLE STENCIL DESIGN

SIP0008A

MicroSiP™ - 1 mm max height

MICRO SYSTEM IN PACKAGE

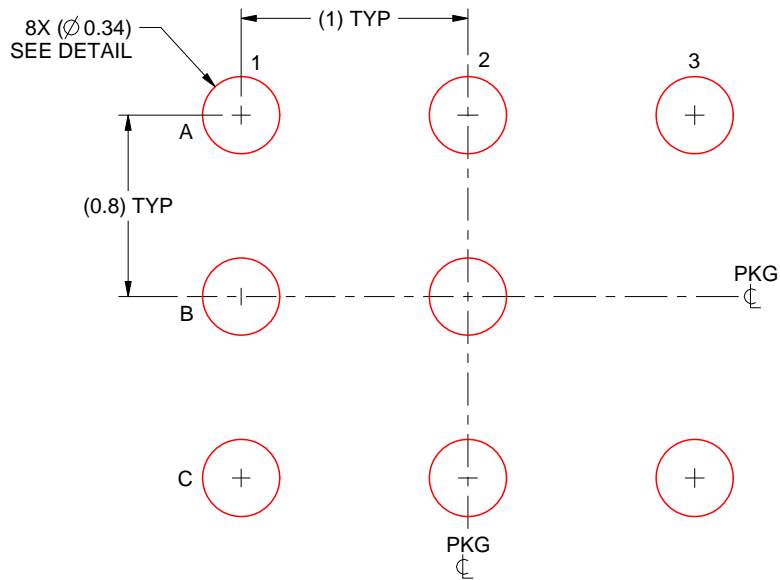

SOLDER PASTE EXAMPLE  
BASED ON 0.1 mm THICK STENCIL  
SCALE:30X

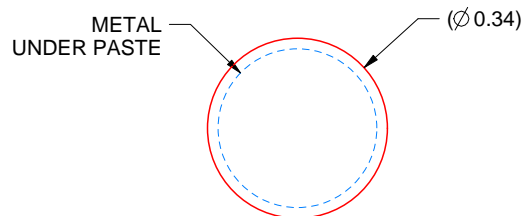

SOLDER PASTE DETAIL  
TYPICAL

4220326/A 02/2025

NOTES: (continued)

7. Laser cutting apertures with trapezoidal walls and rounded corners may offer better paste release. IPC-7525 may have alternate design recommendations.

## IMPORTANT NOTICE AND DISCLAIMER

TI PROVIDES TECHNICAL AND RELIABILITY DATA (INCLUDING DATASHEETS), DESIGN RESOURCES (INCLUDING REFERENCE DESIGNS), APPLICATION OR OTHER DESIGN ADVICE, WEB TOOLS, SAFETY INFORMATION, AND OTHER RESOURCES "AS IS" AND WITH ALL FAULTS, AND DISCLAIMS ALL WARRANTIES, EXPRESS AND IMPLIED, INCLUDING WITHOUT LIMITATION ANY IMPLIED WARRANTIES OF MERCHANTABILITY, FITNESS FOR A PARTICULAR PURPOSE OR NON-INFRINGEMENT OF THIRD PARTY INTELLECTUAL PROPERTY RIGHTS.

These resources are intended for skilled developers designing with TI products. You are solely responsible for (1) selecting the appropriate TI products for your application, (2) designing, validating and testing your application, and (3) ensuring your application meets applicable standards, and any other safety, security, regulatory or other requirements.

These resources are subject to change without notice. TI grants you permission to use these resources only for development of an application that uses the TI products described in the resource. Other reproduction and display of these resources is prohibited. No license is granted to any other TI intellectual property right or to any third party intellectual property right. TI disclaims responsibility for, and you fully indemnify TI and its representatives against any claims, damages, costs, losses, and liabilities arising out of your use of these resources.

TI's products are provided subject to [TI's Terms of Sale](#), [TI's General Quality Guidelines](#), or other applicable terms available either on [ti.com](http://ti.com) or provided in conjunction with such TI products. TI's provision of these resources does not expand or otherwise alter TI's applicable warranties or warranty disclaimers for TI products. Unless TI explicitly designates a product as custom or customer-specified, TI products are standard, catalog, general purpose devices.

TI objects to and rejects any additional or different terms you may propose.

Copyright © 2026, Texas Instruments Incorporated

Last updated 10/2025