

TPUL2G223 Dual RC-Timed Non-Retriggerable Monostable Multivibrators

1 Features

- RC configurable from 1µs to 860ms
- For pulses longer than 860ms, use [TPUL2T323](#)
- 1% typical, 10% maximum pulse width variation
- Wide operating range from 1.5V to 5.5V
- Inputs accept voltages up to 5.5V
- Schmitt-trigger architecture on all inputs

2 Applications

- Reset a system for a fixed period of time
- Generate a positive fixed-width digital pulse
- Detect a digital signal rising edge
- Detect a digital signal falling edge
- Debounce a switch

3 Description

The TPUL2G223 device contains two independent RC configurable non-retriggerable monostable multivibrators designed for operation from 1.5V to 5.5V. The output pulse duration is configured by selecting external resistance and capacitance values with an approximate output pulse width of $t_{wo} \cong R \times C$.

This device features three trigger inputs, allowing for rising edge (\overline{T} , \overline{CLR}) or falling edge (\overline{T}) triggers and a clear input (\overline{CLR}) that can be used asynchronously to stop an active output pulse. All trigger inputs include Schmitt-trigger architecture to allow for slow input transition rates and improve noise immunity.

Package Information

PART NUMBER	PACKAGE ⁽¹⁾	PACKAGE SIZE ⁽²⁾	BODY SIZE
TPUL2G223	BQB (WQFN, 16)	3.5mm × 2.5mm	3.5mm × 2.5mm
TPUL2G223	D (SOIC, 16)	9.9mm × 6mm	9.9mm × 3.9mm
TPUL2G223	PW (TSSOP, 16)	5mm × 6.4mm	5mm × 4.4mm

- (1) For all available packages, see the orderable addendum at the end of the data sheet.
 (2) The package size (length × width) is a nominal value and includes pins, where applicable.

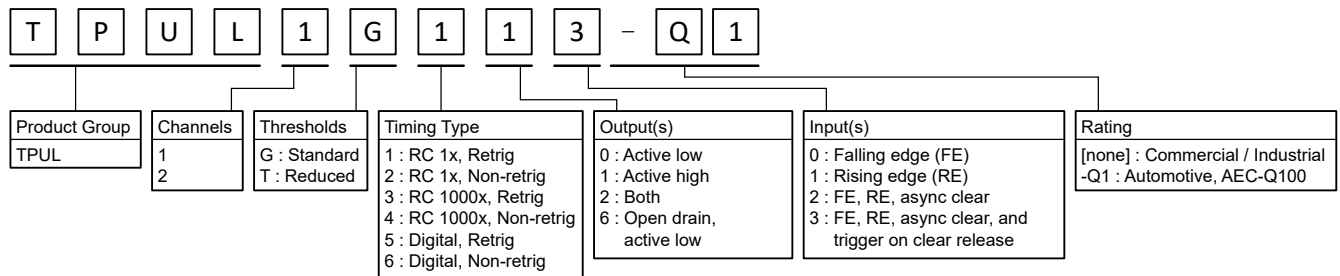

TPUL Family Naming Convention



Table of Contents

1 Features	1	7.4 Device Functional Modes.....	25
2 Applications	1	8 Application and Implementation	26
3 Description	1	8.1 Application Information.....	26
4 Pin Configuration and Functions	3	8.2 Typical Application - Edge Detector.....	26
5 Specifications	4	8.3 Typical Application - Delayed Pulse Generator.....	30
5.1 Absolute Maximum Ratings.....	4	8.4 Power Supply Recommendations.....	30
5.2 ESD Ratings.....	4	8.5 Layout.....	31
5.3 Recommended Operating Conditions.....	4	9 Device and Documentation Support	32
5.4 Thermal Information.....	5	9.1 Documentation Support.....	32
5.5 Electrical Characteristics.....	5	9.2 Receiving Notification of Documentation Updates....	32
5.6 Timing Characteristics.....	7	9.3 Support Resources.....	32
5.7 Switching Characteristics.....	8	9.4 Trademarks.....	32
5.8 Typical Characteristics.....	10	9.5 Electrostatic Discharge Caution.....	32
6 Parameter Measurement Information	17	9.6 Glossary.....	32
7 Detailed Description	19	10 Revision History	32
7.1 Overview.....	19	11 Mechanical, Packaging, and Orderable Information	32
7.2 Functional Block Diagram.....	20		
7.3 Feature Description.....	21		

4 Pin Configuration and Functions

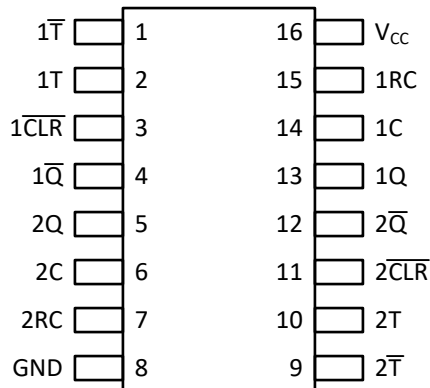

See mechanical drawings for dimensions.

Figure 4-1. D and PW Package 16-Pin SOIC and TSSOP Top View

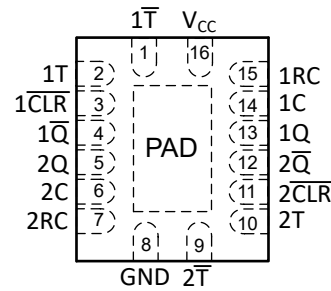

See mechanical drawings for dimensions.

Figure 4-2. BQB Package 16-Pin WQFN Transparent Top View

Table 4-1. Pin Functions

PIN		TYPE ⁽¹⁾	DESCRIPTION
NAME	NO.		
1C	14	G	Channel 1 external timing capacitor negative connection; provides a return path for discharge current of the external timing capacitor; internally connected to ground
1CLR	3	I	Channel 1 asynchronous clear input, active low; also can operate as rising edge trigger input if 1T-bar is held low and 1T is held high
1Q-bar	4	O	Channel 1 inverted output
1Q	13	O	Channel 1 output
1RC	15	I/O	Channel 1 external timing node connection; see <i>Application Information</i> section for detailed operation instructions
1T-bar	1	I	Channel 1 falling edge trigger input; requires 1T and 1CLR-bar to be held high
1T	2	I	Channel 1 rising edge trigger input; requires 1T-bar to be held low and 1CLR-bar to be held high
2C	6	G	Channel 2 external timing capacitor negative connection; provides a return path for discharge current of the external timing capacitor; internally connected to ground
2CLR-bar	11	I	Channel 2 asynchronous clear input, active low; also can operate as rising edge trigger input if 2T-bar is held low and 2T is held high
2Q	5	O	Channel 2 output
2Q-bar	12	O	Channel 2 inverted output
2RC	7	I/O	Channel 2 external timing node connection; see <i>Application Information</i> section for detailed operation instructions
2T-bar	9	I	Channel 2 falling edge trigger input; requires 2T and 2CLR-bar to be held high
2T	10	I	Channel 2 rising edge trigger input; requires 2T-bar to be held low and 2CLR-bar to be held high
GND	8	G	Ground
Thermal pad ⁽²⁾	—	—	The thermal pad can be connect to GND or left floating. Do not connect to any other signal or supply.
V _{CC}	16	P	Positive voltage supply

(1) I = Input, O = Output, I/O = Input and output, G = Ground, P = Power

(2) BQB package only

5 Specifications

5.1 Absolute Maximum Ratings

over operating free-air temperature range (unless otherwise noted)⁽¹⁾

			MIN	MAX	UNIT
V _{CC}	Supply voltage range		-0.5	6.5	V
V _I	Digital input voltage range ⁽²⁾		-0.5	6.5	V
V _O	Digital output voltage range in the active state ⁽²⁾		-0.5	V _{CC} + 0.5	V
V _O	Digital output voltage range in the high-impedance state ⁽²⁾		-0.5	6.5	V
V _{RC}	RC pin voltage range		-0.5	V _{CC} + 0.5	V
I _{IK}	Input clamp diode current, continuous	V _I < -0.5V		-20	mA
	Input clamp diode current, pulsed 1μs	V _I < -0.5V		-200	mA
I _{OK}	Output clamp diode current, continuous	V _O < -0.5V		-20	mA
	Output clamp diode current, pulsed 1μs	V _O < -0.5V		-200	mA
I _O	Digital output current, continuous	V _O = 0 to V _{CC}		±50	mA
	Digital output current, pulsed 1μs	V _O = 0 to V _{CC}		±200	mA
	Continuous current through V _{CC} or GND			±200	mA
R _{ext}	External timing resistance		1		kΩ
C _{ext}	External timing capacitance			1 ⁽³⁾	μF
T _J	Junction temperature			150	°C
T _{stg}	Storage temperature		-65	150	°C

(1) Operation outside the *Absolute Maximum Ratings* may cause permanent device damage. Absolute maximum ratings do not imply functional operation of the device at these or any other conditions beyond those listed under *Recommended Operating Conditions*. If briefly operating outside the *Recommended Operating Conditions* but within the *Absolute Maximum Ratings*, the device may not sustain damage, but it may not be fully functional. Operating the device in this manner may affect device reliability, functionality, performance, and shorten the device lifetime.

(2) The voltage ratings may be exceeded if the associated clamp current ratings are observed.

(3) The timing capacitance maximum value may be exceeded if an external diode is added. See *Application and Implementation* section for details.

5.2 ESD Ratings

			VALUE	UNIT
V _(ESD)	Electrostatic discharge	Human-body model (HBM), per ANSI/ESDA/JEDEC JS-001 ⁽¹⁾	±2000	V
		Charged-device model (CDM), per ANSI/ESDA/JEDEC JS-002 ⁽²⁾	±1000	

(1) JEDEC document JEP155 states that 500V HBM allows safe manufacturing with a standard ESD control process.

(2) JEDEC document JEP157 states that 250V CDM allows safe manufacturing with a standard ESD control process.

5.3 Recommended Operating Conditions

over operating free-air temperature range (unless otherwise noted)

Spec	Description	Condition	MIN	MAX	UNIT
V _{CC}	Supply voltage		1.5	5.5	V
V _I ⁽¹⁾	Input Voltage		0	5.5	V
V _O	Output Voltage		0	V _{CC}	V
I _{OH} ⁽²⁾	High-level output current	V _{CC} = 1.5V		-4	mA
		V _{CC} = 1.8V		-6	mA
		V _{CC} = 2.5V		-26	mA
		V _{CC} = 3.3V		-50	mA
		V _{CC} = 5V		-50	mA

over operating free-air temperature range (unless otherwise noted)

Spec	Description	Condition	MIN	MAX	UNIT
I _{OL} ⁽²⁾	Low-level output current	V _{CC} = 1.5V		4	mA
		V _{CC} = 1.8V		6	mA
		V _{CC} = 2.5V		26	mA
		V _{CC} = 3.3V		50	mA
		V _{CC} = 5V		50	mA
R _{ext} ⁽³⁾	External timing resistance	V _{CC} = 1.5V to 5.5V	6.5	1000	kΩ
C _{ext} ⁽³⁾	External timing capacitance	V _{CC} = 1.5V to 5.5V	0.1	1000	nF
t _{wo}	Configured output pulse width	V _{CC} = 1.5V to 5.5V	0.001	860	ms
C _L	Digital output load capacitance	V _{CC} = 1.5V to 5.5V		50	pF
V _{POR}	Power-on reset ramp voltage	Δt/ΔV _{CC} ≥ 20μs/V	0.3	1.5	V
Δt/ΔV _{CC}	Power-on ramp rate	V _{CC} = 0.3V to 1.5V	20		μs/V
Δt/Δv	Input transition rise or fall rate	V _{CC} = 1.5V to 5.5V		100	ms/V
T _A	Operating free-air temperature	Operating free-air temperature	-40	125	°C

- (1) All unused inputs of the device must be held at V_{CC} or GND to ensure proper device operation.
- (2) Recommended maximum output current for continuous operation; see *Electrical Characteristics* for test current values to maintain V_{OH} and V_{OL} specifications. Operating with average output current greater than 12mA may impact device reliability and shorten the device lifetime.
- (3) Recommended R_{ext} and C_{ext} values maintain maximum error provided as Δt_{wo} in the *Switching Characteristics* table.

5.4 Thermal Information

PACKAGE	PINS	THERMAL METRIC ⁽¹⁾						UNIT
		R _{θJA}	R _{θJC(top)}	R _{θJB}	Ψ _{JT}	Ψ _{JB}	R _{θJC(bot)}	
PW (TSSOP)	16	138.3	75.1	96.5	19.4	95.5	N/A	°C/W
D (SOIC)	16	112.3	73.9	75.1	32.2	74.3	N/A	°C/W
BQB (WQFN)	16	86.3	90.6	56.4	15.2	56.3	32.9	°C/W

- (1) For more information about traditional and new thermal metrics, see the [Semiconductor and IC Package Thermal Metrics](#) application note.

5.5 Electrical Characteristics

Over operating free-air temperature range; typical values measured at T_A = 25°C (unless otherwise noted)

PARAMETER		TEST CONDITIONS	V _{CC}	MIN	TYP	MAX	UNIT
V _{T+}	Positive switching threshold		1.5V	0.75	0.90	0.99	V
			1.8V	0.86	1.03	1.17	
			2.5V	1.1	1.29	1.47	
			3.3V	1.37	1.56	1.76	
			5V	1.92	2.16	2.4	
			5.5V	2.08	2.33	2.6	
V _{T-}	Negative switching threshold		1.5V	0.41	0.47	0.54	V
			1.8V	0.48	0.53	0.6	
			2.5V	0.63	0.69	0.76	
			3.3V	0.8	0.87	0.96	
			5V	1.13	1.25	1.39	
			5.5V	1.22	1.36	1.51	

Over operating free-air temperature range; typical values measured at $T_A = 25^\circ\text{C}$ (unless otherwise noted)

PARAMETER		TEST CONDITIONS	V _{CC}	MIN	TYP	MAX	UNIT
ΔV_T	Hysteresis ($V_{T+} - V_{T-}$)		1.5V	0.34	0.45	0.6	V
			1.8V	0.38	0.5	0.66	
			2.5V	0.47	0.6	0.78	
			3.3V	0.56	0.69	0.89	
			5V	0.77	0.9	1.12	
			5.5V	0.83	0.96	1.2	
V_{OH}	High-level output voltage	$I_{OH} = -50\mu\text{A}$	1.5V - 5.5V	$V_{CC} - 0.1$	$V_{CC} - 0.01$		V
		$I_{OH} = -1\text{mA}$	1.65V	1.2	1.61		
		$I_{OH} = -2\text{mA}$	2.3V	2.1	2.24		
		$I_{OH} = -8\text{mA}$	3V	2.4	2.78		
		$I_{OH} = -12\text{mA}$	4.5V	3.94	4.21		
		$I_{OH} = -12\text{mA}$	5.5V	4.94	5.23		V
V_{OL}	Low-level output voltage	$I_{OL} = 50\mu\text{A}$	1.5V - 5.5V		0.01	0.1	V
		$I_{OL} = 1\text{mA}$	1.65V		0.03	0.45	
		$I_{OL} = 2\text{mA}$	2.3V		0.04	0.2	
		$I_{OL} = 8\text{mA}$	3V		0.13	0.4	
		$I_{OL} = 12\text{mA}$	4.5V		0.15	0.5	
		$I_{OL} = 12\text{mA}$	5.5V		0.13	0.5	
I_I	Input leakage current	$V_I = 5.5\text{V}$ or 0V	0V to 5.5V			± 50	nA
I_{CEXT}	Capacitor pin current	Monitor state, $V_{CEXT} = 0.5 \times V_{CC}$	1.5V to 5.5V			± 50	nA
I_{CEXT}	Capacitor pin current	Active state, discharging, $V_{CEXT} = 1.5\text{V}$	1.5V			11	mA
		Active state, discharging, $V_{CEXT} = 2.3\text{V}$	2.3V			29	mA
		Active state, discharging, $V_{CEXT} = 3\text{V}$	3V			45	mA
		Active state, discharging, $V_{CEXT} = 4.5\text{V}$	4.5V			95	mA
		Active state, discharging, $V_{CEXT} = 5.5\text{V}$	5.5V			138	mA
I_{off}	Partial power-off current	V_I or $V_O = 5.5\text{V}$ or 0V	0V to 0.3V		0.25	10	μA
I_{CC}	Supply current	Ready state, $V_I = V_{CC}$ or 0V , $I_O = 0$	5.5V		0.19	2	μA
I_{CC}	Supply current	Active state per channel, $V_I = V_{CC}$ or 0V , $I_O = 0$	1.5V			40	μA
			1.65V			50	
			2.3V			75	
			3V			100	
			4.5V			155	
			5.5V			195	
ΔI_{CC}	Supply-current change	One input, $V_I = 0$ to V_{CC} , all other inputs at V_{CC} or 0V , $I_O = 0\text{mA}$	1.5V to 5.5V			1.5	mA
C_I	Input capacitance	$V_I = 5.5\text{V}$ or 0V	5.5V		1.3		pF
C_O	Output capacitance	$V_O = 5.5\text{V}$ or 0V	0V		3.1		pF

Over operating free-air temperature range; typical values measured at $T_A = 25^\circ\text{C}$ (unless otherwise noted)

PARAMETER		TEST CONDITIONS	V_{CC}	MIN	TYP	MAX	UNIT
C_{int}	Internal capacitance	$C_{ext} = 0\text{pF}; V_{cext} = 0 \text{ to } V_{CC}$	1.5V	16	17.9	20	pF
			1.65V	14	15.5	17	
			2.3V	7	9.7	13	
			3V	6	9.9	14	
			4.5V	5	7.7	10	
			5.5V	4	5.7	7	

5.6 Timing Characteristics

over recommended operating free-air temperature range (unless otherwise noted)

PARAMETER	DESCRIPTION	CONDITION	V_{CC}	MIN	MAX	UNIT
t_{wi}	Pulse duration	Any trigger input	1.5V	18.2		ns
			$1.8\text{V} \pm 0.15\text{V}$	9.9		
			$2.5\text{V} \pm 0.2\text{V}$	7.8		
			$3.3\text{V} \pm 0.3\text{V}$	5.8		
			$5\text{V} \pm 0.5\text{V}$	4.1		
t_{su}	Setup time between trigger inputs	\bar{T} low before $T\uparrow$ or $\overline{CLR}\uparrow$	1.5V	9.6		ns
			$1.8\text{V} \pm 0.15\text{V}$	8		
			$2.5\text{V} \pm 0.2\text{V}$	6.9		
			$3.3\text{V} \pm 0.3\text{V}$	6.6		
			$5\text{V} \pm 0.5\text{V}$	6.5		
		T high before $\bar{T}\downarrow$ or $\overline{CLR}\uparrow$	1.5V	5		ns
			$1.8\text{V} \pm 0.15\text{V}$	5		
			$2.5\text{V} \pm 0.2\text{V}$	5		
			$3.3\text{V} \pm 0.3\text{V}$	5		
			$5\text{V} \pm 0.5\text{V}$	5		
\overline{CLR} high before $\bar{T}\downarrow$ or $T\uparrow$	1.5V	9.2		ns		
	$1.8\text{V} \pm 0.15\text{V}$	7.8				
	$2.5\text{V} \pm 0.2\text{V}$	6.7				
	$3.3\text{V} \pm 0.3\text{V}$	6.5				
	$5\text{V} \pm 0.5\text{V}$	6.4				
t_h	Hold time	Any trigger input	1.5V	9.3		ns
			$1.8\text{V} \pm 0.15\text{V}$	7.8		
			$2.5\text{V} \pm 0.2\text{V}$	6.7		
			$3.3\text{V} \pm 0.3\text{V}$	6.5		
			$5\text{V} \pm 0.5\text{V}$	6.4		
$t_{startup}^{(1)}$	Startup time		1.5V to 5.5V		0	μs

- (1) Triggers received during device startup may be ignored. The external timing capacitor requires time to charge after startup. For optimal first pulse accuracy, wait a minimum of $500 \times C_{ext}$ seconds after supply voltage has reached stable operating conditions before applying the first trigger.

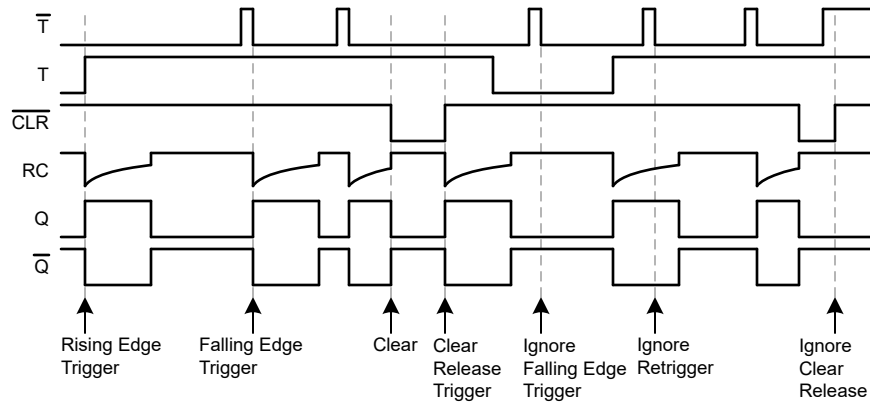

Figure 5-1. Input/Output Timing Diagram

5.7 Switching Characteristics

over operating free-air temperature range; typical values measured at $T_A = 25^\circ\text{C}$ (unless otherwise noted). See *Parameter Measurement Information*.

PARAMETER	FROM (INPUT)	TO (OUTPUT)	TEST CONDITIONS	V_{CC}	MIN	TYP	MAX	UNIT
$C_L = 15\text{pF}$								
t_{pd}	\bar{T} , T, or \bar{CLR}	Q or \bar{Q}	$C_L = 15\text{pF}$	1.5V	13	28.6	64	ns
				1.65V	10.9	23.1	50.9	ns
				2.3V	6.6	13.7	27.4	ns
				3V	5.1	9.8	19.7	ns
				4.5V	3.8	7.1	13.5	ns
				5.5V	3.4	6.3	11.7	ns
t_t		Q or \bar{Q}	$C_L = 15\text{pF}$	1.5V		3	6.9	ns
				1.65V		2.6	5.7	ns
				2.3V		1.9	3.6	ns
				3V		1.6	2.9	ns
				4.5V		1.3	2.4	ns
				5.5V		1.1	2.1	ns
$C_L = 50\text{pF}$								
t_{pd}	\bar{T} , T, or \bar{CLR}	Q or \bar{Q}	$C_L = 50\text{pF}$	1.5V	13	31.8	71.2	ns
				1.65V	10.9	24.8	56.7	ns
				2.3V	6.6	14.3	31.1	ns
				3V	5.1	10.8	22.5	ns
				4.5V	3.8	7.9	15.8	ns
				5.5V	3.4	7	13.9	ns
$t_{wo}^{(1)}$		Q or \bar{Q}	$R_{ext} = 10\text{k}\Omega$; $C_{ext} = 0$; $C_L = 50\text{pF}$	1.5V			405	ns
				1.65V			311	ns
				2.3V		87	161	ns
				3V		75	118	ns
				4.5V		62	96	ns
				5.5V		58	88	ns

over operating free-air temperature range; typical values measured at $T_A = 25^\circ\text{C}$ (unless otherwise noted). See *Parameter Measurement Information*.

PARAMETER	FROM (INPUT)	TO (OUTPUT)	TEST CONDITIONS	V_{CC}	MIN	TYP	MAX	UNIT
t_{wo} (1)		Q or \bar{Q}	$R_{ext} = 10\text{k}\Omega$; $C_{ext} = 0.1\mu\text{F}$; $C_L = 50\text{pF}$	1.5V	814		996	μs
				1.65V	815		997	μs
				2.3V	815		997	μs
				3V	815		997	μs
				4.5V	805		985	μs
				5.5V	793		971	μs
Δt_{wo} (2)		Q or \bar{Q}	$C_L = 50\text{pF}$	1.5V		± 1	± 10	%
t_t		Q or \bar{Q}	$C_L = 50\text{pF}$	1.5V		3.8	28.6	ns
				1.65V		3.4	23.3	ns
				2.3V		2.6	20.5	ns
				3V		2.1	14.5	ns
				4.5V		1.7	10.5	ns
				5.5V		1.5	7.2	ns
C_{pd}	$\overline{\text{CLR}}$		$T = V_{CC}$, $\bar{T} = \text{GND}$ $f_i = 10\text{MHz}$ $C_L = 50\text{pF}$ $C_{ext} = 0\text{pF}$ $R_{ext} = 1\text{M}\Omega$	1.5V		40		pF
				1.65V		40		pF
				2.3V		40		pF
				3V		40		pF
				4.5V		40		pF
				5.5V		40		pF

(1) Output pulse width

(2) Variation in output pulse width as compared to typical characteristics for K factor excluding external timing components.

5.8 Typical Characteristics

T_A = 25°C (unless otherwise noted)

Table 5-1. Pulse Width Using Common RC, V_{CC} = 3.3V

Resistor Value	Capacitor Value						
	10μF	1μF	100nF	10nF	1nF	100pF	10pF
1kΩ	9.89ms	989μs	103μs	10.7μs	1.19μs	175ns	60ns
1.5kΩ	14.7ms	1.47ms	1.50μs	15.5μs	1.7μs	236ns	68ns
2.2kΩ	21.2ms	2.12ms	215μs	21.2μs	2.43μs	323ns	83ns
3.3kΩ	31.3ms	3.13ms	318μs	32.8μs	3.56μs	457ns	100ns
4.7kΩ	44.2ms	4.42ms	442μs	46.1μs	5.02μs	628ns	122ns
6.8kΩ	63.6ms	6.37ms	645μs	66.5μs	7.19μs	883ns	153ns
10kΩ	92.9ms	9.29ms	943μs	97.1μs	10.5μs	1.27μs	202ns
15kΩ	139ms	13.9ms	1.40ms	146μs	15.7μs	1.87μs	275ns
22kΩ	204ms	20.4ms	2.07ms	213μs	22.9μs	2.73μs	378ns
33kΩ	306ms	30.6ms	3.09ms	319μs	34.4μs	4.05μs	539ns
47kΩ	434ms	43.4ms	4.40ms	453μs	48.7μs	5.74μs	745ns
68kΩ	629ms	62.9ms	6.37ms	654μs	70.6μs	8.27μs	1.04μs
100kΩ	924ms	92.4ms	9.36ms	962μs	104μs	12.2μs	1.52μs
150kΩ	1.38s	138ms	14.0ms	1.45ms	156μs	18.1μs	2.24μs
220kΩ	2.03s	203ms	20.5ms	2.12ms	229μs	26.6μs	3.25μs
330kΩ	3.05s	305ms	30.8ms	3.17ms	343μs	39.6μs	4.83μs
470kΩ	4.34s	434ms	43.8ms	4.53ms	489μs	56.7μs	6.85μs
680kΩ	6.28s	628ms	63.4ms	6.53ms	707μs	82.4μs	9.88μs
1MΩ	9.18s	918ms	93.5ms	9.65ms	1.04ms	121μs	14.5μs

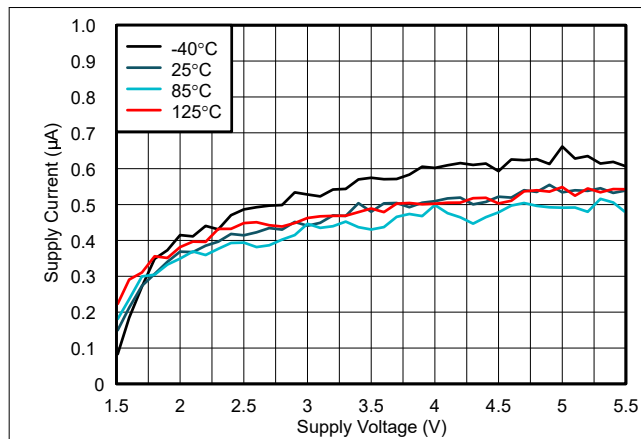

Figure 5-2. Supply Current vs Supply Voltage

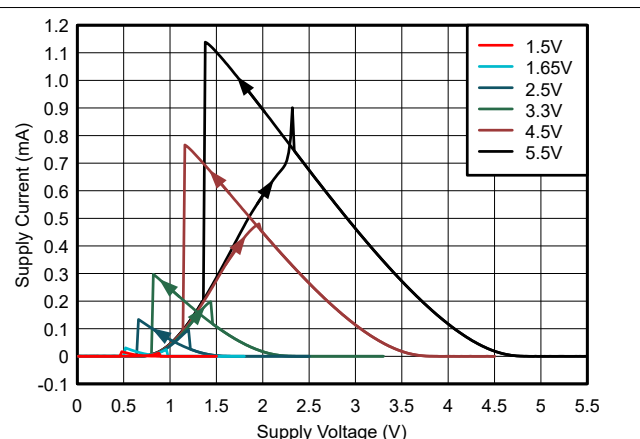

Figure 5-3. Supply Current vs Input Voltage

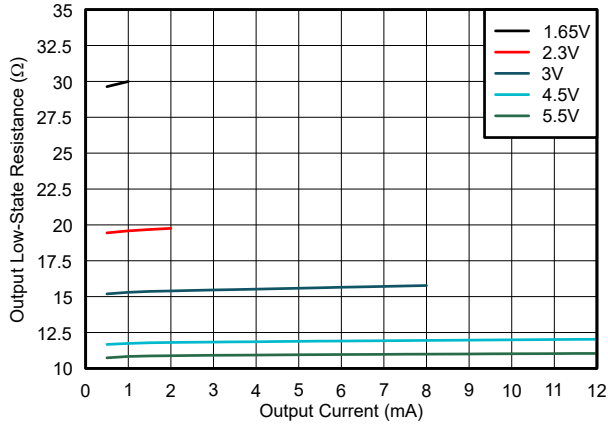

Figure 5-4. Output Low-State Resistance vs Output Current

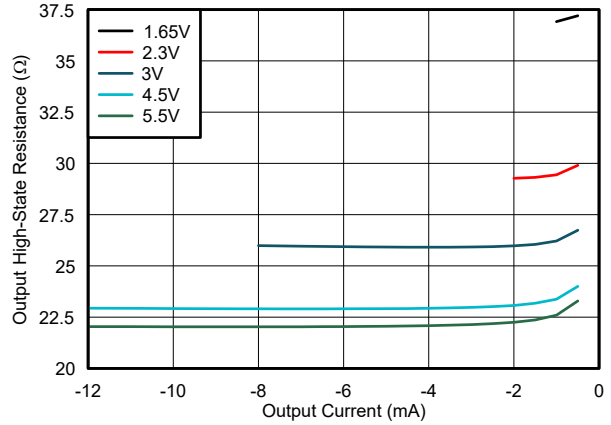

Figure 5-5. Output High-State Resistance vs Output Current

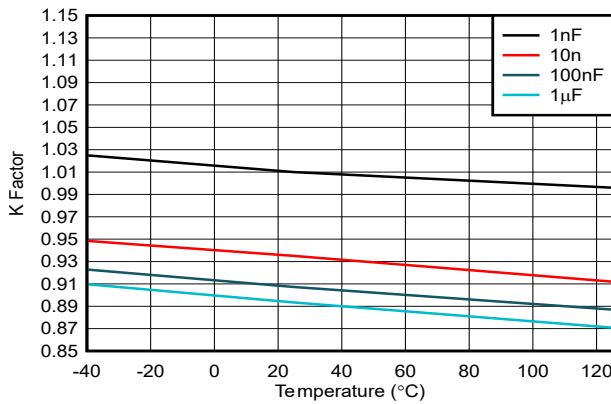

Figure 5-6. K Factor vs Temperature, $R_{ext} = 10k\Omega$

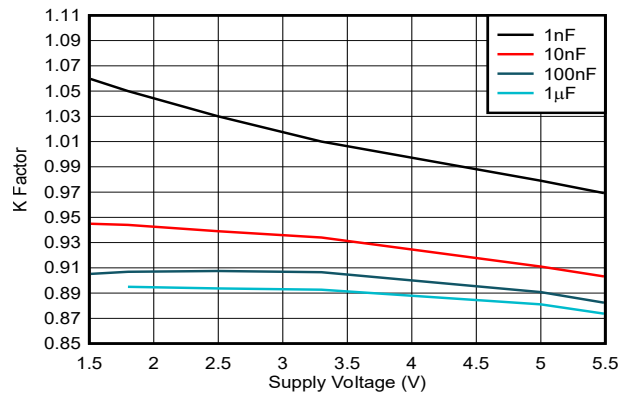

Figure 5-7. K Factor vs Supply Voltage, $R_{ext} = 10k\Omega$

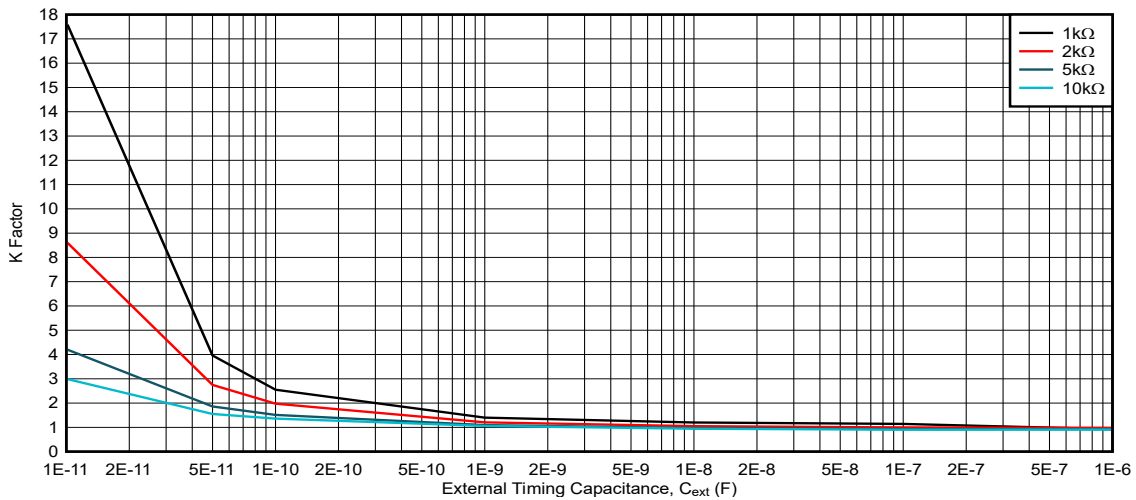

Figure 5-8. K Factor, $V_{CC} = 1.5V$, $R_{ext} = 1k\Omega$ to $10k\Omega$

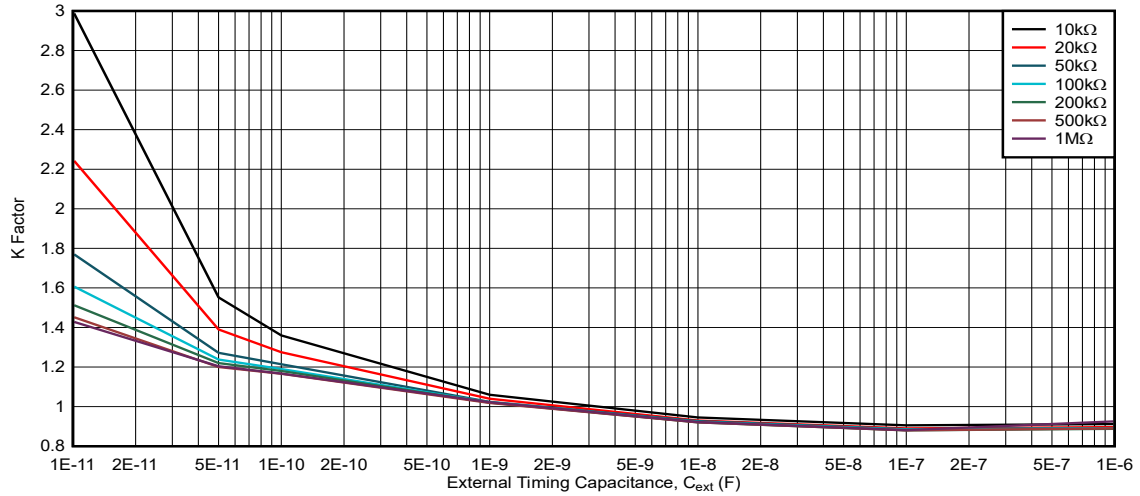

Figure 5-9. K Factor, $V_{CC} = 1.5V$, $R_{ext} = 10k\Omega$ to $1M\Omega$

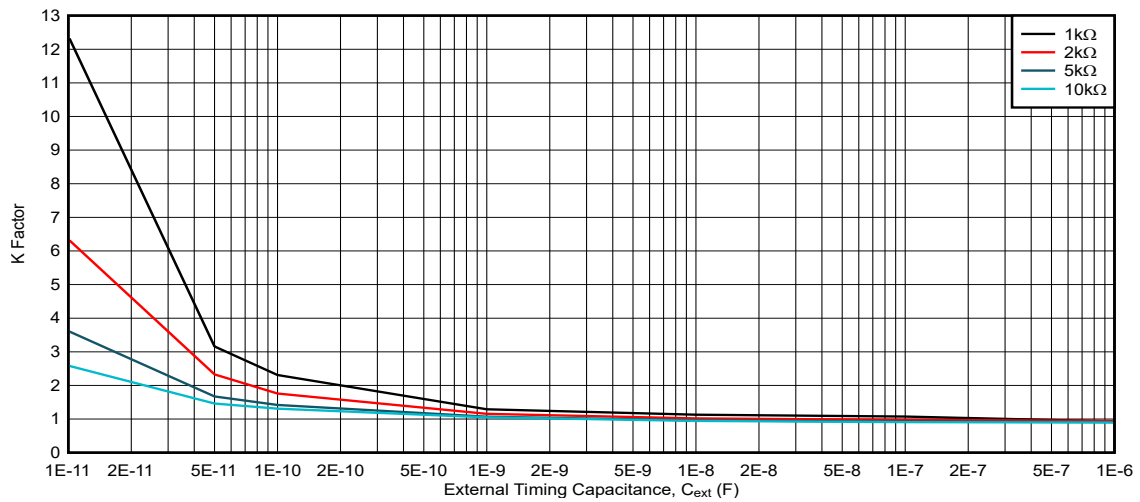

Figure 5-10. K Factor, $V_{CC} = 1.8V$, $R_{ext} = 1k\Omega$ to $10k\Omega$

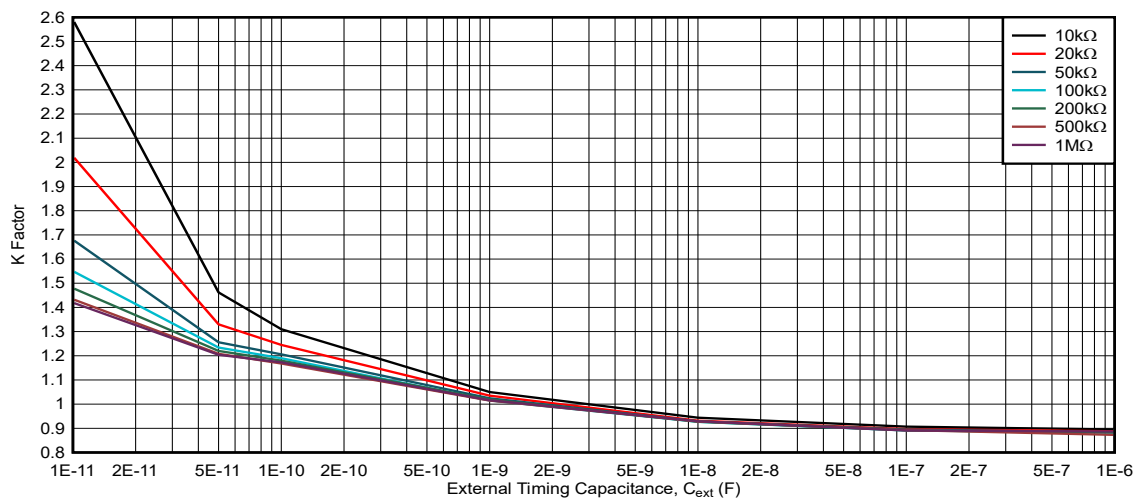

Figure 5-11. K Factor, $V_{CC} = 1.8V$, $R_{ext} = 10k\Omega$ to $1M\Omega$

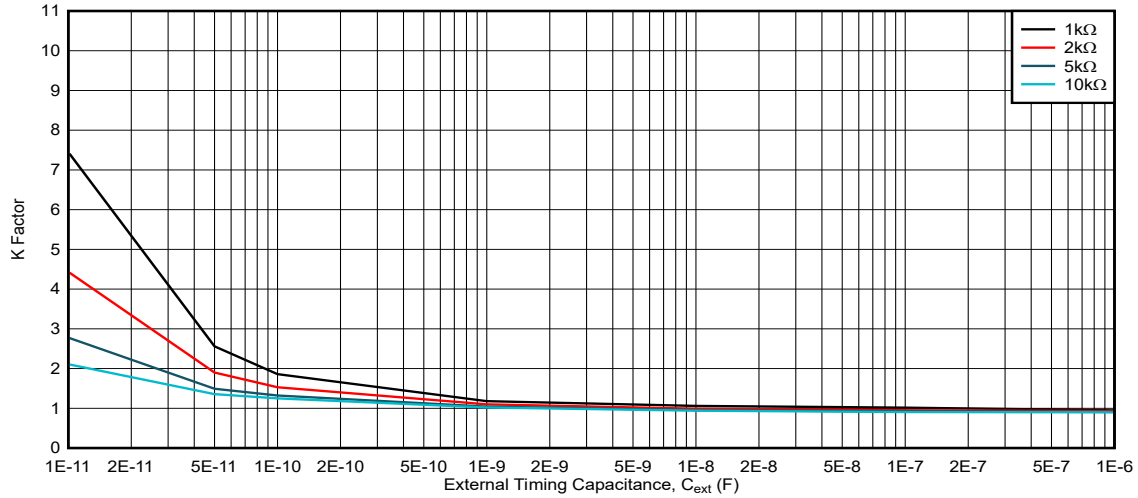

Figure 5-12. K Factor, $V_{CC} = 2.5V$, $R_{ext} = 1k\Omega$ to $10k\Omega$

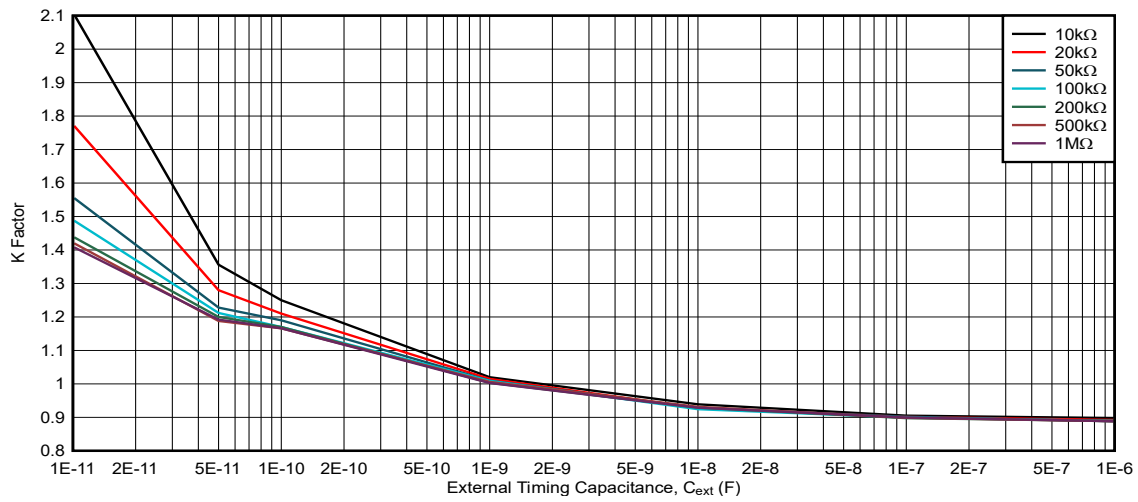

Figure 5-13. K Factor, $V_{CC} = 2.5V$, $R_{ext} = 10k\Omega$ to $1M\Omega$

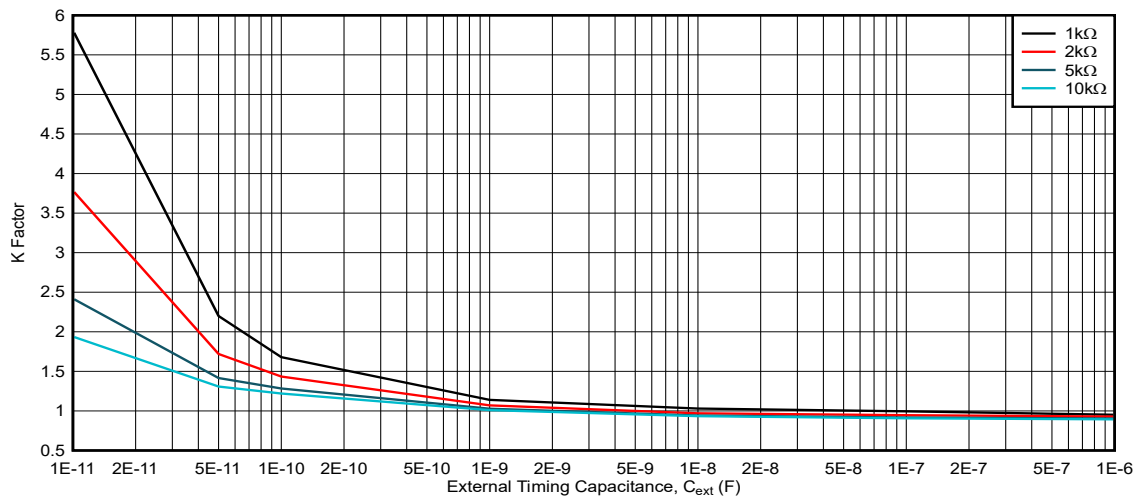

Figure 5-14. K Factor, $V_{CC} = 3.3V$, $R_{ext} = 1k\Omega$ to $10k\Omega$

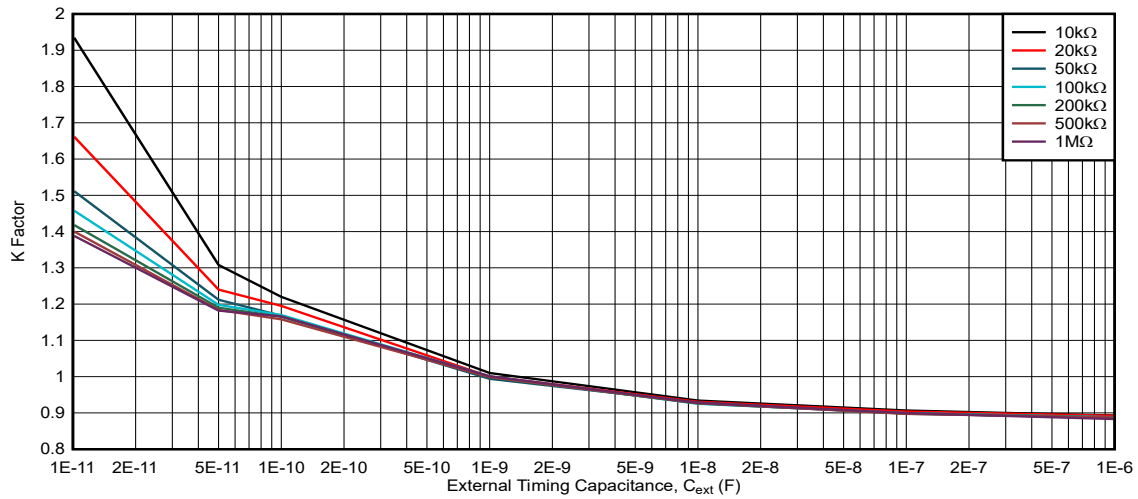

Figure 5-15. K Factor, $V_{CC} = 3.3V$, $R_{ext} = 10k\Omega$ to $1M\Omega$

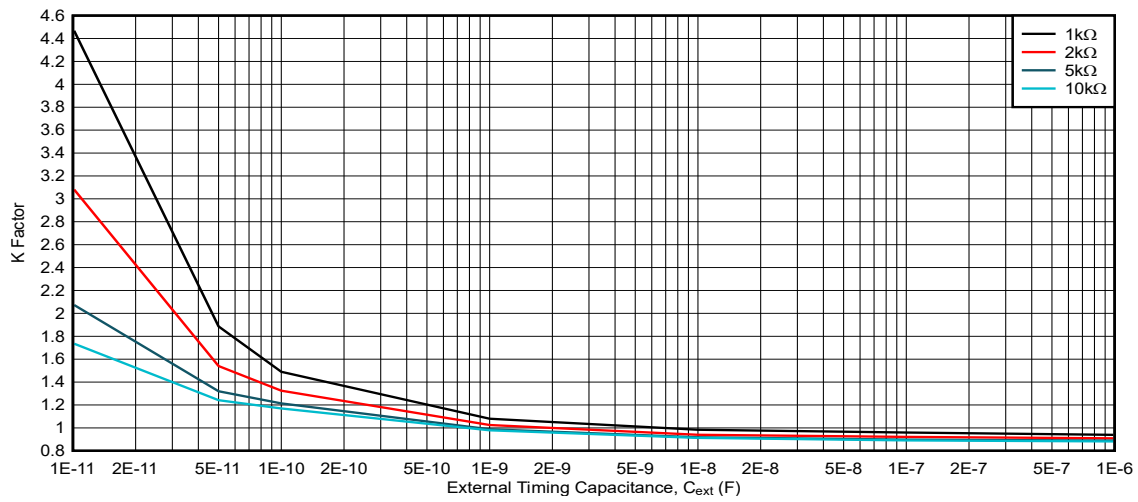

Figure 5-16. K Factor, $V_{CC} = 5V$, $R_{ext} = 1k\Omega$ to $10k\Omega$

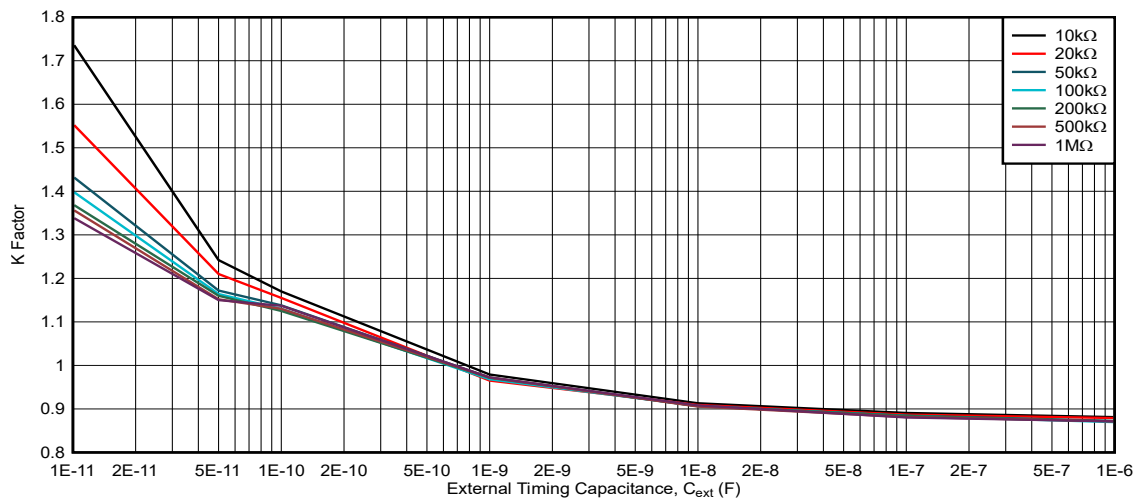

Figure 5-17. K Factor, $V_{CC} = 5V$, $R_{ext} = 10k\Omega$ to $1M\Omega$

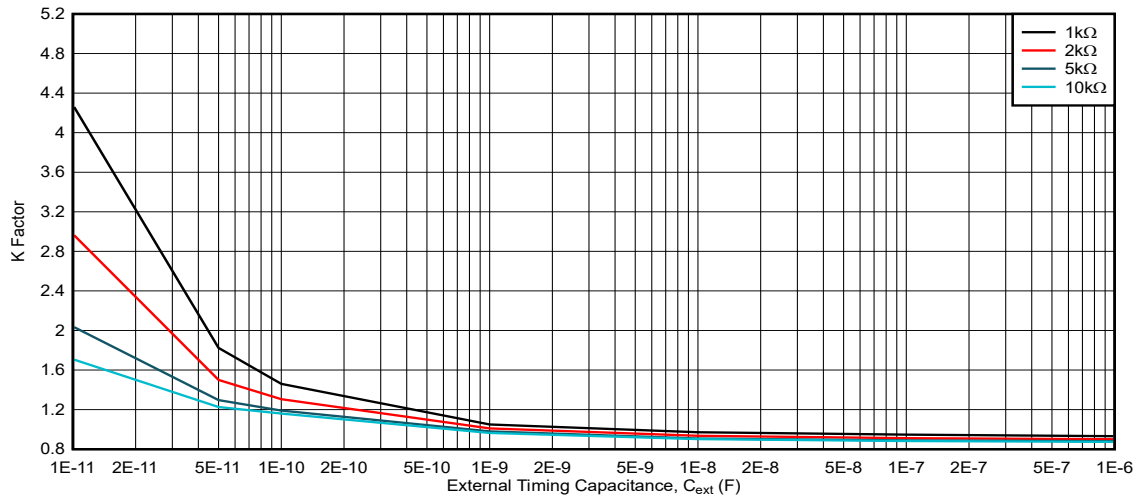

Figure 5-18. K Factor, $V_{CC} = 5.5V$, $R_{ext} = 1k\Omega$ to $10k\Omega$

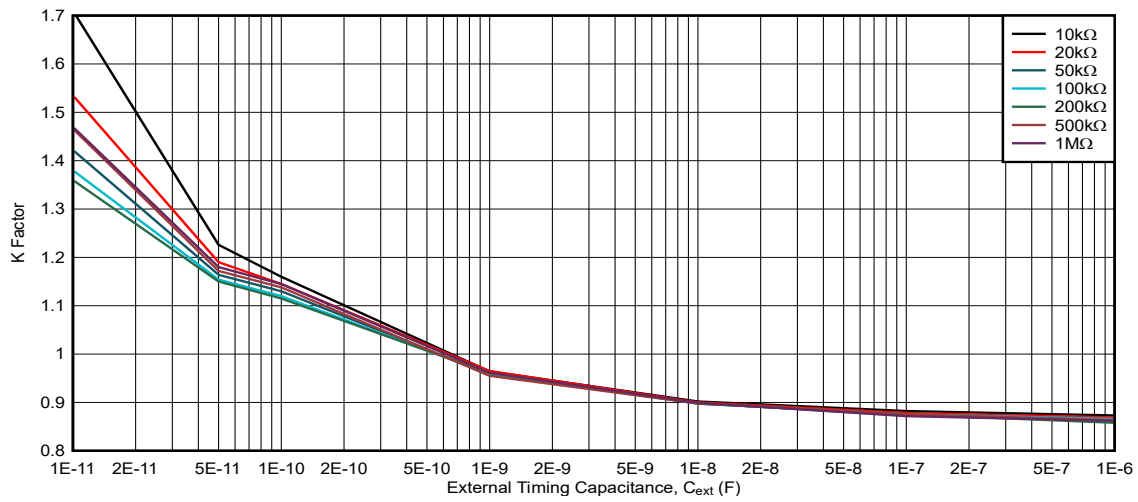

Figure 5-19. K Factor, $V_{CC} = 5.5V$, $R_{ext} = 10k\Omega$ to $1M\Omega$

Error data in the following plots indicates changes from typical behavior (nominal material, $T_A = 25^\circ C$) due to variation in manufacturing process and operating free-air temperature.

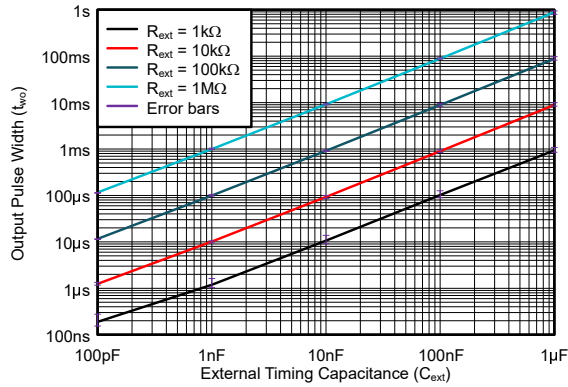

Figure 5-20. Typical Output Pulse Width vs Timing Capacitance Value With Error Bar Overlay

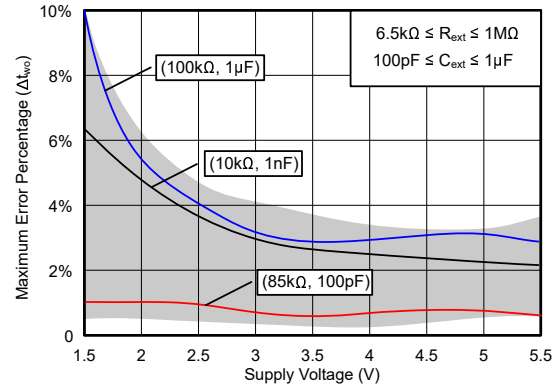

Figure 5-21. Maximum Output Pulse Width Error (Absolute Value) Across Supply Voltage Each Line: One Timing Component Combination Shaded Area: All Timing Component Combinations

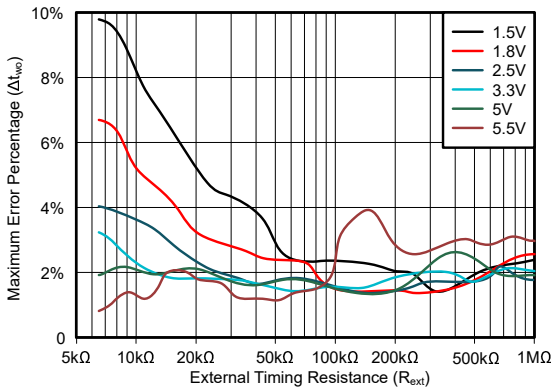

Figure 5-22. Maximum Output Pulse Width Error (Absolute Value) Versus Timing Resistor Values With $C_{ext} = 100\text{pF}$

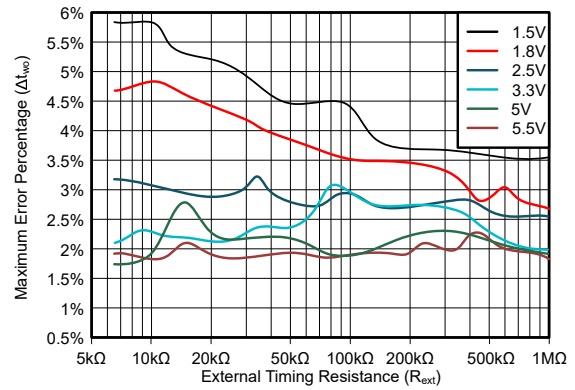
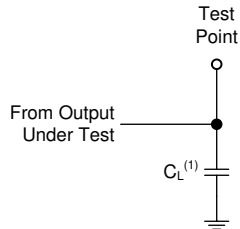

Figure 5-23. Maximum Output Pulse Width Error (Absolute Value) Versus Timing Resistor Values With $C_{ext} = 1\text{nF}$

6 Parameter Measurement Information

Phase relationships between waveforms were chosen arbitrarily for the examples listed in the following table. All input pulses are supplied by generators having the following characteristics: $PRR \leq 1\text{MHz}$, $Z_O = 50\Omega$, $t_t < 2.5\text{ns}$.

The outputs are measured individually with one input transition per measurement.



(1) C_L includes probe and test-fixture capacitance.

Figure 6-1. Load Circuit for Push-Pull Outputs

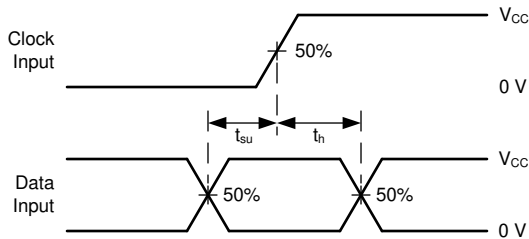
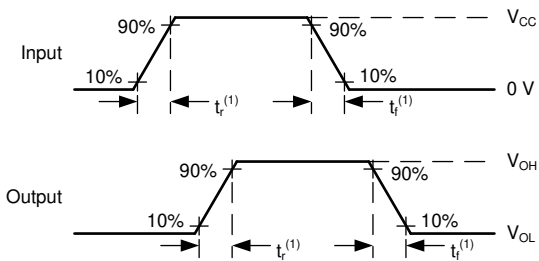

Figure 6-3. Voltage Waveforms, Setup and Hold Times



(1) The greater between t_r and t_f is the same as t_t .

Figure 6-5. Voltage Waveforms, Input and Output Transition Times

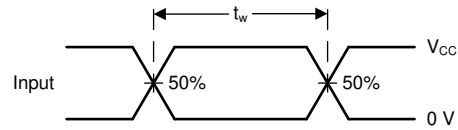
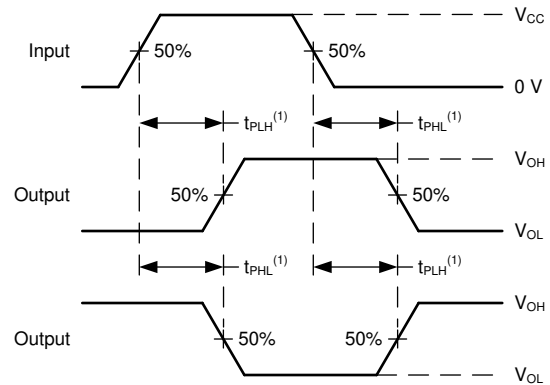

Figure 6-2. Voltage Waveforms, Pulse Duration



(1) The greater between t_{PLH} and t_{PHL} is the same as t_{pd} .

Figure 6-4. Voltage Waveforms Propagation Delays

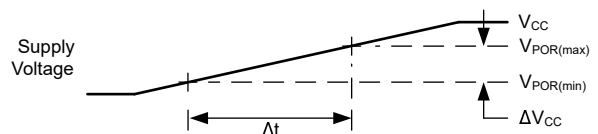

Figure 6-6. Voltage Waveforms, Supply Ramp

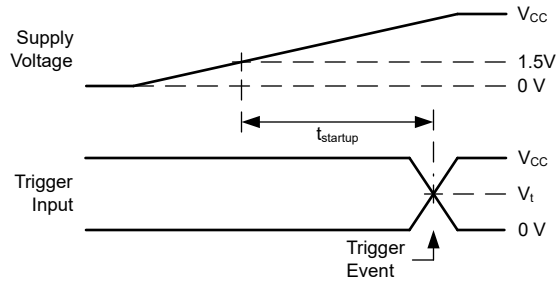

Figure 6-7. Voltage Waveforms, Startup Time

7 Detailed Description

7.1 Overview

The TPUL2G223 device contains two independent non-retriggerable monostable multivibrator circuits. A monostable multivibrator, also commonly known as a "one shot," produces a single digital pulse when triggered and otherwise maintains a constant output state.

The TPUL2G223 device features three gated trigger inputs for each channel. For a rising edge trigger, the T or $\overline{\text{CLR}}$ input is used. For a falling edge trigger the $\overline{\text{T}}$ input is used.

The TPUL2G223 device includes an asynchronous clear input ($\overline{\text{CLR}}$) that can be used to terminate an ongoing output pulse.

When triggered, the TPUL2G223 outputs a positive digital pulse with pulse width defined as $t_{\text{wo}} = K \times R_{\text{ext}} \times C_{\text{ext}}$, with R_{ext} and C_{ext} being the external timing resistor and external timing capacitor component values measured in Ω and F, respectively, and K being a unitless nonlinearity correction factor provided in the *Typical Characteristics* section. The external timing components must be connected as shown in Figure 7-1. The external ground connection to the C terminal is optional.



Figure 7-1. Timing component connection, with and without external ground

7.1.1 State Machine Description

The TPUL2G223 contains a simple state machine as shown in the *State Machine Diagram* with only three states: ready, discharge, monitor.

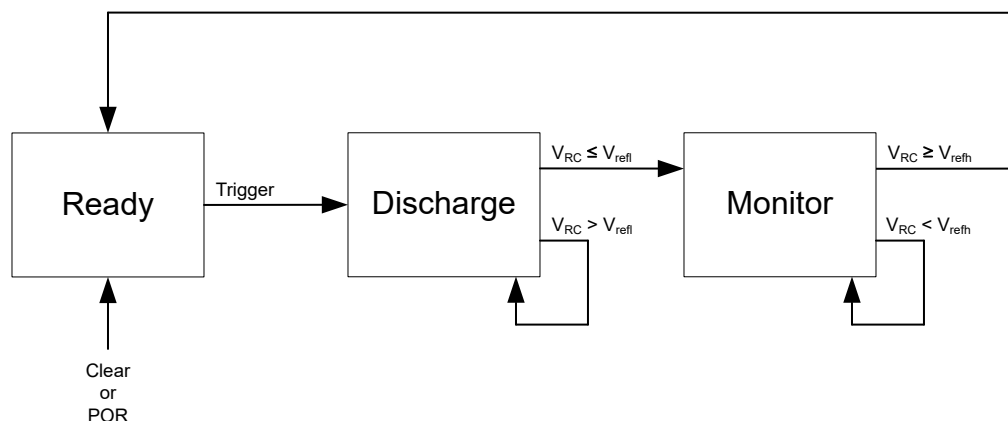

Figure 7-2. State Machine Diagram

In the *ready* state, the TPUL2G223 shorts the RC pin to V_{CC} and holds the digital output inactive.

When triggered, the state machine changes to the *discharge* state. The digital output is immediately set to active and the device internally shorts the RC pin to ground, discharging the external timing capacitor. Triggers while in the Discharge or Monitor state are ignored.

The state machine changes from the *discharge* state to the *monitor* state when the RC pin reaches the low reference voltage ($V_{refl} = 0.25V_{CC}$). The RC pin is then set to high impedance, allowing the external timing circuit to naturally charge the timing capacitor back to V_{CC} . When the RC voltage reaches the high reference voltage ($V_{refh} = 0.69V_{CC}$), the state machine returns to the *ready* state.

Table 7-1. State Descriptions

State Name	Inputs				Outputs ⁽¹⁾		
	Trigger	$V_{RC} \leq V_{refl}$	$V_{RC} \geq V_{refh}$	CLR	RC	Q	\bar{Q}
Ready	Discharge	Ready	Ready	Ready	H	L	H
Discharge	Discharge	Monitor	Discharge	Ready	L	H	L
Monitor	Monitor	Monitor	Ready	Ready	Z	H	L

(1) H = Driving high, L = Driving low, Z = High impedance

7.2 Functional Block Diagram

$$V_{refh} = 0.69 \times V_{CC}$$

$$V_{refl} = 0.25 \times V_{CC}$$

C_{int} indicates total internal parasitic capacitance and can be found in the *Electrical Characteristics* table.

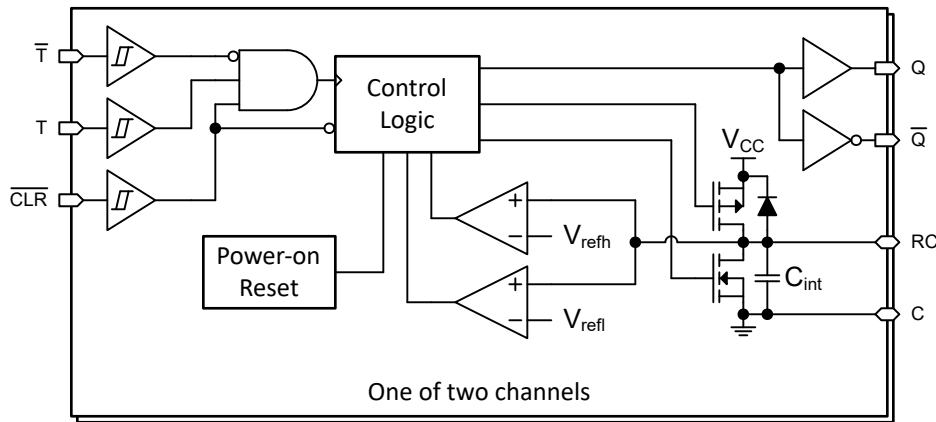

7.3 Feature Description

7.3.1 Naming Convention

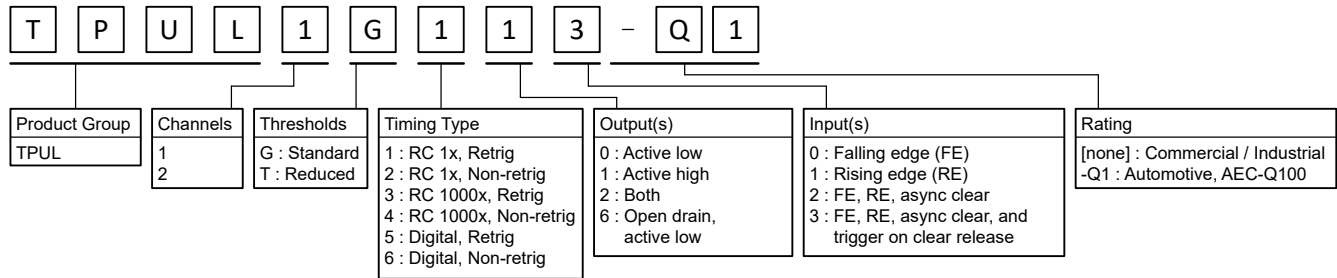

Figure 7-3. Device name meaning

7.3.2 Non-Retriggerable One-Shot

This device includes a non-retriggerable monostable multivibrator (one-shot) circuit that produces a fixed-width output pulse. The output pulse width for a non-retriggerable one-shot remains constant and is not impacted by additional triggers while the output is active. The output pulse will expire after the configured time period measured from the first trigger received.

7.3.3 Timing Mechanism and Accuracy

The output pulse width (t_{wo}) is controlled by the selection of external timing components R_{ext} and C_{ext} . The TPUL2G223 has been designed to target a typical output pulse width of $t_{wo} \cong R_{ext} \times C_{ext}$, however the actual pulse width changes with multiple variables, and thus a nonlinearity correction factor, K , is added to provide the system designer with a more accurate pulse width estimation. Equation 1 is used to most accurately predict the output pulse width.

$$t_{wo} = K \times R_{ext} \times C_{ext} \quad (1)$$

The output pulse width is dependent on multiple variables:

- External timing components (R_{ext} , C_{ext})
- Voltage
- Temperature
- Manufacturing and design

The external timing component values directly control the output pulse width, and any variations in component values due to manufacturing, voltage, aging, or temperature will directly impact the output pulse width.

Most resistors maintain very consistent values during operation, and thus tend to have little impact on accuracy.

Most capacitors have a wide variation of manufacturing values, and additionally can vary due to age, temperature, and operating voltage. Typically, the timing capacitor is the largest single source of error for RC timed monostable multivibrators.

There is also some error introduced by the TPUL2G223. This error is provided as Δt_{wo} in the *Switching Characteristics* section and includes variations due to design, manufacturing, and temperature.

Estimating the percent error of the output pulse width ($e_{\Delta t_{wo}}$) requires multiple inputs. Equation 2 provides the best method to estimate total pulse width error due to tolerance of components, with e_R being the error introduced by the timing resistor, e_C being the error introduced by the timing capacitor, and Δt_{wo} being the error introduced by the TPUL2G223. There is additionally some randomness inherent to the pulse width even with all other factors held constant which is typically less than 1% and is accounted for in the Δt_{wo} specification.

$$e_{\Delta t_{wo}} = e_R + e_C + e_{ReC} + \Delta t_{wo}(1 + e_R + e_C + e_{ReC}) \quad (2)$$

For a quick estimate, the sum of the error values can be used ($e_{\Delta t_{wo}} \cong e_R + e_C + \Delta t_{wo}$). For example, a TPUL2G223 application circuit using a very good Class I (C0G) capacitor with 2% manufacturing tolerance + 0.3% (30ppm/°C) temperature variation, 0.1% resistor, and $\Delta t_{wo(max)}$ of 10% would have a quickly estimated maximum error of 12.4%. With the more accurate equation, the maximum error is actually 12.64%.

7.3.4 Balanced CMOS Push-Pull Outputs

This device includes balanced CMOS push-pull outputs. The term *balanced* indicates that the device can sink and source similar currents. The drive capability of this device may create fast edges into light loads, so routing and load conditions should be considered to prevent ringing. Additionally, the outputs of this device are capable of driving larger currents than the device can sustain without being damaged. It is important to limit the output power of the device to avoid damage due to overcurrent. The electrical and thermal limits defined in the *Absolute Maximum Ratings* must be followed at all times.

Unused push-pull CMOS outputs must be left disconnected.

7.3.5 CMOS Schmitt-Trigger Inputs

This device includes inputs with the Schmitt-trigger architecture. These inputs are high impedance and are typically modeled as a resistor in parallel with the input capacitance given in the *Electrical Characteristics* table from the input to ground. The worst case resistance is calculated with the maximum input voltage, given in the *Absolute Maximum Ratings* table, and the maximum input leakage current, given in the *Electrical Characteristics* table, using Ohm's law ($R = V \div I$).

The Schmitt-trigger input architecture provides hysteresis as defined by ΔV_T in the *Electrical Characteristics* table, which makes this device extremely tolerant to slow or noisy inputs. While the inputs can be driven much slower than standard CMOS inputs, it is still recommended to properly terminate unused inputs. Driving the inputs with slow transitioning signals will increase dynamic current consumption of the device with the maximum value per input defined as ΔI_{CC} in the *Electrical Characteristics* table. For additional information regarding Schmitt-trigger inputs, please see [Understanding Schmitt Triggers](#).

Do not leave inputs floating at any time during operation. Unused inputs must be terminated at a valid high or low voltage level. If a system is not actively driving an input at all times, then a pull-up or pull-down resistor can be added to provide a valid input voltage during these times. The resistor value will depend on multiple factors; however, a 10kΩ resistor is recommended and will typically meet all requirements.

7.3.6 Latching Logic with Known Power-Up State

This device includes latching logic circuitry. Latching circuits commonly include D-type latches and D-type flip-flops, but include all logic circuits that act as volatile memory. In typical logic devices, the output state of each latching circuit is unknown after power is initially applied; however, this device includes an added Power On Reset (POR) circuit which sets the states of all included latching circuits during the power-up ramp prior to the device starting normal functionality.

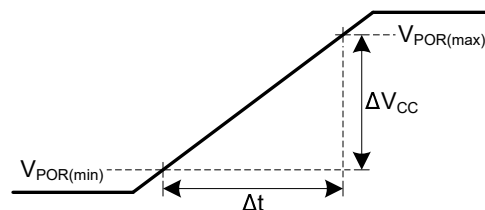

Figure 7-4. Supply (V_{CC}) Ramp Characteristics for Known Power-Up State

Figure 7-4 shows a correct supply voltage turn-on ramp and defines values used in the *Recommended Operating Conditions* and *Electrical Characteristics* tables.

Prior to starting the power-on ramp, the supply must be completely off ($V_{CC} \leq V_{POR(min)}$).

The supply voltage must ramp at a rate within the range provided in the *Recommended Operating Conditions* table.

The output state of each latching logic circuit only remains stable as long as power is applied to the device ($V_{CC} \geq V_{POR(max)}$).

Variation from these recommendations will result in the device having an unknown power-up state.

7.3.7 Partial Power Down (I_{off})

This device includes circuitry to disable all outputs when the supply pin is held at 0V. When disabled, the outputs will neither source nor sink current, regardless of the input voltages applied. The amount of leakage current at each output is defined by the I_{off} specification in the *Electrical Characteristics* table.

7.3.8 Clamp Diode Structure

Figure 7-5 shows the inputs and outputs to this device have negative clamping diodes only.

CAUTION

Voltages beyond the values specified in the *Absolute Maximum Ratings* table can cause damage to the device. The input and output voltage ratings may be exceeded if the input and output clamp-current ratings are observed.

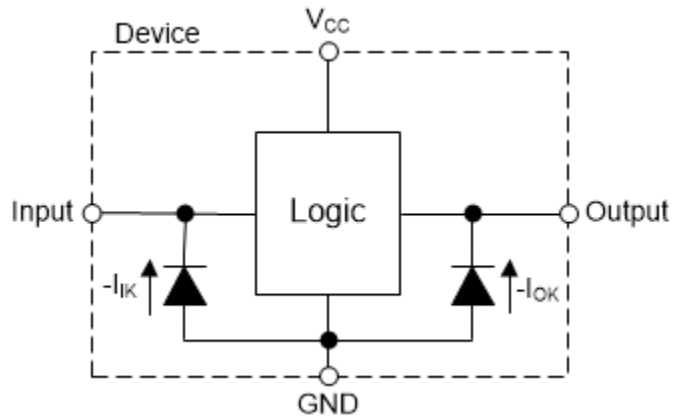

Figure 7-5. Electrical Placement of Clamping Diodes for Each Input and Output

7.4 Device Functional Modes

7.4.1 Off-State Operation

The TPUL2G223 includes partial-power-down (I_{off}) protection, which forces the outputs into a high-impedance state when the supply voltage is approximately 0V. In the powered-off state, voltages can be applied to the digital inputs and outputs and the device will not respond or have any back-powering. This protection does not apply to the RC pin.







7.4.2 Startup Operation

The TPUL2G223 includes an internal power-on reset (POR) circuit that prevents erroneous triggers from occurring during startup. There are details on the supply ramp requirements provided in *Latching Logic with Known Power-Up State*. Normal operation can be started after the startup time ($t_{startup}$) has expired per the *Timing Requirements* table. While active, the POR circuit holds the TPUL2G223 in the *Ready* state.



7.4.3 On-State Operation

The table below lists the on-state functional modes for the TPUL2G223.

Table 7-2. Function Table

INPUTS ⁽¹⁾			OUTPUTS ⁽²⁾	
CLR	T	T	Q	Q̄
L	X	X	L	H
H	H	X	L ⁽³⁾	H ⁽³⁾
H	X	L	L ⁽³⁾	H ⁽³⁾
H	L	↑	 ⁽⁴⁾	 ⁽⁴⁾
H	↓	H	 ⁽⁴⁾	 ⁽⁴⁾
↑	L	H	 ⁽⁴⁾	 ⁽⁴⁾

(1) H = high voltage level, L = low voltage level, X = don't care

(2) L = driving low, H = driving high,  = driving high for the defined pulse width time,  = driving low for the defined pulse width time

(3) These outputs are based on the assumption that the indicated steady-state conditions at the inputs have been set up long enough to complete any output pulse.

(4) If a trigger occurs during an active output pulse, the new trigger is ignored and the output pulse terminates one pulse width after the original trigger.

8 Application and Implementation

Note

Information in the following applications sections is not part of the TI component specification, and TI does not warrant its accuracy or completeness. TI's customers are responsible for determining suitability of components for their purposes, as well as validating and testing their design implementation to confirm system functionality.

8.1 Application Information

The TPUL2G223 is used to generate a fixed-width pulse from an input trigger event. This device is non-retriggerable, meaning that input triggers received while the output is active will be ignored and the output pulse will expire one configured time period after the first trigger.

The input trigger event comes from three gated inputs: \bar{T} , T, and \bar{CLR} . These inputs are combined in a 3-input AND gate, with \bar{T} internally inverted such that the logic follows the boolean equation $Y = !(\bar{T}) \cdot T \cdot \bar{CLR}$. Each input has a Schmitt-trigger architecture, and thus includes hysteresis allowing for slow transitioning or noisy signals. An input signal is detected as a logic high if the signal is larger than V_{T+} , and a low if the input signal is smaller than V_{T-} . Between V_{T+} and V_{T-} , the input signal is detected as the last valid state until one of those values is crossed. An output pulse is triggered on the rising edge of the aforementioned internal Y signal.

The output pulse width is controlled by the selection of external timing components R_{ext} and C_{ext} . Plots are provided in the *Typical Characteristics* section to easily select appropriate component values for a desired pulse width. See the *Features* section for additional information regarding the impact of external components on the timing accuracy of the TPUL2G223.

8.2 Typical Application - Edge Detector

In this application, the TPUL2G223 is used to detect rising or falling edges on an input signal, producing short pulses at the output for each edge detected. The circuit configuration for a rising edge detector is shown in [Figure 8-1](#). For a falling edge detector, connect the input signal to the \bar{T} input instead of the T input, and connect the T input to V_{CC} . Otherwise, the components and configuration are identical.

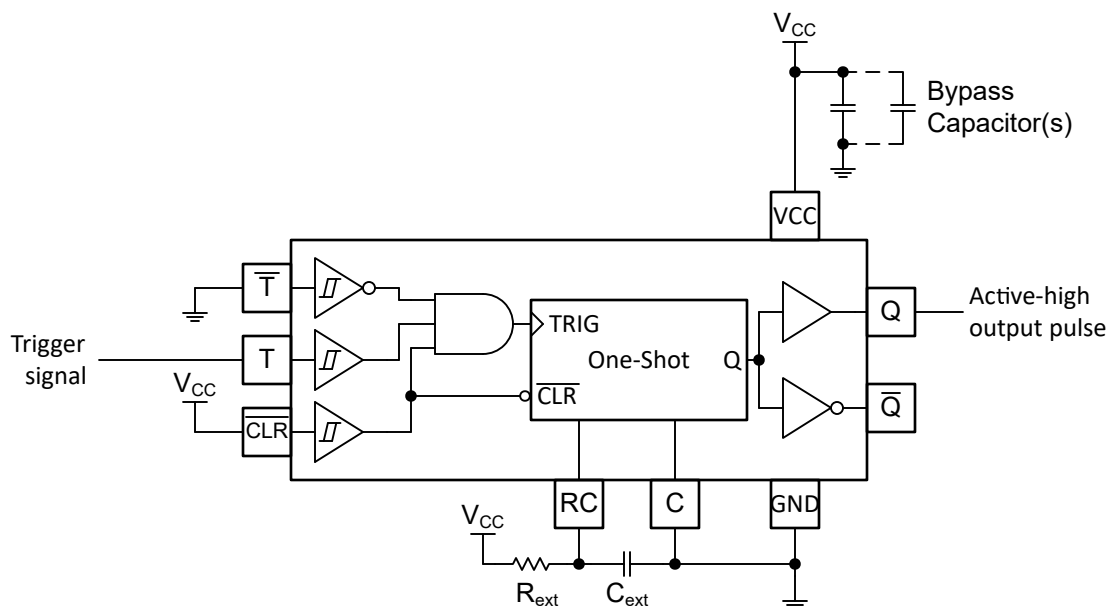

Figure 8-1. Pulse Generator Schematic Using the TPUL2G223

8.2.1 Design Requirements

8.2.1.1 Timing Components

The external timing components directly determine the output pulse width of the TPUL2G223.

The range of supported values for R_{ext} and C_{ext} are provided in the *Recommended Operating Conditions* table. Do not exceed the limits provided in the *Absolute Maximum Ratings* table.

The TPUL2G223 can be used with no external capacitor, which is described as $C_{ext} = 0pF$. In this condition, the output pulse width is determined by the operating voltage and external timing resistor, R_{ext} , only. The expected variation is provided in the *Switching Characteristics* table for the case of $R_{ext} = 10k\Omega$, $C_{ext} = 0pF$.

If an external timing capacitor larger than $1\mu F$ is used, add an external Schottky diode (D_{ext}) as shown in [Figure 8-2](#) to provide an alternate discharge path for the capacitor during power down.

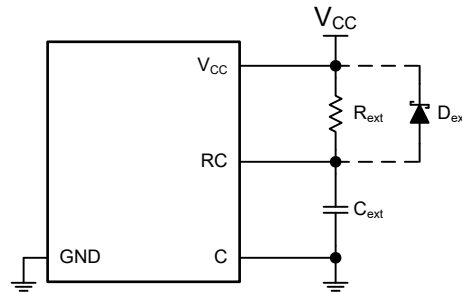

Figure 8-2. External protection diode connection

8.2.1.2 Input Considerations

Input signals must cross $V_{T-(min)}$ to be considered a logic LOW, and $V_{T+(max)}$ to be considered a logic HIGH. Do not exceed the maximum input voltage range found in the *Absolute Maximum Ratings*.

Unused inputs must be terminated to either V_{CC} or ground. The unused inputs can be directly terminated if the input is completely unused, or they can be connected with a pull-up or pull-down resistor if the input will be used sometimes but not always. A pull-up resistor is used for a default state of HIGH, and a pull-down resistor is used for a default state of LOW. The drive current of the controller, leakage current into the TPUL2G223 (as specified in the *Electrical Characteristics*), and the desired input transition rate limits the resistor size. A $10k\Omega$ resistor value is recommended for most applications.

The TPUL2G223 has no input signal transition rate requirements because it has Schmitt-Trigger inputs. However, it is characterized for operation within the limits provided in the *Recommended Operating Conditions* table.

Schmitt-Trigger inputs also provide significant noise rejection. However, noise with a large enough amplitude can still cause issues. Refer to the hysteresis value, $\Delta V_{T-(min)}$ in the *Electrical Characteristics*, which will provide the peak-to-peak noise rejection limit.

Unlike what happens with standard CMOS inputs, Schmitt-Trigger inputs can be held at any valid voltage value without causing dangerously large increases in power consumption. The maximum additional current caused by holding an input at a value other than V_{CC} or ground is provided as ΔI_{CC} in the *Electrical Characteristics* table.

Refer to the *Feature Description* section for additional information regarding the inputs for this device.

8.2.1.3 Output Considerations

The positive supply voltage is used to produce the output HIGH-state voltage. Drawing current from the output decreases the output voltage as specified by the V_{OH} specification in the *Electrical Characteristics*. The ground voltage is used to produce the output LOW-state voltage. Sinking current into the output increases the output voltage as specified by the V_{OL} specification in the *Electrical Characteristics*.

Push-pull outputs that could be in opposite states, even for a very short time period, should never be connected directly together to avoid excessive current and damage to the device.

The TPUL2G223 can directly drive a load with a total capacitance less than or equal to 50pF while still meeting all of the data sheet specifications. For larger capacitive loads, add a series resistor to maintain current within the *Absolute Maximum Ratings*.

The TPUL2G223 can drive a load with total resistance described by $R_L \geq V_O / I_O$, with the output voltage and current defined in the *Electrical Characteristics* table with V_{OH} and V_{OL} . When outputting in the HIGH state, the output voltage in the equation is defined as the difference between the measured output voltage and the supply voltage at the V_{CC} pin.

Unused outputs can be left floating. Do not connect outputs directly to V_{CC} or ground.

Refer to the *Feature Description* section for additional information regarding the outputs for this device.

8.2.1.4 Power Considerations

Ensure the desired supply voltage is within the range specified in the *Recommended Operating Conditions*. The supply voltage sets the electrical characteristics of the device as described in the *Electrical Characteristics* section.

The positive voltage supply must be capable of sourcing current equal to the total current to be sourced by all outputs of the TPUL2G223 plus the maximum static supply current, I_{CC} , listed in the *Electrical Characteristics*, and any transient current required for switching. The logic device can only source as much current as is provided by the positive supply source. Ensure the maximum total current through V_{CC} listed in the *Absolute Maximum Ratings* is not exceeded. After the output pulse is complete, the external capacitor is quickly recharged to V_{CC} using the supply with maximum current draw as described by $I_{Cext(max)}$ in the *Electrical Characteristics*. Additionally, the external timing circuitry will draw power from the supply with a maximum current draw of $I_{ext(max)} = V_{CC} / R_{ext}$, which is pulled directly from the supply and thus is not part of the I_{CC} value for the TPUL2G223. The dynamic power consumption from the external circuit can be estimated by $P_{RC} = C_{ext} V_{CC}^2 / t_{wo}$.

The ground must be capable of sinking current equal to the total current to be sunk by all outputs of the TPUL2G223 plus the maximum supply current, I_{CC} , listed in the *Electrical Characteristics*, and any transient current required for switching. The logic device can only sink as much current that can be sunk into its ground connection. Ensure the maximum total current through GND listed in the *Absolute Maximum Ratings* is not exceeded.

Thermal increase can be calculated using the information provided in [Thermal Characteristics of Standard Linear and Logic \(SLL\) Packages and Devices](#).

CAUTION

The maximum junction temperature, $T_{J(max)}$ listed in the *Absolute Maximum Ratings*, is an additional limitation to prevent damage to the device. Do not violate any values listed in the *Absolute Maximum Ratings*. These limits are provided to prevent damage to the device.

8.2.2 Detailed Design Procedure

Texas Instruments provides an Excel-based calculator for getting the best results when using the TPUL2G223. This calculator can be found through the device's product folder, located in the *Design and development* section. The steps below are used for manually calculating the required timing component values using the information available in this document.

1. Select the desired output pulse width, which will be referred to as t_{wo} .
2. Solve: $C_{ext1} = t_{wo}/50000$.
3. Select the nearest decade capacitor value to C_{ext1} from the following and use for C_{ext} . { 100pF, 1nF, 10nF, 100nF, 1 μ F, 10 μ F }
4. Solve: $R_{ext1} = t_{wo}/C_{ext}$.
5. Using R_{ext1} from step 4 and C_{ext} from step 3, find the closest K factor using the appropriate plot from the *Typical Characteristics* section.
6. Solve: $R_{ext} = t_{wo}/(K \times C_{ext})$
7. Connect the selected timing resistor, R_{ext} , from RC to V_{CC} .
8. Connect the selected timing capacitor, C_{ext} , from RC (positive) to C (negative). The C pin can additionally be connected to ground, however it is not required for normal operation.
9. Add a 0.1 μ F bypass capacitor from V_{CC} to GND. The capacitor needs to be placed physically close to the device and electrically close to both the V_{CC} and GND pins. An example layout is shown in the *Layout* section.
10. Ensure the capacitive load at the output is ≤ 50 pF. This is not a hard limit, however, it will optimize performance and prevent reliability issues. This can be accomplished by providing short, appropriately sized traces from the TPUL2G223 to any receiving devices.
11. Ensure the resistive load at the output is larger than $(V_{CC} / I_{O(max)})\Omega$. Doing this will prevent the maximum output current from the *Absolute Maximum Ratings* from being violated. Most CMOS inputs have a resistive load measured in M Ω ; much larger than the minimum calculated previously.
12. Thermal issues are rarely a concern for TPUL family devices, however, the power consumption and thermal increase can be calculated using the steps provided in the application report, [CMOS Power Consumption and Cpd Calculation](#).

8.2.3 Application Curves

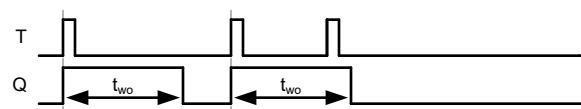

Figure 8-3. Output Pulse Timing Diagram

8.3 Typical Application - Delayed Pulse Generator

In this application, the TPUL2G223 is used to produce a delayed output pulse from a rising edge input trigger. The circuit configuration is shown in Figure 8-4.

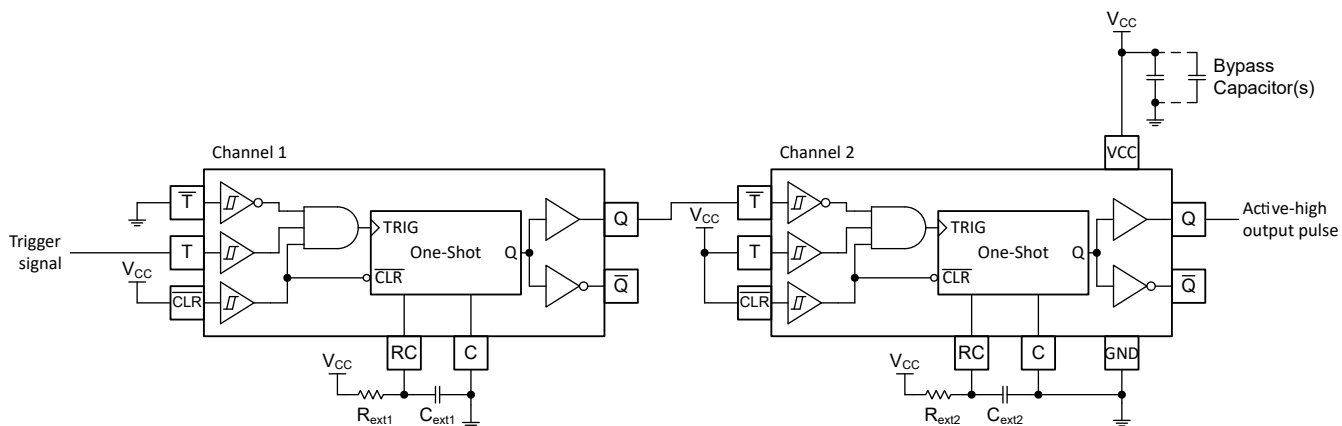

Figure 8-4. Delayed Pulse Generation Schematic Using the TPUL2G223

8.3.1 Application Curves

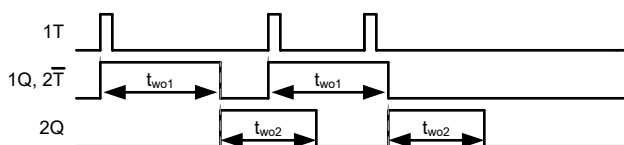

Figure 8-5. Output Pulse Timing Diagram

8.4 Power Supply Recommendations

The power supply can be any voltage between the minimum and maximum supply voltage rating listed in the *Recommended Operating Conditions*.

During startup, the power supply should ramp within the provided power-up ramp rate range in the *Recommended Operating Conditions* table.

Each V_{CC} terminal must have a good bypass capacitor to prevent power disturbance. For normal operation of the TPUL2G223, a $0.1\mu\text{F}$ bypass capacitor is recommended. To reject different frequencies of noise, use multiple bypass capacitors in parallel. Capacitors with values of $0.1\mu\text{F}$ and $1\mu\text{F}$ are commonly used in parallel.

8.5 Layout

8.5.1 Layout Guidelines

- Timing component placement
 - Place near the device
 - Provide an electrically short path to the device terminal connections
- Bypass capacitor placement
 - Place near the positive supply terminal of the device
 - Provide an electrically short ground return path
 - Use wide traces to minimize impedance
 - Keep the device, capacitors, and traces on the same side of the board whenever possible
- Signal trace geometry
 - 8mil to 12mil trace width
 - Lengths less than 12cm to minimize transmission line effects
 - Avoid 90° corners for signal traces
 - Use an unbroken ground plane below signal traces
 - Flood fill areas around signal traces with ground
 - For traces longer than 12cm
 - Use impedance controlled traces
 - Source-terminate using a series damping resistor near the output
 - Avoid branches; buffer signals that must branch separately

8.5.2 Layout Example

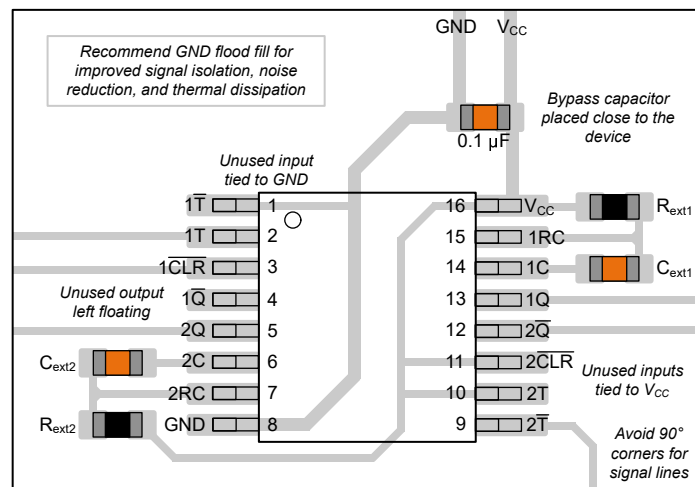

Figure 8-6. Layout Example for TPUL2G223 in the PW (TSSOP) package

9 Device and Documentation Support

TI offers an extensive line of development tools. Tools and software to evaluate the performance of the device, generate code, and develop solutions are listed below.

9.1 Documentation Support

9.1.1 Related Documentation

For related documentation, see the following:

- Texas Instruments, [CMOS Power Consumption and \$C_{pd}\$ Calculation application note](#)
- Texas Instruments, [Designing With Logic application note](#)
- Texas Instruments, [Thermal Characteristics of Standard Linear and Logic \(SLL\) Packages and Devices application note](#)

9.2 Receiving Notification of Documentation Updates

To receive notification of documentation updates, navigate to the device product folder on ti.com. Click on *Notifications* to register and receive a weekly digest of any product information that has changed. For change details, review the revision history included in any revised document.

9.3 Support Resources

TI E2E™ [support forums](#) are an engineer's go-to source for fast, verified answers and design help — straight from the experts. Search existing answers or ask your own question to get the quick design help you need.

Linked content is provided "AS IS" by the respective contributors. They do not constitute TI specifications and do not necessarily reflect TI's views; see TI's [Terms of Use](#).

9.4 Trademarks

TI E2E™ is a trademark of Texas Instruments.

All trademarks are the property of their respective owners.

9.5 Electrostatic Discharge Caution



This integrated circuit can be damaged by ESD. Texas Instruments recommends that all integrated circuits be handled with appropriate precautions. Failure to observe proper handling and installation procedures can cause damage.

ESD damage can range from subtle performance degradation to complete device failure. Precision integrated circuits may be more susceptible to damage because very small parametric changes could cause the device not to meet its published specifications.

9.6 Glossary

[TI Glossary](#) This glossary lists and explains terms, acronyms, and definitions.

10 Revision History

NOTE: Page numbers for previous revisions may differ from page numbers in the current version.

DATE	REVISION	NOTES
January 2026	*	Initial Release

11 Mechanical, Packaging, and Orderable Information

The following pages include mechanical, packaging, and orderable information. This information is the most current data available for the designated devices. This data is subject to change without notice and revision of this document. For browser-based versions of this data sheet, refer to the left-hand navigation.

PACKAGING INFORMATION

Orderable part number	Status (1)	Material type (2)	Package Pins	Package qty Carrier	RoHS (3)	Lead finish/ Ball material (4)	MSL rating/ Peak reflow (5)	Op temp (°C)	Part marking (6)
TPUL2G223BQBR	Active	Production	WQFN (BQB) 16	3000 LARGE T&R	Yes	NIPDAU SN	Level-1-260C-UNLIM	-40 to 125	2G223
TPUL2G223DR	Active	Production	SOIC (D) 16	-	Yes	NIPDAU	Level-1-260C-UNLIM	-40 to 125	2G223
TPUL2G223PWR	Active	Production	TSSOP (PW) 16	3000 LARGE T&R	Yes	NIPDAU	Level-1-260C-UNLIM	-40 to 125	2G223

(1) **Status:** For more details on status, see our [product life cycle](#).

(2) **Material type:** When designated, preproduction parts are prototypes/experimental devices, and are not yet approved or released for full production. Testing and final process, including without limitation quality assurance, reliability performance testing, and/or process qualification, may not yet be complete, and this item is subject to further changes or possible discontinuation. If available for ordering, purchases will be subject to an additional waiver at checkout, and are intended for early internal evaluation purposes only. These items are sold without warranties of any kind.

(3) **RoHS values:** Yes, No, RoHS Exempt. See the [TI RoHS Statement](#) for additional information and value definition.

(4) **Lead finish/Ball material:** Parts may have multiple material finish options. Finish options are separated by a vertical ruled line. Lead finish/Ball material values may wrap to two lines if the finish value exceeds the maximum column width.

(5) **MSL rating/Peak reflow:** The moisture sensitivity level ratings and peak solder (reflow) temperatures. In the event that a part has multiple moisture sensitivity ratings, only the lowest level per JEDEC standards is shown. Refer to the shipping label for the actual reflow temperature that will be used to mount the part to the printed circuit board.

(6) **Part marking:** There may be an additional marking, which relates to the logo, the lot trace code information, or the environmental category of the part.

Multiple part markings will be inside parentheses. Only one part marking contained in parentheses and separated by a "-" will appear on a part. If a line is indented then it is a continuation of the previous line and the two combined represent the entire part marking for that device.

Important Information and Disclaimer: The information provided on this page represents TI's knowledge and belief as of the date that it is provided. TI bases its knowledge and belief on information provided by third parties, and makes no representation or warranty as to the accuracy of such information. Efforts are underway to better integrate information from third parties. TI has taken and continues to take reasonable steps to provide representative and accurate information but may not have conducted destructive testing or chemical analysis on incoming materials and chemicals. TI and TI suppliers consider certain information to be proprietary, and thus CAS numbers and other limited information may not be available for release.

In no event shall TI's liability arising out of such information exceed the total purchase price of the TI part(s) at issue in this document sold by TI to Customer on an annual basis.

OTHER QUALIFIED VERSIONS OF TPUL2G223 :

- Automotive : [TPUL2G223-Q1](#)

NOTE: Qualified Version Definitions:

- Automotive - Q100 devices qualified for high-reliability automotive applications targeting zero defects

TAPE AND REEL INFORMATION

QUADRANT ASSIGNMENTS FOR PIN 1 ORIENTATION IN TAPE

*All dimensions are nominal

Device	Package Type	Package Drawing	Pins	SPQ	Reel Diameter (mm)	Reel Width W1 (mm)	A0 (mm)	B0 (mm)	K0 (mm)	P1 (mm)	W (mm)	Pin1 Quadrant
TPUL2G223BQBR	WQFN	BQB	16	3000	180.0	12.4	2.8	3.8	1.2	4.0	12.0	Q1
TPUL2G223DR	SOIC	D	16	0	330.0	12.4	3.75	3.75	1.15	8.0	12.0	Q1
TPUL2G223PWR	TSSOP	PW	16	3000	330.0	12.4	6.9	5.6	1.6	8.0	12.0	Q1

TAPE AND REEL BOX DIMENSIONS

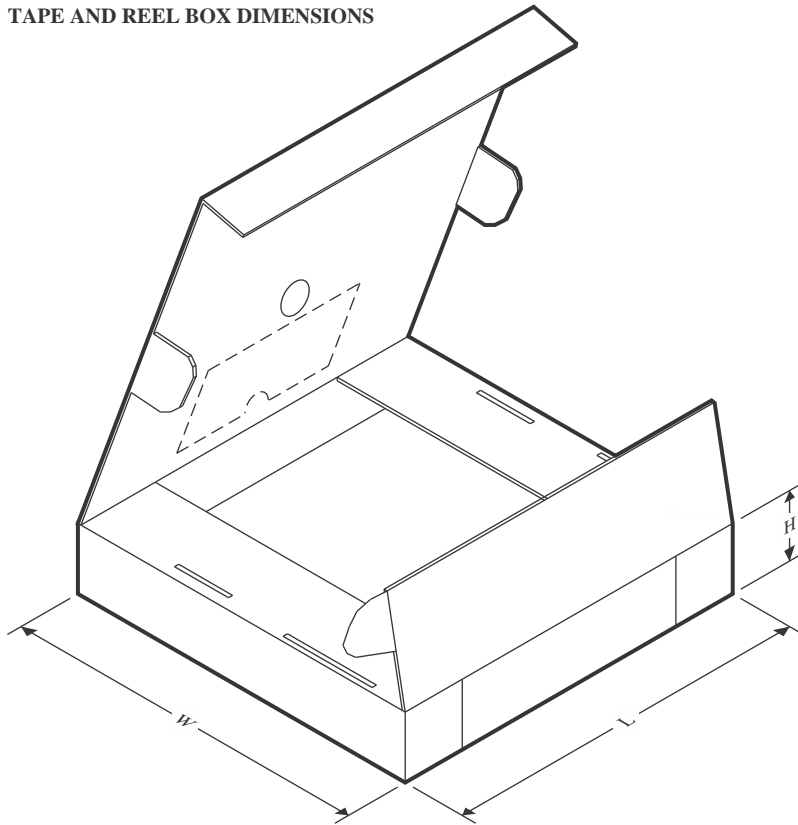

*All dimensions are nominal

Device	Package Type	Package Drawing	Pins	SPQ	Length (mm)	Width (mm)	Height (mm)
TPUL2G223BQBR	WQFN	BQB	16	3000	210.0	185.0	35.0
TPUL2G223DR	SOIC	D	16	0	340.5	336.1	32.0
TPUL2G223PWR	TSSOP	PW	16	3000	353.0	353.0	32.0

GENERIC PACKAGE VIEW

BQB 16

WQFN - 0.8 mm max height

2.5 x 3.5, 0.5 mm pitch

PLASTIC QUAD FLATPACK - NO LEAD

This image is a representation of the package family, actual package may vary.
Refer to the product data sheet for package details.

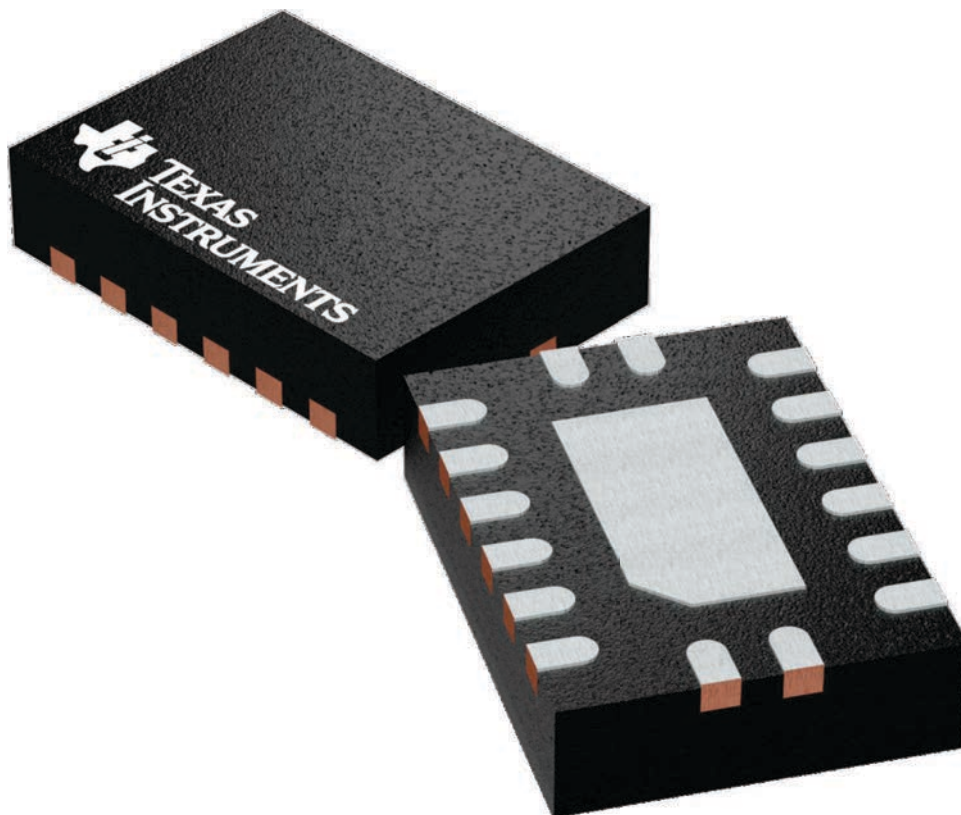

4226161/A

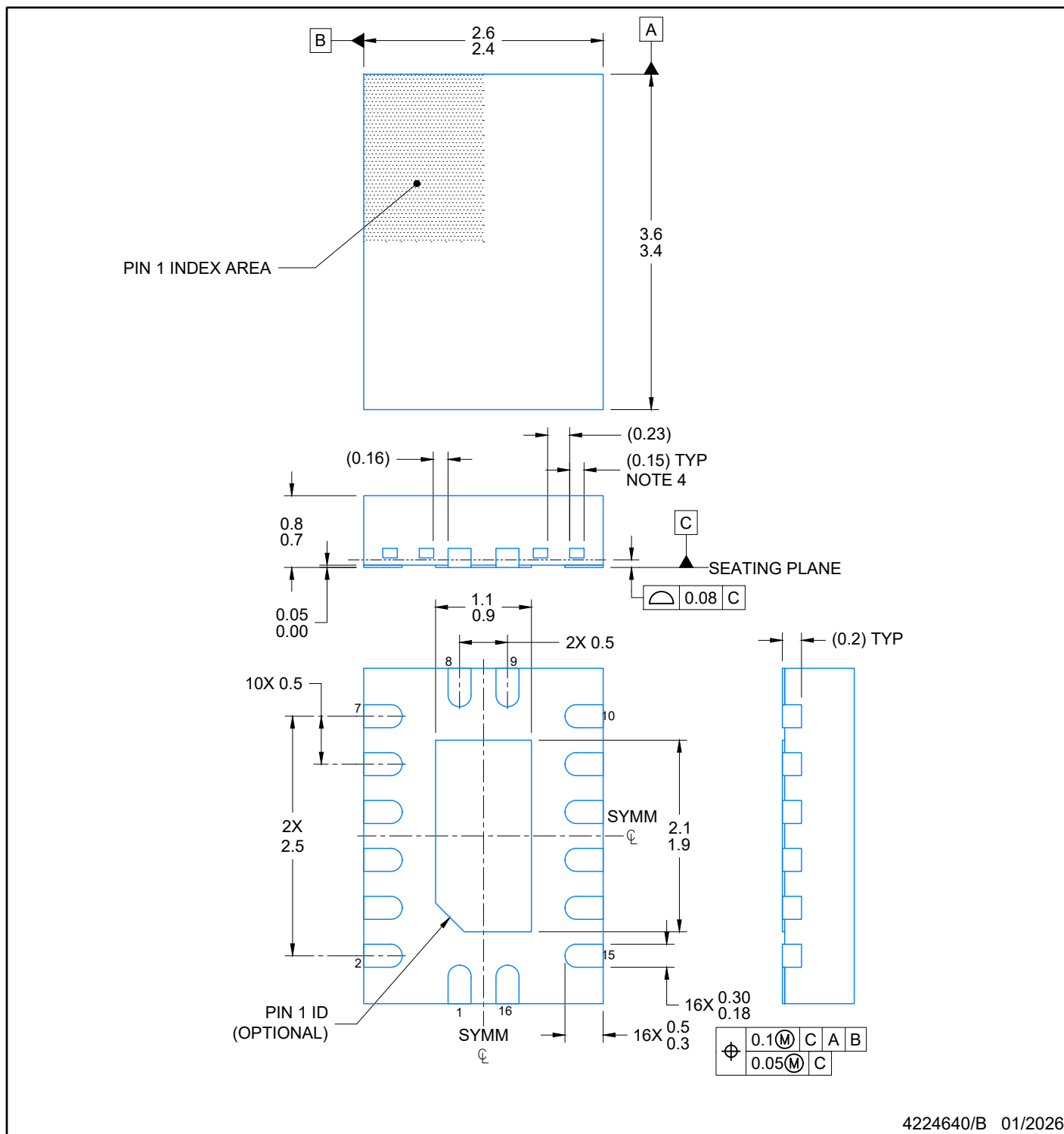

NOTES:

1. All linear dimensions are in millimeters. Any dimensions in parenthesis are for reference only. Dimensioning and tolerancing per ASME Y14.5M.
2. This drawing is subject to change without notice.
3. The package thermal pad must be soldered to the printed circuit board for optimal thermal and mechanical performance.
4. Features may differ or may not be present

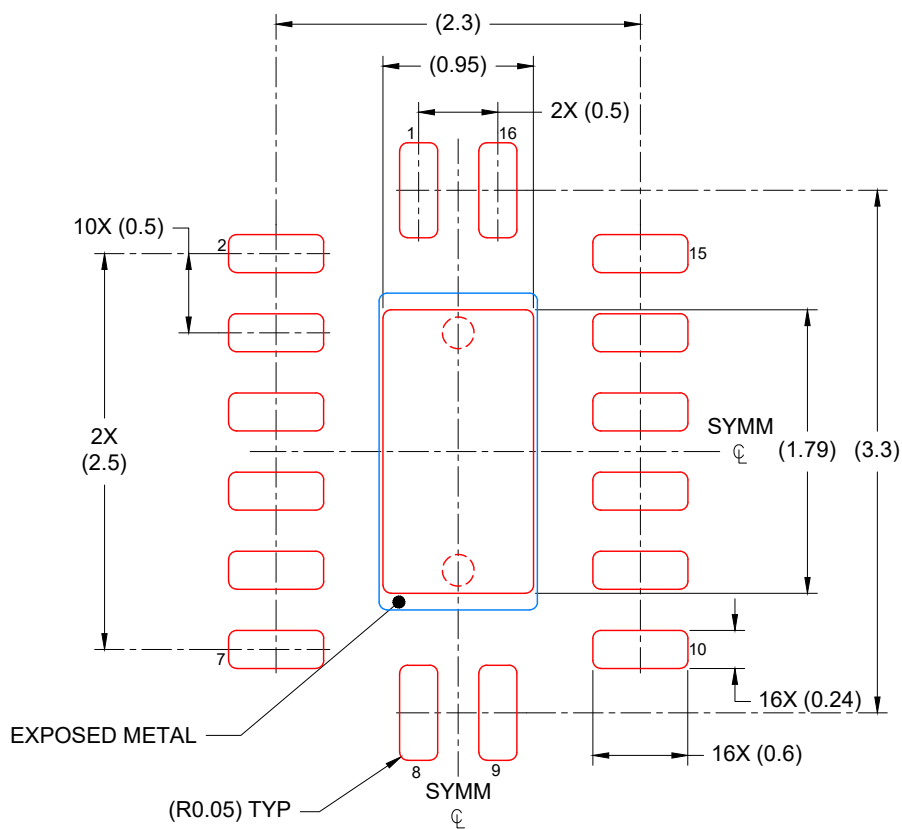

SOLDER PASTE EXAMPLE
 BASED ON 0.125 mm THICK STENCIL

EXPOSED PAD
 85% PRINTED COVERAGE BY AREA
 SCALE: 20X

4224640/B 01/2026

NOTES: (continued)

7. Laser cutting apertures with trapezoidal walls and rounded corners may offer better paste release. IPC-7525 may have alternate design recommendations.

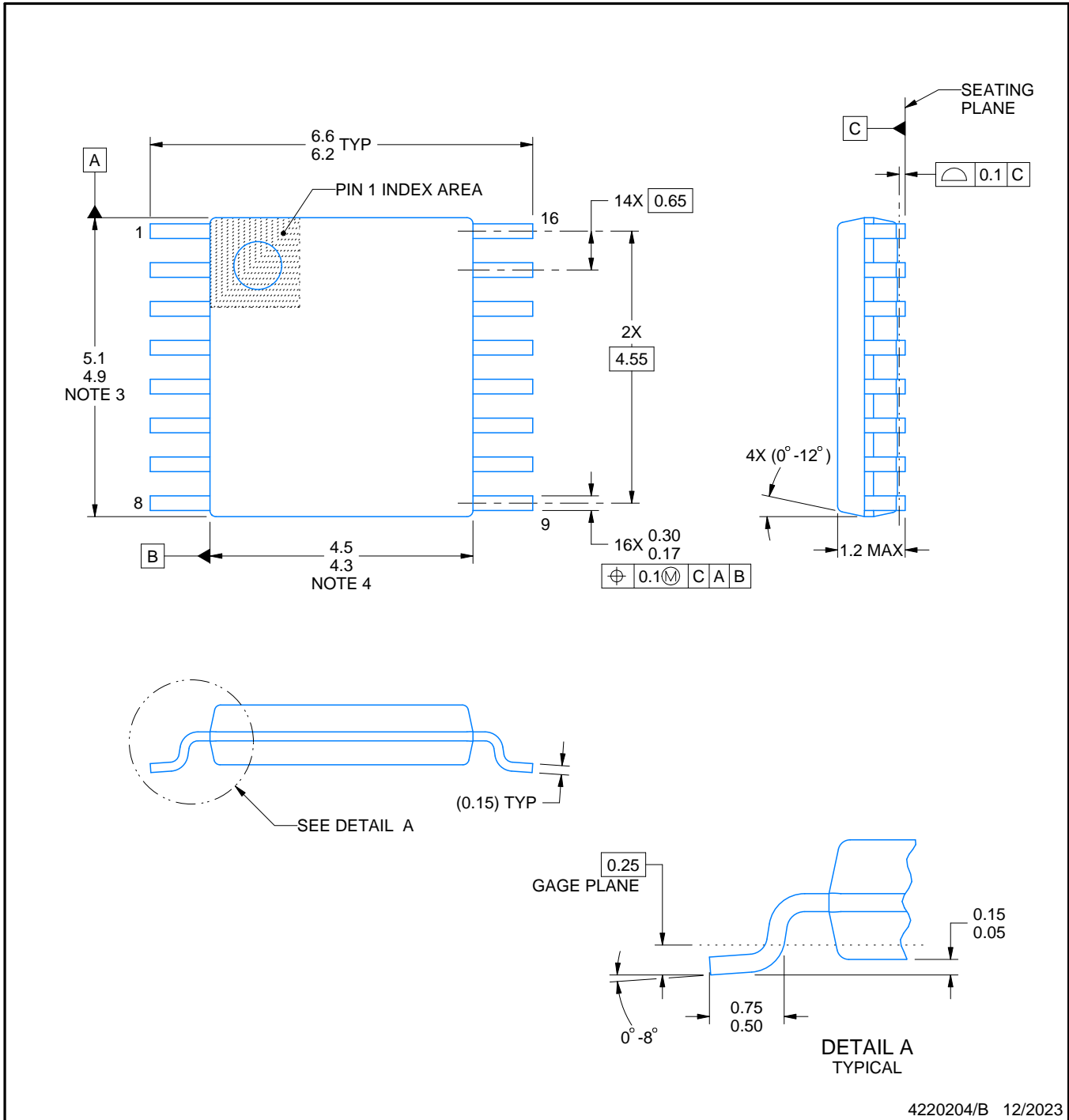
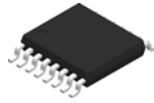

4220204/B 12/2023

NOTES:

1. All linear dimensions are in millimeters. Any dimensions in parenthesis are for reference only. Dimensioning and tolerancing per ASME Y14.5M.
2. This drawing is subject to change without notice.
3. This dimension does not include mold flash, protrusions, or gate burrs. Mold flash, protrusions, or gate burrs shall not exceed 0.15 mm per side.
4. This dimension does not include interlead flash. Interlead flash shall not exceed 0.25 mm per side.
5. Reference JEDEC registration MO-153.

EXAMPLE BOARD LAYOUT

PW0016A

TSSOP - 1.2 mm max height

SMALL OUTLINE PACKAGE

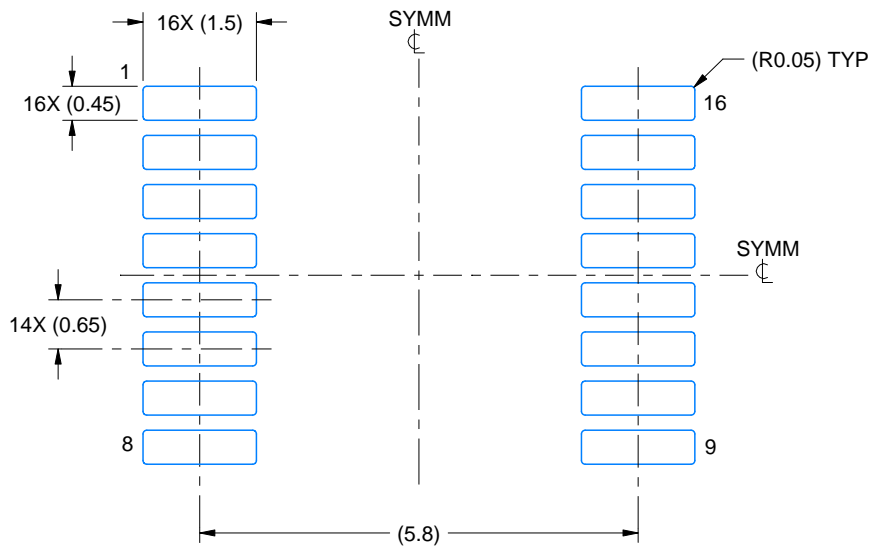

LAND PATTERN EXAMPLE
EXPOSED METAL SHOWN
SCALE: 10X

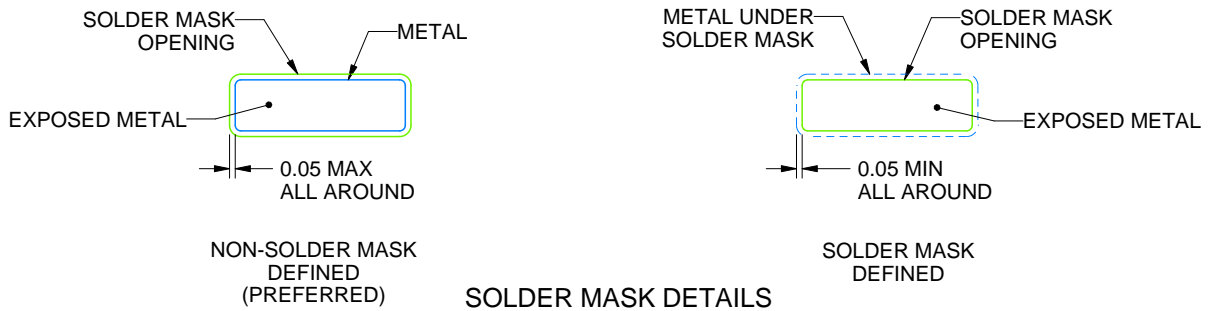

4220204/B 12/2023

NOTES: (continued)

- 6. Publication IPC-7351 may have alternate designs.
- 7. Solder mask tolerances between and around signal pads can vary based on board fabrication site.

EXAMPLE STENCIL DESIGN

PW0016A

TSSOP - 1.2 mm max height

SMALL OUTLINE PACKAGE

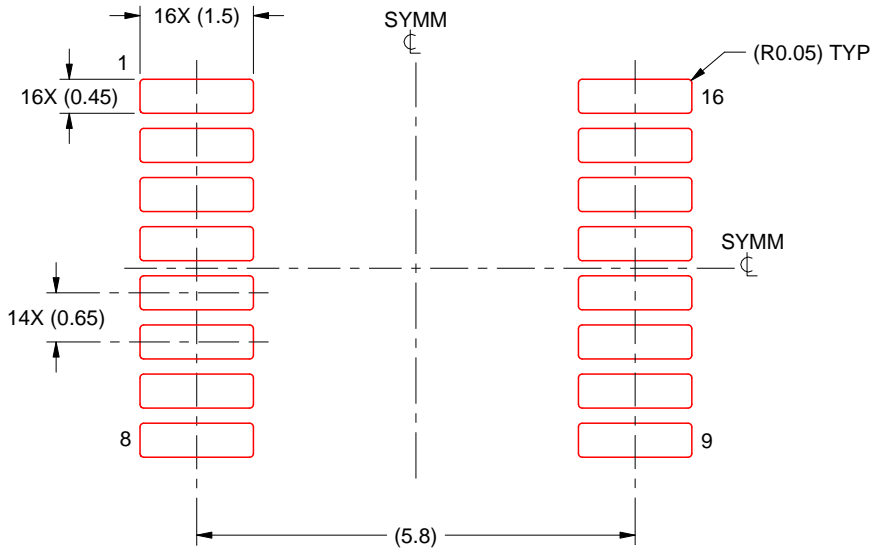

SOLDER PASTE EXAMPLE
BASED ON 0.125 mm THICK STENCIL
SCALE: 10X

4220204/B 12/2023

NOTES: (continued)

8. Laser cutting apertures with trapezoidal walls and rounded corners may offer better paste release. IPC-7525 may have alternate design recommendations.
9. Board assembly site may have different recommendations for stencil design.

D (R-PDSO-G16)

PLASTIC SMALL OUTLINE

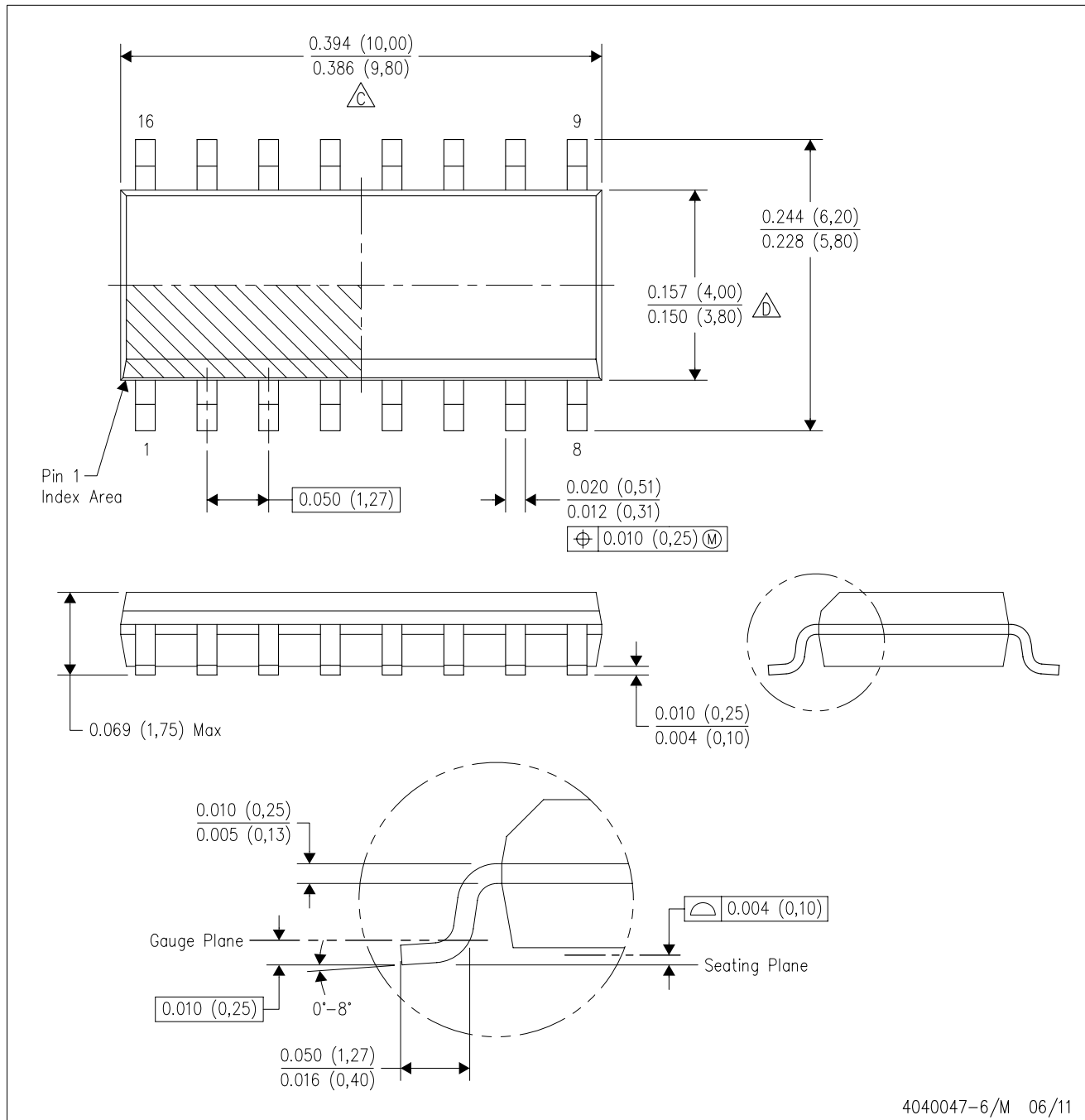

- NOTES:
- A. All linear dimensions are in inches (millimeters).
 - B. This drawing is subject to change without notice.
 - C. Body length does not include mold flash, protrusions, or gate burrs. Mold flash, protrusions, or gate burrs shall not exceed 0.006 (0,15) each side.
 - D. Body width does not include interlead flash. Interlead flash shall not exceed 0.017 (0,43) each side.
 - E. Reference JEDEC MS-012 variation AC.

IMPORTANT NOTICE AND DISCLAIMER

TI PROVIDES TECHNICAL AND RELIABILITY DATA (INCLUDING DATASHEETS), DESIGN RESOURCES (INCLUDING REFERENCE DESIGNS), APPLICATION OR OTHER DESIGN ADVICE, WEB TOOLS, SAFETY INFORMATION, AND OTHER RESOURCES "AS IS" AND WITH ALL FAULTS, AND DISCLAIMS ALL WARRANTIES, EXPRESS AND IMPLIED, INCLUDING WITHOUT LIMITATION ANY IMPLIED WARRANTIES OF MERCHANTABILITY, FITNESS FOR A PARTICULAR PURPOSE OR NON-INFRINGEMENT OF THIRD PARTY INTELLECTUAL PROPERTY RIGHTS.

These resources are intended for skilled developers designing with TI products. You are solely responsible for (1) selecting the appropriate TI products for your application, (2) designing, validating and testing your application, and (3) ensuring your application meets applicable standards, and any other safety, security, regulatory or other requirements.

These resources are subject to change without notice. TI grants you permission to use these resources only for development of an application that uses the TI products described in the resource. Other reproduction and display of these resources is prohibited. No license is granted to any other TI intellectual property right or to any third party intellectual property right. TI disclaims responsibility for, and you fully indemnify TI and its representatives against any claims, damages, costs, losses, and liabilities arising out of your use of these resources.

TI's products are provided subject to [TI's Terms of Sale](#), [TI's General Quality Guidelines](#), or other applicable terms available either on ti.com or provided in conjunction with such TI products. TI's provision of these resources does not expand or otherwise alter TI's applicable warranties or warranty disclaimers for TI products. Unless TI explicitly designates a product as custom or customer-specified, TI products are standard, catalog, general purpose devices.

TI objects to and rejects any additional or different terms you may propose.

Copyright © 2026, Texas Instruments Incorporated

Last updated 10/2025