

# Faster Charging Power Bank Turn-Key Solutions



## Product Bulletin

### Overview

With smartphones becoming more mainstream in today's mobile market, the demand for power banks as a reliable charging option continues to increase. Conventional power banks have increased battery capacity from 2000 mAh to 10,000 mAh to provide more energy for mobile applications.

Traditional linear chargers can support up to 1A charging, but require roughly 11 hours to fully charge a 10,000 mAh battery. Enabling faster, more efficient charging has become a major trend in power bank designs.

TI's new bq24195 series of switching chargers supports 4.5A maximum charging current at high efficiency and significantly reduces charging time to 3.5 hours for a 10,000 mAh battery, more than 3X faster than existing solutions. The single power stage buck/boost topology can also reduce system cost when using different operation modes. The combination of these new features can help differentiate your power bank solution, while maintaining high performance. Evaluation tools and complete turn-key solutions speed the design process to get to market faster.

### Key Features

- Complete charger module EVM from TI
- Fast charging
  - BQ24195L, 2.5A, 92% efficiency at 2A
  - BQ24195, 4.5A, 90% efficiency at 4A
- Boosts output capability
  - BQ24195L, 94% efficiency at 5.1V / 1A
  - BQ24195, 91% efficiency at 5.1V / 2.1A
- Input voltage regulation ( $V_{IN}$  DPM) to support third party adapters
- 1.5 MHz switching frequency
- 12 mΩ BAT-SYS FET
- SYSOFF minimizes battery leakage
- D+ /D- detection
- Supports BC1.2
- USB 2.0 / 3.0 current limit support
- 4x4 mm QFN package

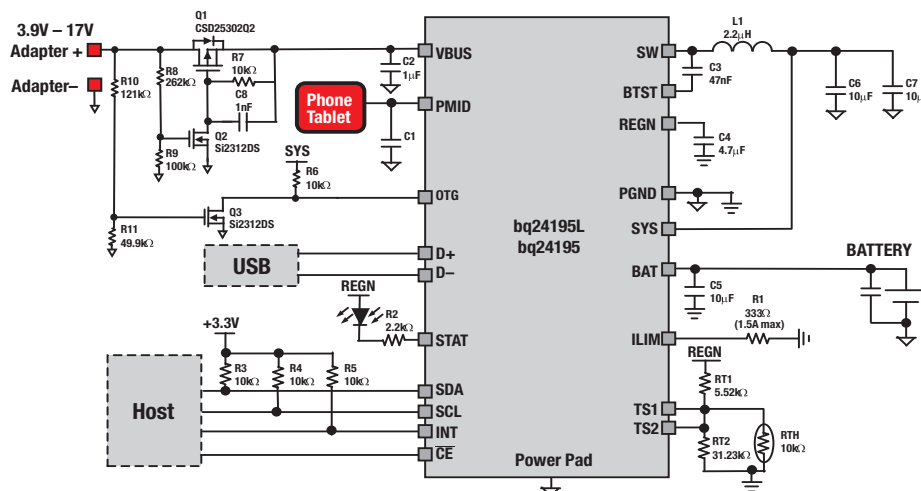

Recommended C1 (min) = 20 µF (bq24195L) or 6 µF (bq24195)

Application Schematic

# BQ24195 – Faster Charging Power Bank Solutions

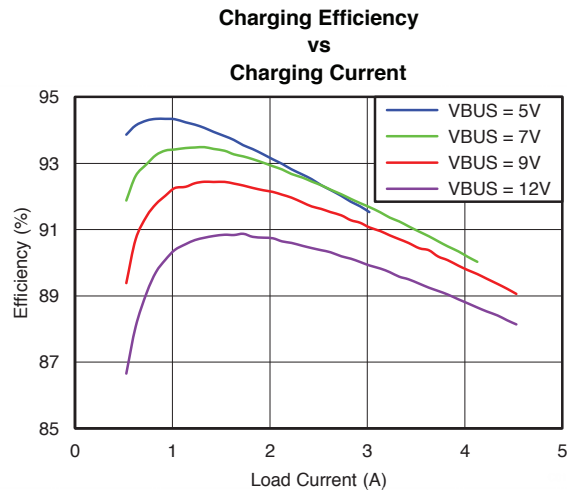

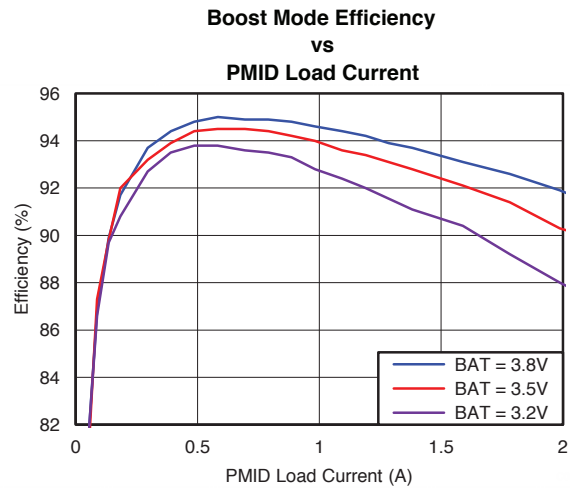

2.5A / 4.5A faster charging with bq24195.  
Up to 92% high charging efficiency with lower IC temperature.

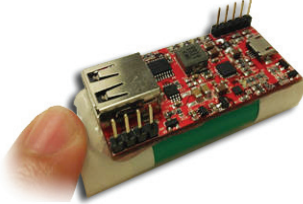
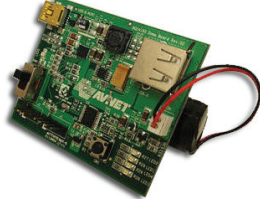

Up to 94% high synchronous boost efficiency and longer battery run time.

## Power bank turn-key solutions

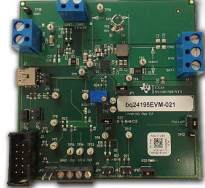
Tools	Board Image	Hardware BOM
<b>Avnet Prospect Board</b> Contact: Roger Hon <a href="mailto:roger.hon@avnet.com">roger.hon@avnet.com</a>		<ul style="list-style-type: none"> <li>• bq24195</li> <li>• MSP430G2332</li> <li>• TPS2511</li> <li>• TLV70030</li> <li>• CSD25302Q2</li> </ul>
<b>Avnet ADS Board</b> Contact: Jesh Ho <a href="mailto:jesh.ho@avnet.com">jesh.ho@avnet.com</a>		<ul style="list-style-type: none"> <li>• bq24195</li> <li>• MSP430G2232</li> <li>• TPS2511</li> <li>• TLV70025</li> <li>• CSD25302Q2</li> <li>• CSD16301Q2 x2</li> </ul>
<b>Wintech Board</b> Contact: Ethan Huang <a href="mailto:ethan.huang@wtmec.com">ethan.huang@wtmec.com</a>		<ul style="list-style-type: none"> <li>• bq24195</li> <li>• MSP430G2432</li> <li>• bq27510</li> <li>• INA214</li> <li>• TLV70028</li> <li>• CSD25302Q2, CSD25401Q3</li> </ul>
<b>BQ24195/L Evaluation Module</b> <a href="http://www.ti.com/tool/bq24195evm">http://www.ti.com/tool/bq24195evm</a>		Features for TI EVM <ul style="list-style-type: none"> <li>• bq24195/L</li> <li>• HPA172 USB interface adapter</li> <li>• bq2419x GUI for evaluation</li> <li>• bq24195/L User Guide</li> </ul>

Visit [www.ti.com/product/bq24195](http://www.ti.com/product/bq24195) for more information and to order samples.

## IMPORTANT NOTICE

Texas Instruments Incorporated and its subsidiaries (TI) reserve the right to make corrections, enhancements, improvements and other changes to its semiconductor products and services per JESD46, latest issue, and to discontinue any product or service per JESD48, latest issue. Buyers should obtain the latest relevant information before placing orders and should verify that such information is current and complete. All semiconductor products (also referred to herein as "components") are sold subject to TI's terms and conditions of sale supplied at the time of order acknowledgment.

TI warrants performance of its components to the specifications applicable at the time of sale, in accordance with the warranty in TI's terms and conditions of sale of semiconductor products. Testing and other quality control techniques are used to the extent TI deems necessary to support this warranty. Except where mandated by applicable law, testing of all parameters of each component is not necessarily performed.

TI assumes no liability for applications assistance or the design of Buyers' products. Buyers are responsible for their products and applications using TI components. To minimize the risks associated with Buyers' products and applications, Buyers should provide adequate design and operating safeguards.

TI does not warrant or represent that any license, either express or implied, is granted under any patent right, copyright, mask work right, or other intellectual property right relating to any combination, machine, or process in which TI components or services are used. Information published by TI regarding third-party products or services does not constitute a license to use such products or services or a warranty or endorsement thereof. Use of such information may require a license from a third party under the patents or other intellectual property of the third party, or a license from TI under the patents or other intellectual property of TI.

Reproduction of significant portions of TI information in TI data books or data sheets is permissible only if reproduction is without alteration and is accompanied by all associated warranties, conditions, limitations, and notices. TI is not responsible or liable for such altered documentation. Information of third parties may be subject to additional restrictions.

Resale of TI components or services with statements different from or beyond the parameters stated by TI for that component or service voids all express and any implied warranties for the associated TI component or service and is an unfair and deceptive business practice. TI is not responsible or liable for any such statements.

Buyer acknowledges and agrees that it is solely responsible for compliance with all legal, regulatory and safety-related requirements concerning its products, and any use of TI components in its applications, notwithstanding any applications-related information or support that may be provided by TI. Buyer represents and agrees that it has all the necessary expertise to create and implement safeguards which anticipate dangerous consequences of failures, monitor failures and their consequences, lessen the likelihood of failures that might cause harm and take appropriate remedial actions. Buyer will fully indemnify TI and its representatives against any damages arising out of the use of any TI components in safety-critical applications.

In some cases, TI components may be promoted specifically to facilitate safety-related applications. With such components, TI's goal is to help enable customers to design and create their own end-product solutions that meet applicable functional safety standards and requirements. Nonetheless, such components are subject to these terms.

No TI components are authorized for use in FDA Class III (or similar life-critical medical equipment) unless authorized officers of the parties have executed a special agreement specifically governing such use.

Only those TI components which TI has specifically designated as military grade or "enhanced plastic" are designed and intended for use in military/aerospace applications or environments. Buyer acknowledges and agrees that any military or aerospace use of TI components which have **not** been so designated is solely at the Buyer's risk, and that Buyer is solely responsible for compliance with all legal and regulatory requirements in connection with such use.

TI has specifically designated certain components as meeting ISO/TS16949 requirements, mainly for automotive use. In any case of use of non-designated products, TI will not be responsible for any failure to meet ISO/TS16949.

### Products

Audio	<a href="http://www.ti.com/audio">www.ti.com/audio</a>
Amplifiers	<a href="http://amplifier.ti.com">amplifier.ti.com</a>
Data Converters	<a href="http://dataconverter.ti.com">dataconverter.ti.com</a>
DLP® Products	<a href="http://www.dlp.com">www.dlp.com</a>
DSP	<a href="http://dsp.ti.com">dsp.ti.com</a>
Clocks and Timers	<a href="http://www.ti.com/clocks">www.ti.com/clocks</a>
Interface	<a href="http://interface.ti.com">interface.ti.com</a>
Logic	<a href="http://logic.ti.com">logic.ti.com</a>
Power Mgmt	<a href="http://power.ti.com">power.ti.com</a>
Microcontrollers	<a href="http://microcontroller.ti.com">microcontroller.ti.com</a>
RFID	<a href="http://www.ti-rfid.com">www.ti-rfid.com</a>
OMAP Applications Processors	<a href="http://www.ti.com/omap">www.ti.com/omap</a>
Wireless Connectivity	<a href="http://www.ti.com/wirelessconnectivity">www.ti.com/wirelessconnectivity</a>

### Applications

Automotive and Transportation	<a href="http://www.ti.com/automotive">www.ti.com/automotive</a>
Communications and Telecom	<a href="http://www.ti.com/communications">www.ti.com/communications</a>
Computers and Peripherals	<a href="http://www.ti.com/computers">www.ti.com/computers</a>
Consumer Electronics	<a href="http://www.ti.com/consumer-apps">www.ti.com/consumer-apps</a>
Energy and Lighting	<a href="http://www.ti.com/energy">www.ti.com/energy</a>
Industrial	<a href="http://www.ti.com/industrial">www.ti.com/industrial</a>
Medical	<a href="http://www.ti.com/medical">www.ti.com/medical</a>
Security	<a href="http://www.ti.com/security">www.ti.com/security</a>
Space, Avionics and Defense	<a href="http://www.ti.com/space-avionics-defense">www.ti.com/space-avionics-defense</a>
Video and Imaging	<a href="http://www.ti.com/video">www.ti.com/video</a>

### TI E2E Community

[e2e.ti.com](http://e2e.ti.com)