



October 2015



Voltage Reference Applications







Interactive Selection Guide

Contents

- User Guide
- Introduction to Voltage References
- Voltage Reference Parameters
- Market Sectors Menu (Home)
 - Application Overviews and Selection Guides

User Guide

- View in presentation mode for interactive experience
- Use embedded hyperlinks throughout guide to navigate between:
 - Sector home pages
 - Corresponding XY part-selection charts
 - Design parameter information pages

To view...	Click on...
Market Sector Menu	
TI.com sector home page to view end equipment block diagrams	
Application-specific parameters: higher priority	
Application-specific parameters: lower priority	
Parts to consider	
Product page on ti.com	

Introduction to Voltage References

	Series References	Shunt References
Diagram		
Number of Terminals	At least 3	At least 2
Advantages	<ul style="list-style-type: none">• Significantly lower power dissipation• Generally higher precision• Lower dropout• Lower I_q	<ul style="list-style-type: none">• No limit on maximum V_{IN}• V_{REF} not changing over V_{IN}• Can be used to create negative or floating reference voltages• Inherent current sourcing and sinking

Common Vref Applications



OR



\geq 8 bits

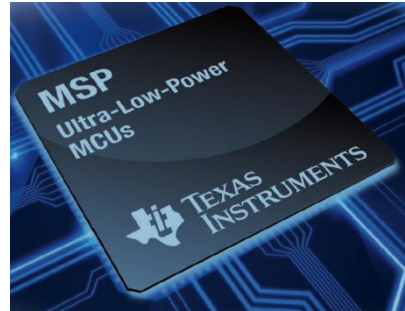

MCUs or ASICs
w/ integrated
Data Converter

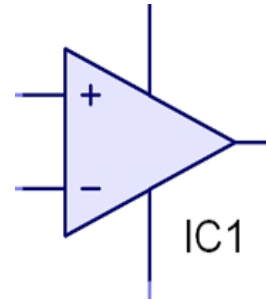

Comparators

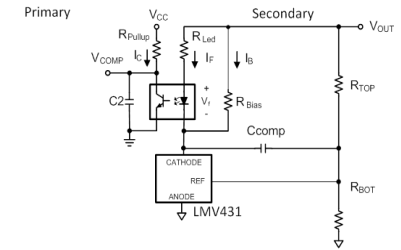

Flyback Opto-Isolator Circuit

Voltage Reference Parameters and Care-Abouts

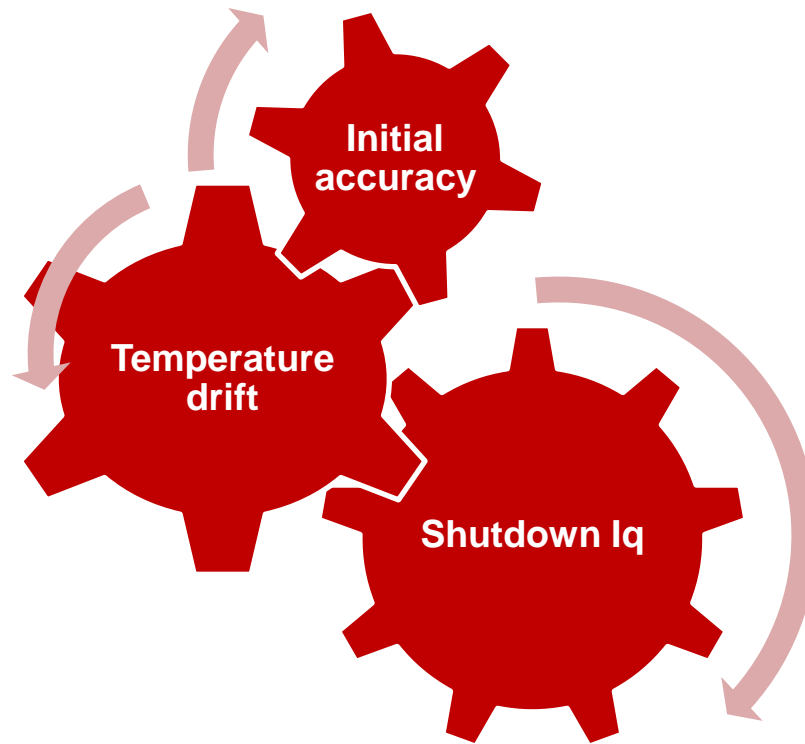

Initial Accuracy



- How close to stated nominal voltage the reference voltage is guaranteed to be at room temperature
- Typically specified as percentage between 0.01-2.0% (100-20,000 ppm)

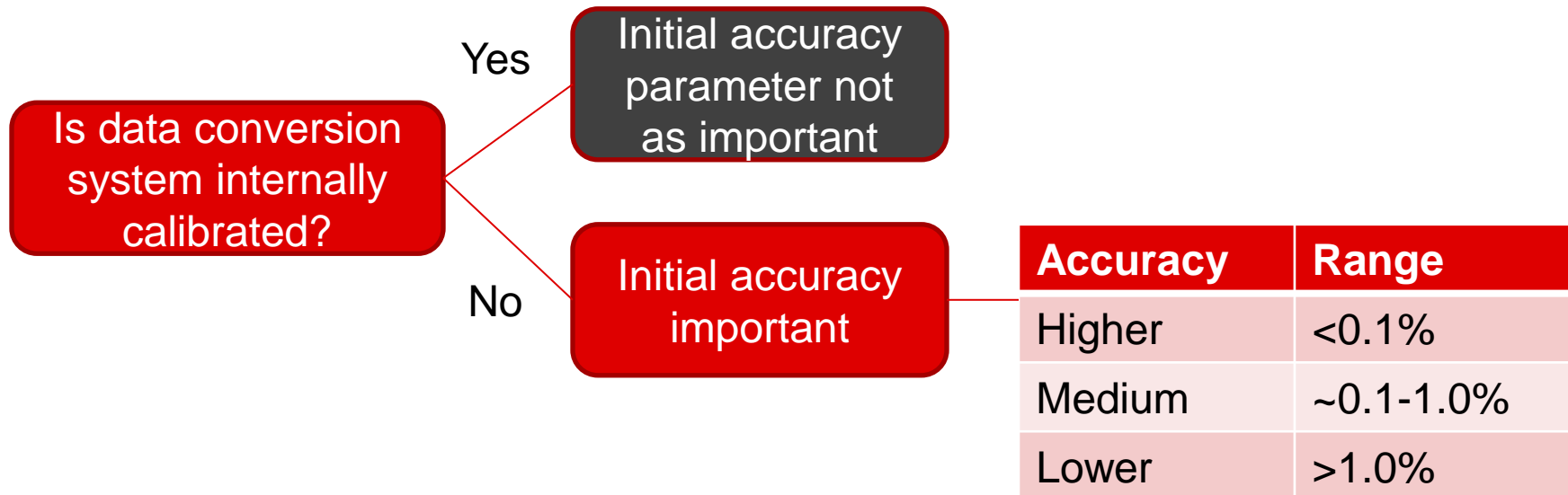

Return Menu							
Home	T&M	Factory Automation	Medical	Building Automation	Motor Drives	Space	Automotive

Temperature Coefficient/Drift (Tempco)



- Variation in V_{ref} over temperature
- Specified in ppm/°C or can be calculated using V_{dev} ($V_{max} - V_{min}$) specification

$$V_{ref} \left[\frac{ppm}{^{\circ}C} \right] = \pm \frac{(V_{max} - V_{min})}{V_{ref} (at 25^{\circ}C)} \times 10^6$$

(full temp range)

- Consider application's use case environment and practical user situations

Tempco	Est. range	Example applications
Very low	<10 ppm/C	Automotive, space/avionics/defense, building automation, factory automation, lab test equipment
Low	~10-50 ppm/C	Portable or hand-held equipment
Medium	~50-100 ppm/C	Portable or hand-held equipment
High	>100 ppm/C	Power supply

Return Menu

Home	T&M	Factory Automation	Medical	Building Automation	Motor Drives	Space	Automotive
----------------------	-------------------------	------------------------------------	-------------------------	-------------------------------------	------------------------------	-----------------------	----------------------------

Noise



- Internal noise (flicker noise $1/f$) of voltage reference IC causes error

Noise type	Frequency range	Typical specification	Easy to filter out?
Low-Frequency Noise (LFN)	0.1Hz – 10Hz	V_{p-p}	No
Wide-Band Noise (WBN; broadband noise)	10Hz – 1kHz	V_{rms}	Yes

- Applications such as medical and lab instrumentation require low noise ($<0.5\mu V_{p-p}$)
- Some series references (REF50xx) have additional trim/noise reduction pin to further adjust output voltage or create low-pass filter

Return Menu

Home	T&M	Factory Automation	Medical	Building Automation	Motor Drives	Space	Automotive
----------------------	-------------------------	------------------------------------	-------------------------	-------------------------------------	------------------------------	-----------------------	----------------------------

Stability Concerns



- **Long-Term Stability**

- Shift in V_{ref} after certain amount of continuous operation
- Typically expressed in PPM after 1000hrs
- Typically package dependent

- **Thermal Hysteresis**

- Shift in V_{ref} due to thermal cycles
- Typically expressed in PPM
- Typically dependent on package, material, IC layout

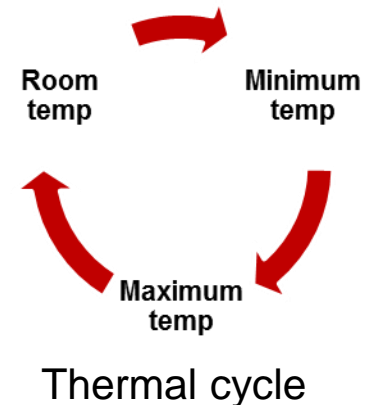

Return Menu

Home	T&M	Factory Automation	Medical	Building Automation	Motor Drives	Space	Automotive
----------------------	-------------------------	------------------------------------	-------------------------	-------------------------------------	------------------------------	-----------------------	----------------------------

Power Consumption



For the same performance, a series reference would consume less power than a shunt reference:

Shunt references	Series references
Designed for maximum (peak) current in system. If system does not need current, reference shunts this current towards ground.	Only draws current needed by system (plus current needed to operate reference). This results in lower average current consumption
	Some series references (LM41xx) have additional enable pin capability to shutdown reference when not in use
	Lower Iq results in lower average current consumption

Return Menu

Home	T&M	Factory Automation	Medical	Building Automation	Motor Drives	Space	Automotive
----------------------	-------------------------	------------------------------------	-------------------------	-------------------------------------	------------------------------	-----------------------	----------------------------

ADC Resolution



- External Vrefs are often used to achieve accurate data conversion measurements because internal ADC references may not offer the required precision
- ADC datasheets will specify voltage reference input (V_{REF} output) if external Vref option is supported

Resolution	Bits	Example applications
Higher	>16 bits	Lab-grade test instruments
Medium	12-16 bits	Precision instruments, factory automation, automotive, motor drives, medical instruments
Lower	<12 bits	Power supplies

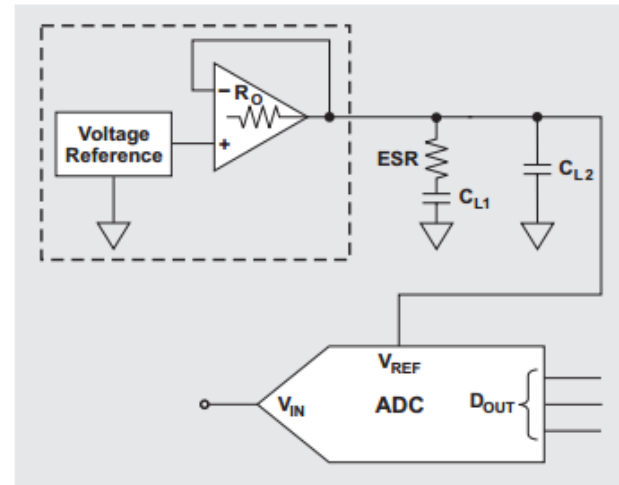

Example configuration of external Vref as input to ADC

Return Menu

[Home](#)

[T&M](#)

[Factory Automation](#)

[Medical](#)

[Building Automation](#)

[Motor Drives](#)

[Space](#)

[Automotive](#)



Market Sectors Menu

Resources



Test & Measurement



Building Automation



Factory Automation & Control



Motor Drives



Medical/Healthcare/
Fitness



Space/Avionics/
Defense



Automotive

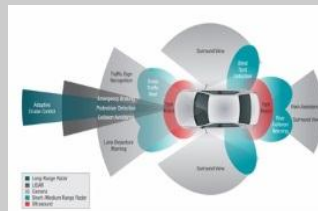

Test and Measurement



- Specific system care-aboutments will depend on type of test and measurement equipment
- For example, lab bench equipment will have higher emphasis on low temperature drift and long-term stability, while portable instruments will have higher emphasis on low power consumption



Lab Equipment



- System care-about

Initial acc
[HIGH]

ADC res
[MED-HIGH]

Power consumption

Temp drift
[LOW]

Noise
[LOW]

Long-term stability

- Example equipment

- Vector signal analyzer
- Spectrometer
- Wireless communications tester
- Bench digital multimeter
- Oscilloscope weigh scale
- Signal and waveform generator



Parts to consider

[Back to Test and Measurement](#)

[Portable Equipment](#)

References for Lab Equipment

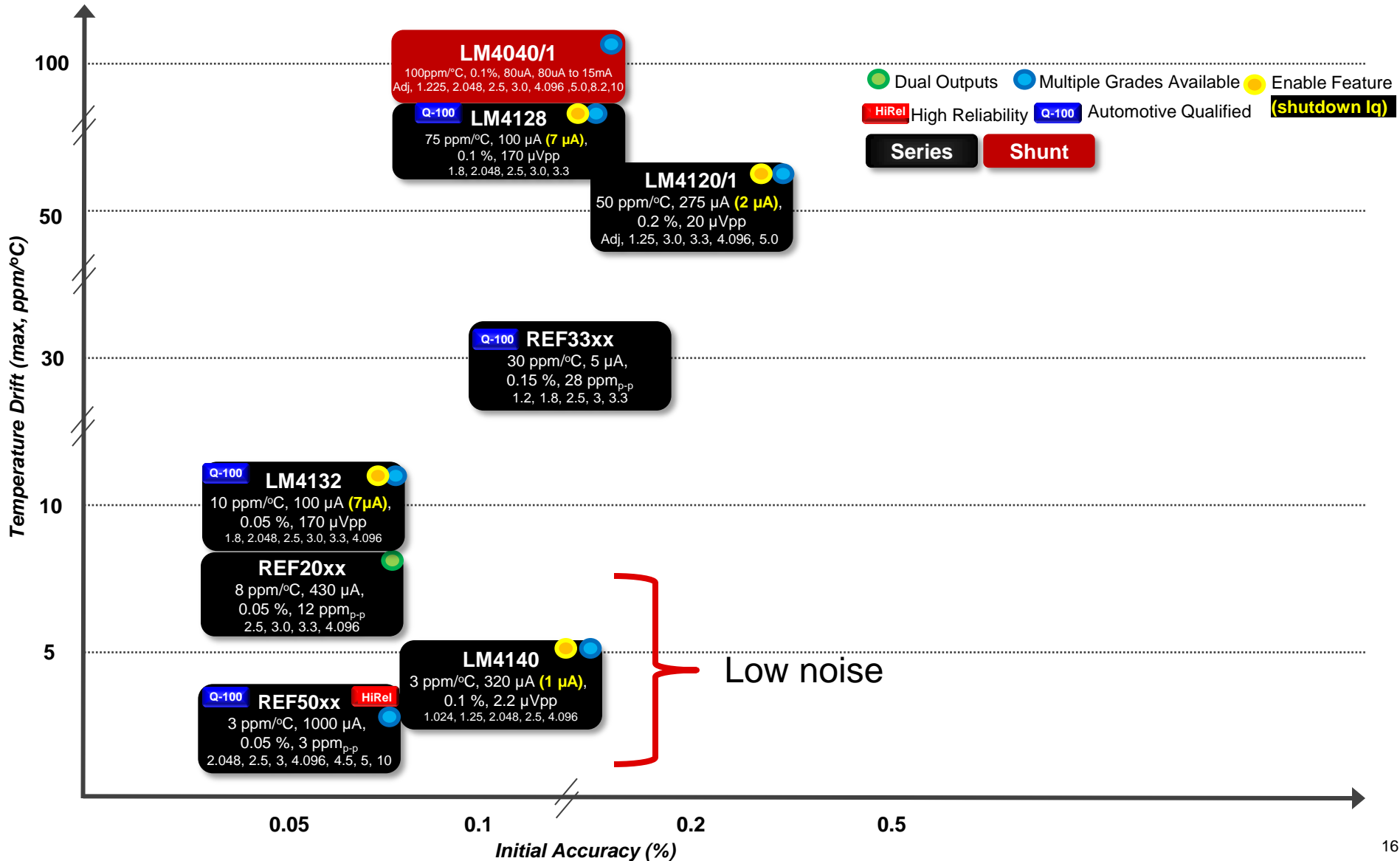

References for Portable Equipment

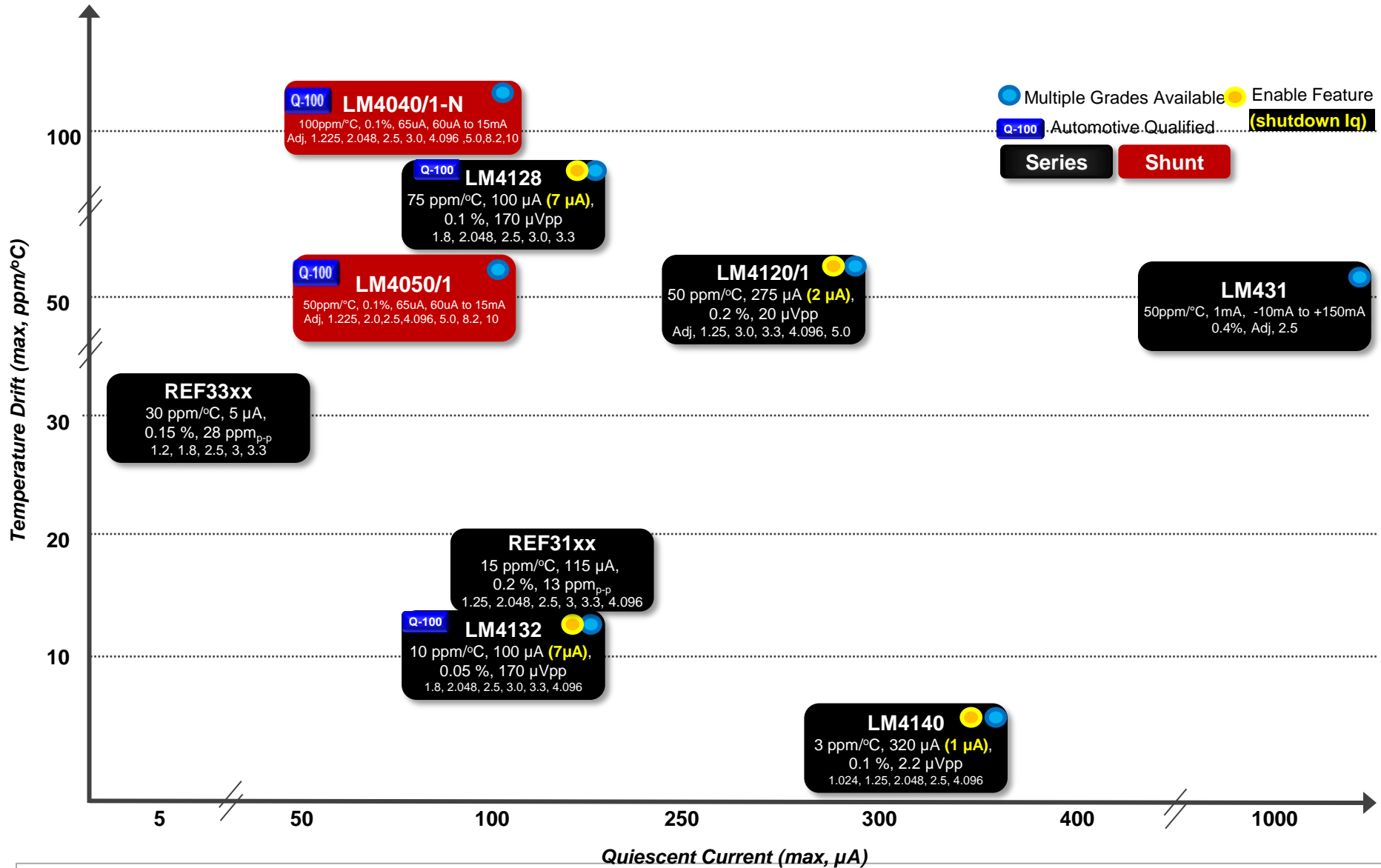

[Back to Portable Test Equipment](#)

Factory Automation & Control



- System care-about

Initial acc
[HIGH]

Power consumption
[LOW]

ADC res
[MED-HIGH]

Temp drift
[LOW]

Noise
[LOW]

Long-term stability

Examples of end equipment	Additional considerations
PLC: Analog I/O modules	Typ output voltages between 0-10V (consider adj Vout references); smaller packaging
PLC: Digital input modules	Typically have input voltages between 0-24V; need smaller packaging; consider shunt references for wide Vin requirements
Sensor transmitters	Low 1/f noise; low power consumption



Series to consider

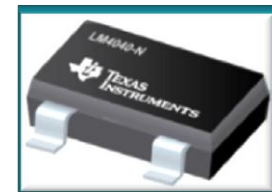

Shunts to consider



Shunt References for Factory Automation

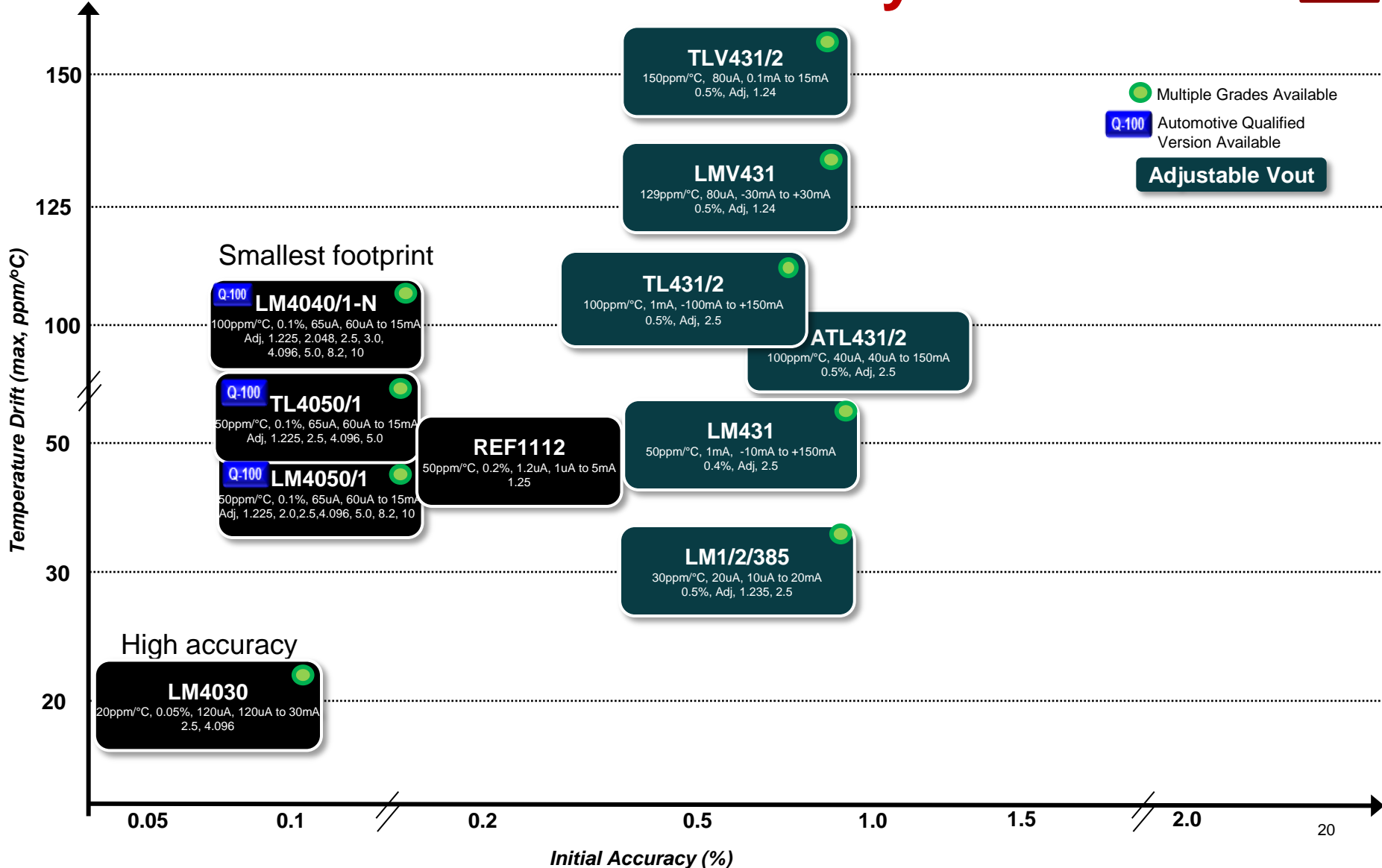

[Back to Factory Automation](#)

[Series References](#)

Series References for Factory Automation

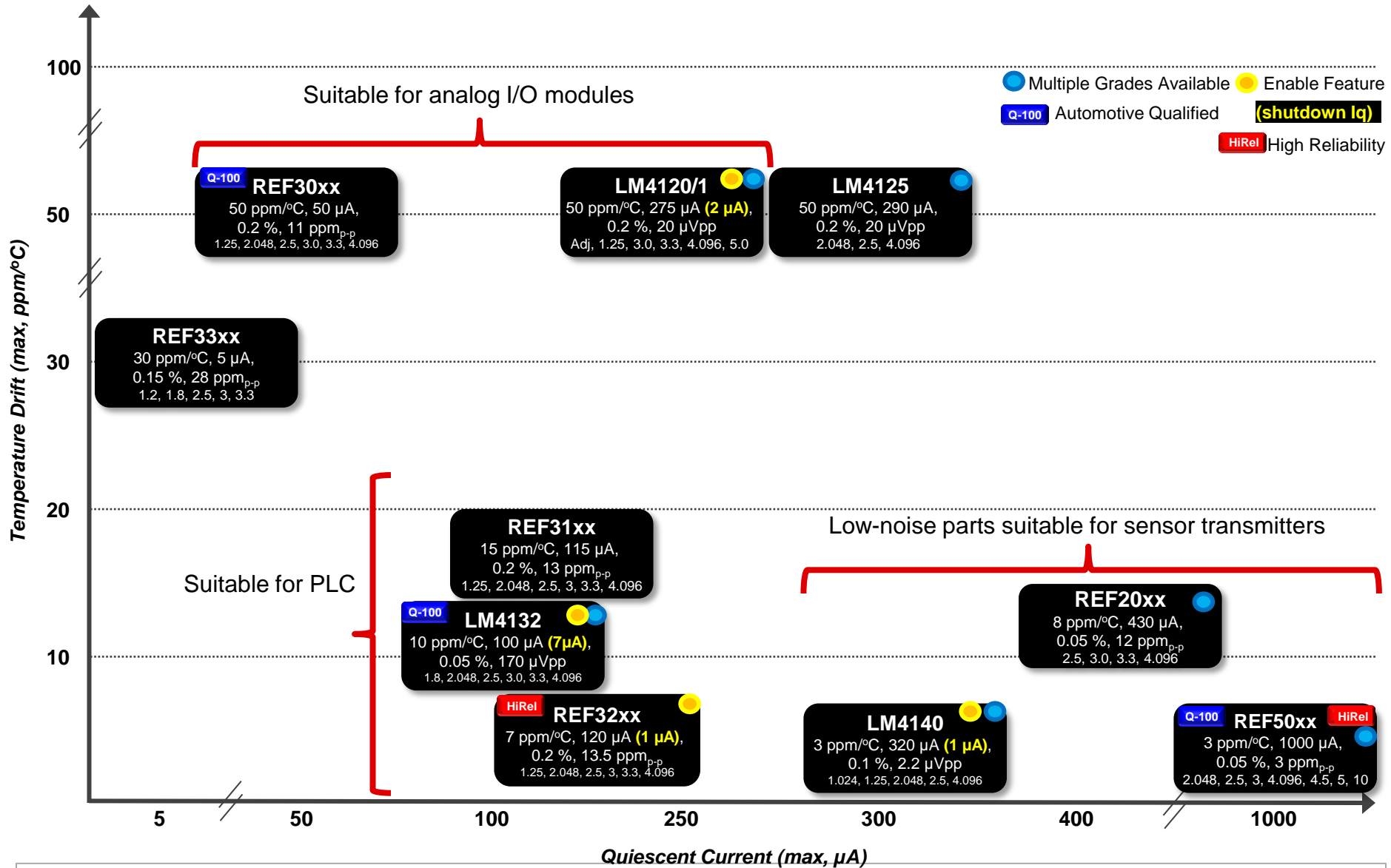

[Back to Factory Automation](#)

[Shunt References](#)

Medical Instrumentation



- System care-about

Initial accuracy
[MED-HIGH]

Power consumption
[LOW]

ADC res
[MED-HIGH]

Temp drift
[LOW]

Noise
[LOW]

Long-term stability

	Examples of end equipment	Additional considerations
Portable	Patient monitoring, pulse oximeter, blood glucose	Low power consumption; medium accuracy
Hospital/lab	CT scanner, ultrasound equipment	Low noise, high accuracy



Parts to consider

References for Medical Equipment

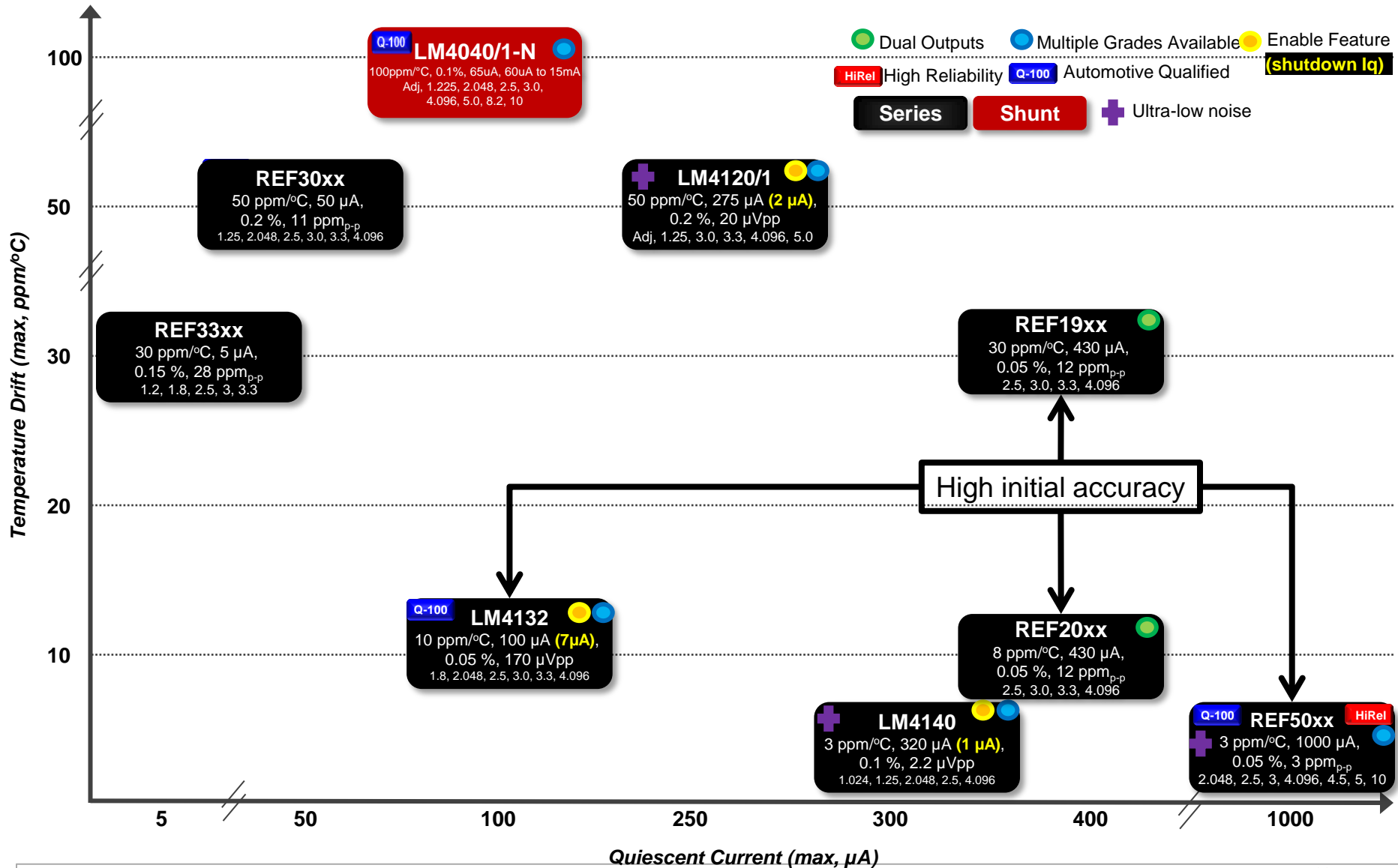

[Back to Medical Equipment](#)

Building Automation



- System care-about

Power consumption
[LOW]

Initial accuracy
[MED]

ADC res

Temp drift
[LOW]

Packaging
[SMALL]

Long-term stability

- Example applications

- Access control & security
- HVAC
- Video surveillance
- Elevators/escalators
- Building energy management



Parts to consider

References for Building Automation

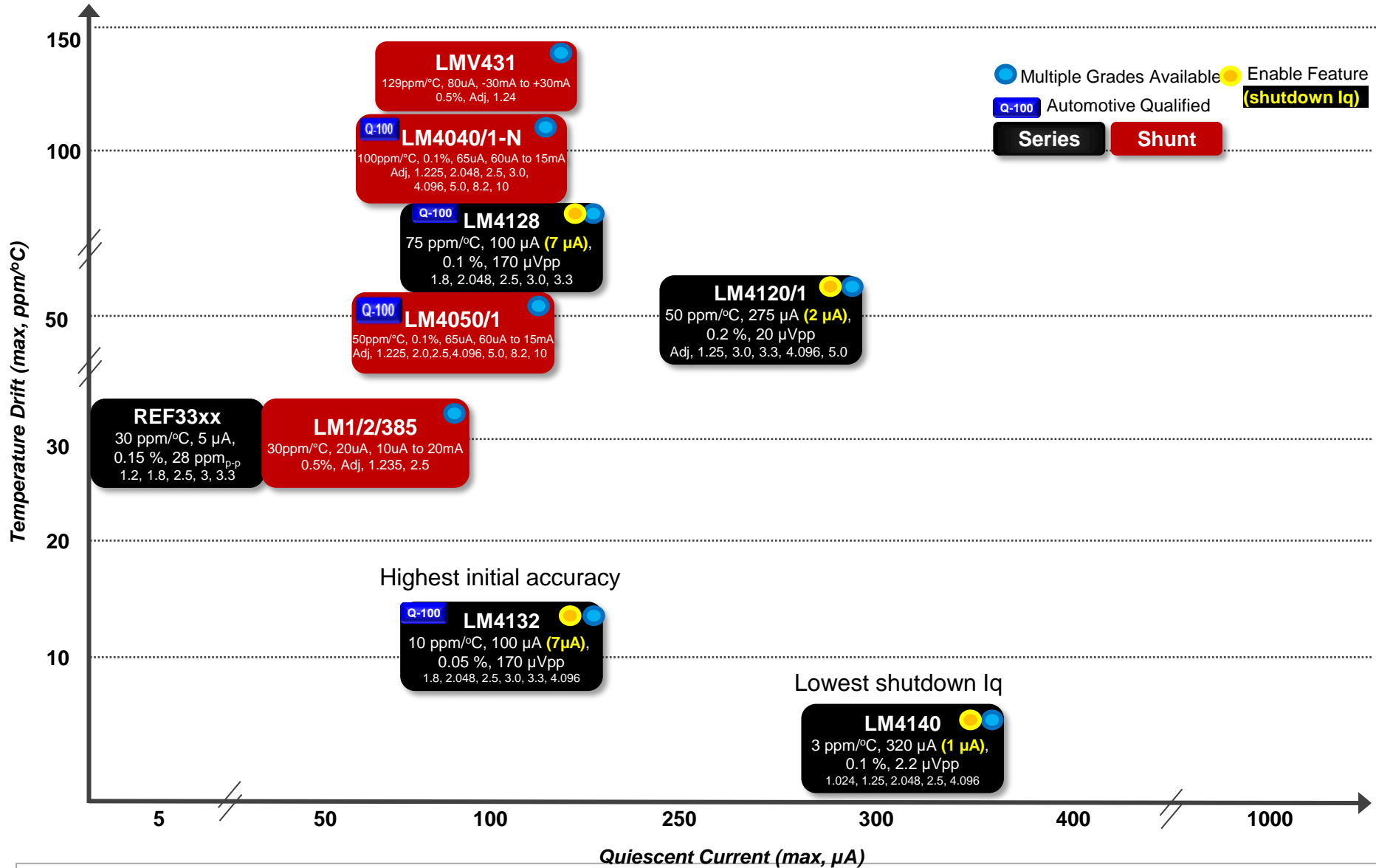

[Back to Building Automation](#)

Motor Drives



- System care-about

Power consumption
[LOW]

Initial accuracy
[MED-HIGH]

Packaging

Temp drift
[LOW]

ADC res
[MED]

Long-term stability

- Example equipment

- Programmable logic controllers
- Loop protection
- Stepper motor

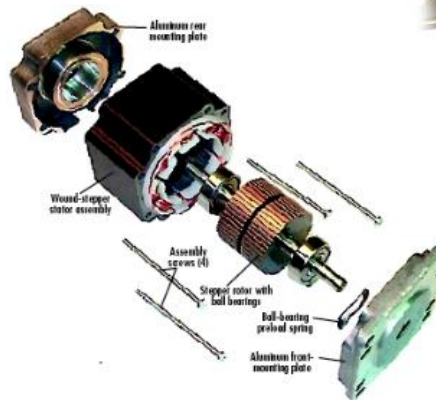

Parts to consider

References for Motor Drives

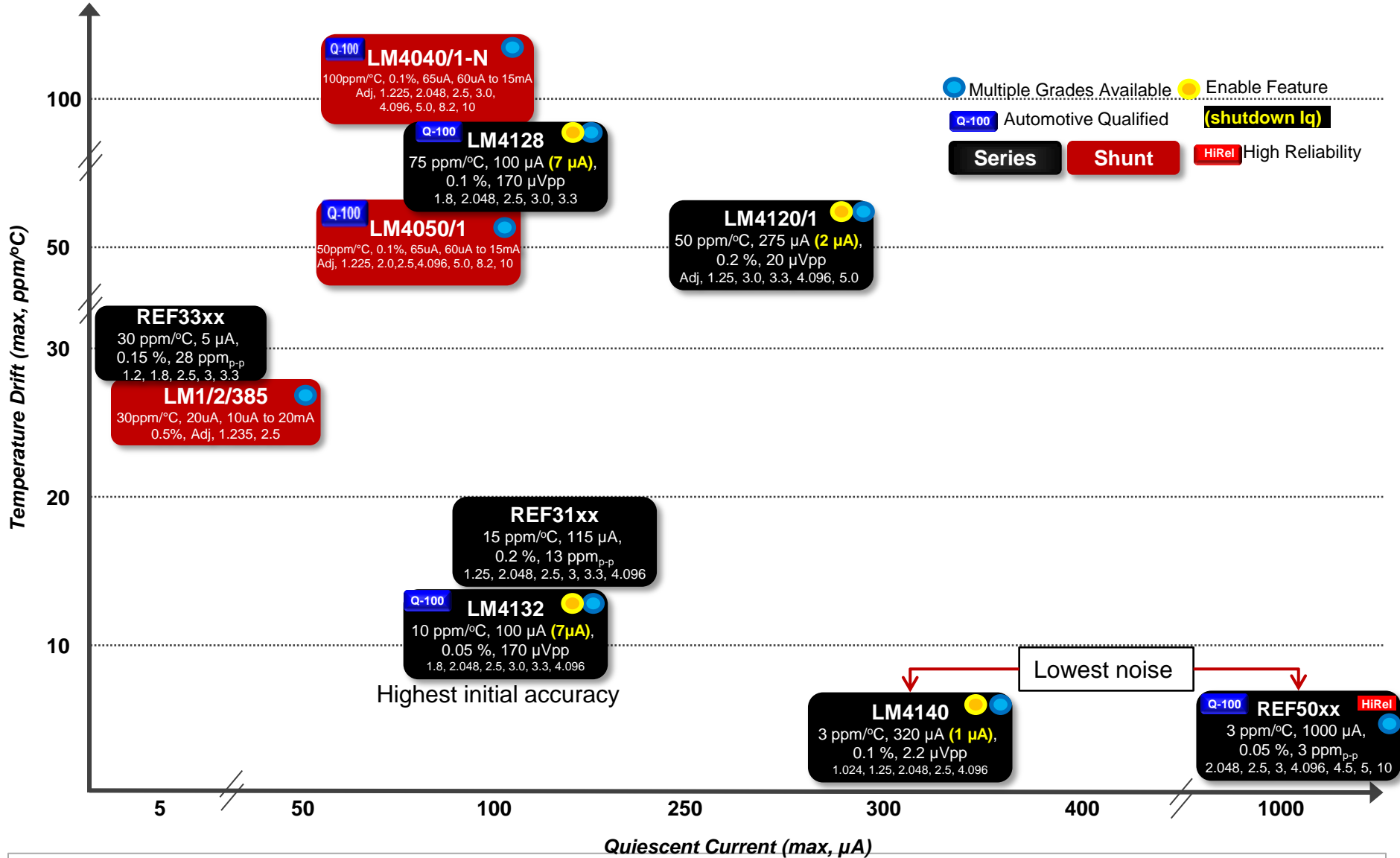

[Back to Motor Drives](#)

Space/Avionics/Defense



- System care-about

Noise
[LOW]

Power consumption
[LOW]

Packaging
[SMALL]

Temp drift
[LOW]

ADC res

Long-term stability

- Example equipment

- Aircraft
- Land defense
- Satellite payload sensors
- Military and avionics imaging
- Munitions targeting



Parts to consider



References for Space/Avionics/Defense

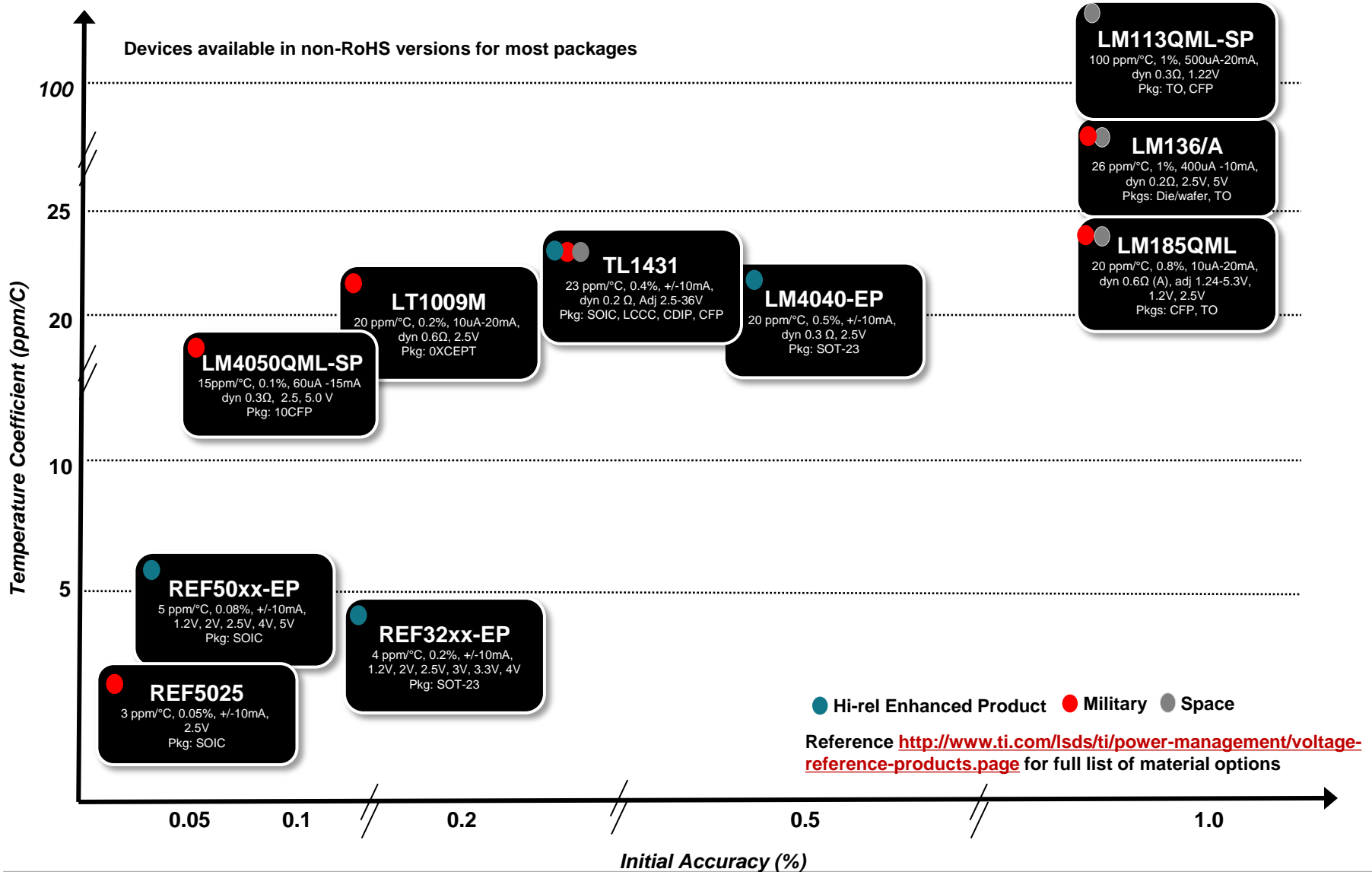

[Back to Space/Avionics/Defense](#)

Automotive

- System care-about

Wide Vin

Initial accuracy
[MED-HIGH]

Power consumption
[LOW]

Temp drift
[LOW]

Packaging
[SMALL]

Long-term stability
[HIGH]



XY Chart



Selection Grid



Application	Examples of end equipment	Considerations
ADAS	Camera modules (front, rear, surround), radar systems, ultrasonic park assist, LIDAR	Adjustable Vout, medium-high initial accuracy, small packaging
Infotainment/cluster	Instrument cluster and LCD displays, touchpad, telematics, USB hub/charger, audio system, head unit, MCU attach	Medium initial accuracy, small packaging
HEV/EV	Start-stop voltage conditioning, fuel pump and injection, emission control/sensors, steering, inverters, engine and battery management	Medium initial accuracy, battery life and monitoring
Body	LED headlamps/lighting, HVAC controls, door sensors/locking	Low power consumption
Passive safety	Braking system, airbags	Medium-high initial accuracy

AEC-Q100 References by Voltage & Accuracy

	Part number	Voltage options [V]									Initial accuracy grades [+/- %]				
											A	B	C	D	E
Shunt references	LM4040-N-Q1			2.5	3.0						0.1	0.2	0.5	1.0	2.0
	LM4041-N-Q1	1.2								Adj	0.1	0.2	0.5	1.0	2.0
	LM4050-N-Q1		2.048	2.5			4.1	5.0	8.192	10.0	0.1	0.2	0.5		
	TL431/2-Q1			2.5						Adj	1.0	0.5			
	TLVH431/2-Q1	1.2								Adj	1.0	0.5			
Series references	LM4128-Q1	1.8	2.048	2.5	3.0	3.3	4.1				0.1	0.2	0.5	1.0	
	LM4132-Q1			2.5	3.0						0.05	0.1	0.2	0.4	
	REF50xxA-Q1		2.048	2.5	3.0		4.096	4.5	5.0		0.05*	0.1**			

Notes

* high grade (REF50xx)

** standard grade (REF50xx)



References for Automotive

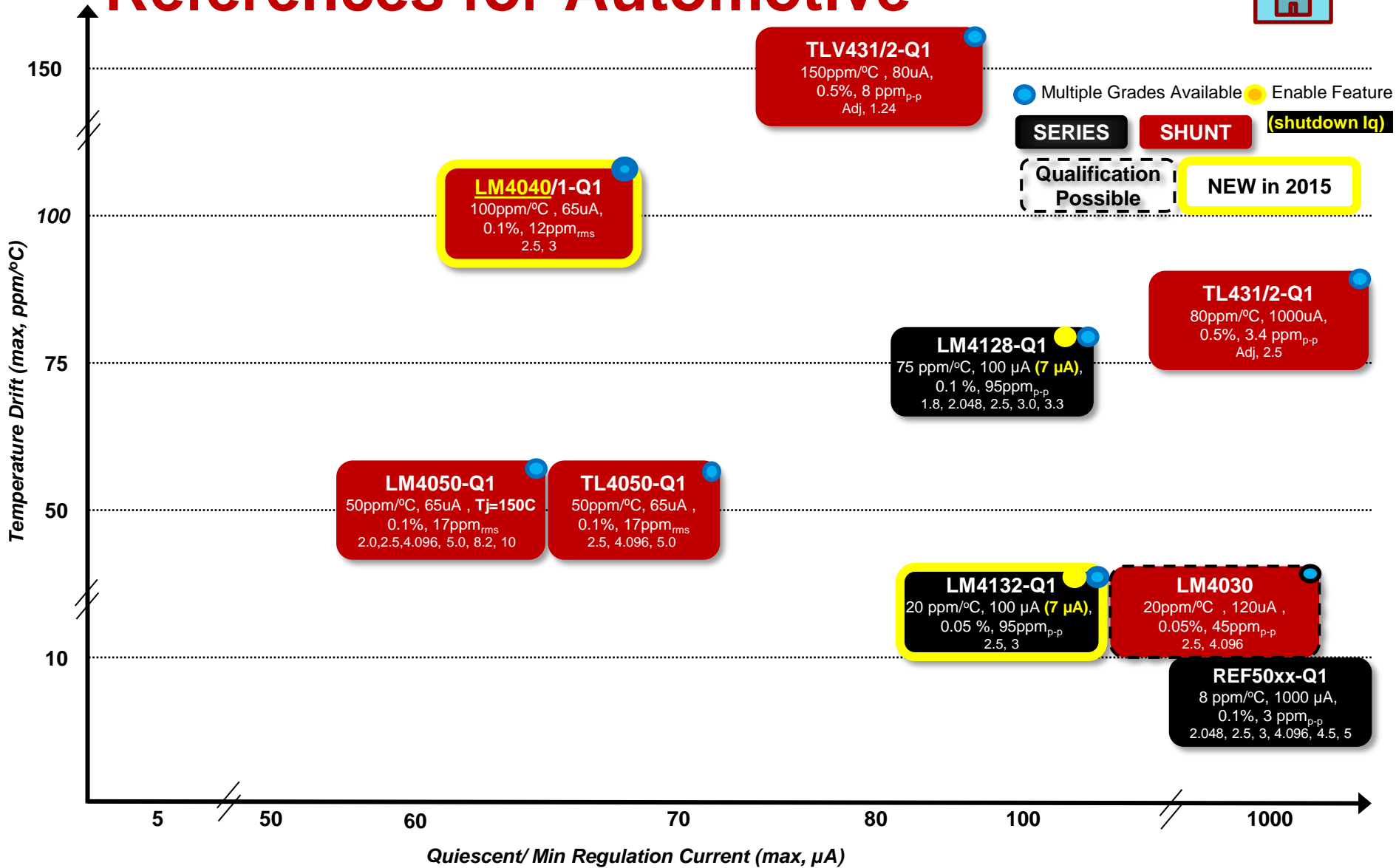

Packaging

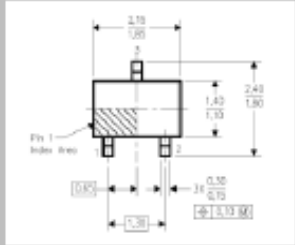

SC70

REF33xx (3)
LM4040 (5)
LM4041 (5)

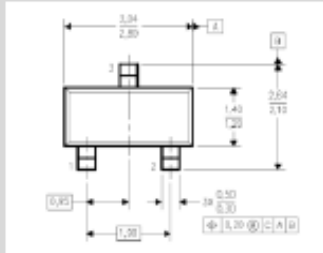

SOT23

REF30xx (3)
REF31xx (3)
REF32xx(6)
REF33xx (3)
LM4120 (5)
LM4121 (5)
LM4125 (5)
LM4128 (5)
LM4132 (5)
LM4030 (5)
LM4040 (3)
LM4041 (3)
LM4051 (3)
REF1112 (3)

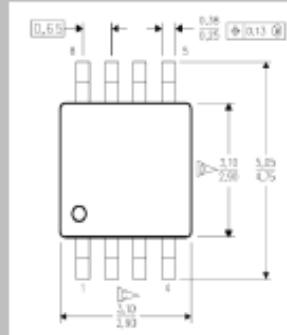

MSOP

REF50xx (8)

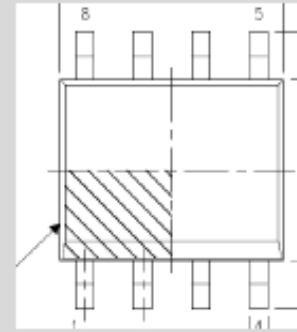

SOIC

REF50xx (8)
LM4140 (8)
LM185 (8)

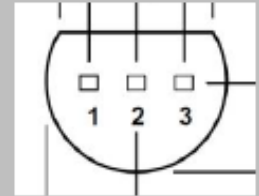

TO-92

LM4040
LM4041
LM185

Return Menu

[Home](#)

[T&M](#)

[Factory
Automation](#)

[Medical](#)

[Building
Automation](#)

[Motor Drives](#)

[Space](#)

[Automotive](#)

Voltage Reference Resources



Find it all on the Vref landing page: www.ti.com/vref

Learn

- [Voltage Reference Selection Basics](#) white paper
- [Shunt vs. Series: How to Select a Voltage Reference Topology](#) article
- Vref trick circuit blogs on [Precision Hub](#) and [Power House](#)

Design

- Vref [reference design library](#)
- [Webench ADC selector](#) for series Vrefs
- [Quick-start calculator](#) for shunt Vref external resistor

Select

- Interactive application-based [selection guides](#) (industrial and automotive)
- [Selection wheel](#) (online & paper, LIT#: SLYW017)
- [Vref overview brochure](#) (LIT#: SLPT030)
- [TI components for aerospace and defense](#) brochure (LIT#: SLYC143)

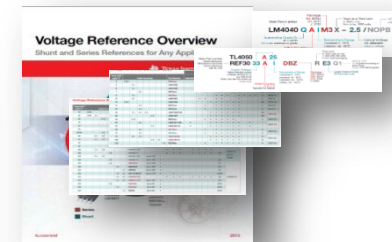
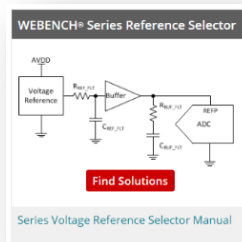
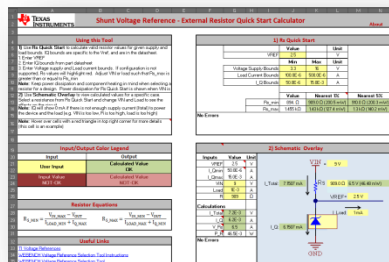

IMPORTANT NOTICE

Texas Instruments Incorporated and its subsidiaries (TI) reserve the right to make corrections, enhancements, improvements and other changes to its semiconductor products and services per JESD46, latest issue, and to discontinue any product or service per JESD48, latest issue. Buyers should obtain the latest relevant information before placing orders and should verify that such information is current and complete. All semiconductor products (also referred to herein as "components") are sold subject to TI's terms and conditions of sale supplied at the time of order acknowledgment.

TI warrants performance of its components to the specifications applicable at the time of sale, in accordance with the warranty in TI's terms and conditions of sale of semiconductor products. Testing and other quality control techniques are used to the extent TI deems necessary to support this warranty. Except where mandated by applicable law, testing of all parameters of each component is not necessarily performed.

TI assumes no liability for applications assistance or the design of Buyers' products. Buyers are responsible for their products and applications using TI components. To minimize the risks associated with Buyers' products and applications, Buyers should provide adequate design and operating safeguards.

TI does not warrant or represent that any license, either express or implied, is granted under any patent right, copyright, mask work right, or other intellectual property right relating to any combination, machine, or process in which TI components or services are used. Information published by TI regarding third-party products or services does not constitute a license to use such products or services or a warranty or endorsement thereof. Use of such information may require a license from a third party under the patents or other intellectual property of the third party, or a license from TI under the patents or other intellectual property of TI.

Reproduction of significant portions of TI information in TI data books or data sheets is permissible only if reproduction is without alteration and is accompanied by all associated warranties, conditions, limitations, and notices. TI is not responsible or liable for such altered documentation. Information of third parties may be subject to additional restrictions.

Resale of TI components or services with statements different from or beyond the parameters stated by TI for that component or service voids all express and any implied warranties for the associated TI component or service and is an unfair and deceptive business practice. TI is not responsible or liable for any such statements.

Buyer acknowledges and agrees that it is solely responsible for compliance with all legal, regulatory and safety-related requirements concerning its products, and any use of TI components in its applications, notwithstanding any applications-related information or support that may be provided by TI. Buyer represents and agrees that it has all the necessary expertise to create and implement safeguards which anticipate dangerous consequences of failures, monitor failures and their consequences, lessen the likelihood of failures that might cause harm and take appropriate remedial actions. Buyer will fully indemnify TI and its representatives against any damages arising out of the use of any TI components in safety-critical applications.

In some cases, TI components may be promoted specifically to facilitate safety-related applications. With such components, TI's goal is to help enable customers to design and create their own end-product solutions that meet applicable functional safety standards and requirements. Nonetheless, such components are subject to these terms.

No TI components are authorized for use in FDA Class III (or similar life-critical medical equipment) unless authorized officers of the parties have executed a special agreement specifically governing such use.

Only those TI components which TI has specifically designated as military grade or "enhanced plastic" are designed and intended for use in military/aerospace applications or environments. Buyer acknowledges and agrees that any military or aerospace use of TI components which have **not** been so designated is solely at the Buyer's risk, and that Buyer is solely responsible for compliance with all legal and regulatory requirements in connection with such use.

TI has specifically designated certain components as meeting ISO/TS16949 requirements, mainly for automotive use. In any case of use of non-designated products, TI will not be responsible for any failure to meet ISO/TS16949.

Products

Audio	www.ti.com/audio
Amplifiers	amplifier.ti.com
Data Converters	dataconverter.ti.com
DLP® Products	www.dlp.com
DSP	dsp.ti.com
Clocks and Timers	www.ti.com/clocks
Interface	interface.ti.com
Logic	logic.ti.com
Power Mgmt	power.ti.com
Microcontrollers	microcontroller.ti.com
RFID	www.ti-rfid.com
OMAP Applications Processors	www.ti.com/omap
Wireless Connectivity	www.ti.com/wirelessconnectivity

Applications

Automotive and Transportation	www.ti.com/automotive
Communications and Telecom	www.ti.com/communications
Computers and Peripherals	www.ti.com/computers
Consumer Electronics	www.ti.com/consumer-apps
Energy and Lighting	www.ti.com/energy
Industrial	www.ti.com/industrial
Medical	www.ti.com/medical
Security	www.ti.com/security
Space, Avionics and Defense	www.ti.com/space-avionics-defense
Video and Imaging	www.ti.com/video

TI E2E Community

e2e.ti.com