

EVM User's Guide: IWRL6432FSPEVM

IWRL6432FSPEVM Evaluation Module



Description

The IWRL6432FSP EVM is a form-factor optimized, easy-to-use, 60GHz mmWave sensor evaluation kit based on the IWRL6432 radar device with an onboard FR4-based antenna. This board enables proximity sensing and provides access to point-cloud data over a UART interface with a 3.3V power input. This kit is supported by mmWave tools, demos and software including the [MMWAVE-L-SDK](#) software development kit and the [RADAR-TOOLBOX](#).

Get Started

1. Order the [IWRL6432FSPEVM](#)
 - a. Kit includes EVM and breakout board (1.27mm to 2.54mm pitch converter board)
2. Download the latest libraries
 - a. [RADAR Toolbox](#)
 - b. [mmWave-L-SDK](#)
3. Download [PuTTY terminal](#)
4. Other materials needed for testing purposes
 - a. [USB to UART converter](#)
 - b. Micro-USB cable for PC connectivity
 - c. Header wires (female to female)

Features

- 57GHz to 64GHz mmWave sensor

- Antennas are designed to operate from 60GHz to 64GHz
- Three receive (RX) and two transmit (TX) antennas
- Wide Field of View (FoV):
 - 120° azimuth
 - 80° elevation
- FR408HR-based PCB substrate
- Cost-optimized PCB rules allow for lower manufacturing cost: no micro vias, only full stackup vias, and no via-in-pad
- On-board DC-DCs generate 1.8V and 1.2V rails for power optimized topology

Applications

- Industrial applications
 - [Automated door and gate, motion detector, occupancy detection \(people tracking, people counting\)](#)
 - [Video doorbell, IP network camera, thermostat](#)
 - [Air conditioner, refrigerators and freezers, vacuum robot](#)
 - [Lawn mower, home theater, PC or notebooks](#)
 - [Portable electronics, televisions, tablets, earphones, Smart watches, gaming, home theater and entertainment](#)
 - [Traffic intersection monitoring, gesture detection, proximity sensing](#)

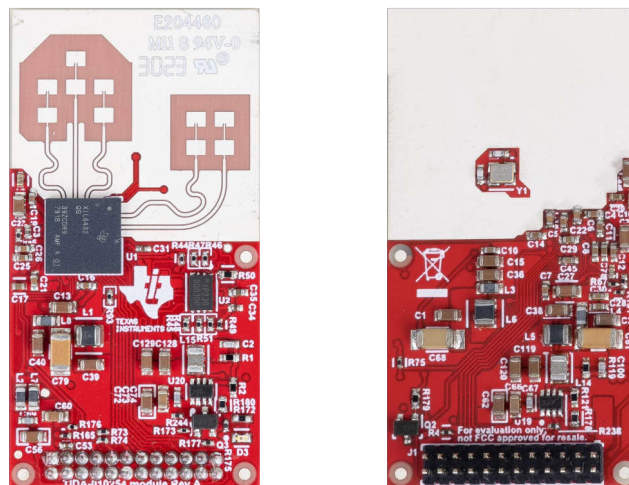

IWRL6432FSP EVM (Top View and Bottom View)

1 Evaluation Module Overview

1.1 Introduction

The IWRL6432FSP Evaluation Module (EVM) presents an easily navigable and cost-effective platform for assessing the capabilities of the IWRL6432 mmWave sensing device. Designed with an FR408HR-based PCB substrate, the board is optimized for a smaller form factor for space constrained end equipment and applications. With a focus on user-friendliness and versatility, the EVM can operate in stand alone mode and includes features that streamline the initiation of software development for on-chip hardware accelerators and low-power ARM® Cortex®-M4F processor.

Key attributes of this EVM include a wide-field-of-view antenna design, specifically crafted for wall and ceiling mounted sensing applications. A USB to UART interface provides point-cloud data and 3.3V power input. The inclusion of power-efficient discrete DC-DC regulators enhances overall energy efficiency.

Additionally, the EVM operates in a compact, low-power form, and incorporates a serial port for programming an on board 16 Mbit QSPI flash. This EVM stands as a comprehensive design for developers keen on exploring the potential of the IWRL6432 mmWave sensing device for battery-powered applications.

1.2 Kit Contents

IWRL6432FSP EVM kit includes the following:

- IWRL6432FSP evaluation board
- Breakout board
- Quick start guide

1.3 Specification

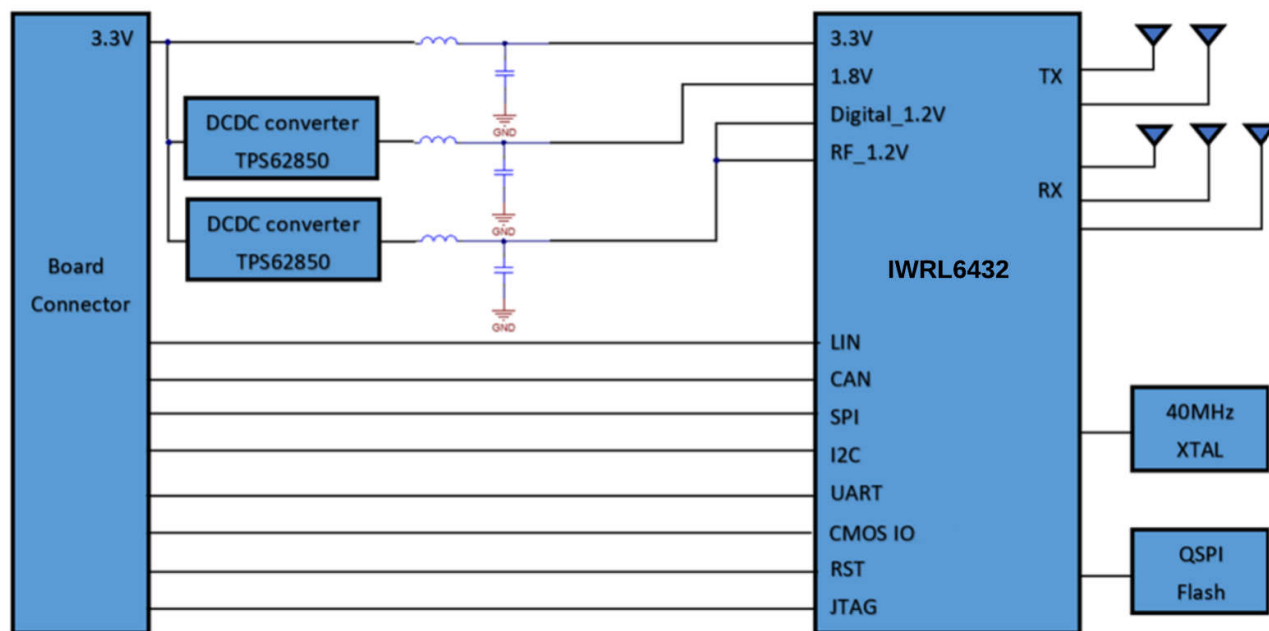

Figure 1-1. IWRL6432FSP EVM Block Diagram Design

Figure 1-1 shows the functional block diagram of the IWRL6432FSP EVM. The EVM contains the essential components for the TI mmWave radar system: TPS6285020ADRLR and TPS6285020MDRLR DC-DC converters for 1.2V and 1.8V power rails, QSPI Flash, SOP configuration, TI mmWave Radar chip, and a board connector for interfacing with [Section 3.1](#) or for powering the board in standalone mode.

1.4 Device Information

The IWRL6432 mmWave Sensor device is an integrated single chip mmWave sensor based on FMCW radar technology. The device is capable of operation in the 57GHz to 64GHz band and is partitioned into mainly four power domains:

- **RF and Analog Sub-System:** This block includes all the RF and Analog components required to transmit and receive the RF signals.
- **Front-End Controller Sub-System (FECSS):** FECSS contains ARM Cortex M3 processor, responsible for radar front-end configuration, control, and calibration.
- **Application Sub-System (APPSS):** APPSS is where the device implements a user programmable ARM Cortex M4 allowing for custom control and automotive interface applications. Top Sub-System (TOPSS) is part of the APPSS power domain and contains the clocking and power management sub-blocks.
- **Hardware Accelerator (HWA):** HWA block supplements the APPSS by offloading common radar processing such as FFT, Constant False Alarm rate (CFAR), scaling, and compression. IWRL6432 is specifically designed to have separate knobs for each of the above-mentioned power domains to control the states (power ON or OFF) based on use case requirements. The device also features the capability to exercise various low-power states like sleep and deep sleep, where low-power sleep mode is achieved by clock gating and by turning off some of the internal IP blocks of the device. The device also provides the option of keeping some contents of the device, like application image or RF profile retained in such scenarios. Additionally, the device is built with TI's low power 45-nm RF CMOS process and enables unprecedented levels of integration in an extremely small form factor. IWRL6432 is designed for low power, self-monitored, ultra-accurate radar systems in the industrial applications.

2 Hardware

2.1 PCB Storage and Handling Recommendations

This EVM contains components that can potentially be damaged by electrostatic discharge. Always transport and store the EVM in the supplied ESD bag when not in use. Handle using an antistatic wristband and operate on an antistatic work surface. For more information on proper handling, refer to SSYA010A.

PCB Storage and Handling Recommendations:

The immersion silver finish of the PCB provides better high-frequency performance compared to ENIG, but is also prone to oxidation in an open environment. This oxidation causes the surface around the antenna region to blacken. However, mmWave Radar performance remains intact. To avoid oxidation, the PCB needs to be stored in an ESD cover and kept at a controlled room temperature with low humidity conditions. All ESD precautions must be taken while using and handling the EVM.

2.2 Antenna

The IWRL6432FSP EVM antenna includes three receive and two transmit FR4 based antennas on the PCB. This has an antenna gain of approximately 5-6 dBi across each antenna. [Figure 2-1](#) shows the antenna configuration.

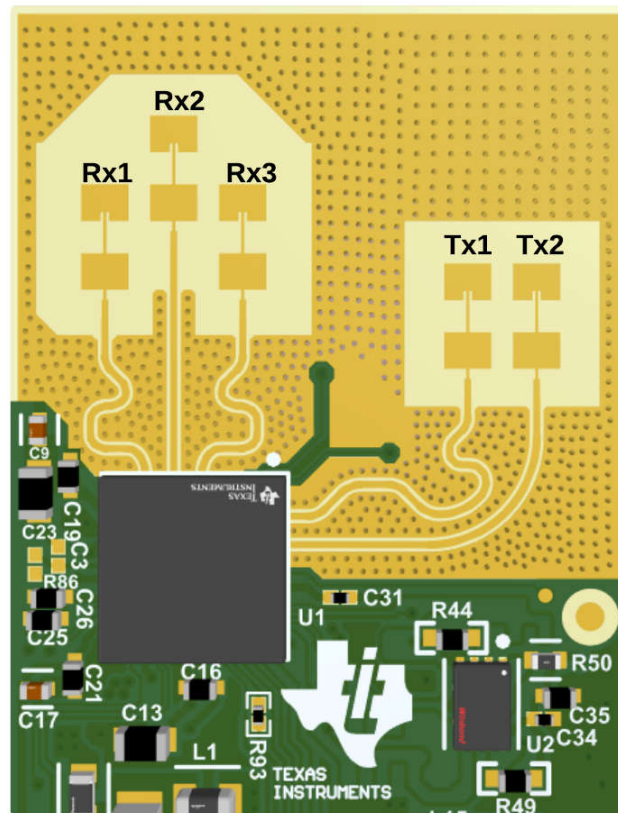

Figure 2-1. Receive (Rx) and Transmit (Tx) Antennas of the IWRL6432FSP EVM

PCB Material

The dielectric material used for the antenna and transmission lines is FR408HR 0.5 oz dual ply 2x1067 spread glass construction.

Layer	Copper_Usage(%)	Hole Structure	Material	Material Nominal Thickness(MIL)	Estimate Thickness(after pressing)(MIL)	Material Supplier
gts			Solder Mask	0.6	0.6	
L1(gtl)	70		Foil 0.5oz	1.378	1.378	
			Core 0.127 MM 1/0.5	5	5	ISOLA FR408HR
L2(l2s)	83		Foil 1oz	0.984	0.984	
			PP 2116	4.882	40.394	ISOLA FR408HR
			Core 0.79 MM			ISOLA FR408HR
			PP 2116			ISOLA FR408HR
L3(l3s)	71		Foil 1oz	0.984	0.984	
			Core 0.127 MM 1/0.5	5	5	ISOLA FR408HR
L4(gbl)	67		Foil 0.5oz	2.067	2.067	
gbs			Solder Mask	0.6	0.6	
Total Thickness:				59.016+/-5.906MIL	(solder mask to solder mask (including copper))	

Figure 2-2. IWRL6432FSP EVM PCB Material Stackup

Transmitter and Receiver Virtual Array

Transmitter and receiver antenna positions in [Figure 2-3](#) form a virtual array of six transmitter and receiver pairs. This allows object detections with finer azimuthal angular resolution (29°) and coarser elevational angular resolution (58°). Receiver antennas are spaced at distance D (λ/2) in the azimuthal plane and D (λ/2) in the elevation plane. Transmitter antenna Tx1 and Tx2 spaced at D (λ/2) in the azimuthal plane and are not spaced out in the elevation plane.

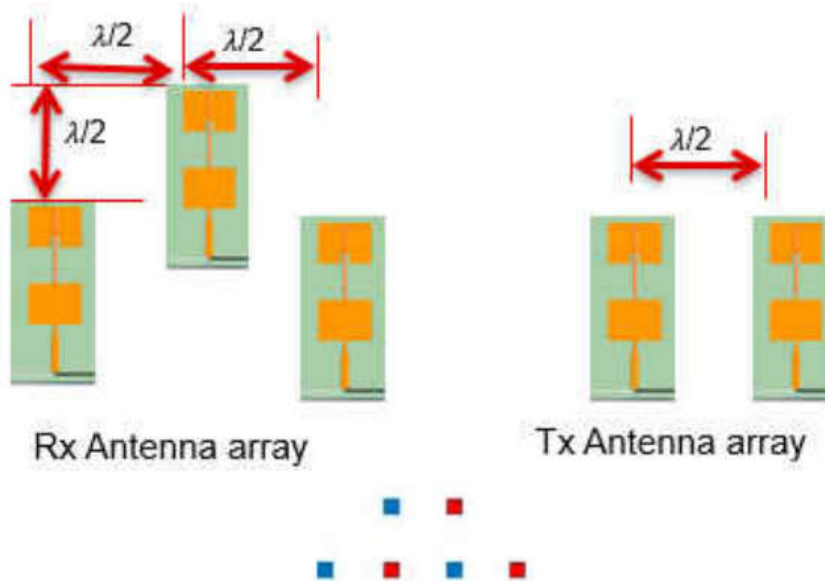

Figure 2-3. Virtual Antenna Array

[Figure 2-3](#) below shows the antenna radiation pattern with regard to azimuth and [Figure 2-4](#) shows the antenna radiation pattern with regard to elevation. Both figures show the radiation pattern for each TX-RX pair in the complete virtual array. This means that for the -6dB beamwidth, users need to look for a -12dB (Tx(-6dB) + Rx(-6dB)) beamwidth from boresight.

Note

Wavelength (λ) is computed based on a frequency of 62GHz. Antenna placements were designed according to this frequency.

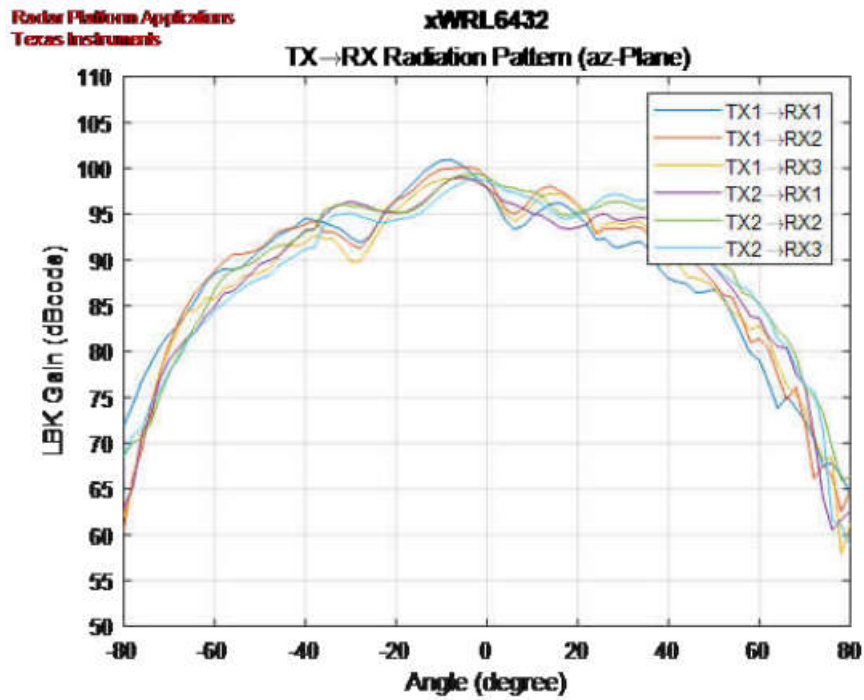

Figure 2-4. Azimuth Antenna Radiation Patterns

Measured azimuthal radiation pattern for all Tx-Rx pairs (corner reflector placed at approximately 5 meters with a 4GHz bandwidth chirp starting at 59GHz).

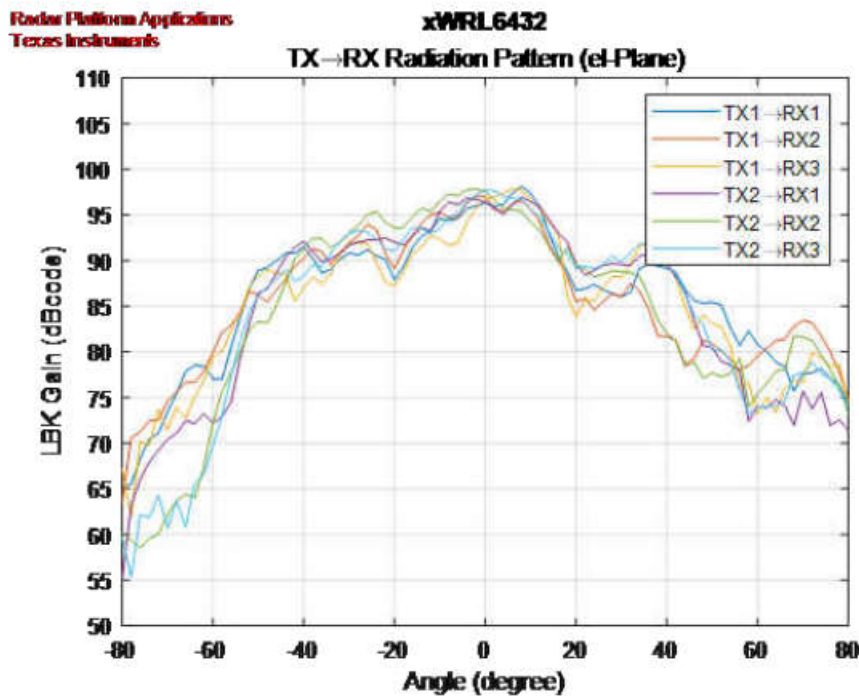

Figure 2-5. Elevation Antenna Radiation Patterns

Measured elevation radiation pattern for all Tx-Rx pairs (corner reflector placed at approximately 5 meters with a 4GHz bandwidth chirp starting at 59GHz).

CAUTION

In accordance to the EN 62311 RF exposure test, a minimum separation distance of 20 centimeters must be maintained between the user and the EVM during operation.

2.3 Setup

Table 2-1 lists the boot modes and the SOP settings.

Table 2-1. SOP Settings

	SOP0	SOP1
Flashing	0	0
Functional	1	0

The SOP mode is changed by grounding the SOP pin to indicate that the SOP mode is OFF or driving the SOP pin with 3.3V to indicate that this is ON. For flashing mode, both SOP0 and SOP1 pins are connected to ground. For functional mode, SOP0 is connected to 3.3V, and SOP1 is connected to ground. The SOP configuration can be seen in the pinout shown in Figure 2-6.

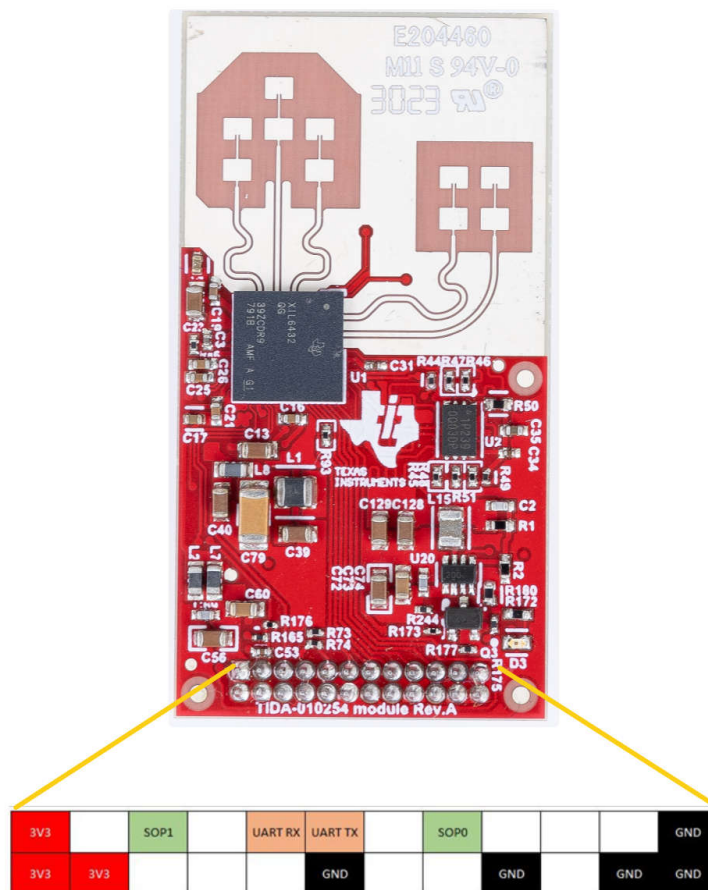

Figure 2-6. IWR6432FSP EVM Connector Pinout

For connecting to this EVM from a PC, a USB to UART converter can be used for accessing data and powering the board via USB. This converter is not provided with the kit and can be ordered separately. Ordering details for the USB to UART board can be found in Figure 2-6.

Connect IWRL6432FSP EVM to Breakout Board, USB to UART Adapter, and PC

Connect IWRL6432FSP EVM module to the breakout board provided in the kit.

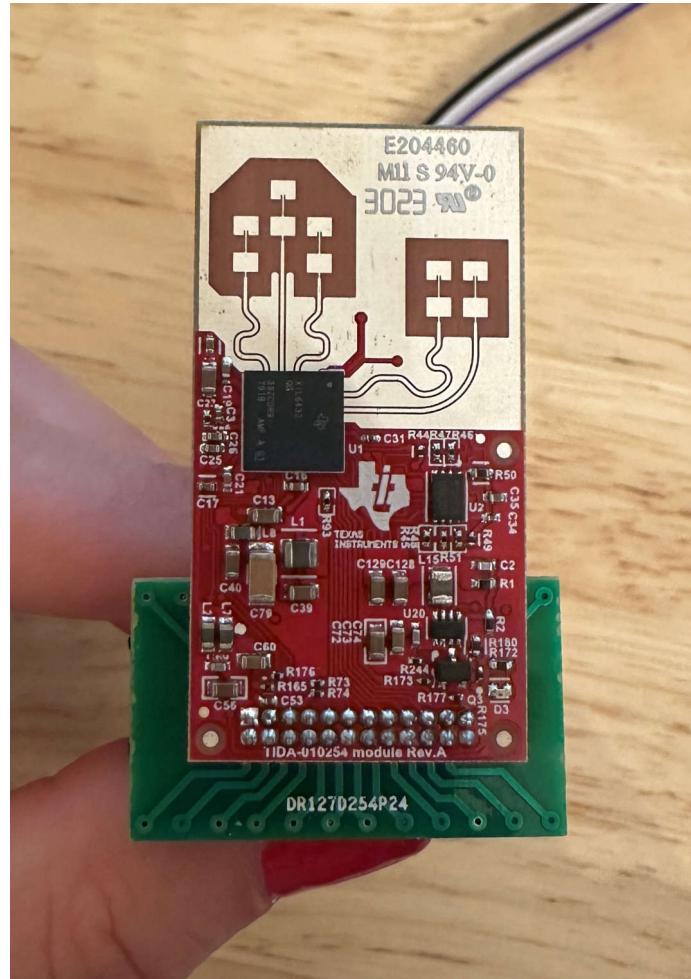

Figure 2-7. IWRL6432FSP EVM Connected to Breakout Board

Figure 2-7 includes a dual row, 1.27mm pitch, 24-pin, connector that allows for the EVM to be connected to 2.54mm pitch cables. These pins are used to connect the EVM to the USB to UART adapter board. The top row on the 1.27mm pitch connector corresponds to the top row on the 2.54mm pitch male connector, and the bottom row of the 1.27mm pitch connector corresponds to the bottom row on the 2.54mm pitch male connector.

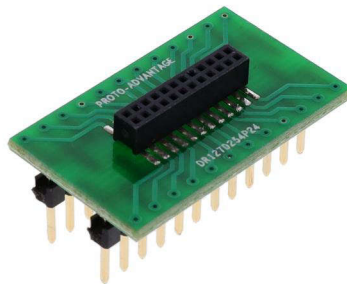

Figure 2-8. 1.27mm Pitch Converter Breakout Board

This breakout board allows for a connection between the module and USB to UART converter board. The USB to UART converter board uses the FTDI FT232RQ chip to provide an interface for the mmWave Radar board for data to be communicated via UART protocol. This data is transferred by USB interface and interpreted in the GUI. With this data, the GUI then displays a 2D or 3D representation of the objects being detected by the radar.

To use the USB to UART converter, a driver must be installed on the PC that connects to the board. This driver can be downloaded and installed at this link: [FTDI Chip](#). Download and install this driver prior to using the USB to UART converter.

To connect IWR6432FSP EVM module to the USB to UART converter, make sure the USB to UART adapter is on SYS3V3. This makes sure that the breakout board and module is powered directly by the USB to UART adapter rather than an external power source. This can be done by switching jumper JP1 to SYS (opposite to Figure 2-9).

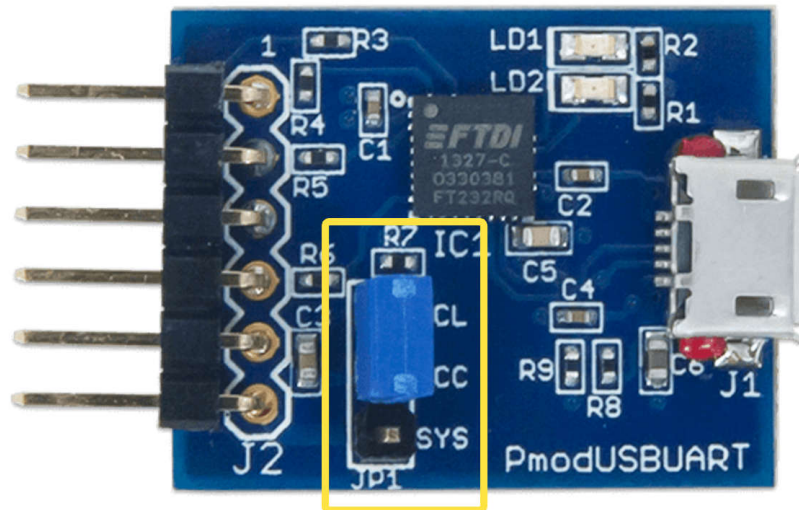

Figure 2-9. USB to UART Adapter Voltage Settings

Connect the following pins from the USB to UART adapter to the breakout board.

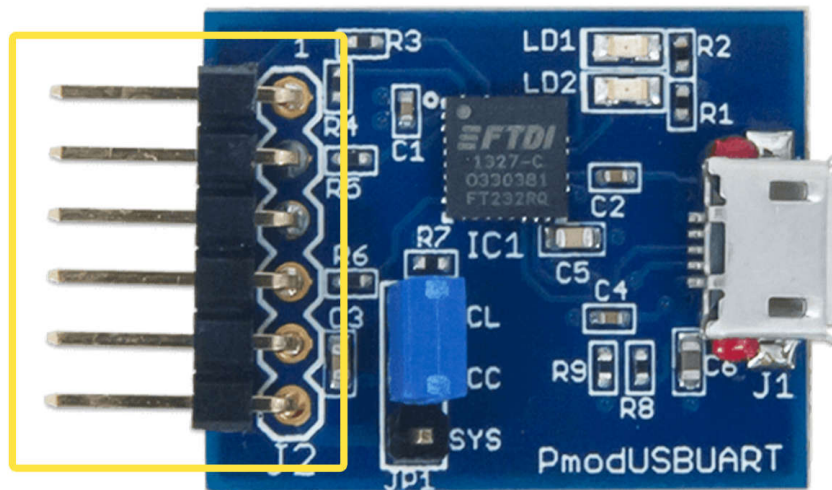

Figure 2-10. USB to UART Adapter Connector

The pins highlighted in [Figure 2-9](#) and [Figure 2-10](#) correspond to the following descriptions (refer to the [PmodUSBUART Reference Manual](#) for more information).

Table 2-2. USB to UART Adapter Pinout for EVM Connection

Pin	Signal	Description
1	RTS	Ready to Send
2	RXD	Receive
3	TXD	Transmit
4	CTS	Clear to Send
5	GND	Ground
6	SYS3V3	Power Supply (3.3V)

Using [Table 2-2](#) and [Figure 2-11](#), connect the following.

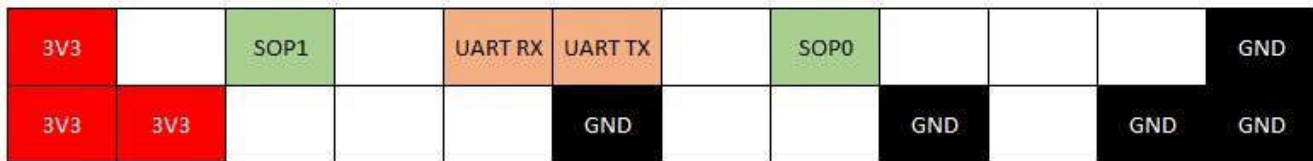

Figure 2-11. IWR6432FSPEVM Pinout for USB to UART Adapter Connection

1. Connect 3V3 pin on IWR6432FSP EVM to SYS3V3 power supply on USB to UART.
2. Connect GND pin on IWR6432FSP EVM to GND terminal on USB to UART.
3. Connect UART RX pin on IWR6432FSP EVM to TXD pin on USB to UART.
4. Connect UART TX pin on IWR6432FSP EVM to RXD pin on USB to UART.
5. Connect SOP1 pin on IWR6432FSP EVM to GND pin on IWR6432FSP EVM.
6. Connect SOP0 pin on IWR6432FSP EVM to GND for flashing mode, or connect to 3V3 pin on IWR6432FSP EVM for functional mode.

Once the setup discussed above is complete, connect USB to UART converter to PC via micro USB cable. The setup is shown in [Figure 2-12](#) and [Figure 2-13](#).

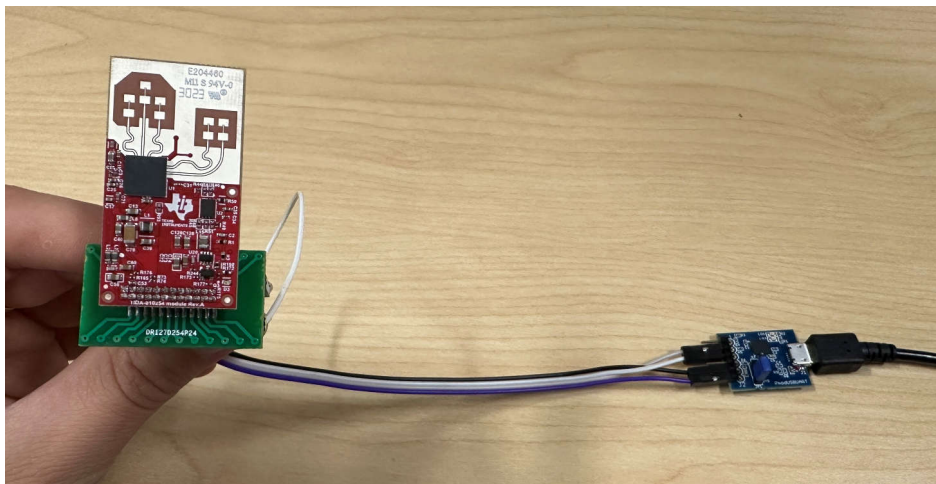

Figure 2-12. IWR6432FSP EVM Setup (Top View)

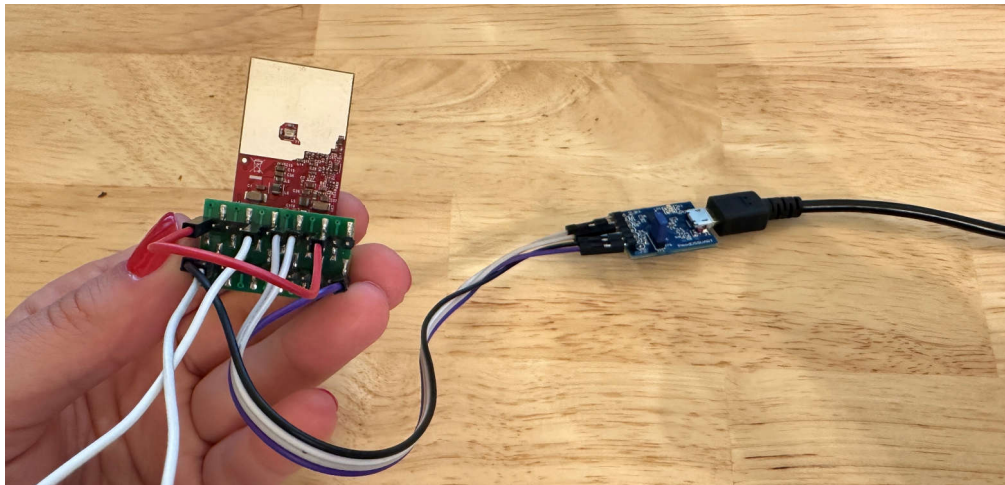

Figure 2-13. IWR6432FSP EVM Setup (Bottom View)

Table 2-3 contains the list of LEDs on the IWR6432FSPEVM.

Table 2-3. LED Settings

LED Reference Designators	Description
D3	3.3V power indication

Note

The default setting of the D3 LED is programmed to be OFF, done deliberately for low power consumption.

3 Software

Flash IWRL6432FSPEVM

1. Make sure all connections are set (IWRL6432FSPEVM module, breakout board, USB to UART adapter, micro USB cable to PC) as discussed in [Section 2.3](#).
2. Open the mmWave-L-SDK from [Section Get Started](#).
3. Set the device into *Flashing Mode* (SOP1 connected to GND, SOP0 connected to GND). Make sure that the board is power cycled after the board is switched from *Flashing* mode to *Functional* mode or vice versa.
4. Open `MMWAVE_L_SDK_XX_XX_XX_XX\tools\visualizer\visualizer.exe` and select *Flash* in the left column.
5. Select the correct COM port that the device is connected to (can be found in device manager).
6. In the *Device Select* section, select XWRL6432. Click *NEXT*.
7. In the *Board Switch Settings* section, select *SWITCH SETTINGS CONFIRMED*.
8. In the *Image flash* section, select *Custom image*, then click *upload*, and upload `MMWAVE_L_SDK_XX_XX_XX_XX\examples\mmw_demo\motion_and_presence_detection\prebuilt_binaries\iwrL64xx\motion_and_presence_detection_demo.release.appimage`.
9. Click “Flash”.

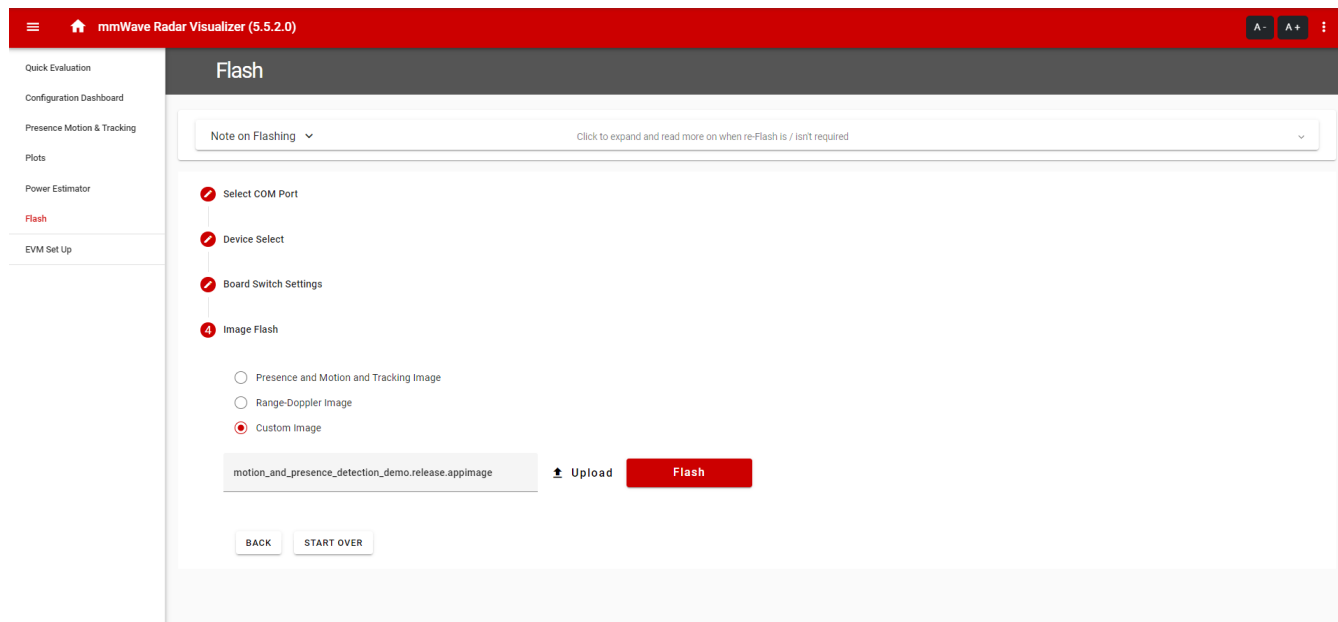

Figure 3-1. Flashing IWRL6432 Using mmWave Radar Visualizer

Check if Flashing is Successful

1. Set the device into *Functional Mode* (SOP0=1, SOP1=0). Make sure to power cycle the boards whenever switching between SOP modes.
2. Open PuTTY.
3. Select *Serial* connection type.
4. Input COM port in serial line.
5. Input 115200 speed.

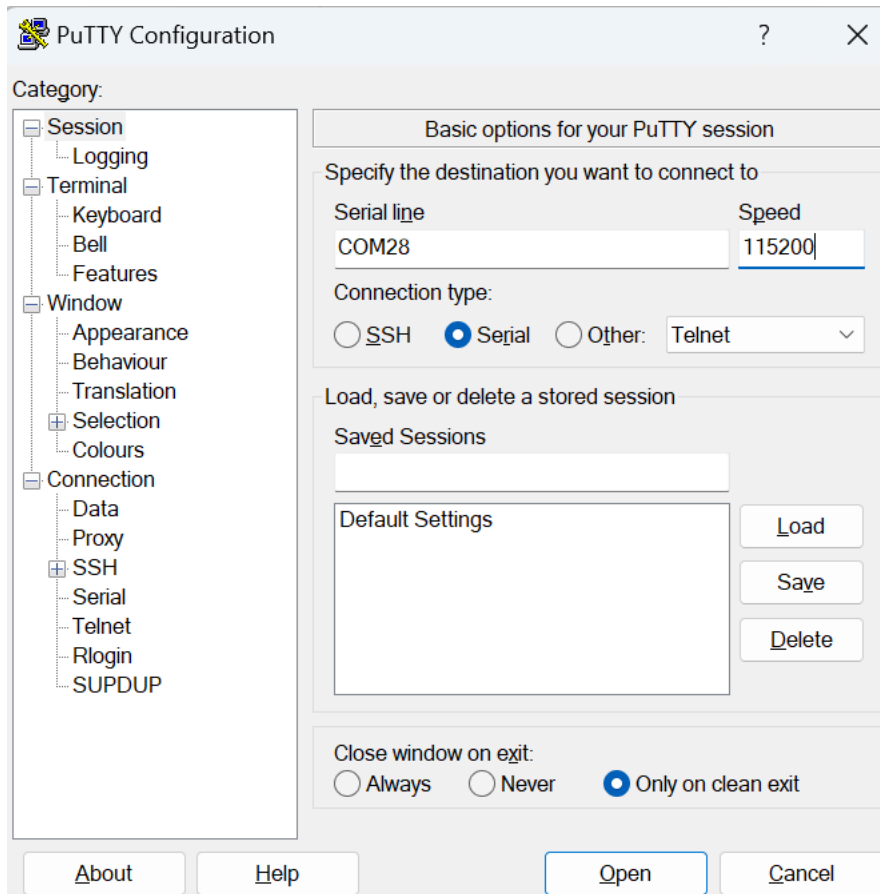

Figure 3-2. PuTTY Configuration for Connection Confirmation

6. Click *Open*.
7. When the console opens up, click *Enter*, and the output is similar to [Figure 3-3](#).

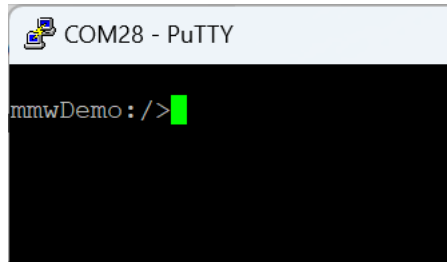
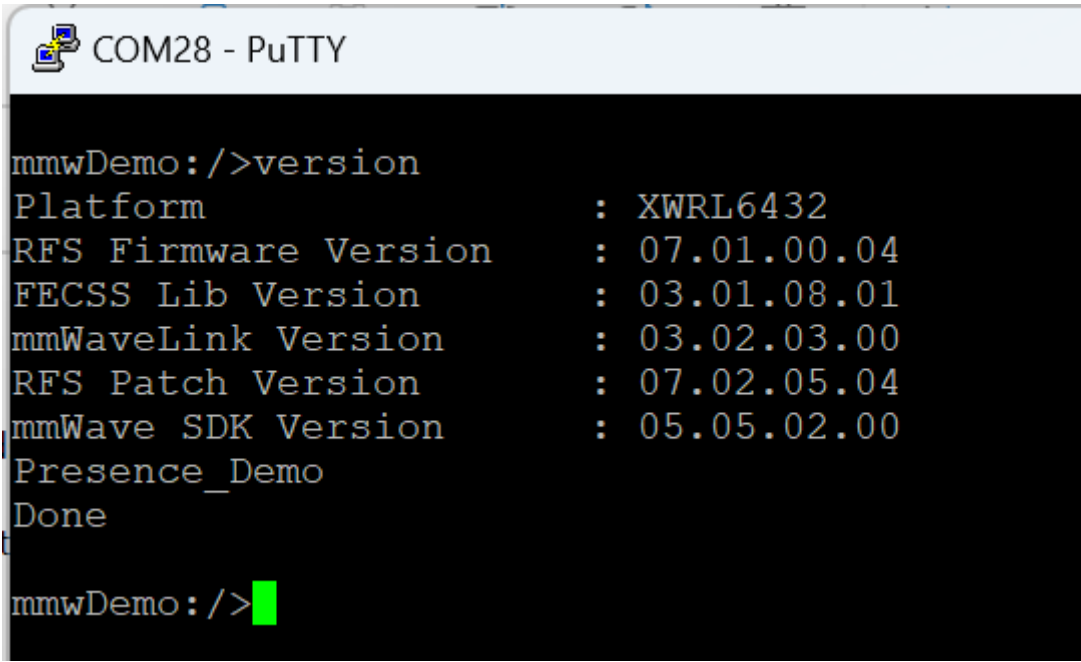

Figure 3-3. PuTTY Console with mmWave Demo Flashed

8. Type *version* and click *Enter*. Check if the module returns the version data in [Figure 3-4](#).



```
COM28 - PuTTY

mmwDemo: />version
Platform           : XWRL6432
RFS Firmware Version : 07.01.00.04
FECSS Lib Version   : 03.01.08.01
mmWaveLink Version  : 03.02.03.00
RFS Patch Version   : 07.02.05.04
mmWave SDK Version  : 05.05.02.00
Presence_Demo
Done

mmwDemo: />
```

Figure 3-4. PuTTY Console with mmWave Demo Version Identified

9. Connection is set, close PuTTY.

Running mmWave Visualizer GUI for mmWave Demo

After flashing the IWRL6432FSPEVM, as shown in [Flash IWRL6432FSPEVM](#), the *Plots* section in the mmWave visualizer can be used to display range plot via radar point cloud information.

1. Make sure all connections are set (IWRL6432FSP EVM, breakout board, USB to UART adapter, micro USB cable to PC) as discussed in [Section 2.3](#).
2. Make sure that switch settings are set to *Functional Mode* (SOP0=1, SOP1=0). Again, make sure users power cycle the boards whenever switching between SOP modes.
3. Open `MMWAVE_L_SDK_XX_XX_XX_XX\tools\visualizer` and select *Configuration Dashboard* in the left column.
4. In the *Device Connection* section, enter the COM Port (can be found in the device manager), Baud rate (115200), and device (XWRL6432).
5. In the *Configuration Selection* section, select *High Performance Motion Detection* for the *Select Preset Configuration* section.
6. Click *Send Config to Device*.

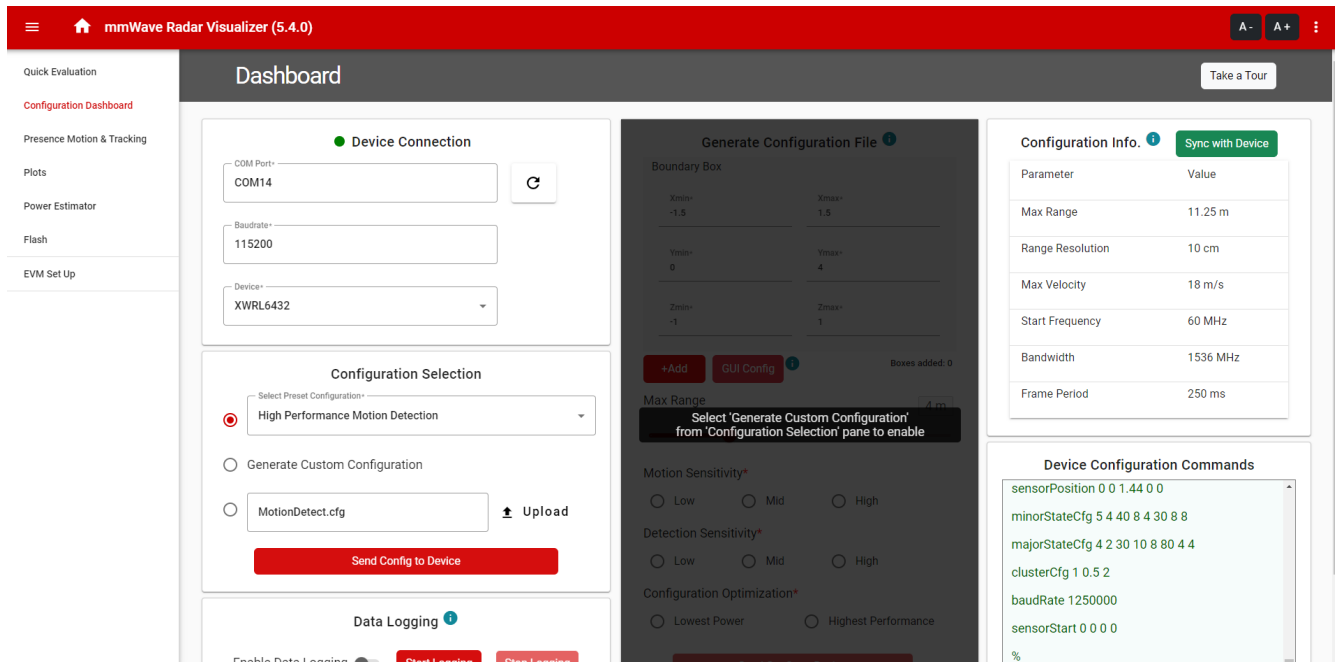

Figure 3-5. MmWave Radar Visualizer Configuration Inputs

7. The *Plots* section needs to then create plots for the Range Profile, X-Y Plot, Y-Z Plot, and X axis.

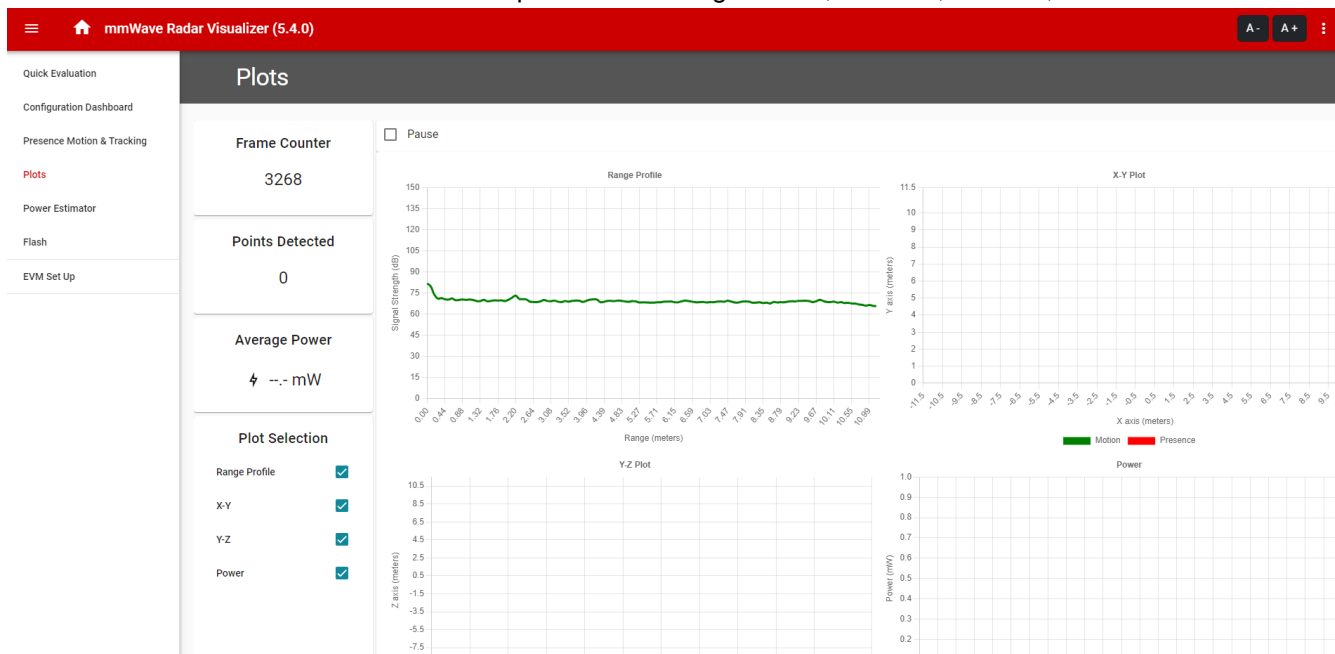

Figure 3-6. MmWave Radar Visualizer Plots

8. Make sure to power cycle the board between each configuration that is sent.
9. As an example of uploading a local config file, repeat steps 1-4 above, and select the last option in *Configuration Selection*. Then click *Upload* and upload the *MotionDetect.cfg* file that can be found through `MMWAVE_L_SDK_XX_XX_XX_XX\examples\mmw_demo\motion_and_presence_detection\profiles\xwrl64xx-evm`. Click *Send Config to Device*.

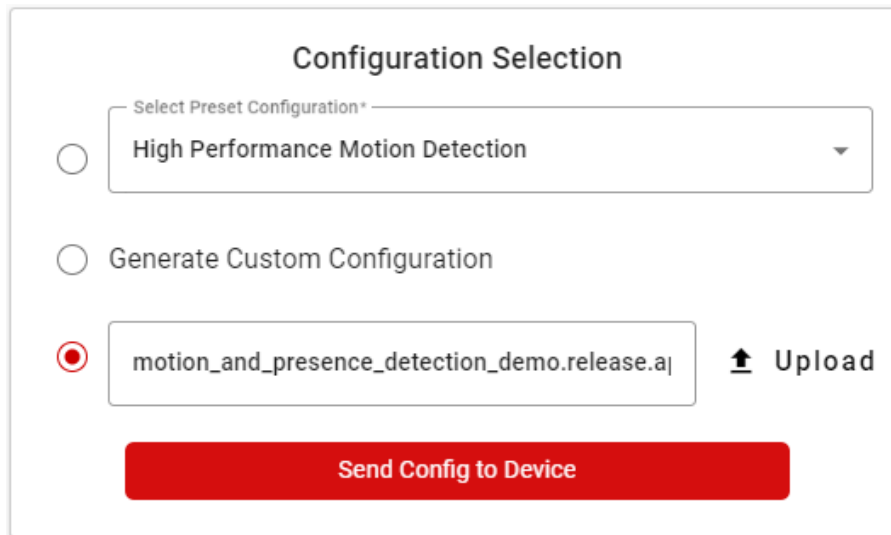

Figure 3-7. MmWave Radar Visualizer with Local Configuration File

Running mmWave Industrial Visualizer GUI

1. Open the GUI by clicking on *Industrial_Visualizer.exe*. The GUI is in the folder: *radar_toolbox_XX_XX_XX_XX\tools\visualizers\Applications_Visualizer\Industrial_Visualizer*.

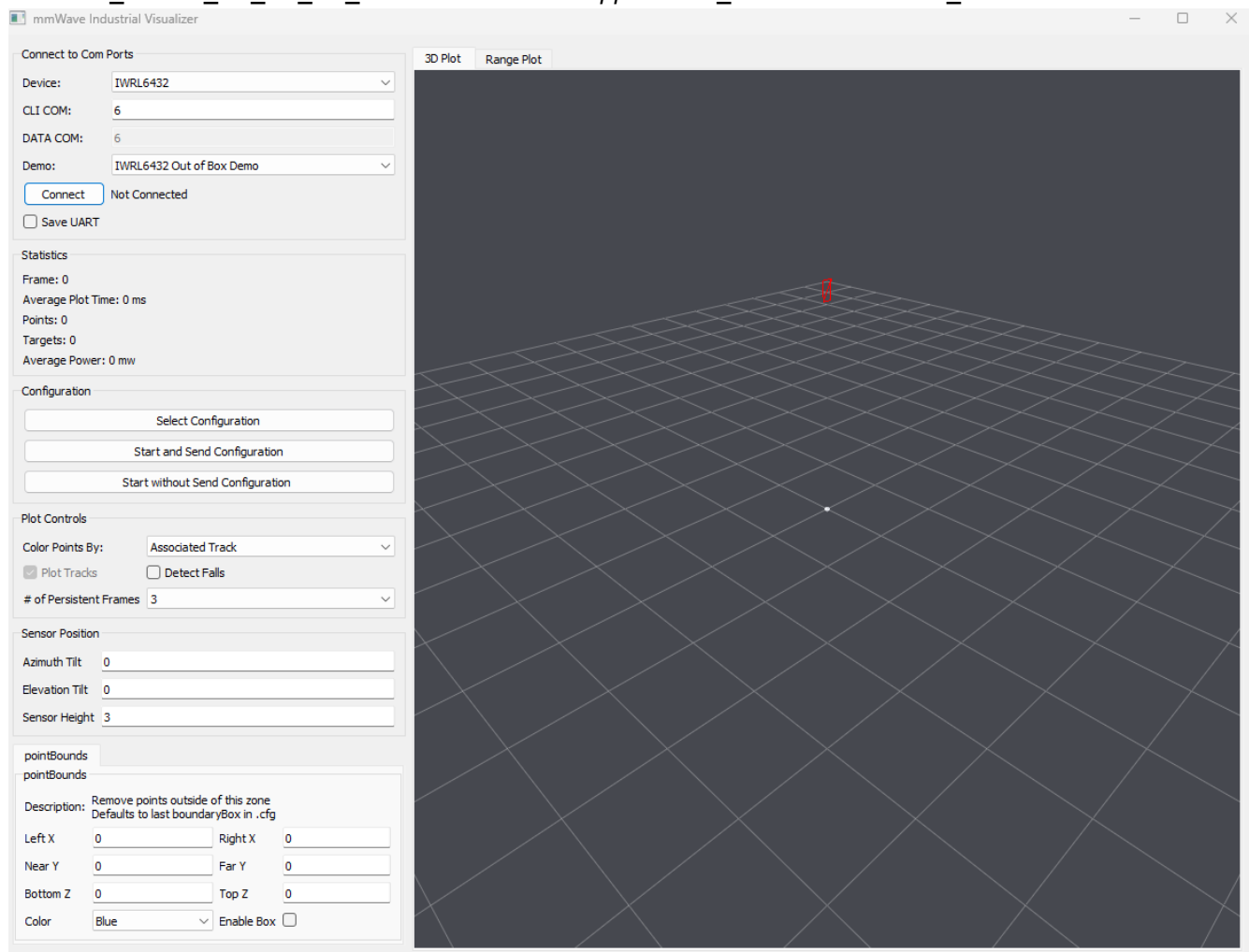

Figure 3-8. MmWave Industrial 3D Visualizer GUI

2. Make sure that the device selected is the *IWRL6432* and the demo selected is *IWRL6432 Out of Box Demo*.
3. For CLI COM, insert the COM port number that the device is connected to. Users can check this on the device manager. If the driver mentioned in [Section 2.3](#) is not installed, then this does not show up.

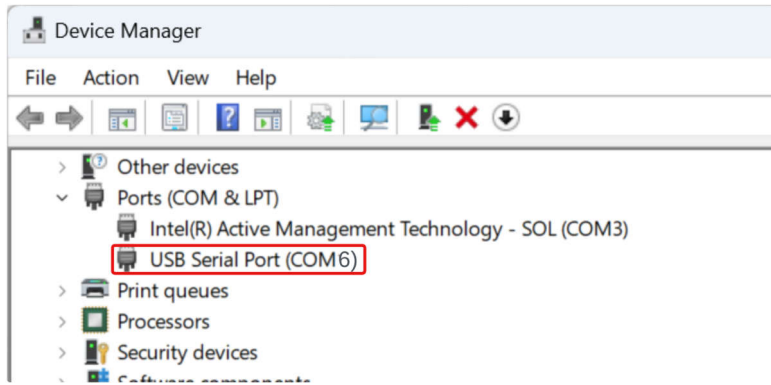

Figure 3-9. COM Port Selection in Device Manager

4. Click *Connect*. If connected properly, then the GUI displays *Connected*.
5. Open the *Tracking_MidBw.cfg* file in the folder:
`radar_toolbox_XX_XX_XX_XX\source\ti\examples\People_Tracking\IWRL6432_People_Tracking\chirp_configs\WRL6432BOOST.`
6. Click *Start and Send Configuration*.
7. If this works properly, then the console and the GUI outputs similar to [Figure 3-10](#).

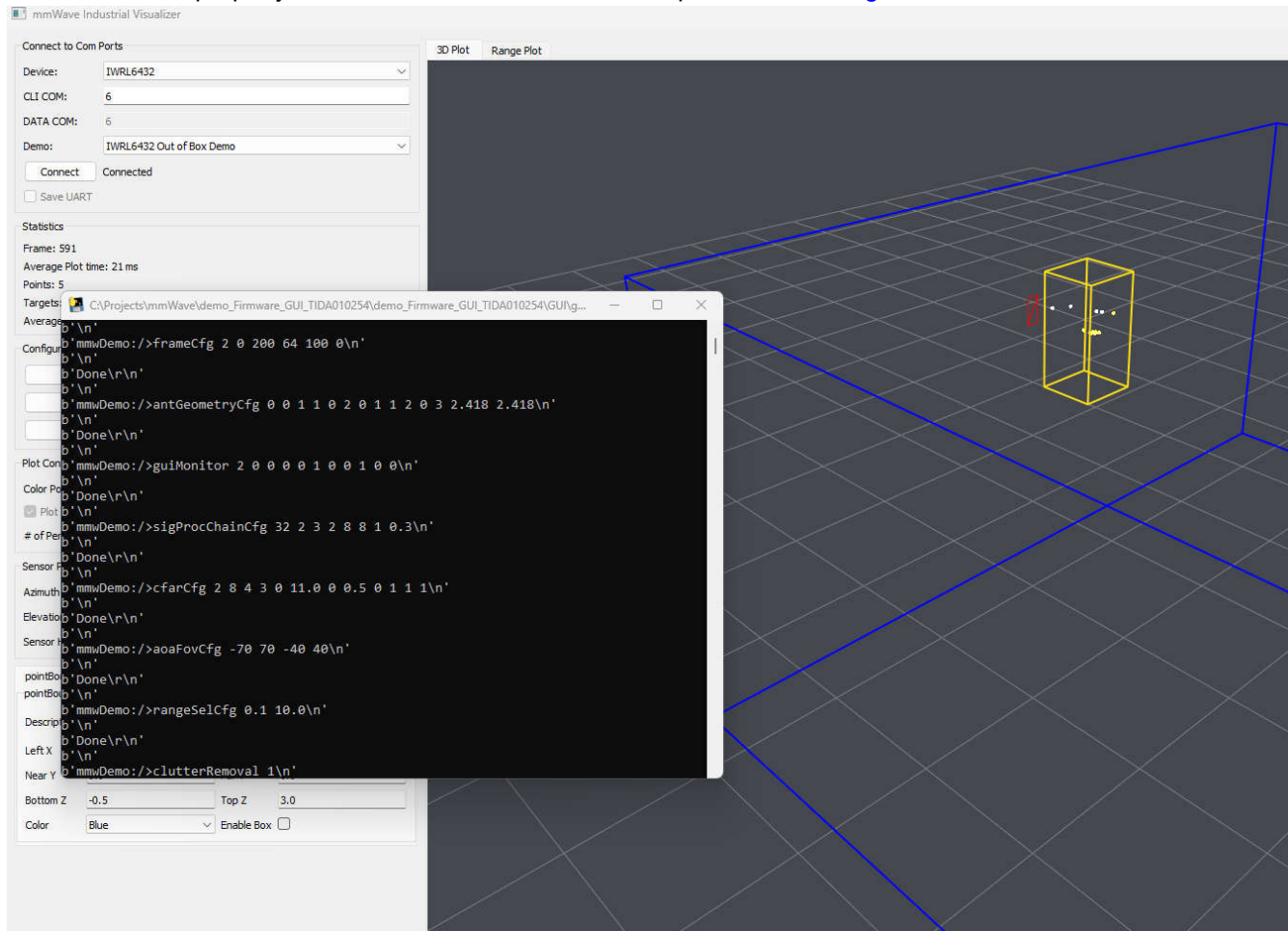

Figure 3-10. MmWave Industrial 3D Visualizer Output

3.1 IWRL6432FSP EVM in TIDA-010254 Reference Design

The IWRL6432FSP EVM is designed to be compatible with TI's TIDA-010254 reference design, an industrial reference design that demonstrates the use of a battery powered IWRL6432 60GHz mmWave radar with a sub-1 GHz or Bluetooth® 5.2 wireless communication. This system design contains two modules: a radar module and the wireless radio communication module. These two modules are designated as the IWRL6432FSP EVM for the radar module, and Base Board for the wireless communication module.

This design has been demonstrated with people-counting and tracking, and motion tracking applications from a Li-battery that send out the result to a remote host by sub-1 GHz or Bluetooth, while also compatible with any existing IWRL6432 software. This reference design uses a LAUNCHXLCC1352R1 wireless microcontroller LaunchPad™ with a PC GUI to visually show radar sensing data and detecting results.

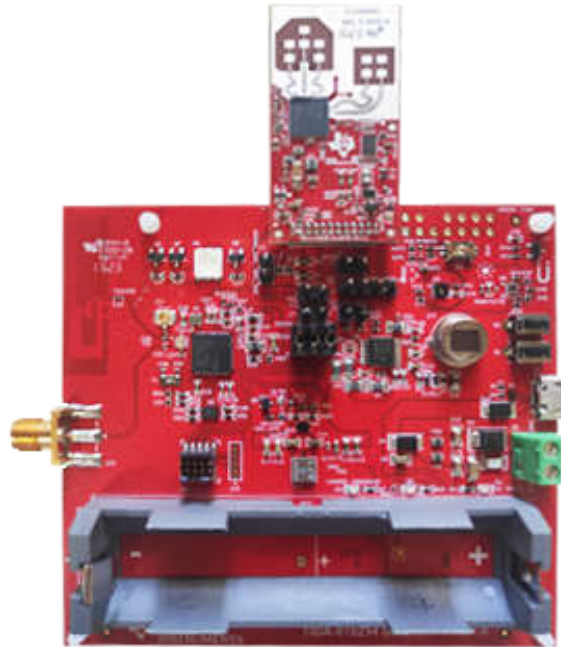

Figure 3-11. TIDA-010254 Reference Design

For more information and design files for the TIDA-010254 reference design, please refer to the [description page](#) on ti.com and the [TIDA-010254 design guide](#).

4 Hardware Design Files

4.1 Schematics

The schematics for this reference design can be downloaded at this link: [IWR6432FSPEVM Schematic](#). This can also be found on the [IWR6432FSPEVM tool page](#) under the *Design files* section.

4.2 PCB Layouts

The PCB layout for this reference design can be downloaded at this link: [IWR6432FSPEVM PCB Layouts](#) and can be found on the [IWR6432FSPEVM tools page](#) under the *Design files* section.

4.3 Bill of Materials (BOM)

The Bill of Materials for this reference design can be downloaded at this link: [IWR6432FSPEVM Bill of Materials](#). This can also be found on the [IWR6432FSPEVM tool page](#) under the *Design files* section.

5 Additional Information

5.1 Trademarks

LaunchPad™ is a trademark of Texas Instruments.
ARM® and Cortex® are registered trademarks of Arm Limited.
Bluetooth® is a registered trademark of Bluetooth SIG.
All trademarks are the property of their respective owners.

6 References

- Texas Instruments, [IWR6432 data sheet, product information and support](#), webpage
- Texas Instruments, [IWR6432 Single-Chip 57- to 64GHz Industrial Radar Sensor](#), data sheet
- Texas Instruments, [TIDA-010254 reference design | TI.com](#), webpage
- Texas Instruments, [Battery-Powered mmWave Radar Sensor w/ Sub-1 GHz and Bluetooth® 5.2](#), reference design
- Texas Instruments, [MMWAVE-L-SDK Software development kit \(SDK\)](#), webpage
- Texas Instruments, [Radar Toolbox](#), webpage

STANDARD TERMS FOR EVALUATION MODULES

1. *Delivery:* TI delivers TI evaluation boards, kits, or modules, including any accompanying demonstration software, components, and/or documentation which may be provided together or separately (collectively, an "EVM" or "EVMs") to the User ("User") in accordance with the terms set forth herein. User's acceptance of the EVM is expressly subject to the following terms.
 - 1.1 EVMs are intended solely for product or software developers for use in a research and development setting to facilitate feasibility evaluation, experimentation, or scientific analysis of TI semiconductors products. EVMs have no direct function and are not finished products. EVMs shall not be directly or indirectly assembled as a part or subassembly in any finished product. For clarification, any software or software tools provided with the EVM ("Software") shall not be subject to the terms and conditions set forth herein but rather shall be subject to the applicable terms that accompany such Software
 - 1.2 EVMs are not intended for consumer or household use. EVMs may not be sold, sublicensed, leased, rented, loaned, assigned, or otherwise distributed for commercial purposes by Users, in whole or in part, or used in any finished product or production system.
2. *Limited Warranty and Related Remedies/Disclaimers:*
 - 2.1 These terms do not apply to Software. The warranty, if any, for Software is covered in the applicable Software License Agreement.
 - 2.2 TI warrants that the TI EVM will conform to TI's published specifications for ninety (90) days after the date TI delivers such EVM to User. Notwithstanding the foregoing, TI shall not be liable for a nonconforming EVM if (a) the nonconformity was caused by neglect, misuse or mistreatment by an entity other than TI, including improper installation or testing, or for any EVMs that have been altered or modified in any way by an entity other than TI, (b) the nonconformity resulted from User's design, specifications or instructions for such EVMs or improper system design, or (c) User has not paid on time. Testing and other quality control techniques are used to the extent TI deems necessary. TI does not test all parameters of each EVM. User's claims against TI under this Section 2 are void if User fails to notify TI of any apparent defects in the EVMs within ten (10) business days after delivery, or of any hidden defects with ten (10) business days after the defect has been detected.
 - 2.3 TI's sole liability shall be at its option to repair or replace EVMs that fail to conform to the warranty set forth above, or credit User's account for such EVM. TI's liability under this warranty shall be limited to EVMs that are returned during the warranty period to the address designated by TI and that are determined by TI not to conform to such warranty. If TI elects to repair or replace such EVM, TI shall have a reasonable time to repair such EVM or provide replacements. Repaired EVMs shall be warranted for the remainder of the original warranty period. Replaced EVMs shall be warranted for a new full ninety (90) day warranty period.

WARNING

Evaluation Kits are intended solely for use by technically qualified, professional electronics experts who are familiar with the dangers and application risks associated with handling electrical mechanical components, systems, and subsystems.

User shall operate the Evaluation Kit within TI's recommended guidelines and any applicable legal or environmental requirements as well as reasonable and customary safeguards. Failure to set up and/or operate the Evaluation Kit within TI's recommended guidelines may result in personal injury or death or property damage. Proper set up entails following TI's instructions for electrical ratings of interface circuits such as input, output and electrical loads.

NOTE:

EXPOSURE TO ELECTROSTATIC DISCHARGE (ESD) MAY CAUSE DEGRADATION OR FAILURE OF THE EVALUATION KIT; TI RECOMMENDS STORAGE OF THE EVALUATION KIT IN A PROTECTIVE ESD BAG.

3 Regulatory Notices:

3.1 United States

3.1.1 Notice applicable to EVMs not FCC-Approved:

FCC NOTICE: This kit is designed to allow product developers to evaluate electronic components, circuitry, or software associated with the kit to determine whether to incorporate such items in a finished product and software developers to write software applications for use with the end product. This kit is not a finished product and when assembled may not be resold or otherwise marketed unless all required FCC equipment authorizations are first obtained. Operation is subject to the condition that this product not cause harmful interference to licensed radio stations and that this product accept harmful interference. Unless the assembled kit is designed to operate under part 15, part 18 or part 95 of this chapter, the operator of the kit must operate under the authority of an FCC license holder or must secure an experimental authorization under part 5 of this chapter.

3.1.2 For EVMs annotated as FCC – FEDERAL COMMUNICATIONS COMMISSION Part 15 Compliant:

CAUTION

This device complies with part 15 of the FCC Rules. Operation is subject to the following two conditions: (1) This device may not cause harmful interference, and (2) this device must accept any interference received, including interference that may cause undesired operation.

Changes or modifications not expressly approved by the party responsible for compliance could void the user's authority to operate the equipment.

FCC Interference Statement for Class A EVM devices

NOTE: This equipment has been tested and found to comply with the limits for a Class A digital device, pursuant to part 15 of the FCC Rules. These limits are designed to provide reasonable protection against harmful interference when the equipment is operated in a commercial environment. This equipment generates, uses, and can radiate radio frequency energy and, if not installed and used in accordance with the instruction manual, may cause harmful interference to radio communications. Operation of this equipment in a residential area is likely to cause harmful interference in which case the user will be required to correct the interference at his own expense.

FCC Interference Statement for Class B EVM devices

NOTE: This equipment has been tested and found to comply with the limits for a Class B digital device, pursuant to part 15 of the FCC Rules. These limits are designed to provide reasonable protection against harmful interference in a residential installation. This equipment generates, uses and can radiate radio frequency energy and, if not installed and used in accordance with the instructions, may cause harmful interference to radio communications. However, there is no guarantee that interference will not occur in a particular installation. If this equipment does cause harmful interference to radio or television reception, which can be determined by turning the equipment off and on, the user is encouraged to try to correct the interference by one or more of the following measures:

- Reorient or relocate the receiving antenna.
- Increase the separation between the equipment and receiver.
- Connect the equipment into an outlet on a circuit different from that to which the receiver is connected.
- Consult the dealer or an experienced radio/TV technician for help.

3.2 Canada

3.2.1 For EVMs issued with an Industry Canada Certificate of Conformance to RSS-210 or RSS-247

Concerning EVMs Including Radio Transmitters:

This device complies with Industry Canada license-exempt RSSs. Operation is subject to the following two conditions:

(1) this device may not cause interference, and (2) this device must accept any interference, including interference that may cause undesired operation of the device.

Concernant les EVMs avec appareils radio:

Le présent appareil est conforme aux CNR d'Industrie Canada applicables aux appareils radio exempts de licence. L'exploitation est autorisée aux deux conditions suivantes: (1) l'appareil ne doit pas produire de brouillage, et (2) l'utilisateur de l'appareil doit accepter tout brouillage radioélectrique subi, même si le brouillage est susceptible d'en compromettre le fonctionnement.

Concerning EVMs Including Detachable Antennas:

Under Industry Canada regulations, this radio transmitter may only operate using an antenna of a type and maximum (or lesser) gain approved for the transmitter by Industry Canada. To reduce potential radio interference to other users, the antenna type and its gain should be so chosen that the equivalent isotropically radiated power (e.i.r.p.) is not more than that necessary for successful communication. This radio transmitter has been approved by Industry Canada to operate with the antenna types listed in the user guide with the maximum permissible gain and required antenna impedance for each antenna type indicated. Antenna types not included in this list, having a gain greater than the maximum gain indicated for that type, are strictly prohibited for use with this device.

Concernant les EVMs avec antennes détachables

Conformément à la réglementation d'Industrie Canada, le présent émetteur radio peut fonctionner avec une antenne d'un type et d'un gain maximal (ou inférieur) approuvé pour l'émetteur par Industrie Canada. Dans le but de réduire les risques de brouillage radioélectrique à l'intention des autres utilisateurs, il faut choisir le type d'antenne et son gain de sorte que la puissance isotrope rayonnée équivalente (p.i.r.e.) ne dépasse pas l'intensité nécessaire à l'établissement d'une communication satisfaisante. Le présent émetteur radio a été approuvé par Industrie Canada pour fonctionner avec les types d'antenne énumérés dans le manuel d'usage et ayant un gain admissible maximal et l'impédance requise pour chaque type d'antenne. Les types d'antenne non inclus dans cette liste, ou dont le gain est supérieur au gain maximal indiqué, sont strictement interdits pour l'exploitation de l'émetteur.

3.3 Japan

3.3.1 *Notice for EVMs delivered in Japan:* Please see http://www.tij.co.jp/lstds/ti_ja/general/eStore/notice_01.page 日本国内に輸入される評価用キット、ボードについては、次のところをご覧ください。

<https://www.ti.com/ja-jp/legal/notice-for-evaluation-kits-delivered-in-japan.html>

3.3.2 *Notice for Users of EVMs Considered "Radio Frequency Products" in Japan:* EVMs entering Japan may not be certified by TI as conforming to Technical Regulations of Radio Law of Japan.

If User uses EVMs in Japan, not certified to Technical Regulations of Radio Law of Japan, User is required to follow the instructions set forth by Radio Law of Japan, which includes, but is not limited to, the instructions below with respect to EVMs (which for the avoidance of doubt are stated strictly for convenience and should be verified by User):

1. Use EVMs in a shielded room or any other test facility as defined in the notification #173 issued by Ministry of Internal Affairs and Communications on March 28, 2006, based on Sub-section 1.1 of Article 6 of the Ministry's Rule for Enforcement of Radio Law of Japan,
2. Use EVMs only after User obtains the license of Test Radio Station as provided in Radio Law of Japan with respect to EVMs, or
3. Use of EVMs only after User obtains the Technical Regulations Conformity Certification as provided in Radio Law of Japan with respect to EVMs. Also, do not transfer EVMs, unless User gives the same notice above to the transferee. Please note that if User does not follow the instructions above, User will be subject to penalties of Radio Law of Japan.

【無線電波を送信する製品の開発キットをお使いになる際の注意事項】 開発キットの中には技術基準適合証明を受けていないものがあります。技術適合証明を受けていないものご使用に際しては、電波法遵守のため、以下のいずれかの措置を取っていただく必要がありますのでご注意ください。

1. 電波法施行規則第6条第1項第1号に基づく平成18年3月28日総務省告示第173号で定められた電波暗室等の試験設備でご使用いただく。
2. 実験局の免許を取得後ご使用いただく。
3. 技術基準適合証明を取得後ご使用いただく。

なお、本製品は、上記の「ご使用にあたっての注意」を譲渡先、移転先に通知しない限り、譲渡、移転できないものとします。

上記を遵守頂けない場合は、電波法の罰則が適用される可能性があることをご留意ください。日本テキサス・イ

ンスツルメンツ株式会社

東京都新宿区西新宿 6 丁目 2 4 番 1 号

西新宿三井ビル

3.3.3 *Notice for EVMs for Power Line Communication:* Please see http://www.tij.co.jp/lstds/ti_ja/general/eStore/notice_02.page

電力線搬送波通信についての開発キットをお使いになる際の注意事項については、次のところをご覧ください。 <https://www.ti.com/ja-jp/legal/notice-for-evaluation-kits-for-power-line-communication.html>

3.4 European Union

3.4.1 *For EVMs subject to EU Directive 2014/30/EU (Electromagnetic Compatibility Directive):*

This is a class A product intended for use in environments other than domestic environments that are connected to a low-voltage power-supply network that supplies buildings used for domestic purposes. In a domestic environment this product may cause radio interference in which case the user may be required to take adequate measures.

-
4. *EVM Use Restrictions and Warnings:*
 - 4.1 EVMS ARE NOT FOR USE IN FUNCTIONAL SAFETY AND/OR SAFETY CRITICAL EVALUATIONS, INCLUDING BUT NOT LIMITED TO EVALUATIONS OF LIFE SUPPORT APPLICATIONS.
 - 4.2 User must read and apply the user guide and other available documentation provided by TI regarding the EVM prior to handling or using the EVM, including without limitation any warning or restriction notices. The notices contain important safety information related to, for example, temperatures and voltages.
 - 4.3 *Safety-Related Warnings and Restrictions:*
 - 4.3.1 User shall operate the EVM within TI's recommended specifications and environmental considerations stated in the user guide, other available documentation provided by TI, and any other applicable requirements and employ reasonable and customary safeguards. Exceeding the specified performance ratings and specifications (including but not limited to input and output voltage, current, power, and environmental ranges) for the EVM may cause personal injury or death, or property damage. If there are questions concerning performance ratings and specifications, User should contact a TI field representative prior to connecting interface electronics including input power and intended loads. Any loads applied outside of the specified output range may also result in unintended and/or inaccurate operation and/or possible permanent damage to the EVM and/or interface electronics. Please consult the EVM user guide prior to connecting any load to the EVM output. If there is uncertainty as to the load specification, please contact a TI field representative. During normal operation, even with the inputs and outputs kept within the specified allowable ranges, some circuit components may have elevated case temperatures. These components include but are not limited to linear regulators, switching transistors, pass transistors, current sense resistors, and heat sinks, which can be identified using the information in the associated documentation. When working with the EVM, please be aware that the EVM may become very warm.
 - 4.3.2 EVMs are intended solely for use by technically qualified, professional electronics experts who are familiar with the dangers and application risks associated with handling electrical mechanical components, systems, and subsystems. User assumes all responsibility and liability for proper and safe handling and use of the EVM by User or its employees, affiliates, contractors or designees. User assumes all responsibility and liability to ensure that any interfaces (electronic and/or mechanical) between the EVM and any human body are designed with suitable isolation and means to safely limit accessible leakage currents to minimize the risk of electrical shock hazard. User assumes all responsibility and liability for any improper or unsafe handling or use of the EVM by User or its employees, affiliates, contractors or designees.
 - 4.4 User assumes all responsibility and liability to determine whether the EVM is subject to any applicable international, federal, state, or local laws and regulations related to User's handling and use of the EVM and, if applicable, User assumes all responsibility and liability for compliance in all respects with such laws and regulations. User assumes all responsibility and liability for proper disposal and recycling of the EVM consistent with all applicable international, federal, state, and local requirements.
 5. *Accuracy of Information:* To the extent TI provides information on the availability and function of EVMs, TI attempts to be as accurate as possible. However, TI does not warrant the accuracy of EVM descriptions, EVM availability or other information on its websites as accurate, complete, reliable, current, or error-free.
 6. *Disclaimers:*
 - 6.1 EXCEPT AS SET FORTH ABOVE, EVMS AND ANY MATERIALS PROVIDED WITH THE EVM (INCLUDING, BUT NOT LIMITED TO, REFERENCE DESIGNS AND THE DESIGN OF THE EVM ITSELF) ARE PROVIDED "AS IS" AND "WITH ALL FAULTS." TI DISCLAIMS ALL OTHER WARRANTIES, EXPRESS OR IMPLIED, REGARDING SUCH ITEMS, INCLUDING BUT NOT LIMITED TO ANY EPIDEMIC FAILURE WARRANTY OR IMPLIED WARRANTIES OF MERCHANTABILITY OR FITNESS FOR A PARTICULAR PURPOSE OR NON-INFRINGEMENT OF ANY THIRD PARTY PATENTS, COPYRIGHTS, TRADE SECRETS OR OTHER INTELLECTUAL PROPERTY RIGHTS.
 - 6.2 EXCEPT FOR THE LIMITED RIGHT TO USE THE EVM SET FORTH HEREIN, NOTHING IN THESE TERMS SHALL BE CONSTRUED AS GRANTING OR CONFERRING ANY RIGHTS BY LICENSE, PATENT, OR ANY OTHER INDUSTRIAL OR INTELLECTUAL PROPERTY RIGHT OF TI, ITS SUPPLIERS/LICENSORS OR ANY OTHER THIRD PARTY, TO USE THE EVM IN ANY FINISHED END-USER OR READY-TO-USE FINAL PRODUCT, OR FOR ANY INVENTION, DISCOVERY OR IMPROVEMENT, REGARDLESS OF WHEN MADE, CONCEIVED OR ACQUIRED.
 7. *USER'S INDEMNITY OBLIGATIONS AND REPRESENTATIONS.* USER WILL DEFEND, INDEMNIFY AND HOLD TI, ITS LICENSORS AND THEIR REPRESENTATIVES HARMLESS FROM AND AGAINST ANY AND ALL CLAIMS, DAMAGES, LOSSES, EXPENSES, COSTS AND LIABILITIES (COLLECTIVELY, "CLAIMS") ARISING OUT OF OR IN CONNECTION WITH ANY HANDLING OR USE OF THE EVM THAT IS NOT IN ACCORDANCE WITH THESE TERMS. THIS OBLIGATION SHALL APPLY WHETHER CLAIMS ARISE UNDER STATUTE, REGULATION, OR THE LAW OF TORT, CONTRACT OR ANY OTHER LEGAL THEORY, AND EVEN IF THE EVM FAILS TO PERFORM AS DESCRIBED OR EXPECTED.
-

8. *Limitations on Damages and Liability:*

8.1 *General Limitations.* IN NO EVENT SHALL TI BE LIABLE FOR ANY SPECIAL, COLLATERAL, INDIRECT, PUNITIVE, INCIDENTAL, CONSEQUENTIAL, OR EXEMPLARY DAMAGES IN CONNECTION WITH OR ARISING OUT OF THESE TERMS OR THE USE OF THE EVMS , REGARDLESS OF WHETHER TI HAS BEEN ADVISED OF THE POSSIBILITY OF SUCH DAMAGES. EXCLUDED DAMAGES INCLUDE, BUT ARE NOT LIMITED TO, COST OF REMOVAL OR REINSTALLATION, ANCILLARY COSTS TO THE PROCUREMENT OF SUBSTITUTE GOODS OR SERVICES, RETESTING, OUTSIDE COMPUTER TIME, LABOR COSTS, LOSS OF GOODWILL, LOSS OF PROFITS, LOSS OF SAVINGS, LOSS OF USE, LOSS OF DATA, OR BUSINESS INTERRUPTION. NO CLAIM, SUIT OR ACTION SHALL BE BROUGHT AGAINST TI MORE THAN TWELVE (12) MONTHS AFTER THE EVENT THAT GAVE RISE TO THE CAUSE OF ACTION HAS OCCURRED.

8.2 *Specific Limitations.* IN NO EVENT SHALL TI'S AGGREGATE LIABILITY FROM ANY USE OF AN EVM PROVIDED HEREUNDER, INCLUDING FROM ANY WARRANTY, INDEMNITY OR OTHER OBLIGATION ARISING OUT OF OR IN CONNECTION WITH THESE TERMS, , EXCEED THE TOTAL AMOUNT PAID TO TI BY USER FOR THE PARTICULAR EVM(S) AT ISSUE DURING THE PRIOR TWELVE (12) MONTHS WITH RESPECT TO WHICH LOSSES OR DAMAGES ARE CLAIMED. THE EXISTENCE OF MORE THAN ONE CLAIM SHALL NOT ENLARGE OR EXTEND THIS LIMIT.

9. *Return Policy.* Except as otherwise provided, TI does not offer any refunds, returns, or exchanges. Furthermore, no return of EVM(s) will be accepted if the package has been opened and no return of the EVM(s) will be accepted if they are damaged or otherwise not in a resalable condition. If User feels it has been incorrectly charged for the EVM(s) it ordered or that delivery violates the applicable order, User should contact TI. All refunds will be made in full within thirty (30) working days from the return of the components(s), excluding any postage or packaging costs.

10. *Governing Law:* These terms and conditions shall be governed by and interpreted in accordance with the laws of the State of Texas, without reference to conflict-of-laws principles. User agrees that non-exclusive jurisdiction for any dispute arising out of or relating to these terms and conditions lies within courts located in the State of Texas and consents to venue in Dallas County, Texas. Notwithstanding the foregoing, any judgment may be enforced in any United States or foreign court, and TI may seek injunctive relief in any United States or foreign court.

Mailing Address: Texas Instruments, Post Office Box 655303, Dallas, Texas 75265
Copyright © 2023, Texas Instruments Incorporated

IMPORTANT NOTICE AND DISCLAIMER

TI PROVIDES TECHNICAL AND RELIABILITY DATA (INCLUDING DATA SHEETS), DESIGN RESOURCES (INCLUDING REFERENCE DESIGNS), APPLICATION OR OTHER DESIGN ADVICE, WEB TOOLS, SAFETY INFORMATION, AND OTHER RESOURCES "AS IS" AND WITH ALL FAULTS, AND DISCLAIMS ALL WARRANTIES, EXPRESS AND IMPLIED, INCLUDING WITHOUT LIMITATION ANY IMPLIED WARRANTIES OF MERCHANTABILITY, FITNESS FOR A PARTICULAR PURPOSE OR NON-INFRINGEMENT OF THIRD PARTY INTELLECTUAL PROPERTY RIGHTS.

These resources are intended for skilled developers designing with TI products. You are solely responsible for (1) selecting the appropriate TI products for your application, (2) designing, validating and testing your application, and (3) ensuring your application meets applicable standards, and any other safety, security, regulatory or other requirements.

These resources are subject to change without notice. TI grants you permission to use these resources only for development of an application that uses the TI products described in the resource. Other reproduction and display of these resources is prohibited. No license is granted to any other TI intellectual property right or to any third party intellectual property right. TI disclaims responsibility for, and you will fully indemnify TI and its representatives against, any claims, damages, costs, losses, and liabilities arising out of your use of these resources.

TI's products are provided subject to [TI's Terms of Sale](#) or other applicable terms available either on [ti.com](https://www.ti.com) or provided in conjunction with such TI products. TI's provision of these resources does not expand or otherwise alter TI's applicable warranties or warranty disclaimers for TI products.

TI objects to and rejects any additional or different terms you may have proposed.

Mailing Address: Texas Instruments, Post Office Box 655303, Dallas, Texas 75265

Copyright © 2025, Texas Instruments Incorporated