

100W CCM PFC Boost Converter Reference Design for Avionics



Description

This board is a compact, 360V_{DC}, 100W reference design for avionics applications, working with mains voltage range 90V_{AC} to 130V_{AC} and frequency range 400Hz to 800Hz. A single-phase continuous conduction mode (CCM) power factor correction (PFC) based on the UCC28180 is used to correct power factor and at the same time to minimize harmonic content of input current.

Features

- Simple single-phase PFC Boost with [UCC28180](#)
- Designed for avionics applications
- Covers 400Hz to 800Hz range
- 118.75mm × 47.63mm PCB

Applications

- [Standalone avionics PFC](#)

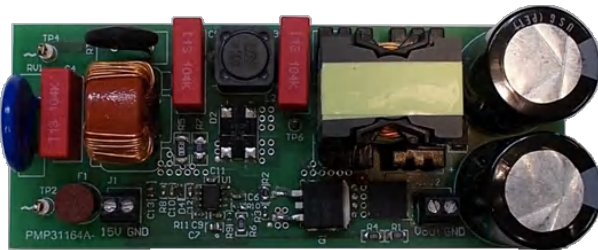

Top of Board

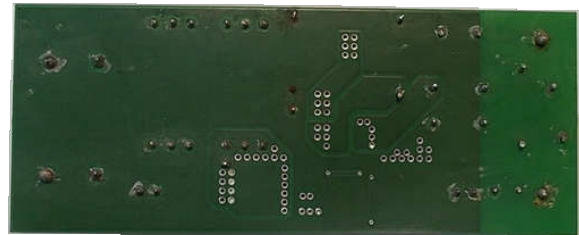

Bottom of Board

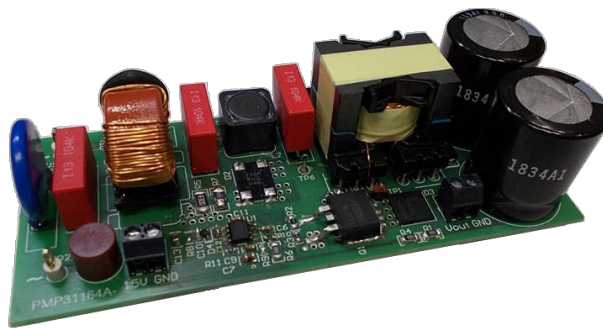

Angled View of Board

1 Test Prerequisites

1.1 Voltage and Current Requirements

Table 1-1. Voltage and Current Requirements

| Parameter | Specifications |
|----------------|---|
| Input Voltage | 90V _{AC} to 130V _{AC} |
| Frequency | 400Hz to 800Hz |
| Output Voltage | 360V _{DC} |
| Output Current | 280mA |

1.2 Required Equipment

- 0V_{AC} to 150V_{AC}, 400Hz to 800Hz (minimum current limit 2A_{RMS}) AC constant voltage source (VS1)
- Isolated electronic load with constant current range 0A to 1A, or power resistor (covering the range 1.2kΩ to 10kΩ)
- 12V isolated power supply (VS2)
- Oscilloscope (minimum 100MHz bandwidth)
- Current probe (minimum 100kHz bandwidth)
- Infrared camera

1.3 Testing Conditions

WARNING

High Voltage: Power supply is not isolated from AC input. Failure to follow warnings and instructions can result in personal injury, property damage, or death due to electrical shock and burn hazards.

1. Connect the source VS1 to TP2 and TP4
2. Connect the load to connector J2, with positive to pin 1
3. Connect the source VS2 to J1, with positive to pin 1
4. Attach a current probe in series to VS1 to measure the input current
5. Turn on VS1 (accepted range: 90V_{AC} to 130V_{AC}) and VS2 without any sequence restriction
6. Increase the load current on the output
7. After turn off, discharge the capacitors C1 and C2 by means of an external resistor (see [High Voltage Warning](#)) or active discharge circuit.

1.4 Considerations

The reference design PMP31164 Rev_B was built on PMP31164 Rev_A PCB.

1.5 Dimensions

The board dimensions of the two-layer board are 118.75mm × 47.63mm, height 26mm (electrolytic capacitors C1 and C2). The copper weight is 1oz on each layer.

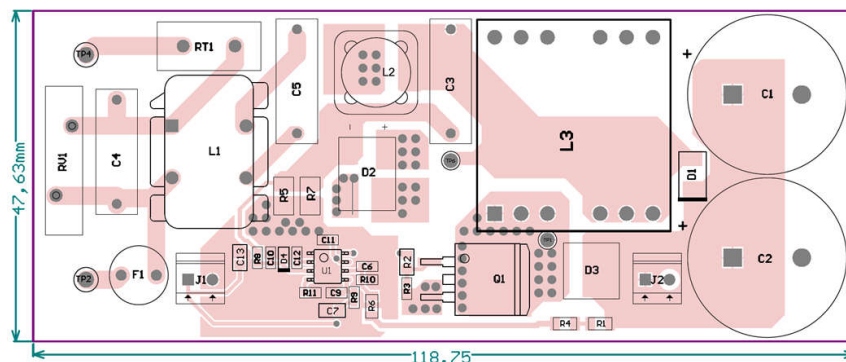
Figure 1-1. Board Outline

2 Testing and Results

2.1 Efficiency

The graphs in [Figure 2-1](#) and [Figure 2-2](#) show the converter efficiency versus output power, AC source voltage and frequency.

The input voltage was set to 90V_{AC}, 115V_{AC}, and 130V_{AC}, while the mains frequency was respectively 400Hz and 800Hz.

2.1.1 400Hz Mains Frequency

2.1.1.1 Efficiency Graph

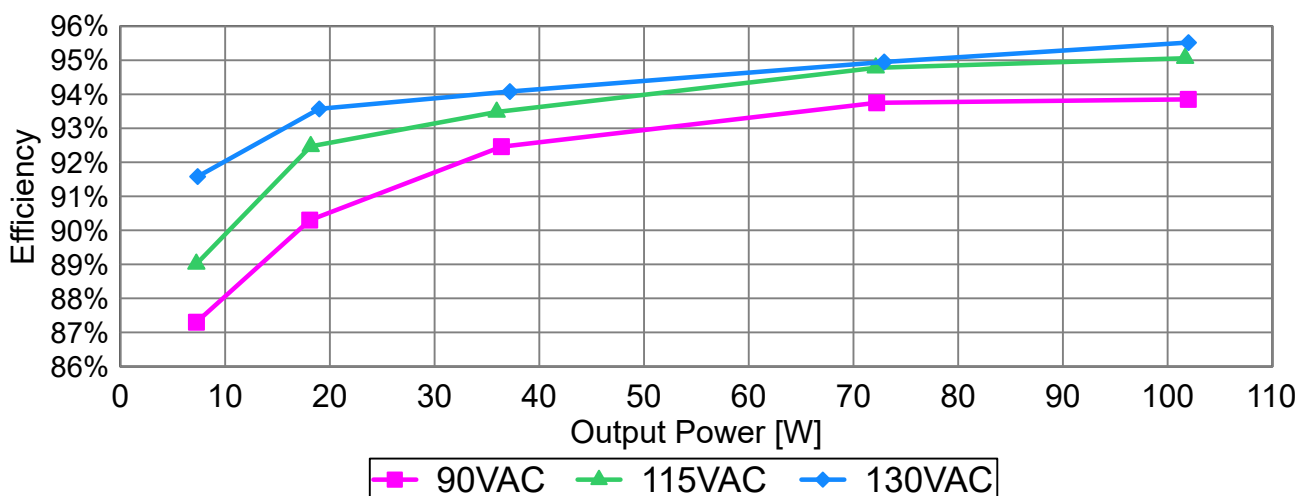

Figure 2-1. Efficiency Graph; 400Hz

2.1.1.2 Efficiency, Power Factor, and Input Current Harmonic Distortion (iTHD) Data

The [efficiency graph](#) report all data taken from following tables with the input voltage selected between 115V_{AC}, 90V_{AC}, and 130V_{AC}, while the frequency was set to 400Hz.

2.1.1.2.1 115V_{AC} Input Voltage

Efficiency Values for 115V_{AC} Input Voltage and 400Hz

| P _{IN} (W) | V _{OUT} (V) | I _{OUT} (mA) | iTHD (%) | Power Factor | P _{OUT} (W) | Efficiency (%) |
|---------------------|----------------------|-----------------------|----------|--------------|----------------------|----------------|
| 0.241 | 359.1 | 0.0 | 0.00 | 0.0000 | 0.00 | 0.00% |
| 8.147 | 359.0 | 20.2 | 20.5 | 0.6594 | 7.25 | 89.01% |
| 19.65 | 359.1 | 50.6 | 7.64 | 0.8782 | 18.17 | 92.47% |
| 38.43 | 359.3 | 100.0 | 5.35 | 0.9583 | 35.93 | 93.48% |
| 76.09 | 359.5 | 200.6 | 3.83 | 0.9878 | 72.12 | 94.78% |
| 106.95 | 359.9 | 282.5 | 3.57 | 0.9939 | 101.67 | 95.06% |

2.1.1.2.2 90V_{AC} Input Voltage
Efficiency Values for 90V_{AC} Input Voltage and 400Hz

| P _{IN} (W) | V _{OUT} (V) | I _{OUT} (mA) | iTHD (%) | Power Factor | P _{OUT} (W) | Efficiency (%) |
|---------------------|----------------------|-----------------------|----------|--------------|----------------------|----------------|
| 0.285 | 359.3 | 0.0 | 0.00 | 0.0000 | 0.00 | 0.00% |
| 8.314 | 359.3 | 20.2 | 19.2 | 0.8217 | 7.26 | 87.30% |
| 20.02 | 359.4 | 50.3 | 8.77 | 0.9468 | 18.08 | 90.30% |
| 39.35 | 359.5 | 101.2 | 4.71 | 0.9841 | 36.38 | 92.46% |
| 77.03 | 359.8 | 200.7 | 4.09 | 0.9957 | 72.21 | 93.75% |
| 108.66 | 360.2 | 283.1 | 4.38 | 0.9979 | 101.97 | 93.85% |

2.1.1.2.3 130V_{AC} Input Voltage
Efficiency Values for 130V_{AC} Input Voltage and 400Hz

| P _{IN} (W) | V _{OUT} (V) | I _{OUT} (mA) | iTHD (%) | Power Factor | P _{OUT} (W) | Efficiency (%) |
|---------------------|----------------------|-----------------------|----------|--------------|----------------------|----------------|
| 0.219 | 360.1 | 0.0 | 0.00 | 0.0000 | 0.00 | 0.00% |
| 8.056 | 359.9 | 20.5 | 20.8 | 0.5621 | 7.38 | 91.58% |
| 20.30 | 359.7 | 52.8 | 13.18 | 0.8472 | 18.99 | 93.57% |
| 39.53 | 359.7 | 103.4 | 5.59 | 0.9396 | 37.19 | 94.08% |
| 76.81 | 359.8 | 202.7 | 3.92 | 0.9814 | 72.93 | 94.95% |
| 106.77 | 360.0 | 283.3 | 3.50 | 0.9898 | 101.99 | 95.52% |

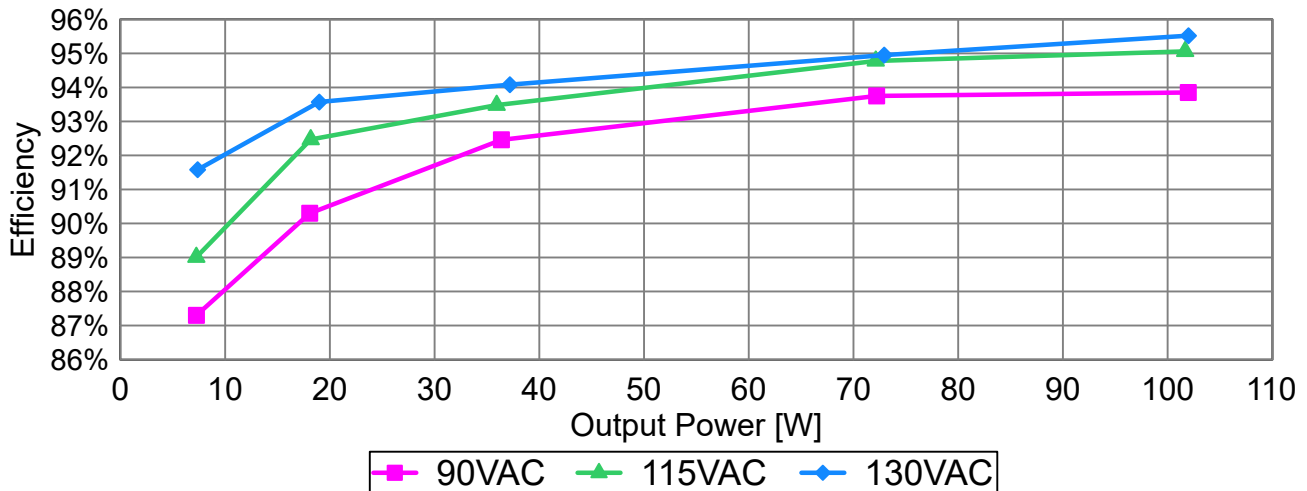
2.1.2 800Hz Mains Frequency
2.1.2.1 Efficiency Graph

Figure 2-2. Efficiency Graph; 800Hz

2.1.2.2 Efficiency, Power Factor, and Input Current Harmonic Distortion Data

The [efficiency graph](#) report all data taken from the following tables with the input voltage selected between $115V_{AC}$, $90V_{AC}$, and $130V_{AC}$, while the frequency was set to 800Hz.

2.1.2.2.1 $115V_{AC}$ Input Voltage

Efficiency Values for $115V_{AC}$ Input Voltage and 800Hz

| P_{IN} (W) | V_{OUT} (V) | I_{OUT} (mA) | iTHD (%) | Power Factor | P_{OUT} (W) | Efficiency (%) |
|--------------|---------------|----------------|----------|--------------|---------------|----------------|
| 0.279 | 358.8 | 0.0 | 0.00 | 0.0000 | 0.00 | 0.00% |
| 8.237 | 359.0 | 20.2 | 22.5 | 0.4108 | 7.25 | 88.04% |
| 19.71 | 359.1 | 50.4 | 14.54 | 0.7088 | 18.10 | 91.82% |
| 38.80 | 359.2 | 100.5 | 8.36 | 0.8700 | 36.10 | 93.04% |
| 76.50 | 359.5 | 201.4 | 5.19 | 0.9577 | 72.40 | 94.64% |
| 106.20 | 359.8 | 280.3 | 4.39 | 0.9786 | 100.85 | 94.96% |

2.1.2.2.2 $90V_{AC}$ Input Voltage

Efficiency Values for $90V_{AC}$ Input Voltage and 800Hz

| P_{IN} (W) | V_{OUT} (V) | I_{OUT} (mA) | iTHD (%) | Power Factor | P_{OUT} (W) | Efficiency (%) |
|--------------|---------------|----------------|----------|--------------|---------------|----------------|
| 0.254 | 359.8 | 0.0 | 0.00 | 0.0000 | 0.00 | 0.00% |
| 8.373 | 359.6 | 20.3 | 21.7 | 0.6032 | 7.30 | 87.18% |
| 20.08 | 359.5 | 50.3 | 9.23 | 0.8334 | 18.08 | 90.08% |
| 40.37 | 359.6 | 103.8 | 6.04 | 0.9467 | 37.33 | 92.47% |
| 77.04 | 359.8 | 200.6 | 4.95 | 0.9858 | 72.18 | 93.69% |
| 108.10 | 360.1 | 281.5 | 4.97 | 0.9946 | 101.37 | 93.77% |

2.1.2.2.3 $130V_{AC}$ Input Voltage

Efficiency Values for $130V_{AC}$ Input Voltage and 800Hz

| P_{IN} (W) | V_{OUT} (V) | I_{OUT} (mA) | iTHD (%) | Power Factor | P_{OUT} (W) | Efficiency (%) |
|--------------|---------------|----------------|----------|--------------|---------------|----------------|
| 0.235 | 360.1 | 0.0 | 0.00 | 0.0000 | 0.00 | 0.00% |
| 8.462 | 359.9 | 20.4 | 23.1 | 0.3441 | 7.34 | 86.76% |
| 19.63 | 359.7 | 50.7 | 18.69 | 0.6349 | 18.24 | 92.93% |
| 39.32 | 359.7 | 102.5 | 10.27 | 0.8204 | 36.87 | 93.76% |
| 76.04 | 359.8 | 201.0 | 6.03 | 0.9336 | 72.32 | 95.11% |
| 107.00 | 360.0 | 283.7 | 4.78 | 0.9646 | 102.13 | 95.45% |

2.2 Thermal Images

The picture and table below show the thermal picture of the converter supplied at 115V_{AC} and 400Hz, taken after 30minutes soak time, at 25°C ambient temperature. The board runs at full load in still air condition, placed horizontal on the bench.

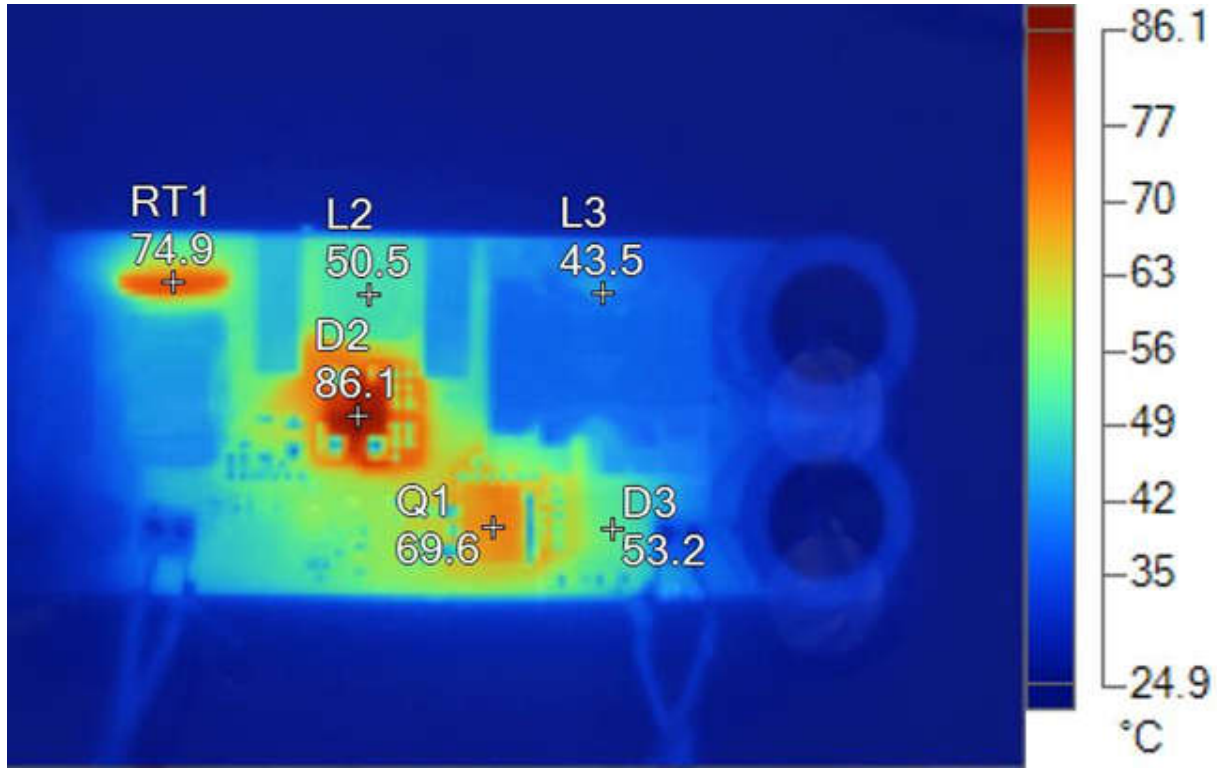

Figure 2-3. Thermal Image

Table 2-1. Main Image Markers

| Name | Temperature | Emissivity | Background |
|------|-------------|------------|------------|
| RT1 | 74.9°C | 0.96 | 25.5°C |
| D2 | 86.1°C | 0.96 | 25.5°C |
| Q1 | 69.6°C | 0.96 | 25.5°C |
| L3 | 43.5°C | 0.96 | 25.5°C |
| L2 | 50.5°C | 0.96 | 25.5°C |
| D3 | 53.2°C | 0.96 | 25.5°C |

2.3 Power Factor

The power factor value was measured by varying output power of the converter in the whole range, for different V_{AC} , repeated at 400Hz and 800Hz mains frequency.

2.3.1 400Hz Mains Frequency

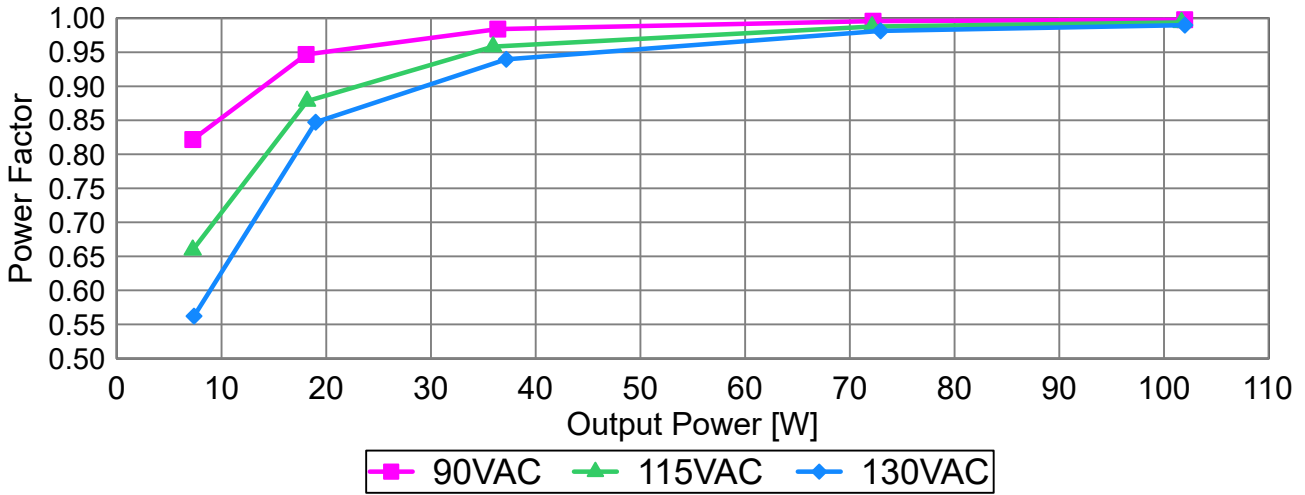

Figure 2-4. Power Factor; 400Hz

2.3.2 800Hz Mains Frequency

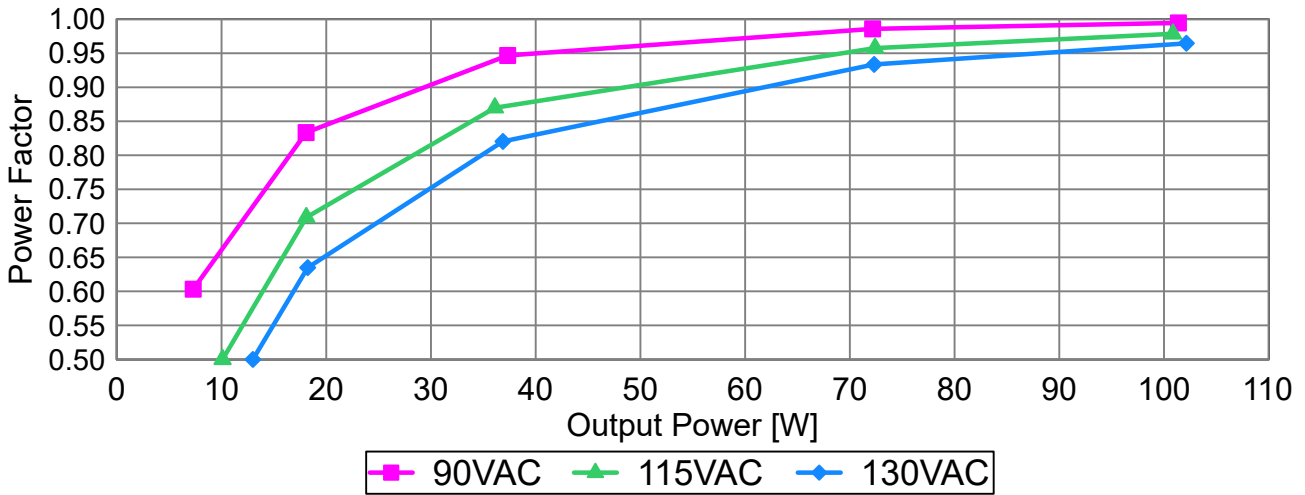

Figure 2-5. Power Factor; 800Hz

2.4 Total Harmonic Distortion (iTHD)

2.4.1 400Hz Mains Frequency

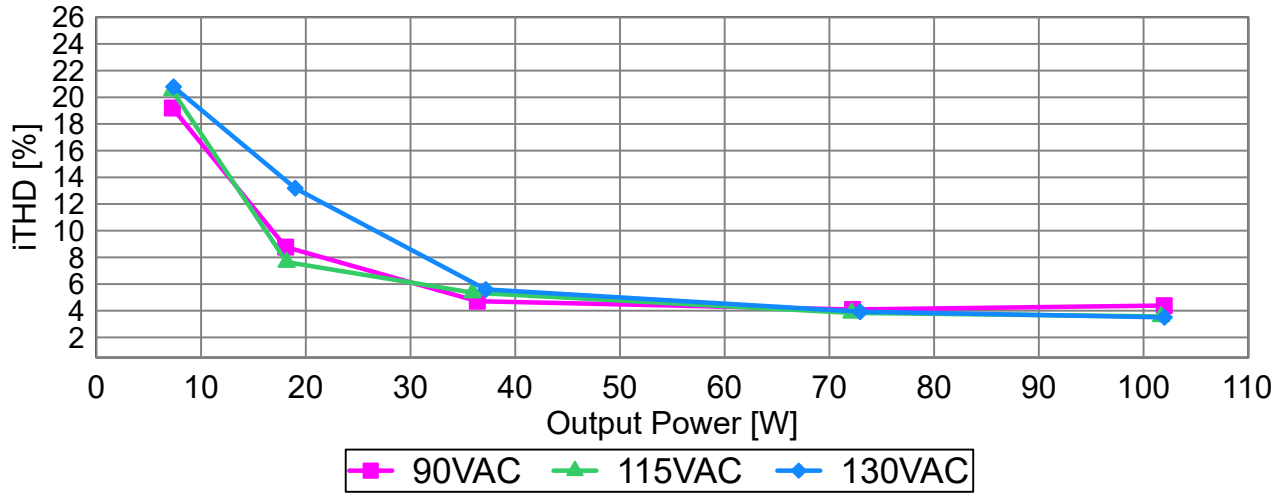

Figure 2-6. Total Harmonic Distortion (iTHD) at 400Hz

2.4.2 800Hz Mains Frequency

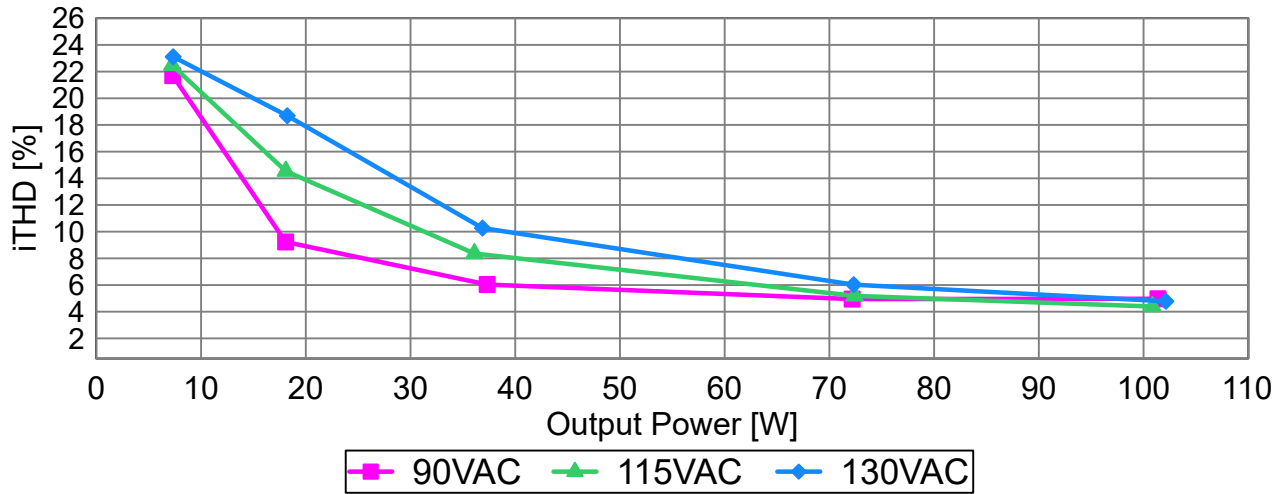

Figure 2-7. Total Harmonic Distortion (iTHD) at 800Hz

2.5 Static Output Voltage Variation versus Load

The output voltage regulation of the converter versus load current with frequency is shown in [Figure 2-8](#) (400Hz) and [Figure 2-9](#) (800Hz).

2.5.1 400Hz Mains Frequency

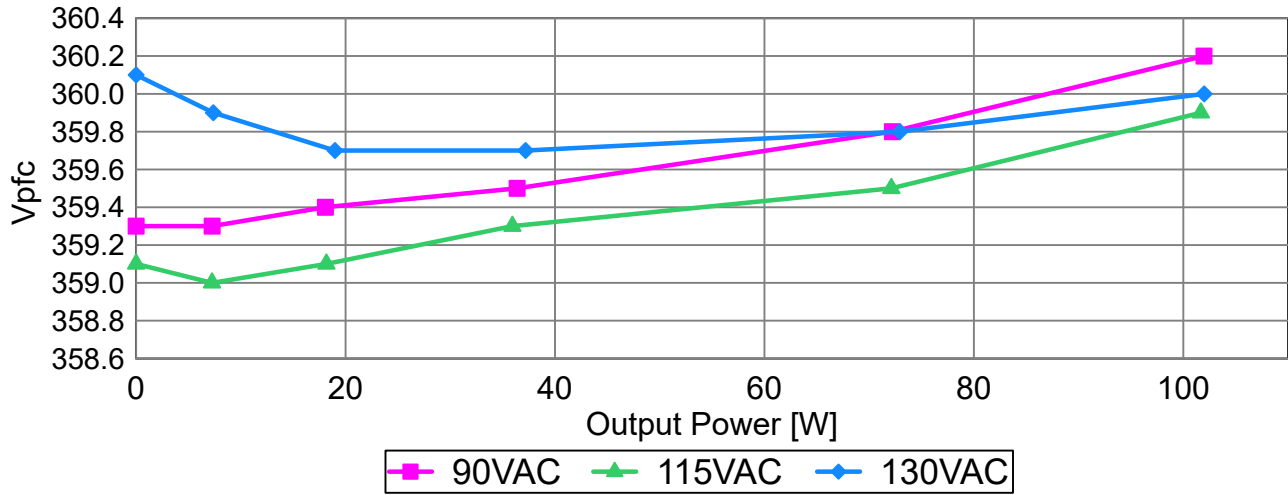

Figure 2-8. V_{pfc}; 400Hz

2.5.2 800Hz Mains Frequency

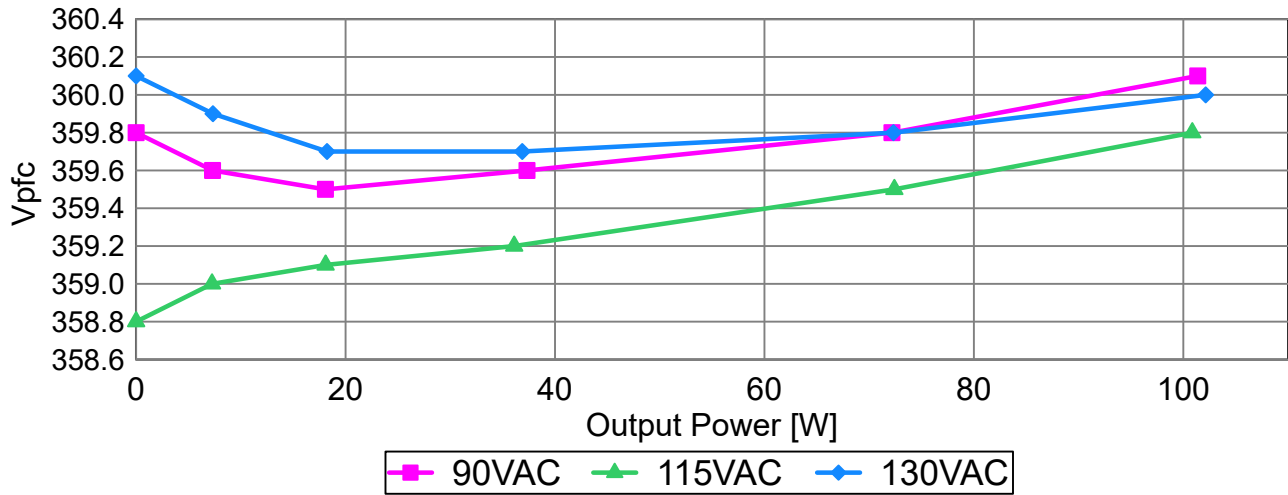

Figure 2-9. V_{pfc}; 800Hz

3 Waveforms

3.1 Switching Waveform on the Main FET at Full Load

The switching waveform was measured by supplying the converter at 115V_{AC}, 400Hz, and full load.

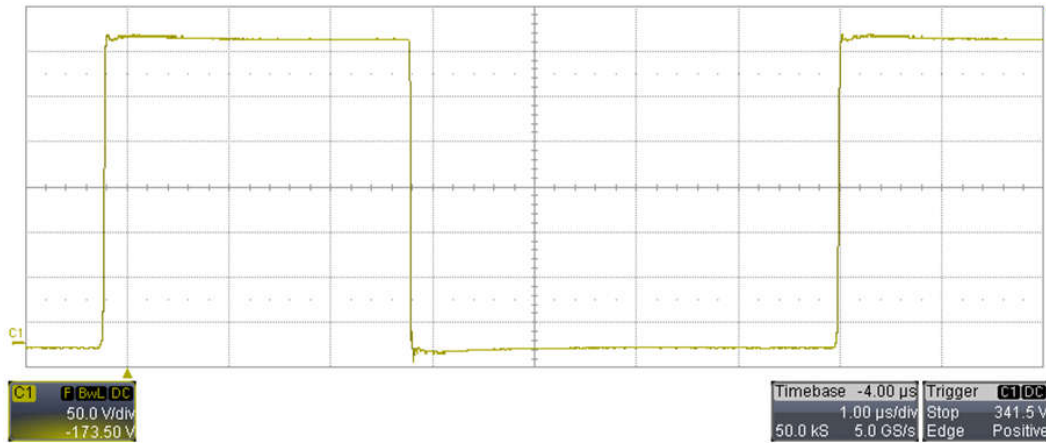

Figure 3-1. Q1 Drain to Source (50V/div, 1μs/div, 200MHz BWL)

3.2 AC Waveforms (Input Voltage and Current)

The screenshots show the input voltage and current of the PFC stage, at 90V_{AC}, 115V_{AC}, and 130V_{AC}, with mains frequency = 400Hz and 800Hz in full load condition (all waveforms with 20MHz BWL).

The following setup of the scope was used for all waveforms in this section which are:

- C1: AC input voltage (50V/div, DC coupling)
- C2: AC input current (500mA/div, DC coupling)

3.2.1 400Hz Mains Frequency

3.2.1.1 90V_{AC} Input Voltage

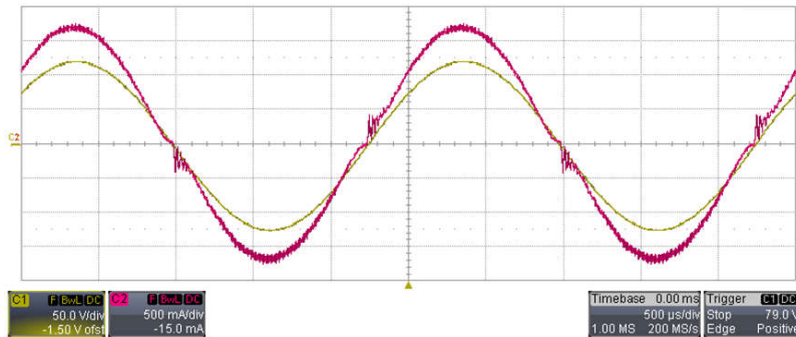

Figure 3-2. 90V_{AC} Input Voltage, 400Hz, 500µs/div

3.2.1.2 115V_{AC} Input Voltage

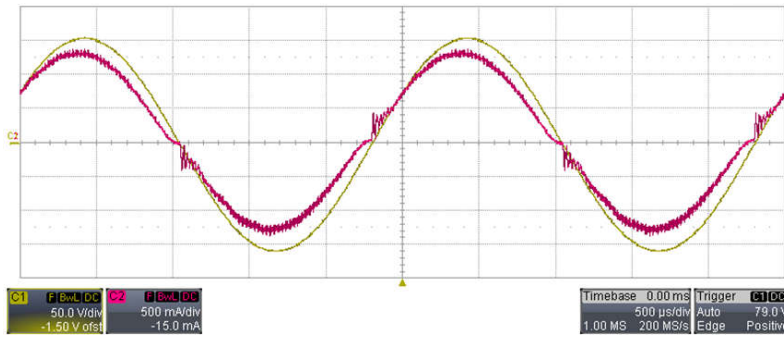

Figure 3-3. 115V_{AC} Input Voltage, 400Hz, 500µs/div

3.2.1.3 134V_{AC} Input Voltage

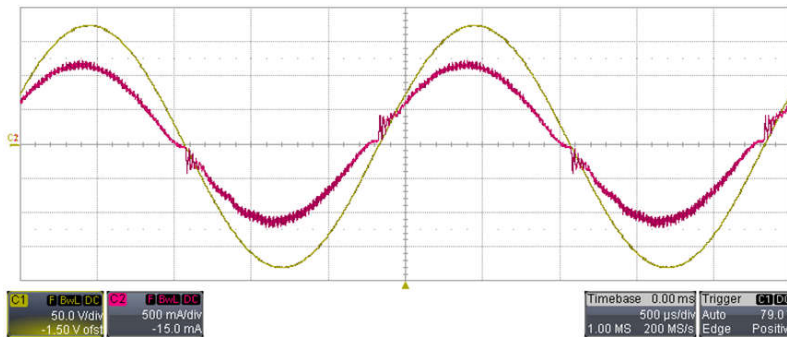

Figure 3-4. 134V_{AC} Input Voltage, 400Hz, 500µs/div

3.2.2 800Hz Mains Frequency

3.2.2.1 90V_{AC} Input Voltage

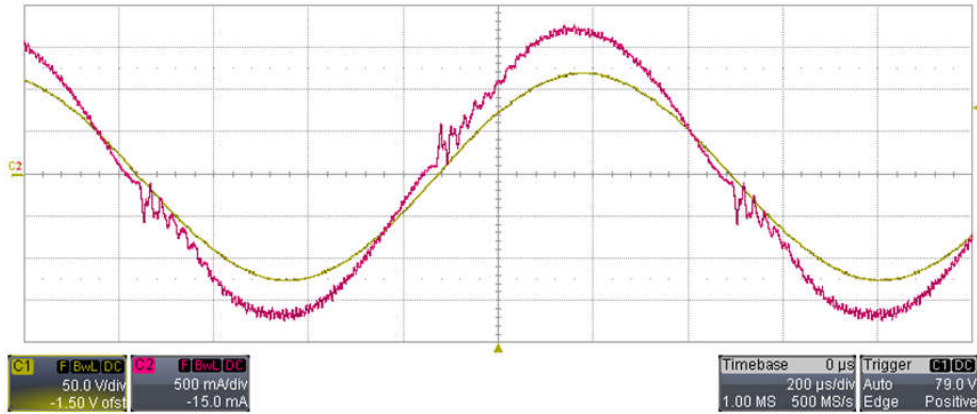

Figure 3-5. 90V_{AC} Input Voltage, 800Hz, 200μs/div

3.2.2.2 115V_{AC} Input Voltage

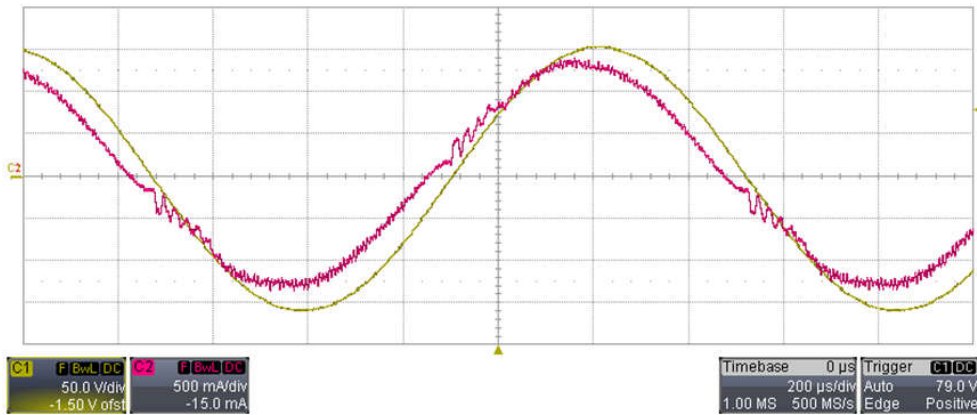

Figure 3-6. 115V_{AC} Input Voltage, 800Hz, 200μs/div

3.2.2.3 134V_{AC} Input Voltage

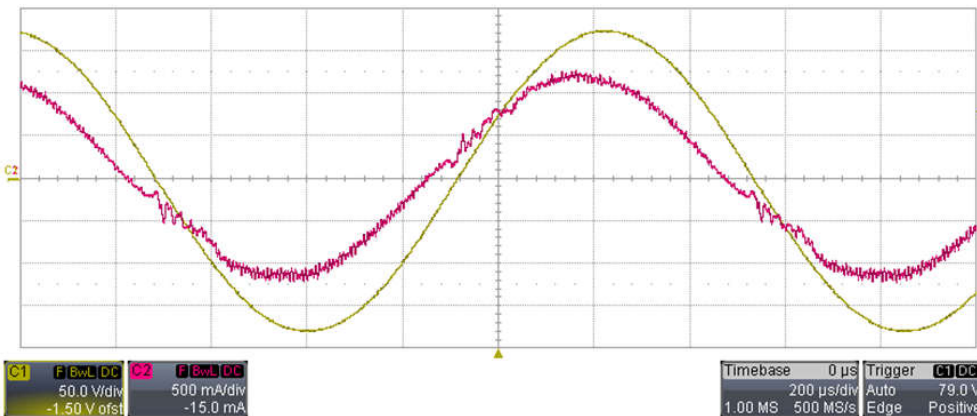

Figure 3-7. 134V_{AC} Input Voltage, 800Hz, 200μs/div

3.3 Output Voltage Ripple

The PFC output voltage ripple was measured by supplying the converter at 115V_{AC}, 400Hz at full load; the bandwidth limit of the scope (BWL) was set to 20MHz.

- **C1: AC input voltage (100V/div, 1ms/div, DC coupling)**
- **C3: DC output voltage (200mV/div, AC coupling)**

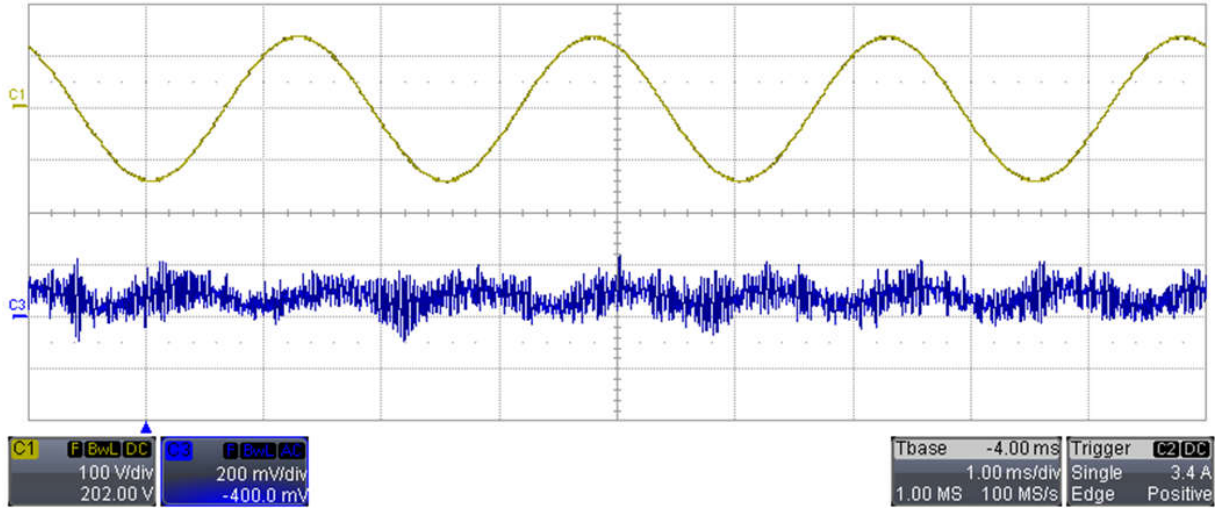

Figure 3-8. C3 DC Output Voltage, C1 AC Input Voltage

3.4 Load Transients

The output voltage variation, during load transients, was measured by supplying the converter at 115V_{AC} with $F_{\text{MAINS}} = 400\text{Hz}$. The load was switched between 100mA and 280mA (35.7% to 100% of the nominal load). This test was performed by connecting a fixed 3.6k Ω resistor (100mA fixed load) to the output and switching a 2k Ω on and off in parallel to the first resistor. For all waveforms the bandwidth limit of the oscilloscope was set to 20MHz.

- C3: Output voltage (10V/div, 20ms/div, AC coupling)
- C2: Output current (100mA/div, DC coupling)

3.4.1 100mA to 280mA

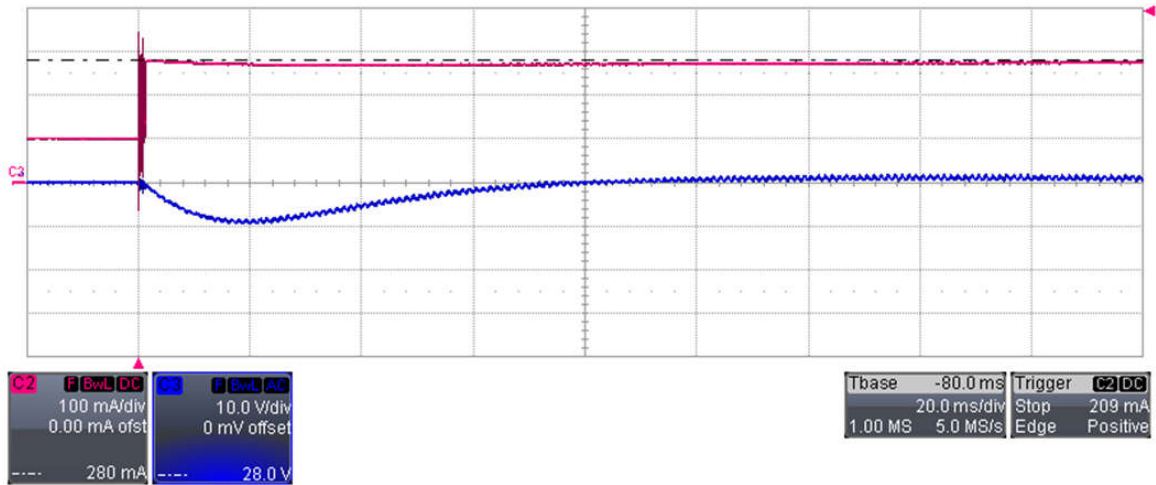

Figure 3-9. Output Current Switched From 100mA to 280mA

3.4.2 280mA to 100mA

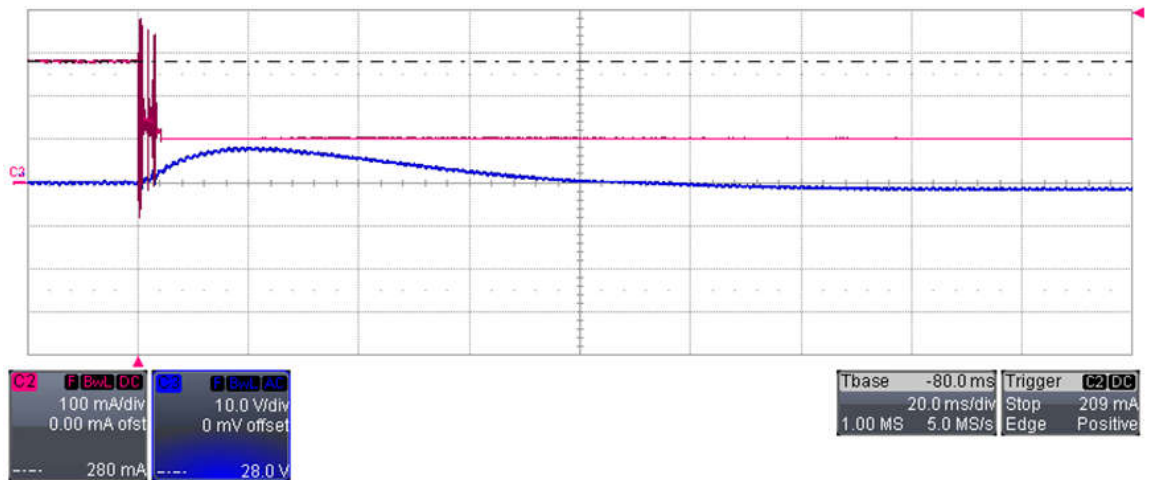

Figure 3-10. Output Current Switched From 280mA to 100mA

3.5 Inrush Current and Start-Up

During this test, the AC source was turned on with bias voltage already on. Both input current and voltage, as well as the output voltage, were measured (with 20MHz BWL). VAC and frequency were set respectively to 115V_{AC} and 400Hz.

- C3: Output voltage (100V/div, 20ms/div, DC coupling)
- C1: Input AC voltage (100V/div, DC coupling)
- C2: Input AC current (10A/div, DC coupling)

3.5.1 Full Load

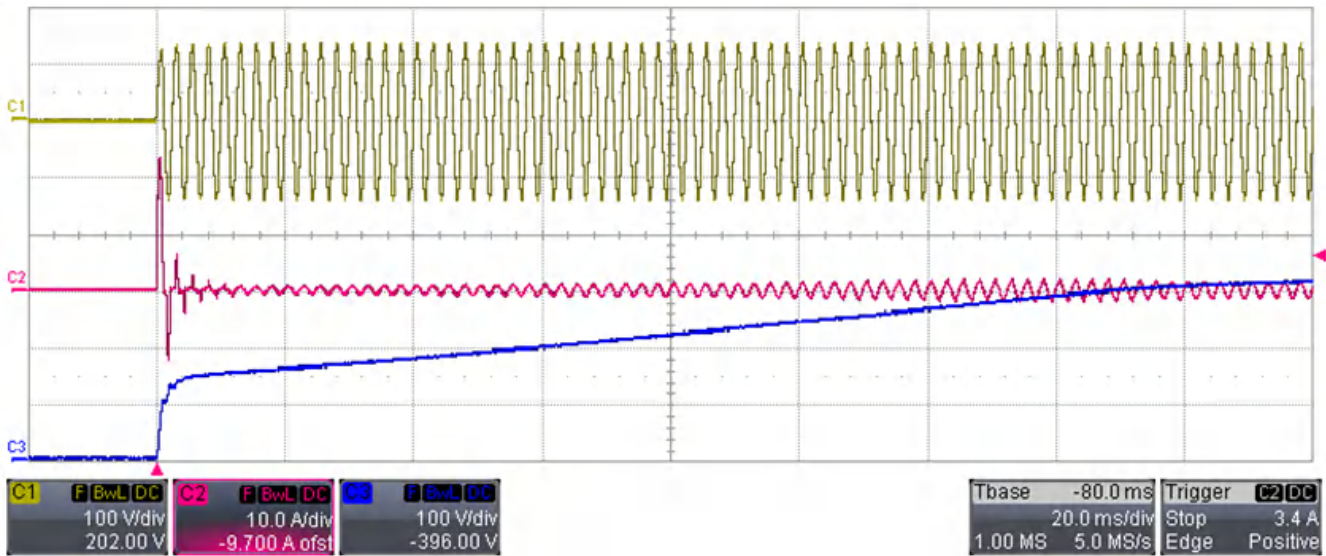

Figure 3-11. Start-Up With Full Load

3.5.2 Zero Load

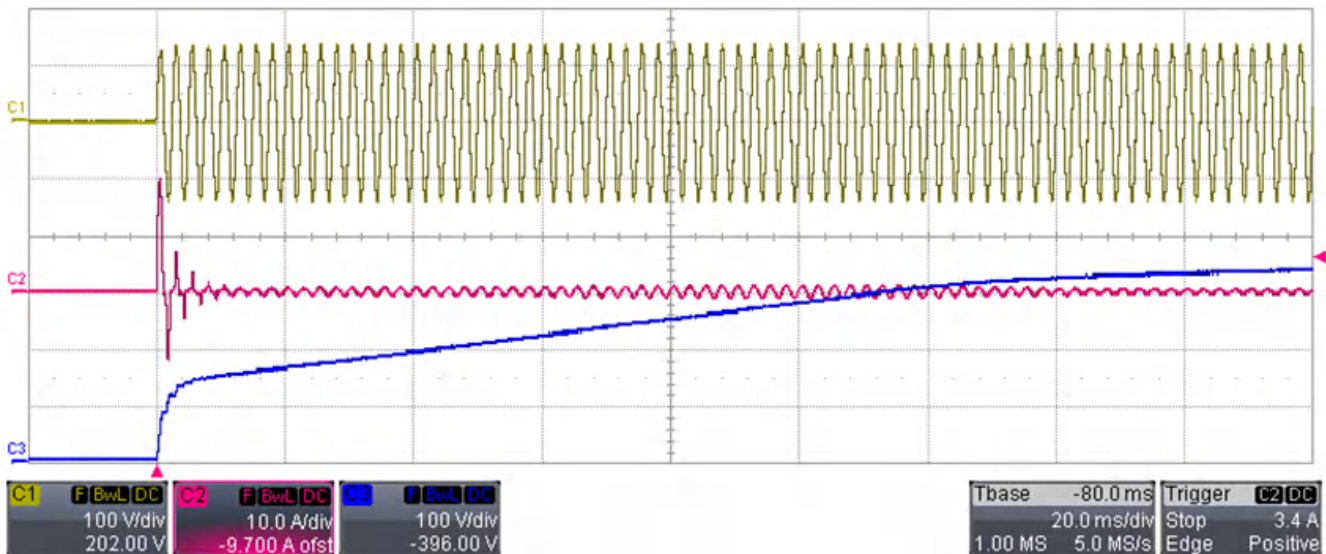

Figure 3-12. Start-Up With Zero Load

3.6 Input AC Current Measurements: Compliance to DO160 Harmonic Limits

All harmonics were tested according to the DO-160-G limits.

In details, the first harmonic (fundamental) of the current was measured at full load and nominal V_{AC} (in this case $115V_{AC}$). The AC source frequency was set to 400Hz, 600Hz. and 800Hz.

For all even harmonics with order greater than 4, an absolute limit of 10mA was considered, regardless on the order number (DO-160-G limits). All graphs show each harmonic current (in mA) versus number of orders.

3.6.1 400Hz Mains Frequency

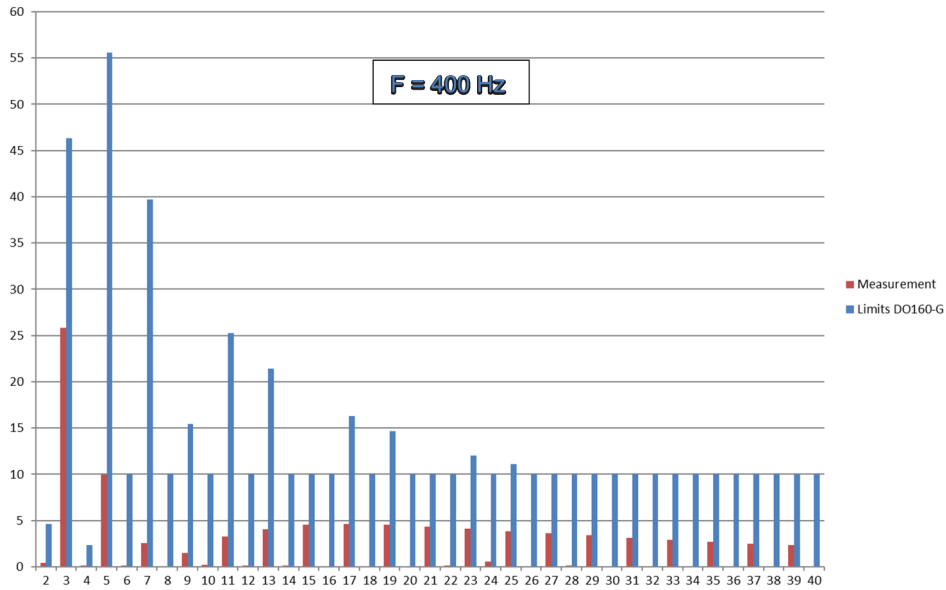

Figure 3-13. Harmonics of the Input Current at 400Hz Mains Frequency

3.6.2 600Hz Mains Frequency

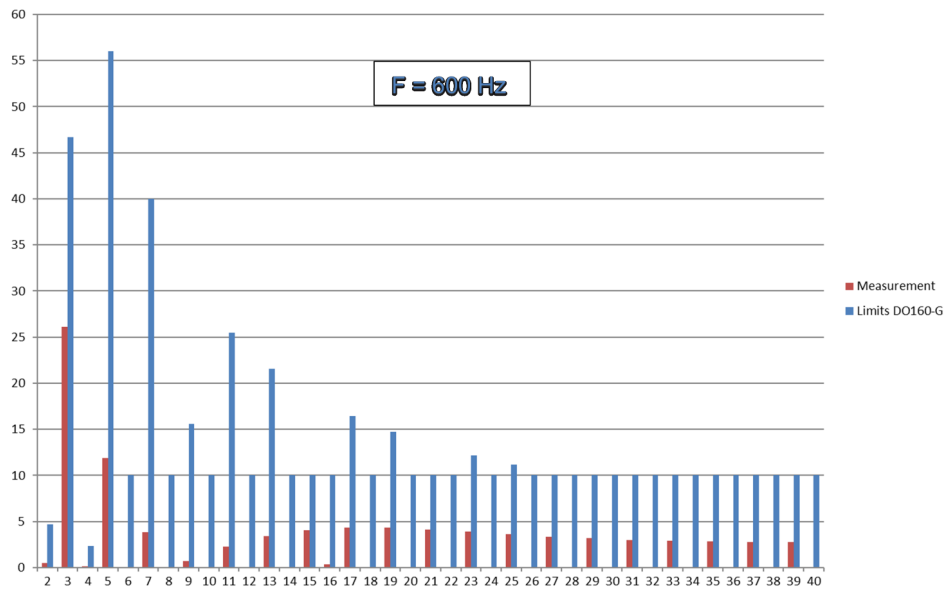

Figure 3-14. Harmonics of the Input Current at 600Hz Mains Frequency

3.6.3 800Hz Mains Frequency

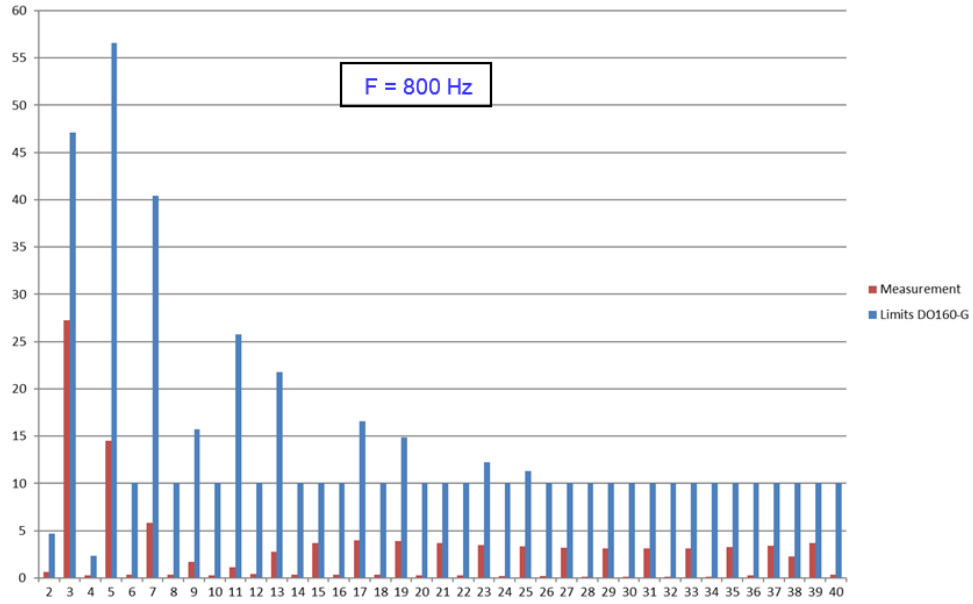

Figure 3-15. Harmonics of the Input Current at 800Hz Mains Frequency

IMPORTANT NOTICE AND DISCLAIMER

TI PROVIDES TECHNICAL AND RELIABILITY DATA (INCLUDING DATA SHEETS), DESIGN RESOURCES (INCLUDING REFERENCE DESIGNS), APPLICATION OR OTHER DESIGN ADVICE, WEB TOOLS, SAFETY INFORMATION, AND OTHER RESOURCES "AS IS" AND WITH ALL FAULTS, AND DISCLAIMS ALL WARRANTIES, EXPRESS AND IMPLIED, INCLUDING WITHOUT LIMITATION ANY IMPLIED WARRANTIES OF MERCHANTABILITY, FITNESS FOR A PARTICULAR PURPOSE OR NON-INFRINGEMENT OF THIRD PARTY INTELLECTUAL PROPERTY RIGHTS.

These resources are intended for skilled developers designing with TI products. You are solely responsible for (1) selecting the appropriate TI products for your application, (2) designing, validating and testing your application, and (3) ensuring your application meets applicable standards, and any other safety, security, regulatory or other requirements.

These resources are subject to change without notice. TI grants you permission to use these resources only for development of an application that uses the TI products described in the resource. Other reproduction and display of these resources is prohibited. No license is granted to any other TI intellectual property right or to any third party intellectual property right. TI disclaims responsibility for, and you will fully indemnify TI and its representatives against, any claims, damages, costs, losses, and liabilities arising out of your use of these resources.

TI's products are provided subject to [TI's Terms of Sale](#) or other applicable terms available either on [ti.com](https://www.ti.com) or provided in conjunction with such TI products. TI's provision of these resources does not expand or otherwise alter TI's applicable warranties or warranty disclaimers for TI products.

TI objects to and rejects any additional or different terms you may have proposed.

Mailing Address: Texas Instruments, Post Office Box 655303, Dallas, Texas 75265
Copyright © 2024, Texas Instruments Incorporated