

Antialiasing filter circuit design for single-ended ADC input using fixed cutoff frequency

Manuel Chavez

Input	ADC Input	Digital Output ADS8319
$V_{in\ Min} = 0.1V$	$V_{adc_in} = 4.9V$	FAE1 _H or 64225 ₁₀
$V_{in\ Max} = V_{REF} = 4.9V$	$V_{adc_in} = 0.1V$	051F _H or 1311 ₁₀

Power Supplies					
V_{cc}	V_{ee}	V_{cm}	V_{REF}	AVDD	DVDD
5.3V	GND (0V)	2.5V	5V	5V	5V

Design Description

This cookbook is intended to demonstrate a method of designing an antialiasing filter for a single-ended SAR ADC input using the Antialias Filter Designer on TI's [Analog Engineer's Calculator](#). The objective of the tool is to find filter specifications that will attenuate alias signals to one-half LSB of a given ADC. This design approach uses a fixed cutoff frequency and the example circuit uses the ADS8319 ADC. This single-ended device circuit is practical for low-power applications such as [Data Acquisition](#), [Lab Instrumentation](#), [Oscilloscopes](#), [Analog Input Module](#), and battery-powered equipment.

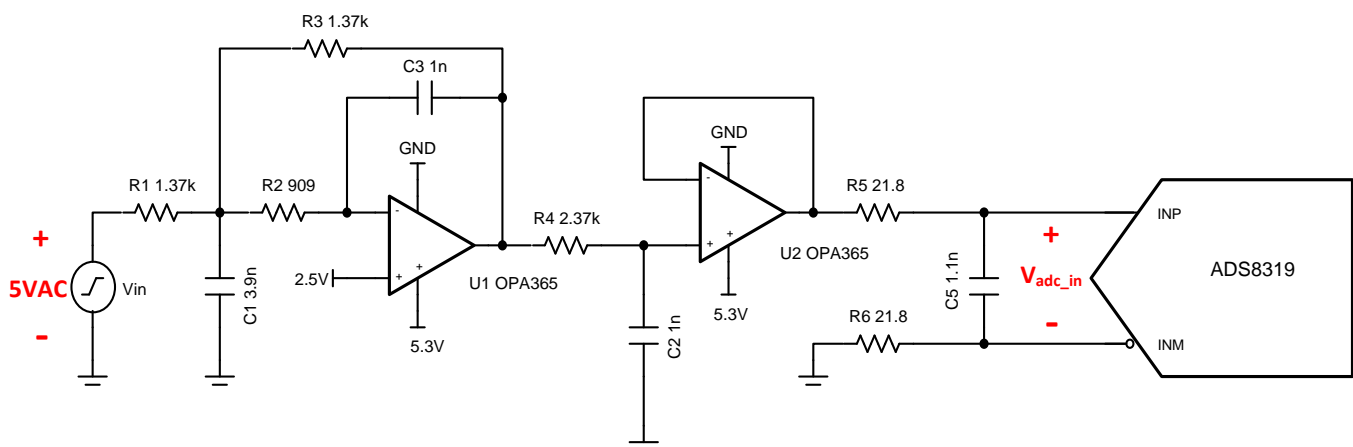

Specifications

Specification	Calculated / Goal	Simulated
Attenuate 1mV alias signal at Nyquist to ½ LSB $V_{in_Nyquist} = 1\text{mV}$ at 250kHz	$V_{out_Nyquist} \leq \frac{1}{2} \text{ LSB}$ $\frac{1}{2} \text{ LSB} = 38.14\mu\text{V}$ at 250kHz	$V_{out_Nyquist} = 21\mu\text{V}$ Attenuation = -33.43dB
Transient ADC Input Settling	< 0.5 LSB or 38.15μV	91.5nV
Noise	78.9μV	87.77μV
Bandwidth	50kHz	50.1kHz

Design Notes

1. *TI Precision Labs* introduces the concept of frequency domain aliasing and describes how aliases are error sources to avoid or minimize. The video on [Aliasing and Anti-aliasing Filters](#) covers how an antialiasing filter can be used to minimize these aliasing errors.
2. The active filter in this cookbook is designed using TI's [Analog Engineer's Calculator](#) and [TI FilterPro](#) (click to download). This software can be used to design active filter circuits for many applications.
3. Use 0.1%–1% tolerance resistors and 5% tolerance capacitors or better for good system accuracy.
4. RC charge bucket circuits are specially designed for each system; TI's Precision Labs video on [Refining Rfilt and Cfilt Values](#) explains how to optimize the RC charge bucket.
5. Circuit simulations are modeled with schematics and diagrams made using [TINA-TI](#) simulation software (click to download).
6. For detail on choosing the right driver op amp, building and simulating the ADC model, and finding the RC charge bucket values, see the TI Precision Labs video series [Introduction to SAR ADC Front-End Component Selection](#).

Component Selection

1. Once a single-ended ADC has been chosen, determine whether the antialias filter will be designed with a set cutoff frequency or set filter order. If the frequency is set, continue through the following steps. If the filter order is set, use the "Find Usable Frequency Range" tab in the Analog Engineer's Calculator. Both methods use tools from the [Analog Engineer's Calculator](#).
2. Using the *Find Filter Order* tab of the *Anti-Alias Filter Designer*, choose between a Bessel and Butterworth filter under *Choose Filter Type*. Bessel is chosen in this case for maximum flatness in the pass band and linear phase response.
3. Fill in the *Nyquist Frequency* to be $\frac{1}{2}$ of the sampling rate of the ADC. The ADS8319 has a sampling rate of 500ksps so the Nyquist frequency is 250kHz.
4. Determine the desired cutoff frequency of the filter to be designed and enter it in the *Cutoff Frequency* box; a general guideline is for the cutoff frequency to be one decade above the desired input frequency. In this case, the input frequency is 5kHz so the cutoff frequency is set to 50kHz.
5. For the *Alias Signal Amplitude at Nyquist Frequency* field, enter the largest expected alias signal amplitude that will be attenuated to $\frac{1}{2}$ LSB at the Nyquist frequency. This number can range from microvolts up to the full scale voltage. In this low-noise system, a maximum alias signal amplitude of 1mVpp is expected.
6. The *Full Scale Range* of the ADC is typically equal to V_{ref} and is set to 5V in this system. The bit resolution of the ADS8319 is 16 bits and is filled into *Number of Bits*.
7. After clicking *OK*, the results displayed on the right side of the calculator are used to design the necessary antialias filter.

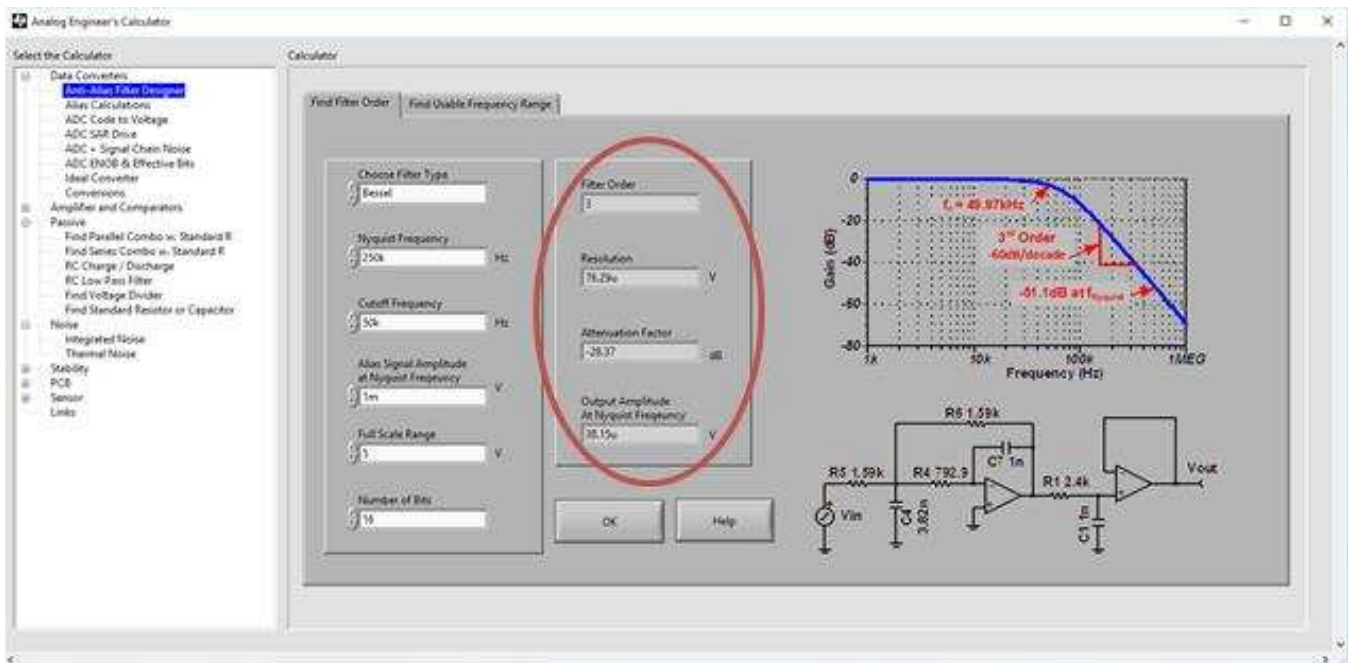

With the resulting filter specifications, the lowpass antialias filter can be designed by transcribing these numbers into [TI FilterPro](#). The circuit specifications in this cookbook are $f_{nyquist} = 250k$, $f_c = 50k$, $V_{alias} = 1mV$, $FSR = 5V$, and N bits = 16, so the Bessel example from Design Approach 1 is used continuing.

On startup, TI FilterPro asks for the filter specifications to design around. After the final screen, an active filter circuit is displayed, and this is the antialias filter of the system. Refer to the following screenshots for the steps using FilterPro.

In step 1, Lowpass is selected since an antialias filter is a specific lowpass filter.

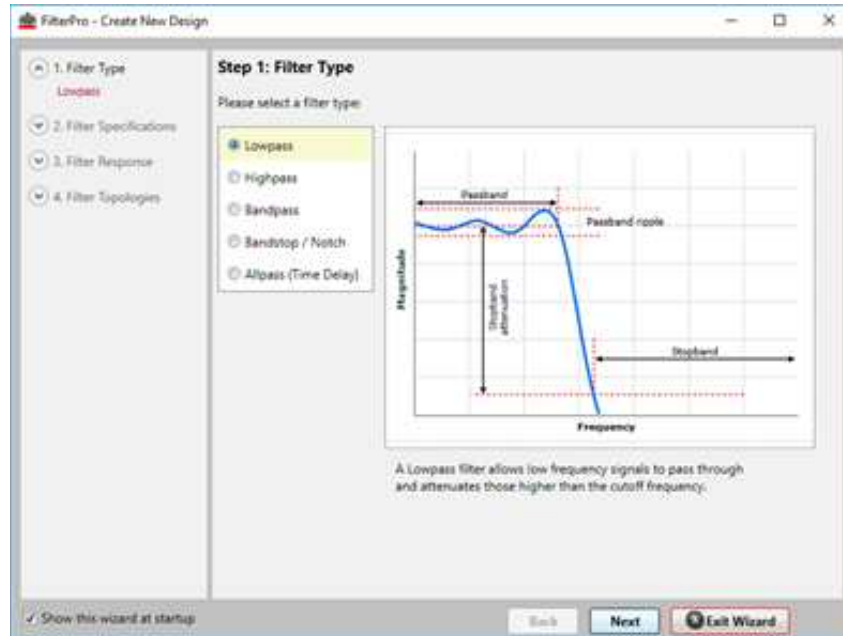

In step 2, the values for *Passband Frequency* (f_c) and filter order are filled in from the Analog Engineer's Calculator. The option to *Set Fixed* filter order must be selected to match calculated parameters.

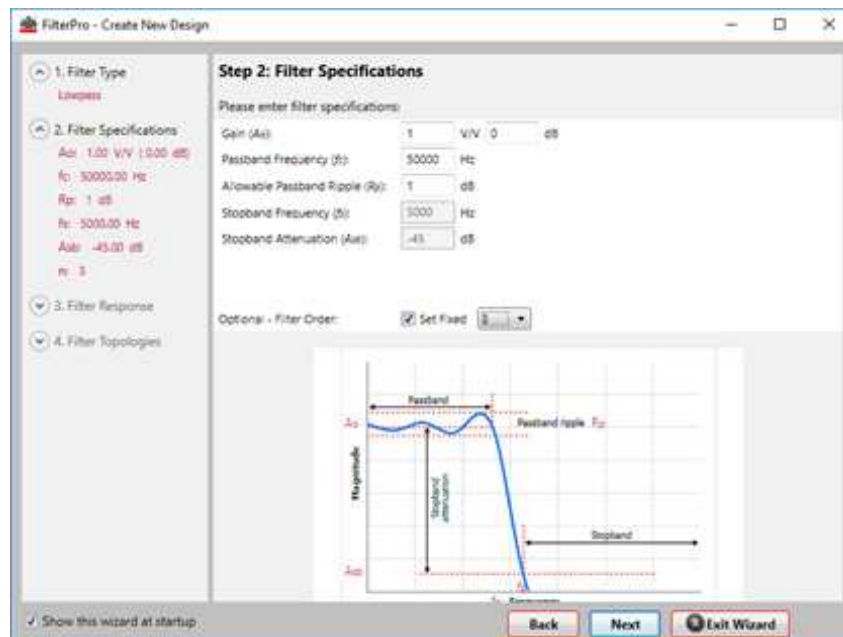

For step 3, select the filter type to match calculations; *Bessel* is chosen in this example for maximum flatness in the pass band and linear phase response.

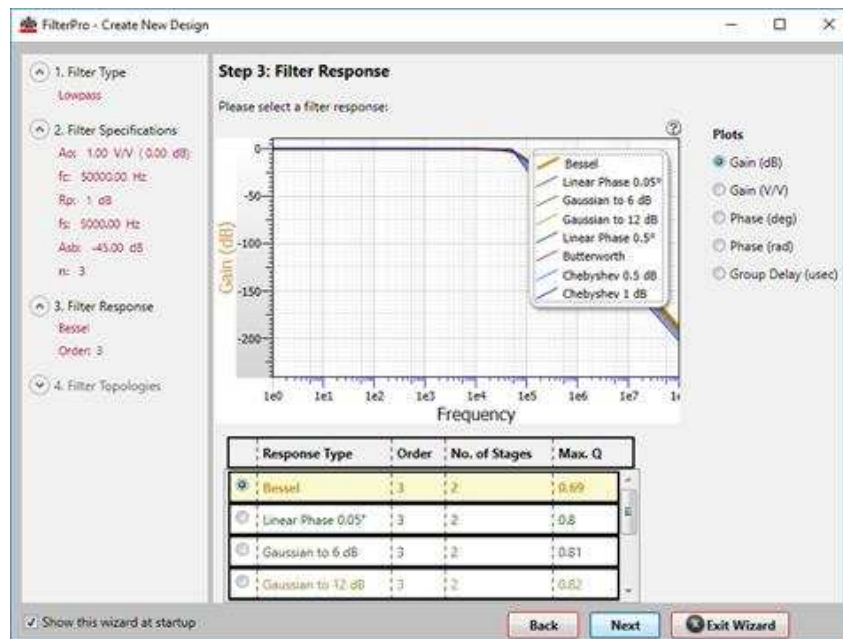

Multiple feedback topology is chosen in step 4 because the filter attenuation will not be limited by the bandwidth of the op amp. This topology has the disadvantages of inverting a signal and offering low input impedance. *Sallen-Key* can also be selected since it is a non-inverting topology with high-input impedance, but at higher frequencies the attenuation of the filter will converge or even rise due to the bandwidth limitations of the op amp.

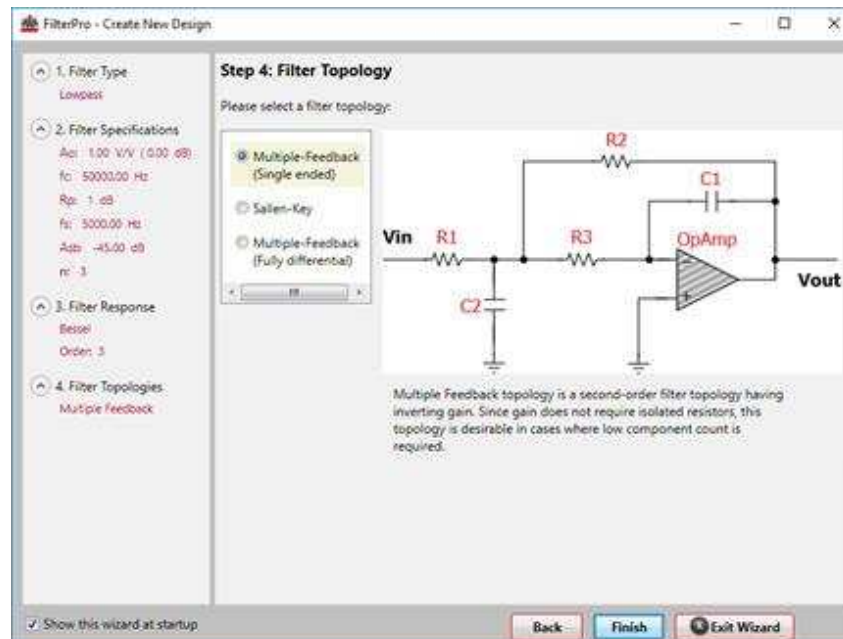

After clicking *Finish*, the filter schematic is displayed along with performance specifications of the resulting filter. Component tolerances can be adjusted using the right side drop-down menus; 1% resistors and 5% capacitors are chosen here as practical considerations. Component values can be modified by clicking on a number and entering new values.

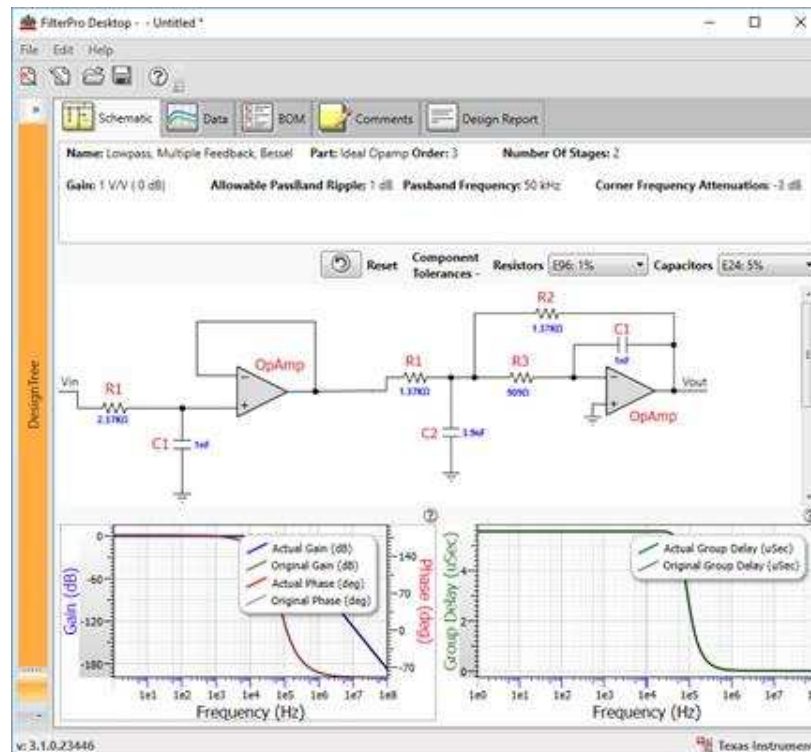

The circuit previously pictured can be designed in TINA-TI for simulation. Performance characteristics are documented in the following sections.

DC Transfer Characteristics

The following graph shows a linear output response for filter inputs from 0V to 5V. Since the filter amplifier is in inverting configuration, the output voltage is a function of $V_{out} = -V_{in} + 5V$.

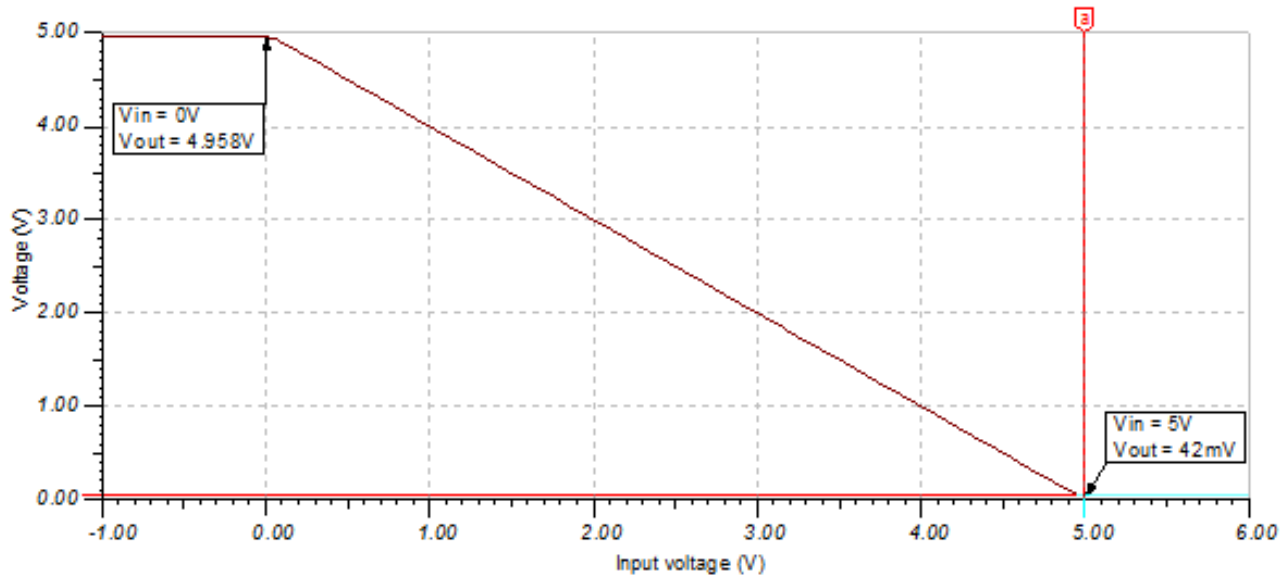

AC Transfer Characteristics

The bandwidth is simulated to be 50.1kHz, about 100Hz away from the desired value entered in the Analog Engineer's Calculator. At the Nyquist frequency, signals are attenuated by $-33.43dB$, which would lower the amplitude of the input alias signal to $21.3\mu V$. See the TI Precision Labs [Op Amps: Bandwidth 1](#) for more details on this subject.

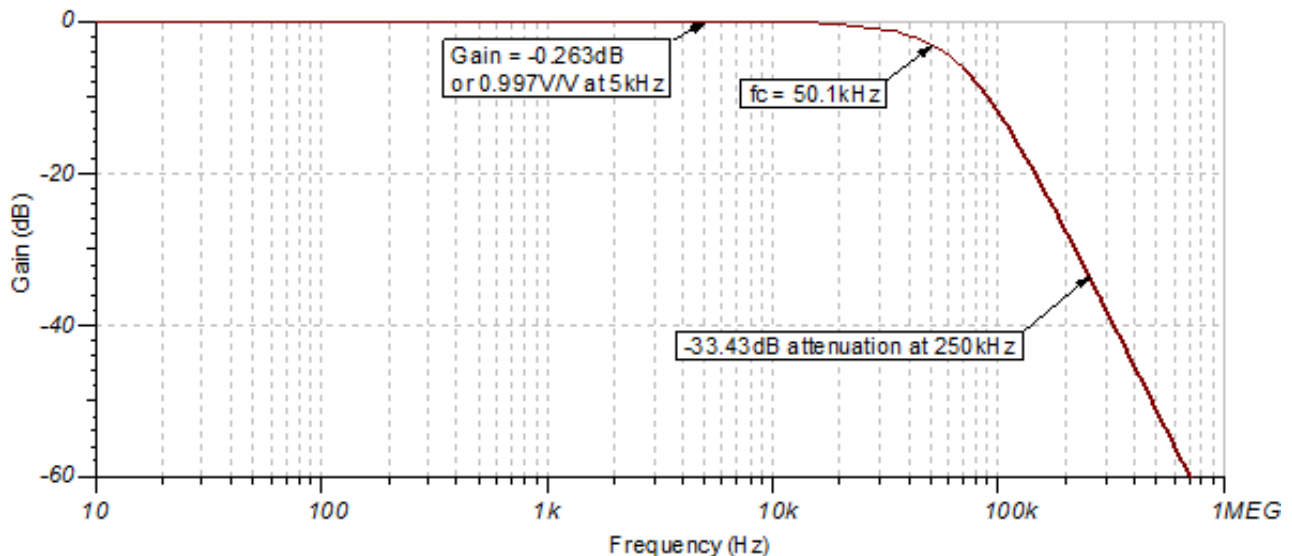

Transient ADC Input Settling Simulation

The following simulation shows the ADS8319 settling to a 5-Vpp AC signal at 5kHz through the data acquisition period. This type of simulation shows that the RC charge bucket components are properly selected. See the TI Precision Labs video on [Refine the Rfilt and Cfilt Values](#) for detailed theory on this subject.

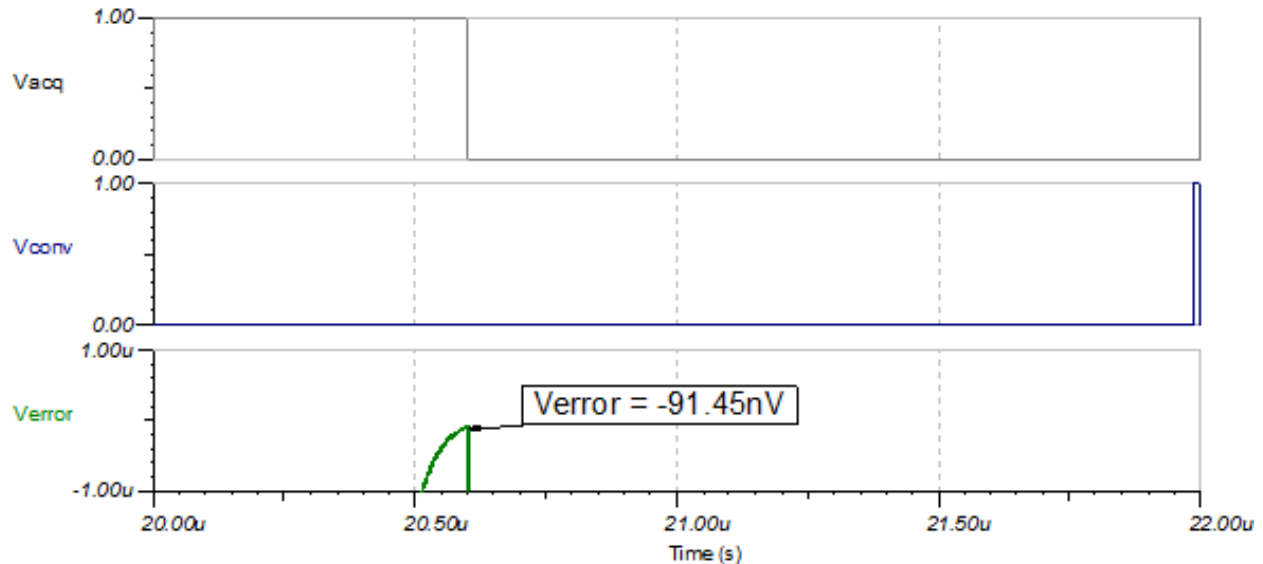

Noise Simulation

A simplified noise calculation is made here for a rough estimate. We neglect noise from the antialias filter in this calculation since it is attenuated for frequencies greater than 50kHz.

$$E_{nOPA365} = e_{nOPA365} \cdot G_{OPA} \sqrt{K_n \cdot f_c} = (7.2 \text{ nV}/\sqrt{\text{Hz}}) \cdot 1 \text{ V/V} \sqrt{1.57 \cdot 50 \text{ MHz}} = 63.8 \mu\text{V}_{\text{RMS}}$$

The value for $e_{nOPA365}$ is taken from a data sheet noise curve. Note that calculated and simulated noise values match well. Some of the discrepancy between the simulated and calculated noise is due to inaccuracy from the bandwidth of the OPA365 model. See TI Precision Labs video on [Calculating the Total Noise for ADC Systems](#) for detailed theory on noise calculations.

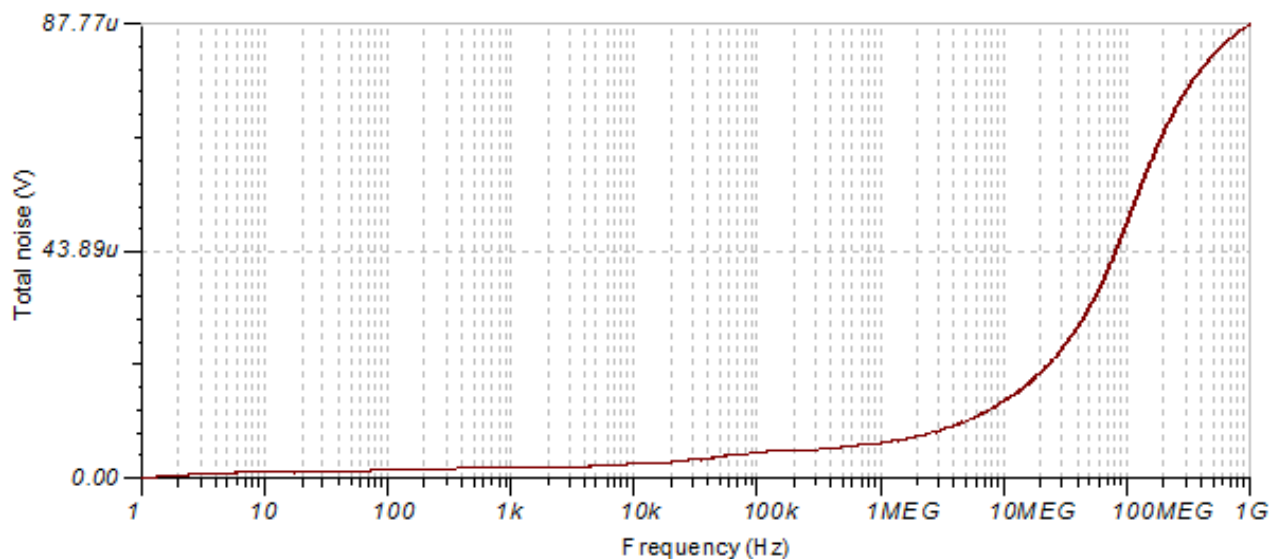

Design Featured Devices

Device	Key Features	Link	Similar Devices
ADS8319	16-bit, 500-kl, serial interface, micro-power, miniature, SAR ADC	www.ti.com/product/ads8319	www.ti.com/adcs
OPA365	50-MHz, zero-crossover, low-distortion, high CMRR, RRI/O, single-supply operational amplifier	www.ti.com/product/opa365	www.ti.com/opamp

Design References

See [Analog Engineer's Circuit Cookbooks](#) for TI's comprehensive circuit library.

Link to Key Files

Source files for this design – <http://www.ti.com/lit/zip/sbac197>.

Revision History

Revision	Date	Change
A	March 2019	Downstyle the title and changed title role to 'Data Converters'. Added link to circuit cookbook landing page.

IMPORTANT NOTICE AND DISCLAIMER

TI PROVIDES TECHNICAL AND RELIABILITY DATA (INCLUDING DATA SHEETS), DESIGN RESOURCES (INCLUDING REFERENCE DESIGNS), APPLICATION OR OTHER DESIGN ADVICE, WEB TOOLS, SAFETY INFORMATION, AND OTHER RESOURCES "AS IS" AND WITH ALL FAULTS, AND DISCLAIMS ALL WARRANTIES, EXPRESS AND IMPLIED, INCLUDING WITHOUT LIMITATION ANY IMPLIED WARRANTIES OF MERCHANTABILITY, FITNESS FOR A PARTICULAR PURPOSE OR NON-INFRINGEMENT OF THIRD PARTY INTELLECTUAL PROPERTY RIGHTS.

These resources are intended for skilled developers designing with TI products. You are solely responsible for (1) selecting the appropriate TI products for your application, (2) designing, validating and testing your application, and (3) ensuring your application meets applicable standards, and any other safety, security, regulatory or other requirements.

These resources are subject to change without notice. TI grants you permission to use these resources only for development of an application that uses the TI products described in the resource. Other reproduction and display of these resources is prohibited. No license is granted to any other TI intellectual property right or to any third party intellectual property right. TI disclaims responsibility for, and you will fully indemnify TI and its representatives against, any claims, damages, costs, losses, and liabilities arising out of your use of these resources.

TI's products are provided subject to [TI's Terms of Sale](#) or other applicable terms available either on [ti.com](#) or provided in conjunction with such TI products. TI's provision of these resources does not expand or otherwise alter TI's applicable warranties or warranty disclaimers for TI products.

TI objects to and rejects any additional or different terms you may have proposed.

Mailing Address: Texas Instruments, Post Office Box 655303, Dallas, Texas 75265
Copyright © 2021, Texas Instruments Incorporated