

# Thermal Implementation Guide for In-Package Magnetic Current Sensors



## ABSTRACT

In-package magnetic current sensors like the TMCS1100 can pass several amps of current through the leadframe. The exact amount of current that can be passed through is layout- and environment-dependent as both determine how hot the device gets for a given load. Properly measuring the device temperature is therefore critical for verifying a design. This application report covers a method for properly assessing the device temperature and provides some insight on how to improve layout.

---

## Table of Contents

1 Thermal Handling .....	2
2 Probes and Measurement Setup.....	2
3 ESD Body Diode Characterization.....	8
4 Measuring Junction Temperature.....	10
5 Measuring Case Temperature.....	11
6 Case to Junction Temperature Correlation.....	12
7 Summary.....	17

## Trademarks

All other trademarks are the property of their respective owners.

## 1 Thermal Handling

System attributes such as copper weight, copper input plane size, an added heat sink, nearby heat sources, and fans all can significantly impact thermal performance. Despite the uniqueness of any given thermal environment, by using the steps listed in this application report, one can verify how a device like the TMCS1100 thermally performs in a system. The basic steps for analysis are as follows:

1. [Probes and Measurement Setup](#)
2. [ESD Body Diode Characterization](#)
3. [Measuring Junction Temperature](#)
4. [Measuring Case Temperature](#)
5. [Case to Junction Temperature Correlation](#)

With the steps outlined, multiple layouts were measured and compared. The results of this process are given in the [Measurement Results](#) section.

## 2 Probes and Measurement Setup

To verify the thermal performance of the TMCS1100 for a particular system design, reliable and repeatable measurements must be taken. This section provides a detailed description of several of the key variables to be aware of when preparing the test setup when using a thermocouple. Following the detailed discussion of each key variable is a [summary of best practices](#) for quick reference.

### Sensor

Measuring temperature can be achieved through a few different methods that include IR camera, a fluor-optic probe, a thermocouple, temperature sensor IC, thermistor, RTD, and IR gun. Each method has its own set of advantages and challenges. For this particular app-note, K type thermocouples were used as these are standardized, ubiquitous, relatively linear, can be placed inside a 125°C oven chamber, and can easily measure up to 150°C. Other standardized thermocouples such as types E, J, N, T, R/S, and B could also be used as these also are well characterized and can easily be analyzed with thermocouple interface modules, like the USB-TC01 offered by National Instruments. Such modules allow for a simple interface that can be automated with a computer. Additionally, such modules provide a cold junction compensation circuit, which is a good alternative to soaking the cold junction of a thermocouple in ice water.

Following the selection of a thermocouple sensor, test setup details to observe include [sensor location](#), [secure sensor placement](#), [sensor contact](#), [thermal mass](#), [thermal lag](#), and [ambient temperature](#).

### Sensor Location

Probe location matters, as the part does not exhibit a uniform heat profile when the device is powered, and even less so when current is passed through the leadframe. Non-uniform heat profiles can be observed in simulations of the TMCS1100 [case thermal profile](#), [junction thermal profile](#), and [leadframe thermal profile](#). In the [leadframe thermal profile](#), you can see that for a given current the temperature is highest in the central bend, where the current encounters the greatest resistance. From this point, heat has multiple paths it can flow through the leadframe, case, and IC die to the ambient environment. Depending upon thermal resistance between the bend and the probe point as well as external heat sources/sinks, significantly different temperatures can be observed. These heat profile simulations correspond to a TMCS1100 subjected to 20 A at 25°C ambient on the [TMCS1100EVM](#). While these models are ideal and neglect several variables of influence that will be present in a bench setup, these still provide some insight into what the relative heat flow will be through the device. These heat plots indicate the difference in temperature that might be observed according to where the probe is placed.

In terms of uniformity, the die (or junction) has the most uniform profile, yet yields the challenge of not being exposed for direct measurement. The next most uniform heat gradient, based on the amount of change in relation to surface area, is the top of the case. The last and largest heat gradient is exhibited on the leadframe. As the leadframe has the greatest variation over a significantly smaller exposed surface area, we do not recommend probing on the leadframe pin due to the precision required for repeatability in measurement.

Additionally, if temperature tests are performed on the end application board, there could be complications with the thermocouple probe being at the leadframe pin voltage potential. Consequently, we recommend using a case temperature reading after an initial correlation with junction temperature.

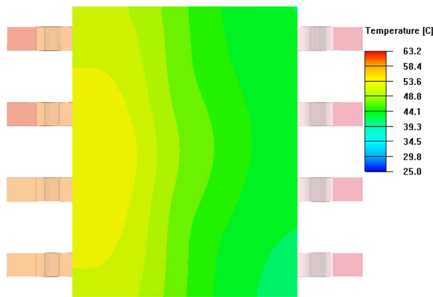

Figure 2-1. Case Thermal Profile

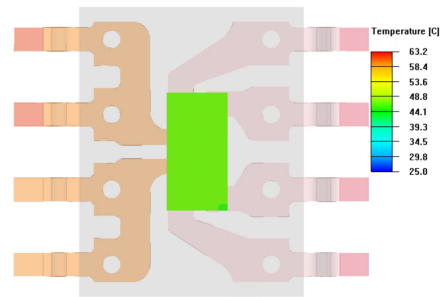

Figure 2-2. Junction Thermal Profile

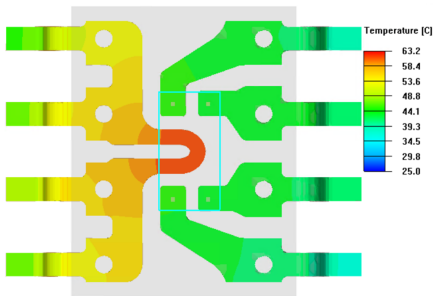

Figure 2-3. Leadframe Thermal Profile

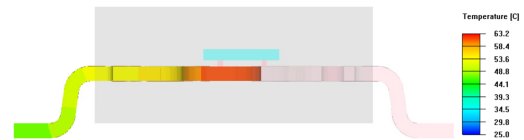

Figure 2-4. Leadframe Side Thermal Profile

### Secure Sensor Placement

Since within a generic probe region there can be a substantial thermal gradient, it is important to have repeatable, secure placement. As such, the setup used for this application report utilized a 3D printed [thermocouple fixture](#) to restrict the freedom of motion and guide the thermocouple toward the desired probe location. Additionally, this fixture provided force on the thermocouple wire such that the thermocouple maintained good contact with the surface and eliminated probe movement from board handling. When sweeping the system across temperatures in an oven, careful consideration should be given to the material used for probe fixture, as fixture melting point and thermal expansion of test setup materials can displace the probe. For some tests performed in this application report, devices were subjected to 125°C ambient. Some standard 3D printer materials have a glass transition temperature below that, which can lead to their shape changing and the measurement probe moving. Consequently, a nylon fixture was used for the 125°C ambient measurements.

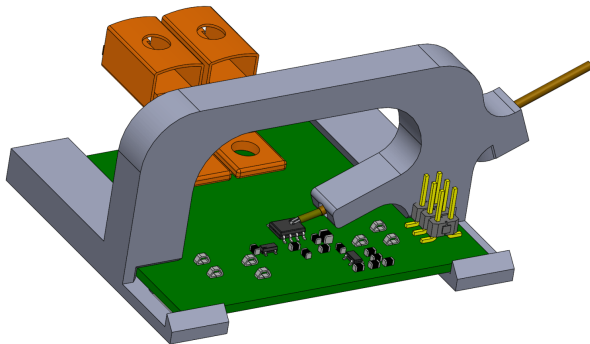

Figure 2-5. Thermocouple Fixture

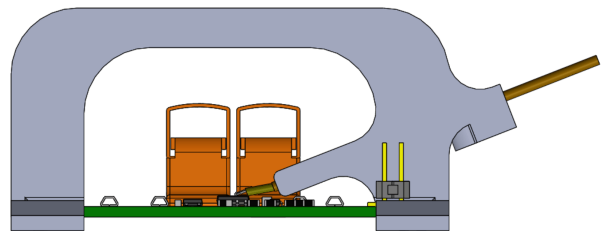
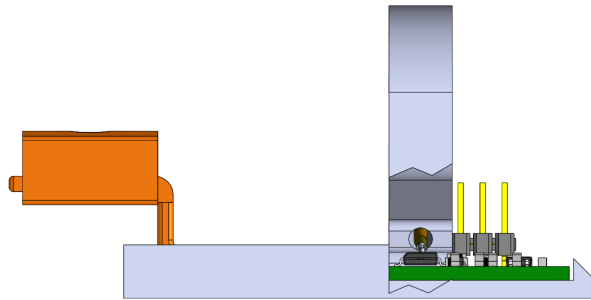
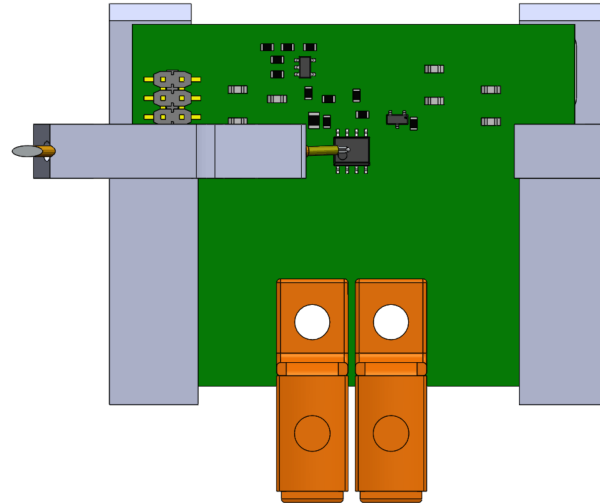

Figure 2-6. Thermocouple Fixture - Front



**Figure 2-7. Thermocouple Fixture - Left**



**Figure 2-8. Thermocouple Fixture - Top**

### Sensor Contact

Just as crucial as probe location and secure placement is probe surface contact. If improperly addressed, bad surface contact can lead to unwanted thermal resistance between the probe and measurement target location. Along with forcing the probe onto the case, we recommend using thermal paste to provide a good thermal conductive bridge between the surface of the thermocouple and the surface of the sense location. Ideally, the thermal paste quantity should not extend much beyond the circumference of the thermocouple joint as shown in the [Thermal Paste Diagram](#), as the thermal paste can influence thermal performance. We recommend using a micro-syringe to provide a controlled quantity to the sense location.

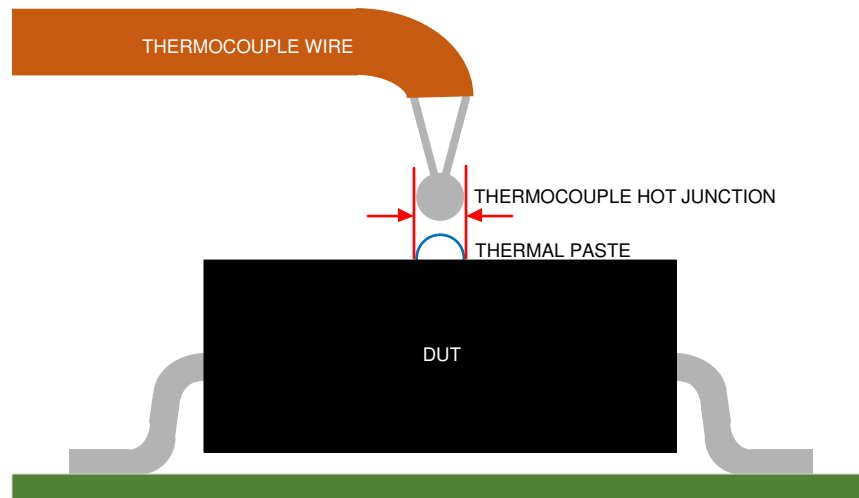

DUT = Device Under Test

**Figure 2-9. Thermal Paste Diagram**

### Thermal Mass

Part of the reason thermal paste should be minimized is that it provides some thermal mass. Any thermal mass connected to the package can influence the thermal behavior. Large globs of thermal paste provide a thermally conductive mass with more surface area exposed to air flow that increases convective heat loss. Aside from thermal paste, large masses like a thermocouple lead or load input that channel out of the test chamber into a colder ambient environment sink more heat away, especially if the mass has a good thermally conductive

interface to the device. Using [Equation 1](#) and [Figure 2-10](#), the heat conducted through the channel can be extrapolated. Lower gauge wire corresponding to thicker wire has a larger cross-sectional area. According to the equation, larger cross-sectional area increases  $Q$ , the amount of heat flowing. Also according to the equation, a large temperature delta between the thermocouple hot junction and some other point of the thermocouple, such as outside of an oven, will increase heat flow, especially as the distance between those two points is shortened. Therefore, the size of the thermocouple leads and junction should be minimized and the length of probe wire in the controlled temperature chamber should be maximized.

$$\frac{Q}{\Delta t} = -kA \frac{\Delta T}{\Delta x} \quad (1)$$

where

- $Q$  is the amount of heat conducting through the channel
- $\Delta t$  is the time interval of interest for a given conduction channel
- $A$  is the cross-sectional area of the channel
- $\Delta T$  is the temperature difference between both ends of the channel
- $\Delta x$  is the length of the channel.

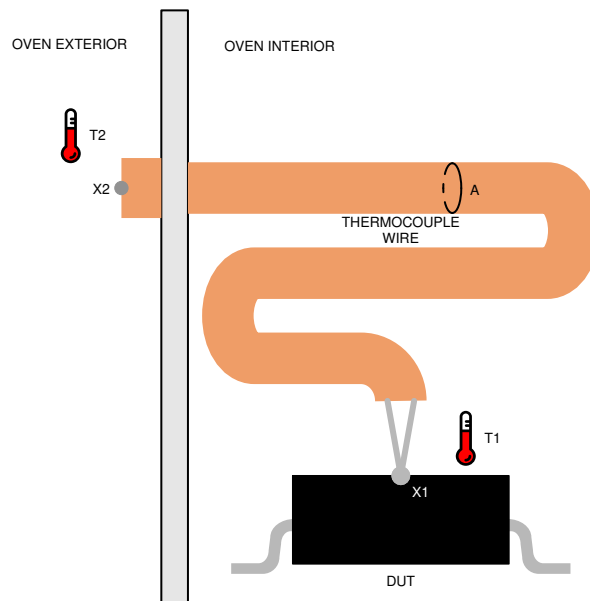

**Figure 2-10. Thermocouple Thermal Conduction Coefficients**

### Thermal Lag

After setting up the probes for measurement, there is still a run-time issue to consider, which can be broadly related to thermal lag and thermal equilibrium. Relative initial temperature, external heat sources, distance, run-time, and thermal resistance between the heat source and the probe location will all influence what temperature is observed at a particular probe location. In our measurements, we typically step from no load to several amps of current in a controlled ambient environment with no significant adjacent heat sources. In this scenario, probes placed on the device have exuded an initial steep rise in temperature that then gradually levels off as the rate of heat entering that location balances with the rate of heat leaving that location. When the temperature no longer increases after the current has been set, that location has reached thermal equilibrium. [Figure 2-11](#) illustrates how the temperature lags behind the current and can take a significant amount of time to reach thermal equilibrium. With good ambient regulation, the tests in this application report indicate thermal equilibrium may be reached in about three minutes for a continuous current load.

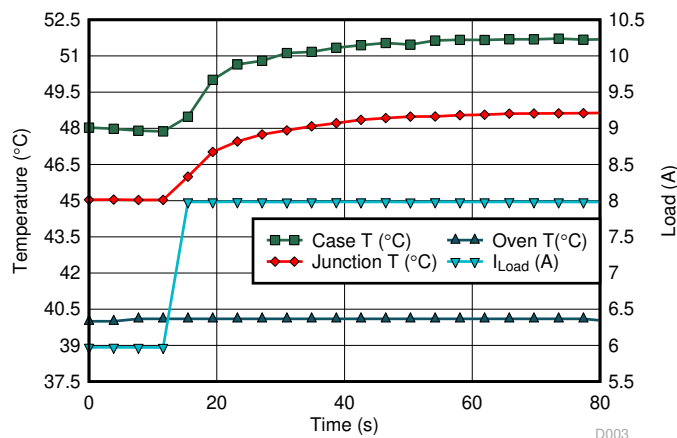

Figure 2-11. Temperature and Load vs Time

### Ambient Temperature

As alluded to in the thermal lag section, ambient temperature can influence results if not tightly monitored and regulated. This can be readily observed at lower currents and lower ambient temperatures. If the test board is left in a loosely temperature controlled chamber like a typical lab, then measurements may exhibit periodic 5°C swings due to the building HVAC system. Alternatively if the device is housed in any unregulated enclosure to shield from the wind chill of lab equipment exhaust fans or the building HVAC system, ambient temperature drift within the enclosure may make the device never seem to reach thermal equilibrium. Even within a controlled chamber there is expected to be some temperature gradient in which the immediate air space surrounding the device may be at a different temperature than the oven sensor, especially on a test board involving other parts dissipating heat. We recommend having at least one ambient temperature sensor nearby when assessing device thermal performance.

### Summary of Best Practices

The previous discussion on how best to set up a thermocouple for case measurements is summarized in [Figure 2-12](#) through [Figure 2-21](#). The left column of images illustrate bad setup examples, while the right column shows good setup examples.

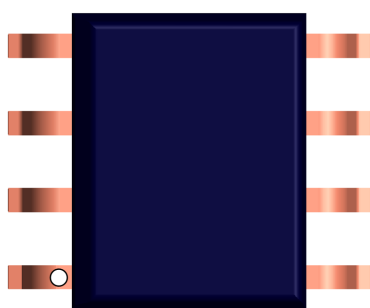

Figure 2-12. Probe on Pin

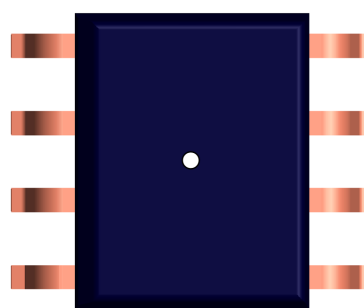

Figure 2-13. Probe on Case

- Probing on the case requires less precision than probing on the pin, and is therefore more repeatable.

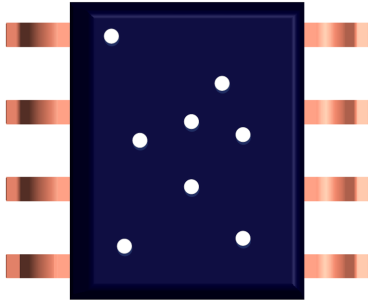

Figure 2-14. Low Precision

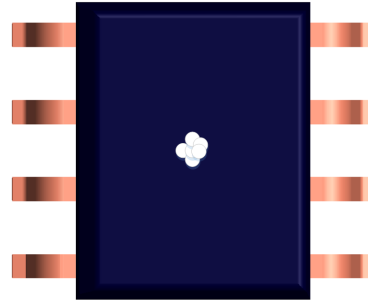

Figure 2-15. High Precision

- The package does exhibit a thermal gradient, so tighter precision will provide more consistent results.

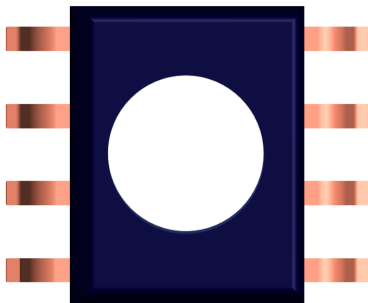

Figure 2-16. Too Much Thermal Paste

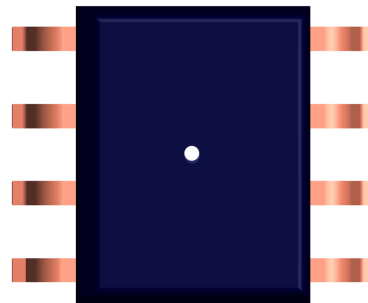

Figure 2-17. Enough Thermal Paste

- While thermal paste is necessary for a good connection between the case and thermocouple, it does influence the thermal behavior and should be minimized if it is not expected to be on the final manufactured board.

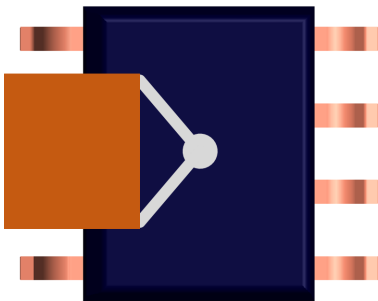

Figure 2-18. Large Thermocouple

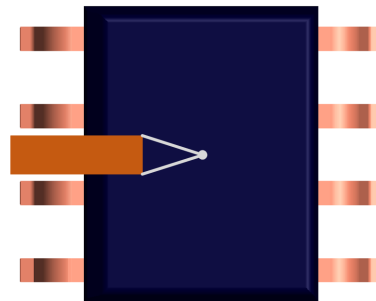
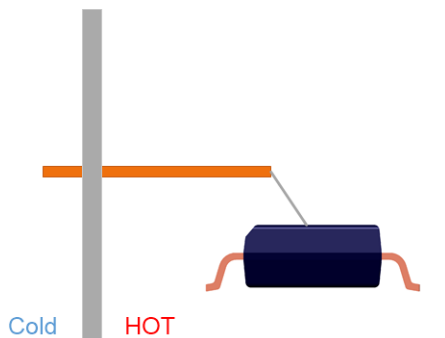
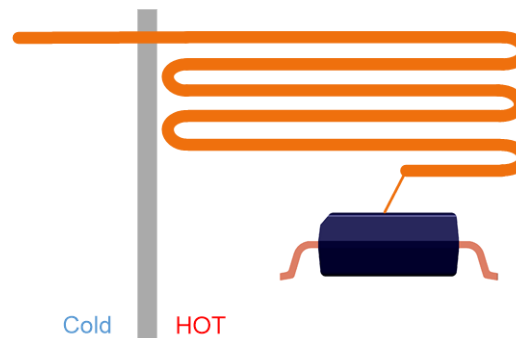

Figure 2-19. Small Thermocouple

- Smaller probes channel less heat away from the case and therefore provide a better indication of thermal performance if the probe was not present.



**Figure 2-20. Short Lead in Chamber**



**Figure 2-21. Long Lead in Chamber**

- A longer thermocouple lead in the chamber provides more thermocouple mass at the desired ambient temperature and increases the thermal resistance thereby restricting heatflow to the colder outer chamber.

### 3 ESD Body Diode Characterization

Measuring die temperature is achieved by forward biasing one of the device's internal ESD diodes while the low voltage side is not powered. The voltage seen across the diode changes according to cumulative temperature from heat sources internal and external to the device. By forcing the device to a known temperature without passing a load through the device, the diode voltage to temperature relationship can be determined.

Each diode shown in [Figure 3-1](#) can individually be forward biased by forcing current from a source measure unit (SMU) (+) terminal into the anode, through to the respective cathode, and out to the SMU (-) terminal. For this application report, the diode forward biased from GND to VOUT was used, while VS and VREF were left floating. To force current, a Keithley 2420 source meter was used. To use the diode for temperature measurements, the forced current should be sufficient for the voltage across the ESD diode to reach the forward voltage, but not exceed the device max quiescent current of 6 mA. Consequently 1 mA was used for the tests in this report as the current level satisfies both conditions. To characterize the device across temperature an oven or bath can be used. For the diodes characterized in this report, multiple TMCS1100 devices were placed in a Harte Scientific oil bath and swept across temperature with measurements at 25°C, 75°C, 100°C, and 125°C.

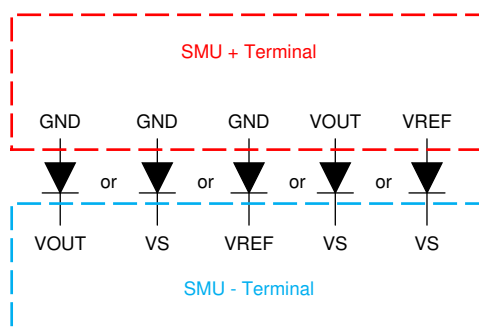

**Figure 3-1. TMCS1100 ESD Diodes**



From the temperature sweeps, 12 data curves were collected. From those curves an average curve shown in Figure 3-2 was derived with corresponding best fit Equation 2. Comparing the average to the actual measured data indicates that there will be some error in calculation when using the equation as shown in Figure 3-3. While the equation provides  $\pm 2^{\circ}\text{C}$  tolerance for the characterized device diodes in this application report, different forcing currents and different device lots may be better characterized by another equation. Therefore, if precision is desired, we recommend characterizing the diodes for your devices.

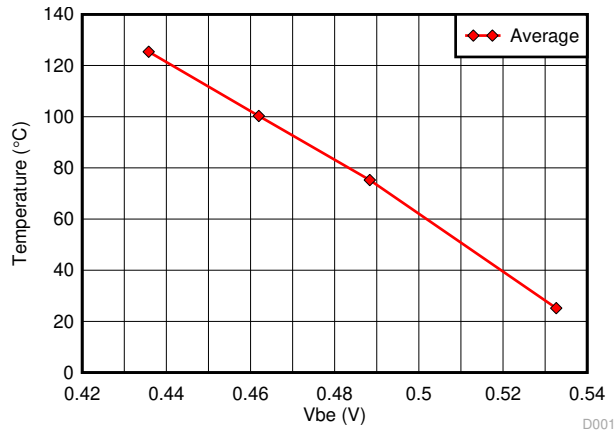

**Figure 3-2. Diode Voltage Versus Temperature**

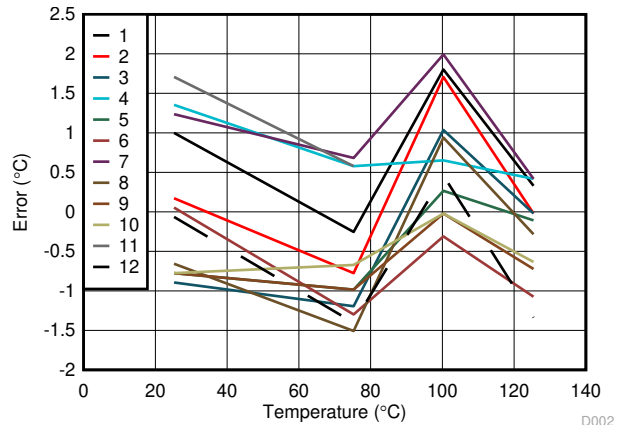

**Figure 3-3. Temperature Error**

$$\text{Temperature} = -1581.2 \times \text{Vbe}^2 + 500.92 \times \text{Vbe} + 207.112 \quad (2)$$

**Step Summary**

- Apply SMU positive terminal to device ground pin and SMU negative terminal to device Vout pin.
- Immerse devices in a temperature controllable chamber.
- Source 1mA of current to GND pin from source meter.
- Measure voltage across body diode, in this case GND to VOUT.
- Sweep DUT through series of temperatures.
- Take average of each temperature step and plot.
- Determine best fit equation for plotted line.

## 4 Measuring Junction Temperature

The absolute maximum ratings table specifically states that the upper bound for junction temperature is 150°C and further states that "stresses beyond those listed under Absolute Maximum Ratings may cause permanent damage to the device." Consequently, knowing the junction temperature is important for verifying whether the device will survive a given set of operating conditions. As junction refers to the die encased in the device package, thereby shielded from a typical optical or physical probe, this presents a challenge. Fortunately, by characterizing one of the device ESD diodes covered in the previous section, the junction temperature can be determined for a given load current.

The method for measuring junction temperature for a given load is very similar to the method used for characterizing one of the internal ESD diodes. The key difference is that relating diode voltage to temperature with Equation 2 can now be leveraged to determine what temperature the junction experiences for a given load at a given ambient temperature. Figure 4-1 illustrates one possible test setup, in which heat generated from passing load current through the leadframe is monitored by the ESD diode forward biased from the GND to VOUT pins.

### Step Summary

- Apply SMU positive terminal to device ground pin and SMU negative terminal to device VOUT pin.
- Source 1 mA of current to GND pin from source meter.
- Measure voltage across body diode, in this case GND to VOUT.
- Sweep DUT through series of load current levels. At minimum measure two current levels.
- Use the equation derived from diode characterization to determine load to junction temperature relationship.

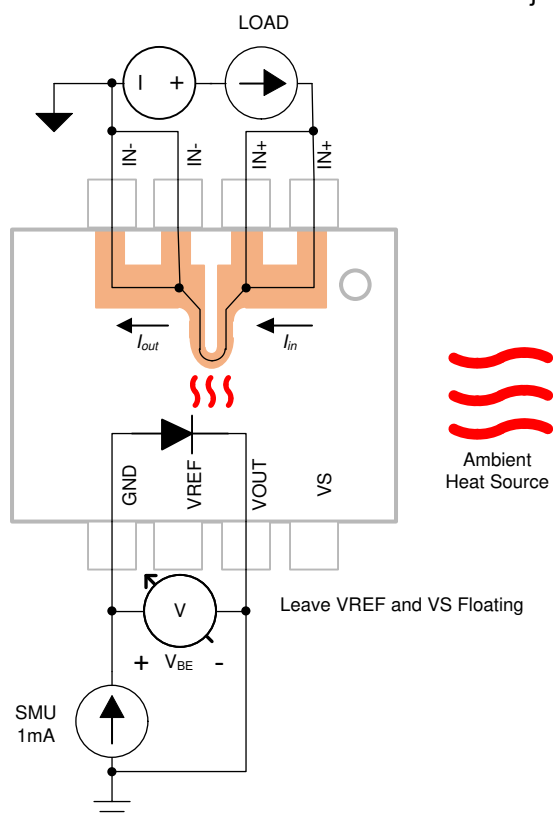

**Figure 4-1. Junction Measurement Schematic**

## 5 Measuring Case Temperature

One common method used for approximating junction temperature is the case temperature. While the case temperature provides information that can be used to determine the junction temperature, its temperature value is not equal to the junction temperature. All convective and conductive heat equation variables will have some impact on how close the case temperature is to the junction temperature. For this application report multiple points were taken to derive the relationship. While such granularity may not be possible for your setup, we believe you need at least two current load points per ambient temperature condition to confidently relate case temperature to junction temperature.

Figure 5-1 illustrates one possible test setup for measuring case temperature. For this application report the case top was chosen as the surface for the case thermocouple as it readily accessible on the EVM layout. In particular, the probe was positioned on the top such that the thermocouple hot joint was roughly positioned over the bend in the leadframe, and thereby the shortest distance from the primary origin of heat in the device. This was held in place by the fixture shown in Figure 2-5 and the thermal connection was enhanced with thermal paste.

### Step Summary

- Choose a well characterized temperature sensor, such as a thermocouple with thin leads.
- Use thermal paste to ensure good thermal connection between TMCS1100 and temperature sensor.
- Secure temperature sensor with non-conductive, thermally robust fixture that provides repeatable placement.
- Sweep DUT through series of load current levels. At minimum measure two current levels.

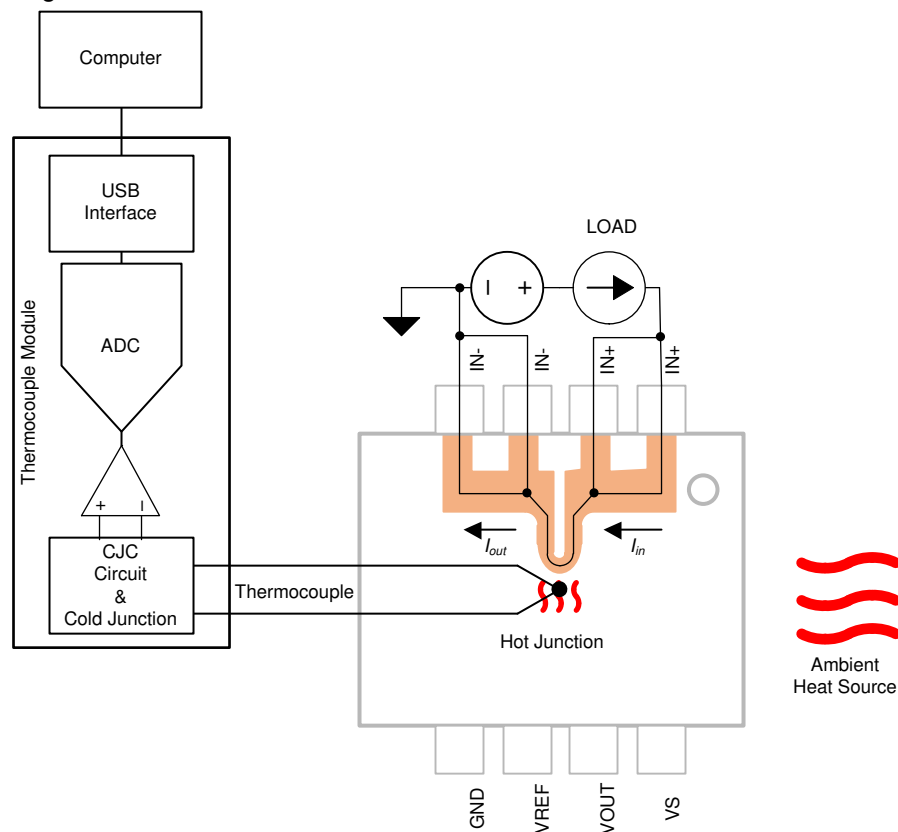

\*Hot Junction & Cold Junction correspond to thermocouple  
 \*Junction by itself refers to device silicon die

**Figure 5-1. Case Measurement Schematic**

## 6 Case to Junction Temperature Correlation

Through the aforementioned measurement technique, the maximum load for a cutoff junction temperature of 135°C was found for a few different PCB layouts, shown in [Figure 6-1](#) through [Figure 6-8](#). One layout is the [TMCS1100EVM](#), which is optimized for large loads in a hot environment. The EVM layout has large input planes, 3 oz. copper layers, and copper layers on both the top and bottom layers of the board. The other layouts are a variation of the EVM layout with 1 or more thermal optimization attributes removed. The board names and layout variations are described in [Table 6-1](#).

**Table 6-1. Sample Layouts and Thermal Optimization Attributes**

Layout	Copper Weight	Top Copper	Bottom Copper	Large Input Load Planes
EVM (E1)	3 oz.	x	x	x
L1	1 oz.	x	x	x
L2	1 oz.	x		x
L3	1 oz.	x		

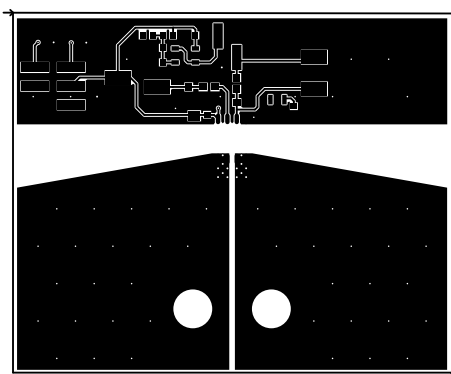

**Figure 6-1. EVM (E1) Layout Top Layer**

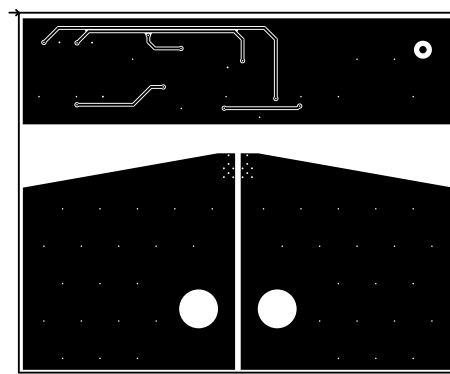

**Figure 6-2. EVM (E1) Layout Bottom Layer**

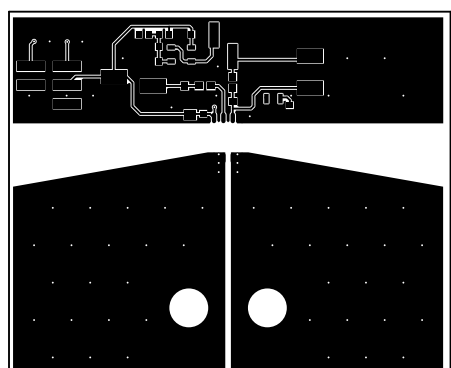

**Figure 6-3. L1 Layout Top Layer**

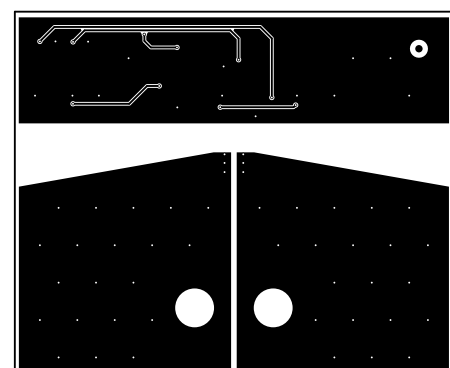

**Figure 6-4. L1 Layout Bottom Layer**

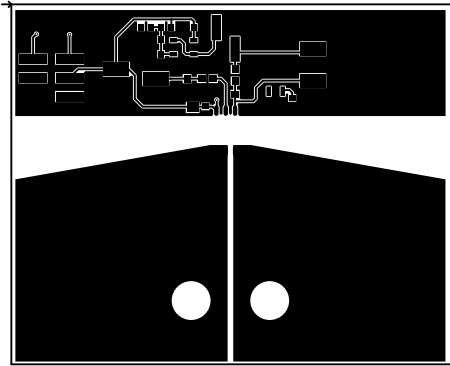

Figure 6-5. L2 Layout Top Layer

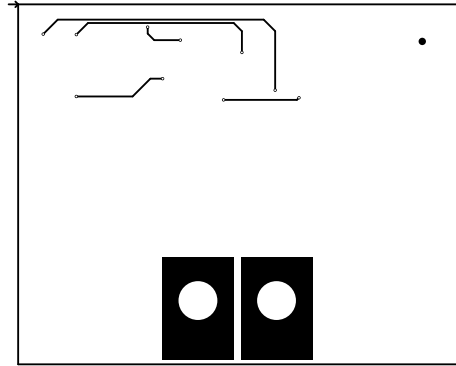

Figure 6-6. L2 Layout Bottom Layer

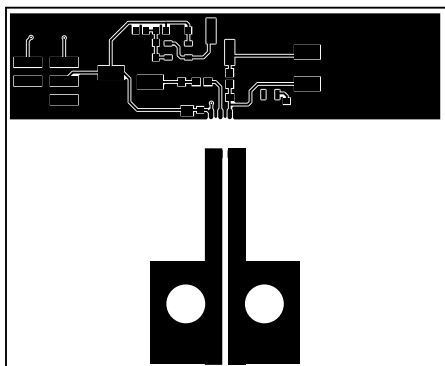

Figure 6-7. L3 Layout Top Layer

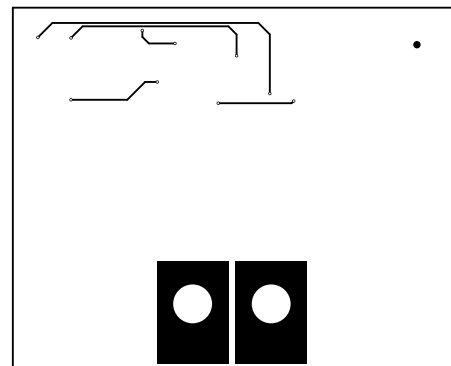

Figure 6-8. L3 Layout Bottom Layer

### Measurement Results

Case and junction measurement data was collected at three different ambient temperatures: 40°C, 85°C, and 125°C. The impact of each tier of optimization for the various layouts is observed in Figure 6-9 through Figure 6-14. The plotted data shows the measured temperature with respect to load current. The thermal handling amongst the layouts improves from left to right within each plot, where the rightmost plotted line in each figure indicates the layout that has the least temperature change per current step and can handle the most current before the junction reaches 135°C. Regardless of measurement technique, the layouts ranked from most thermally robust to least are the EVM (E1), L1, L2, and L3.

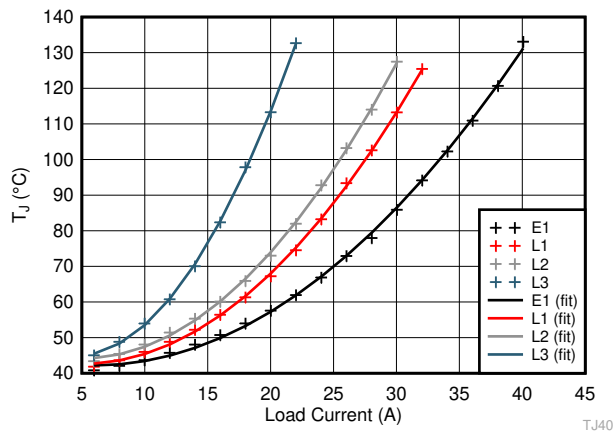

Figure 6-9. 40°C Ambient Junction Measurements

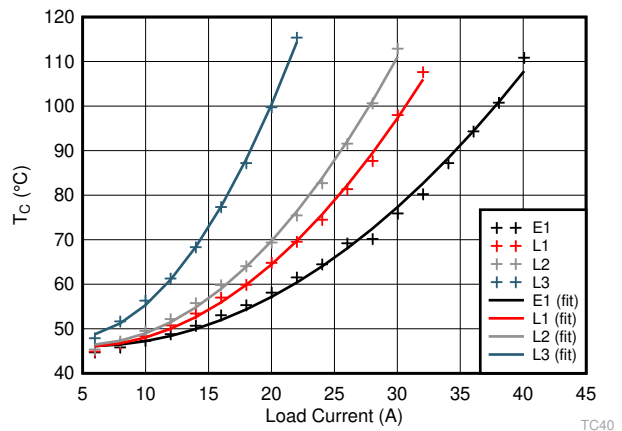

Figure 6-10. 40°C Ambient Case Measurements

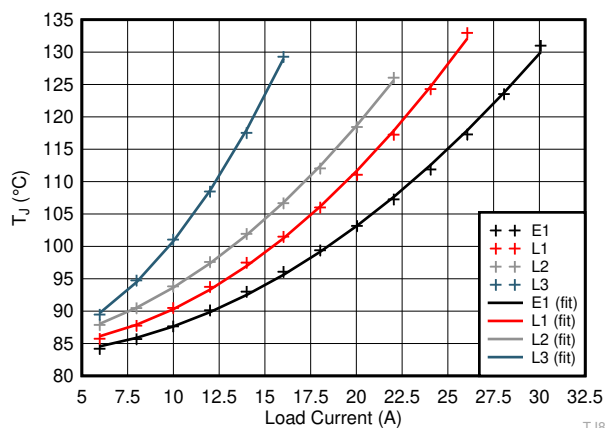

Figure 6-11. 85°C Ambient Junction Measurements

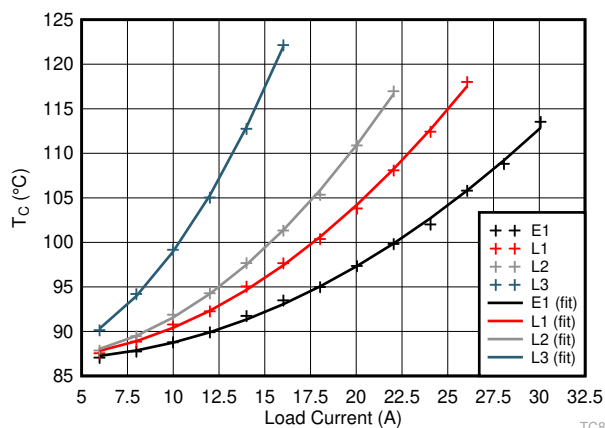

Figure 6-12. 85°C Ambient Case Measurements

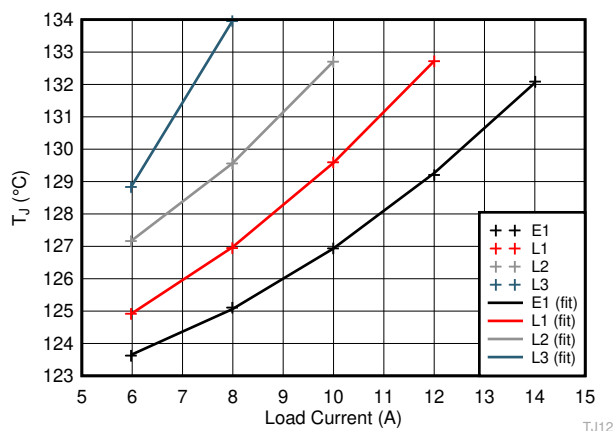

Figure 6-13. 125°C Ambient Junction Measurements

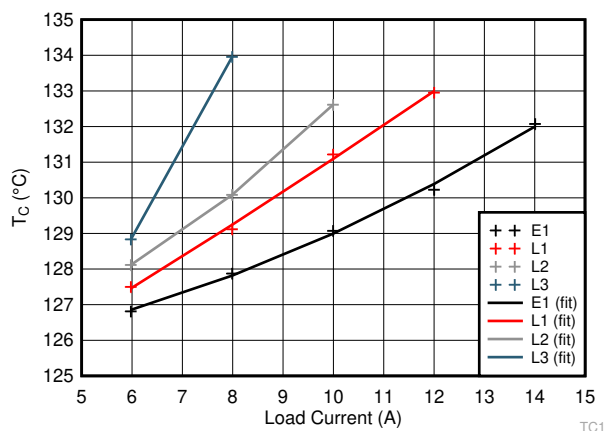

Figure 6-14. 125°C Ambient Case Measurements

### Key Observations

- More copper weight (trace thickness) and wider traces sink more heat and allow larger current loads.
- Higher ambient temperature reduces maximum acceptable load.
- The load current-to-temperature relationship is non-linear (multi-order polynomial), and if measurements are done properly should exhibit a trend that can be curve fitted.
- Junction temperature does not equal case temperature.

### Correlating Case to Junction

When validating a system there may not be the option to take a junction measurement, as that would require the TMCS1100 to be powered off and its ground to be isolated from the system ground in order to bias one of the diodes. Consequently, a case measurement may be preferred. This is possible provided that at least a few prior junction measurements are taken to determine the case-to-junction relationship. If using a thermocouple for case measurement as in this application report, attention to the details listed in the beginning of this application report will determine the relationship between case and junction. Overlooking these details may lead to inconsistent case measurements that are further from the junction temperature.

The previous figures indicate that the measured temperature relationship to current is non-linear and different per layout and given ambient temperature. They also show that case and junction temperature measurements exhibit different relationships to load current given the same load and ambient temperature. Despite these inconveniences, there still is a convenient relationship between junction temperature and case temperature. By

plotting junction temperature versus case temperature with the ambient offset removed ( $T_J - T_A$  versus  $T_C - T_A$ ), a relatively linear relationship can be observed as shown in [Figure 6-15](#). By removing the ambient temperature offset, the data for all layouts over all temperatures converge onto roughly the same origin with the same general trend. To determine the line that describes the trend, a least sum squares approximation can be done on all of the datapoints or on the trend lines of each layout and temperature dataset. The results for each approximation method will be different, but the deviation between methods for the presented data is within 3°C.

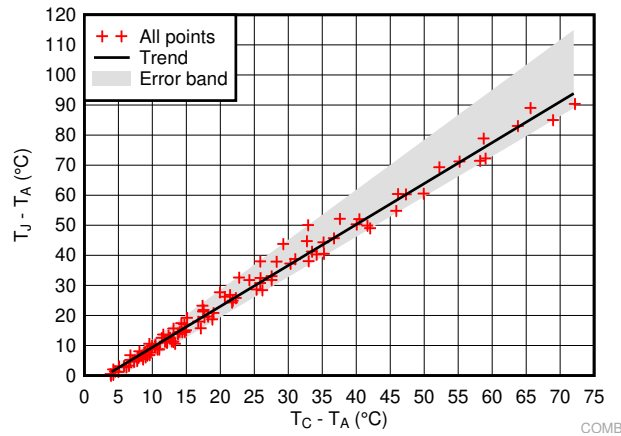

**Figure 6-15.  $T_J - T_A$  vs  $T_C - T_A$**

[Equation 3](#) provides the best approximation of all datapoints:

$$T_J - T_A = 1.31 \times (T_C - T_A) - 2.8 \quad (3)$$

Using this equation, the junction temperature can now be determined based upon a case measurement and an ambient temperature (preferably taken near the device case). For instance, if the ambient temperature is 76°C and the load is 18.4A, the approximated junction temperature can be calculated as follows:

1. Take the case measurement, 90.47°C.
2. Subtract ambient measurement (76°C) from case measurement (90.47 °C) to get  $T_C - T_A = 14.47$  °C.
3. Substitute the remainder (14.47°C) into [Equation 3](#) to get  $T_J - T_A = 16.16$ °C.
4. Add the ambient temperature to the solution to get the junction temperature of  $T_J = 92.16$ °C.

According to a bench test check, junction temperature was measured to be 93.16°C, thereby making the calculation only 1°C off from the measurement.

One important caveat to emphasize is the previous formula holds across multiple layouts and multiple ambient temperatures so long as the probe is precisely placed on the case. However, if a heat sink is placed on the case, thereby displacing the case probe to a trough in the heat sink, the relationship is expected to change quite dramatically. This can be observed in [Figure 6-16](#).

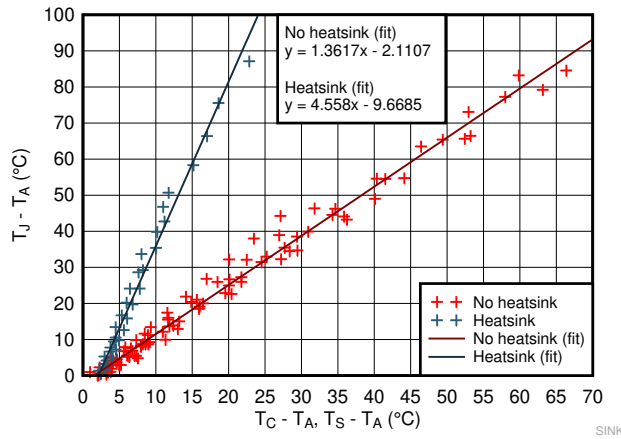

Figure 6-16. Heat Sink vs No Heat Sink

### Approximating Maximum Load

Through correlating case to junction, it is also possible to extrapolate the maximum load the device can handle for a given layout at a given ambient temperature. If sufficient case measurement points are taken and converted into junction temperature points, a curve can be fitted to predict at what load the device may fail. For instance, the case measurement data for the EVM at 40°C found in [Figure 6-10](#) can be used to generate junction calculations with respect to load. Based off the 40°C case measurements,  $T_J$  (calc.) in [Figure 6-17](#) was generated along with a second-order polynomial best fit equation. Through such an equation, a maximum load where  $T_J$  equals 150°C can be estimated. For this example, the maximum load based off case measurements and the corresponding junction calculations is 45 A, while the max load based off of measured junction data is estimated to be around 43.5 A. The estimate based on calculations is therefore 3.5% higher than the estimate based upon junction measurements. With more data points we expect that the percent error would decrease.

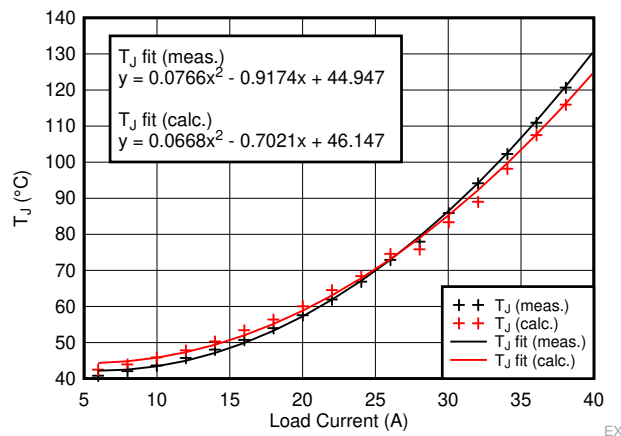

Figure 6-17. Calculated vs Measured  $T_J$



## 7 Summary

This application note showed a method for assessing thermal performance of in-package magnetic current sensors. The first step of the method entailed sweeping a TMCS1100 with no load across temperature and determining the junction voltage to junction temperature relationship. The second step required at least two junction and case measurements for different loads be obtained to determine the junction and case temperature relationship when the device is powered off and isolated from the system supply and ground. The measurement data showed that the relationship is linear and could subsequently be used to calculate junction temperatures based upon case temperatures. This method relied on case measurements through a thermocouple. This application report discussed several of the subtle setup variables that can influence the accuracy of the thermocouple measurement. These variables were important for procuring the results observed in this report and will be important for any similar thermal assessment of the TMCS1100 involving a thermocouple.

## IMPORTANT NOTICE AND DISCLAIMER

TI PROVIDES TECHNICAL AND RELIABILITY DATA (INCLUDING DATA SHEETS), DESIGN RESOURCES (INCLUDING REFERENCE DESIGNS), APPLICATION OR OTHER DESIGN ADVICE, WEB TOOLS, SAFETY INFORMATION, AND OTHER RESOURCES "AS IS" AND WITH ALL FAULTS, AND DISCLAIMS ALL WARRANTIES, EXPRESS AND IMPLIED, INCLUDING WITHOUT LIMITATION ANY IMPLIED WARRANTIES OF MERCHANTABILITY, FITNESS FOR A PARTICULAR PURPOSE OR NON-INFRINGEMENT OF THIRD PARTY INTELLECTUAL PROPERTY RIGHTS.

These resources are intended for skilled developers designing with TI products. You are solely responsible for (1) selecting the appropriate TI products for your application, (2) designing, validating and testing your application, and (3) ensuring your application meets applicable standards, and any other safety, security, regulatory or other requirements.

These resources are subject to change without notice. TI grants you permission to use these resources only for development of an application that uses the TI products described in the resource. Other reproduction and display of these resources is prohibited. No license is granted to any other TI intellectual property right or to any third party intellectual property right. TI disclaims responsibility for, and you will fully indemnify TI and its representatives against, any claims, damages, costs, losses, and liabilities arising out of your use of these resources.

TI's products are provided subject to [TI's Terms of Sale](#) or other applicable terms available either on [ti.com](http://ti.com) or provided in conjunction with such TI products. TI's provision of these resources does not expand or otherwise alter TI's applicable warranties or warranty disclaimers for TI products.

TI objects to and rejects any additional or different terms you may have proposed.

Mailing Address: Texas Instruments, Post Office Box 655303, Dallas, Texas 75265  
Copyright © 2022, Texas Instruments Incorporated