



Single-Supply, Auto-Zero Sensor Amplifier with Programmable Gain and Offset

 Check for Samples: [PGA308](#)

FEATURES

- Digital Calibration for Bridge Sensors
- Offset Select: Coarse and Fine
- Gain Select: Coarse and Fine
- Bridge Fault Monitor
- Input Mux for Lead Swap
- Over/Under Scale Limits
- D_{OUT}/V_{OUT} Clamp Function
- Seven Banks OTP Memory
- One-Wire Digital UART Interface
- Operating Voltage: +2.7V to +5.5V
- Temperature Range: -40°C to $+125^{\circ}\text{C}$
- MSOP-10 and 3mm x 4mm DFN-10 Packages

APPLICATIONS

- Bridge Sensors
- Remote 4-20mA Transmitters
- Strain, Load, Weigh Scales
- Automotive Sensors

EVALUATION TOOLS

- **PGA308EVM (Hardware and Software)**
 - Calibration and Configuration
 - Sensor Emulation

DESCRIPTION

The PGA308 is a programmable analog sensor signal conditioner. The analog signal path amplifies the sensor signal and provides digital calibration for offset and gain. Calibration is done via the 1W pin, a digital One-Wire, UART-compatible interface. For three-terminal sensor modules, 1W may be connected to V_{OUT} and the assembly programmed through the V_{OUT} pin. Gain and offset calibration parameters are stored onboard in seven banks of one-time programmable (OTP) memory. The power-on reset (POR) OTP bank may be programmed a total of four times.

The all-analog signal path contains a 2x2 input multiplexer (mux) to allow electronic sensor lead swapping, a coarse offset adjust, an auto-zero programmable gain instrumentation amplifier (PGA), a fine gain adjust, a fine offset adjust, and a programmable gain output amplifier. Fault monitor circuitry detects and signals sensor burnout, overload, and system fault conditions. Over/under-scale limits provide additional means for system level diagnostics. The dual-use D_{OUT}/V_{CLAMP} pin can be used as a programmable digital output or as a V_{OUT} over-voltage clamp.

For detailed application information, see the [PGA308 User's Guide \(SBOU069\)](#) available for download at www.ti.com.

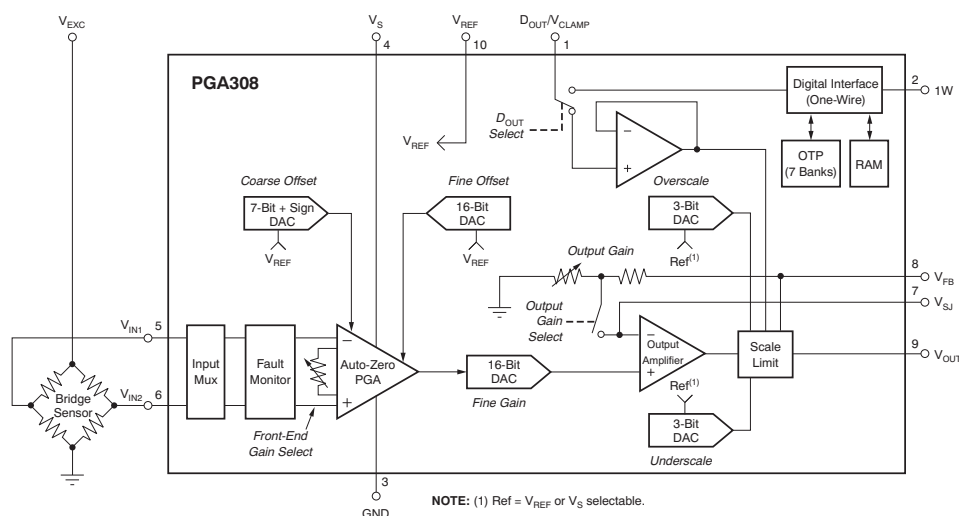

Please be aware that an important notice concerning availability, standard warranty, and use in critical applications of Texas Instruments semiconductor products and disclaimers thereto appears at the end of this data sheet.

All trademarks are the property of their respective owners.



This integrated circuit can be damaged by ESD. Texas Instruments recommends that all integrated circuits be handled with appropriate precautions. Failure to observe proper handling and installation procedures can cause damage.

ESD damage can range from subtle performance degradation to complete device failure. Precision integrated circuits may be more susceptible to damage because very small parametric changes could cause the device not to meet its published specifications.

PACKAGE/ORDERING INFORMATION⁽¹⁾

PRODUCT	PACKAGE-LEAD	PACKAGE DESIGNATOR	PACKAGE MARKING
PGA308	MSOP-10	DGS	P30A
	3mm x 4mm DFN-10	DRK	P30B

(1) For the most current package and ordering information see the Package Option Addendum at the end of this document, or see the TI web site at www.ti.com.

ABSOLUTE MAXIMUM RATINGS⁽¹⁾

Over operating free-air temperature range, unless otherwise noted.

PARAMETER		PGA308	UNIT
Supply Voltage, V_S		+5.5	V
D_{OUT}/V_{CLAMP} Output Current Limit		± 10	mA
Pin Protection	Input Current	-10 to +10	mA
	$V_{IN1}, V_{IN2}, V_{REF}, 1W, D_{OUT}/V_{CLAMP}, V_{SJ}$ ⁽²⁾	GND - 0.3 to $V_S + 0.3$	V
	V_{FB} Terminal Voltage	-30 to 30	V
	V_{FB} Terminal Current	-10 to 10	mA
	V_{OUT}	-160 to 160	mA
Operating Temperature Range		-40 to +150	°C
Storage Temperature Range		-55 to +150	°C
Junction Temperature		+165	°C
ESD Ratings	Human Body Model (HBM)	2000	V

- (1) Stresses above these ratings may cause permanent damage. Exposure to absolute maximum conditions for extended periods may degrade device reliability. These are stress ratings only, and functional operation of the device at these or any other conditions beyond those specified is not implied.
- (2) Terminals are diode-clamped to the power-supply rails, V_S and GND. Limit current to 10mA or less.

ELECTRICAL CHARACTERISTICS

Boldface limits apply over the specified temperature range, $T_A = -40^{\circ}\text{C}$ to $+125^{\circ}\text{C}$.

At $T_A = +25^{\circ}\text{C}$, $V_S = +5\text{V}$, $\text{GND} = 0\text{V}$, $D_{\text{OUT}}/V_{\text{CLAMP}} = +5\text{V}$, and $V_{\text{REF}} = +5\text{V}$, unless otherwise noted.

PARAMETER	CONDITIONS	PGA308			UNIT
		MIN	TYP	MAX	
$V_{\text{OUT}}/V_{\text{IN}}$ Differential Signal Gains ⁽¹⁾ (Front-End PGA + Output Amplifier)	Front-End PGA gains (G_F): 4, 6, 8, 12, 16, 32, 64, 100, 200, 400, 480, 600, 800, 960, 1200, 1600 Output Amplifier gains: 2, 2.4, 3, 3.6, 4, 4.5, 6 Fine Gain Adjust = 0.33 to 1	2.67		9600	V/V
$V_{\text{OUT}}/V_{\text{IN}}$ Slew Rate (Front-End PGA + Output Amplifier)	CMP_SEL [CFG1 register] = 0		0.6		V/ μs
	CMP_SEL [CFG1 register] = 1		0.3		V/ μs
$V_{\text{OUT}}/V_{\text{IN}}$ Settling Time (0.01%FSR) (Front-End PGA + Output Amplifier)	$V_{\text{OUT}}/V_{\text{IN}}$ differential gain = 8, $V_{\text{OUT}} = +0.5\text{V}$ to $+4.5\text{V}$ step, comp off, no capacitive load		13		μs
	$V_{\text{OUT}}/V_{\text{IN}}$ differential gain = 200, $V_{\text{OUT}} = +0.5\text{V}$ to $+4.5\text{V}$ step, comp off, no capacitive load		15		μs
External Sensor Output Sensitivity ⁽²⁾	$V_S = V_{\text{REF}} = V_{\text{CLAMP}} = +5\text{V}$	0.08		296	mV/V
FRONT-END PGA					
Auto-Zero Internal Frequency			40		kHz
Offset Voltage (RTI) ⁽³⁾ vs Temperature vs Supply Voltage, V_S vs Common-Mode Voltage	Coarse Offset Adjust disabled		± 5	± 40	μV
	Coarse Offset Adjust disabled		± 0.2		$\mu\text{V}/^{\circ}\text{C}$
	Coarse Offset Adjust disabled		$2 + 150/G_F$	$10 + 1000/G_F$	$\mu\text{V}/\text{V}$
	$G_F = \text{Front-End PGA gain, Coarse Offset Adjust disabled}$		$1 + 250/G_F$	$10 + 2000/G_F$	$\mu\text{V}/\text{V}$
Offset Voltage Programming Range (RTI) ⁽³⁾ vs Temperature vs Supply Voltage, V_S vs Common-Mode Voltage	Coarse Offset Adjust enabled, Coarse Offset Adjust controls offset	-100		100	mV
	Coarse Offset Adjust enabled		± 0.2		$\mu\text{V}/^{\circ}\text{C}$
	Coarse Offset Adjust enabled		$2 + 150/G_F$		$\mu\text{V}/\text{V}$
	$G_F = \text{Front-End PGA gain, Coarse Offset Adjust enabled}$		$1 + 250/G_F$		$\mu\text{V}/\text{V}$
Linear Input Voltage Range ⁽⁴⁾		0.2		$V_S - 1.4$	V
Input Bias Current vs Temperature			± 0.3	± 1.5	nA
			10		$\text{pA}/^{\circ}\text{C}$
Input Offset Current vs Temperature			± 0.1	± 1.5	nA
			10		$\text{pA}/^{\circ}\text{C}$
Input Impedance: Differential			30 6		$\text{G}\Omega$ pF
Input Impedance: Common-Mode			50 20		$\text{G}\Omega$ pF
Input Voltage Noise	RTI, dc to 10Hz, $G_F = 100$, $R_S = 0\Omega$		1.2		μV_{PP}
Input Voltage Noise Density	RTI, voltage noise density, $f = 1\text{kHz}$, Coarse Offset Adjust = 0V		50		$\text{nV}/\sqrt{\text{Hz}}$
	RTI, voltage noise density, $f = 1\text{kHz}$, Coarse Offset Adjust = 100mV		80		$\text{nV}/\sqrt{\text{Hz}}$
Input EMI Filter Frequency $f_{3\text{dB}}$	Input EMI filter to GND, V_{IN1} and V_{IN2}		40		MHz
PGA Gain ⁽⁵⁾					
Gain Range Steps	4, 6, 8, 12, 16, 32, 64, 100, 200, 400, 480, 600, 800, 960, 1200, 1600	4		1600	V/V
Initial Gain Error	$G_F \leq 16$		± 0.03	± 0.25	%
	$32 \leq G_F \leq 480$		± 0.1	± 0.4	%
	$600 \leq G_F \leq 1600$		± 0.3	± 1	%
vs Temperature			6		$\text{ppm}/^{\circ}\text{C}$
Output Voltage Range		0.05		$V_S - 0.05$	V
Bandwidth	$G_F = 4$		400		kHz
	$G_F = 1600$		10		kHz

- (1) PGA308 total differential gain from input ($V_{\text{IN1}} - V_{\text{IN2}}$) to output (V_{OUT}): $V_{\text{OUT}} / (V_{\text{IN1}} - V_{\text{IN2}}) = (\text{PGA gain}) \times (\text{output amplifier gain}) \times (\text{fine gain adjust})$ with output amplifier internal gains used.
- (2) Based on bridge sensor excitation voltage of +5V and PGA308 output voltage span of 4V. Individual applications must consider noise, small-signal bandwidth, and required system error to assess if the PGA308 will work for a given sensor sensitivity.
- (3) RTI = Referred-to-input.
- (4) Linear input range is the allowed min/max voltage on the V_{IN1} and V_{IN2} pins for the front-end PGA to continue to operate in a linear region. The allowed common-mode and differential voltage depends on gain and offset settings. Refer to the [PGA308 User's Guide \(SBOU069\)](#), for more information.
- (5) I_{REF} current load is typically 100 μA while in Shutdown mode. Although the output amplifier is disabled in Shutdown mode, RFO and RGO (180k Ω typical total) remain connected in series between V_{FB} and GND while in Shutdown mode. See [Figure 37, Detailed Block Diagram](#), for more information.

ELECTRICAL CHARACTERISTICS (continued)

Boldface limits apply over the specified temperature range, $T_A = -40^{\circ}\text{C}$ to $+125^{\circ}\text{C}$.

At $T_A = +25^{\circ}\text{C}$, $V_S = +5\text{V}$, $\text{GND} = 0\text{V}$, $D_{\text{OUT}}/V_{\text{CLAMP}} = +5\text{V}$, and $V_{\text{REF}} = +5\text{V}$, unless otherwise noted.

PARAMETER	CONDITIONS	PGA308			UNIT
		MIN	TYP	MAX	
Coarse Offset Adjust (RTI of Front-End PGA)⁽⁶⁾					
Range	$V_{\text{REF}} = +5\text{V}$	-100		+100	mV
Resolution	7 bit + sign, $V_{\text{REF}} = +5\text{V}$		1		mV
PSRR			2		$\mu\text{V}/\text{V}$
CMRR			1		$\mu\text{V}/\text{V}$
Drift	Coarse Offset Adjust = 100mV		1.2		$\mu\text{V}/^{\circ}\text{C}$
Fine Offset Adjust (Zero DAC)					
Programming Range	RTO of Front-End PGA	$-0.5V_{\text{REF}}$		$+0.5V_{\text{REF}}$	V
Output Voltage Range		0.1		$V_S - 0.1$	V
Resolution	65,536 steps, 16-bit DAC, $V_{\text{REF}} = +5\text{V}$		76		μV
Integral Nonlinearity			± 6		LSB
Differential Nonlinearity			± 0.5		LSB
Gain Error			± 0.5		%
Gain Error Drift			± 4		ppm/$^{\circ}\text{C}$
Offset			± 4		mV
Offset Drift			± 10		$\mu\text{V}/^{\circ}\text{C}$
PSRR			± 200		$\mu\text{V}/\text{V}$
Output Amplifier					
Output Fine Gain Adjust (Gain DAC)					
Range		0.33		1	V/V
Resolution	65,536 steps, 16-bit DAC		10		$\mu\text{V}/\text{V}$
Integral Nonlinearity			± 6		LSB
Differential Nonlinearity			± 0.5		LSB
Gain Error				± 0.2	%
Gain Drift			3		ppm/$^{\circ}\text{C}$
Output Amplifier					
Offset Voltage (RTI of Output Amplifier) ⁽⁶⁾			± 3		mV
vs Temperature			± 5		$\mu\text{V}/^{\circ}\text{C}$
vs Supply Voltage, V_S			± 100		$\mu\text{V}/\text{V}$
Common-Mode Input Range		0		$V_S - 1.5$	V
Input Bias Current			± 100		pA
Amplifier Internal Gain					
Gain Range Steps	2, 2.4, 3, 3.6, 4, 4.5, 6	2		6	V/V
Initial Gain Error			± 0.05	± 0.25	%
vs Temperature			± 1		ppm/$^{\circ}\text{C}$
Output Voltage Range	$I_{\text{OUT}} = 0.5\text{mA}^{(7)}$	0.03		$V_S - 0.06$	V
	$I_{\text{OUT}} = 4\text{mA}^{(7)}$	0.1		$V_S - 0.1$	V
Output Short-Circuit Current	I_{SC} Sourcing/sinking	10			mA
Open-Loop Gain at 0.1Hz			106		dB
Gain-Bandwidth Product			2		MHz
Phase Margin	Gain = 2, $C_L = 200\text{pF}$		45		deg
Output Resistance	R_O AC small-signal, open-loop, $f = 1\text{MHz}$, $I_{\text{OUT}} = 0$, see Figure 28		500		Ω

(6) RTI = Referred-to-input.

(7) Unless limited by the over/under-scale setting, or V_{CLAMP} pin.

ELECTRICAL CHARACTERISTICS (continued)
Boldface limits apply over the specified temperature range, $T_A = -40^{\circ}\text{C}$ to $+125^{\circ}\text{C}$.

 At $T_A = +25^{\circ}\text{C}$, $V_S = +5\text{V}$, $\text{GND} = 0\text{V}$, $D_{\text{OUT}}/V_{\text{CLAMP}} = +5\text{V}$, and $V_{\text{REF}} = +5\text{V}$, unless otherwise noted.

PARAMETER	CONDITIONS	PGA308			UNIT
		MIN	TYP	MAX	
Over- and Under-Scale Limits					
Over-Scale Thresholds	$V_{\text{LIM}} = 4\text{V}$, register-selectable ratio of V_{LIM}				
OS0	HL[2:0] (CFG1 register D[5:3]) = 000	0.97	0.9805	0.99	V/V
OS1	HL[2:0] (CFG1 register D[5:3]) = 001	0.9588	0.9688	0.9788	V/V
OS2	HL[2:0] (CFG1 register D[5:3]) = 010	0.9509	0.9609	0.9709	V/V
OS3	HL[2:0] (CFG1 register D[5:3]) = 011	0.9392	0.9492	0.9492	V/V
OS4	HL[2:0] (CFG1 register D[5:3]) = 100	0.8416	0.8516	0.8616	V/V
OS5	HL[2:0] (CFG1 register D[5:3]) = 101	0.7673	0.7773	0.7873	V/V
OS6	HL[2:0] (CFG1 register D[5:3]) = 110	0.6189	0.6289	0.6389	V/V
OS7	HL[2:0] (CFG1 register D[5:3]) = 111	0.5603	0.5703	0.5803	V/V
Over-Scale Threshold Tempco			± 3		ppm/$^{\circ}\text{C}$
Over-Scale Amplifier Offset			± 9		mV
Over-Scale Amplifier Offset Drift			± 10		$\mu\text{V}/^{\circ}\text{C}$
Under-Scale Thresholds	$V_{\text{LIM}} = 5\text{V}$, register-selectable ratio of V_{LIM}				
US7	LL[2:0] (CFG1 register D[2:0]) = 111	0.0487	0.0547	0.0607	V/V
US6	LL[2:0] (CFG1 register D[2:0]) = 110	0.04478	0.05078	0.05678	V/V
US5	LL[2:0] (CFG1 register D[2:0]) = 101	0.04088	0.04688	0.05288	V/V
US4	LL[2:0] (CFG1 register D[2:0]) = 100	0.03306	0.03906	0.04506	V/V
US3	LL[2:0] (CFG1 register D[2:0]) = 011	0.02916	0.03516	0.04116	V/V
US2	LL[2:0] (CFG1 register D[2:0]) = 010	0.02525	0.03125	0.03725	V/V
US1	LL[2:0] (CFG1 register D[2:0]) = 001	0.01743	0.02343	0.02943	V/V
US0	LL[2:0] (CFG1 register D[2:0]) = 000	0.01353	0.01953	0.02553	V/V
Under-Scale Threshold Tempco			± 3		ppm/$^{\circ}\text{C}$
Under-Scale Amplifier Offset			± 9		mV
Under-Scale Amplifier Offset Drift			± 10		$\mu\text{V}/^{\circ}\text{C}$
Output Voltage Clamp					
Input Voltage Range	$V_{\text{CLAMP}} \leq V_S$, $V_S = +5\text{V}$	1.25		4.95	V
Input Bias Current			± 60		nA
V_{OUT} Clamp Point		$V_{\text{CLAMP}} - 0.05$	V_{CLAMP}	$V_{\text{CLAMP}} + 0.05$	V
Fault Monitor Circuit (External Comparators)					
INP_HI Comparator Threshold INN_HI Comparator Threshold	Fault Detect Mode Select = 0 (bridge fault); see CFG1 register	Smaller of $(V_S - 1.2)$ or $(0.65V_{\text{FLT}})$			V
INP_LO Comparator Threshold INN_LO Comparator Threshold	Fault Detect Mode Select = 0 (bridge fault); see CFG1 register	Larger of (0.1V) or $(0.35V_{\text{FLT}})$			V
Fault Monitor Reference	V_{FLT} Fault Monitor Reference; see CFG1 register, FLT REF bit sets V_{FLT}		V_S or V_{REF}		V
INP_HI Comparator Threshold INN_HI Comparator Threshold	Fault Detect Mode Select = 1 (common-mode fault); see CFG1 register		$V_S - 1.2$		V
INP_LO Comparator Threshold INN_LO Comparator Threshold	Fault Detect Mode Select = 1 (common-mode fault); see CFG1 register	70	100	130	mV
Comparator Hysteresis			7		mV
Comparator Input Offset Voltage			± 10		mV
Fault Monitor Circuit (Internal Comparators)					
A1SAT_LO Comparator Threshold A2SAT_LO Comparator Threshold	Threshold is amplifier negative saturation voltage		100		mV
A1SAT_HI Comparator Threshold A2SAT_HI Comparator Threshold	Threshold is amplifier positive saturation voltage		$V_S - 0.12$		V
A3SAT_LO Comparator Threshold	Threshold is amplifier negative saturation voltage		50		mV
V_{IN1}, V_{IN2} Pull-up Current Sources					
Pull-Up Current Source	I_{PU} Register-selectable	15	30	45	nA
Current Source Matching			± 1.5	± 7	nA
Current Source Tempco			± 5		pA/$^{\circ}\text{C}$

ELECTRICAL CHARACTERISTICS (continued)

Boldface limits apply over the specified temperature range, $T_A = -40^{\circ}\text{C}$ to $+125^{\circ}\text{C}$.

At $T_A = +25^{\circ}\text{C}$, $V_S = +5\text{V}$, $\text{GND} = 0\text{V}$, $D_{\text{OUT}}/V_{\text{CLAMP}} = +5\text{V}$, and $V_{\text{REF}} = +5\text{V}$, unless otherwise noted.

PARAMETER	CONDITIONS	PGA308			UNIT
		MIN	TYP	MAX	
V_{REF} Input Range		1.8		V_S	V
Input Resistance			43		k Ω
Digital Interface One-Wire	Serial speed baud rate	4.8k		114k	bits/s
Logic Levels Logic Levels (1W pin)	Low			0.8	V
	High	2.0			V
	Hysteresis		100		mV
Output Low Level (1W pin)	Open drain, $I_{\text{SINK}} = 4\text{mA}$			0.4	V
Output Levels ($D_{\text{OUT}}/V_{\text{CLAMP}}$)	Low, D_{OUT} mode selected, $I_{\text{SINK}} = 4\text{mA}$ and $V_S = +4.5\text{V}$, or $I_{\text{SINK}} = 2\text{mA}$ and $V_S = +2.7\text{V}$			0.4	V
	High, D_{OUT} mode selected, $I_{\text{SOURCE}} = 4\text{mA}$ and $V_S = +4.5\text{V}$, or $I_{\text{SOURCE}} = 2\text{mA}$ and $V_S = +2.7\text{V}$	$V_S - 0.4$			V
POWER SUPPLY Supply Voltage	V_S	2.7		5.5	V
OTP Program Voltage	$V_{\text{S-PGM}}$	4.5		5.5	V
Quiescent Current	I_Q $V_S = +5\text{V}$, does not include I_{REF}		1.3	1.6	mA
Shutdown Supply Current	I_{SHDN} $V_S = +5\text{V}$, does not include I_{REF} ⁽⁸⁾		260		μA
POWER-ON RESET (POR) Power-Up Threshold	V_S rising		2.1		V
Power-Down Threshold	V_S falling		1.7		V
TEMPERATURE RANGE Specified Performance Range		-40		+125	$^{\circ}\text{C}$
Operational-Degraded Performance Range		-40		+150	$^{\circ}\text{C}$
Thermal Resistance MSOP-10, Junction-to-Ambient	θ_{JA}		150		$^{\circ}\text{C}/\text{W}$

- (8) I_{REF} current load is typically $100\mu\text{A}$ while in Shutdown mode. Although the output amplifier is disabled in Shutdown mode, RFO and RGO ($180\text{k}\Omega$ typical total) remain connected in series between V_{FB} and GND while in Shutdown mode. See [Figure 37, Detailed Block Diagram](#), for more information.

TYPICAL THREE-WIRE APPLICATION CIRCUIT

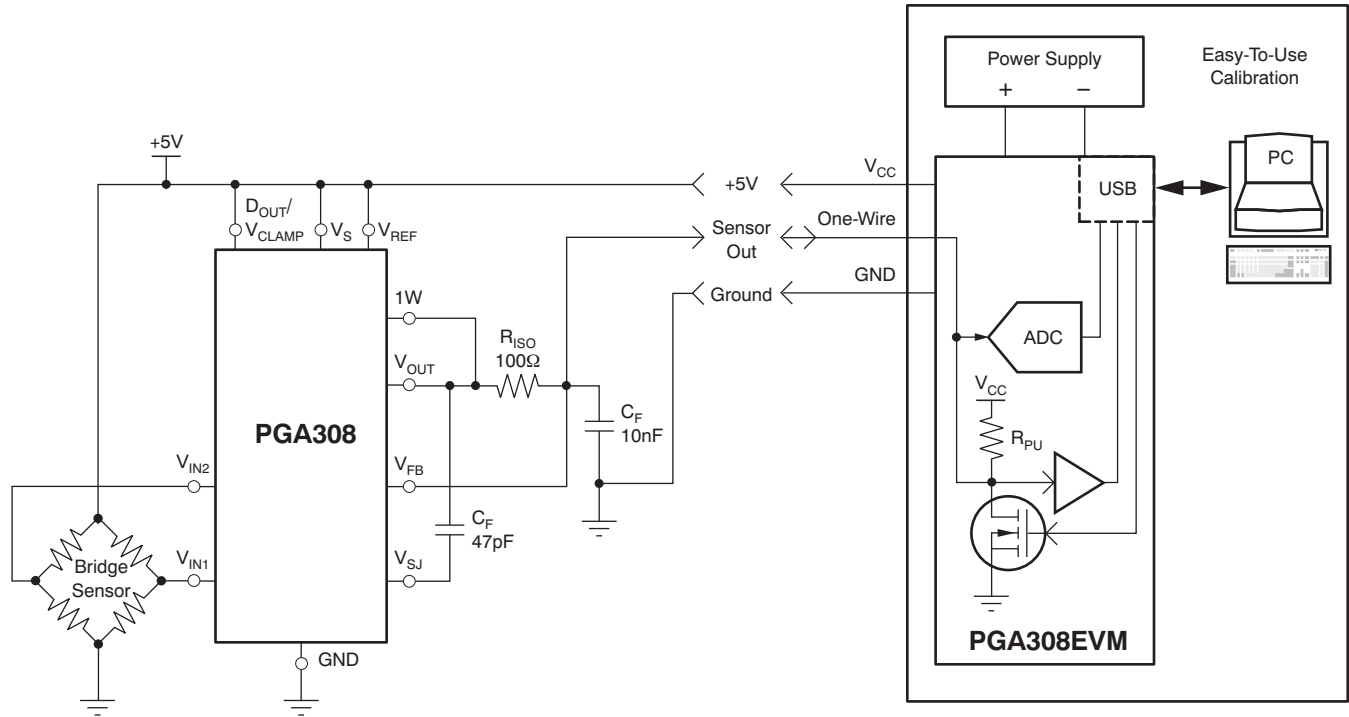

PIN CONFIGURATIONS

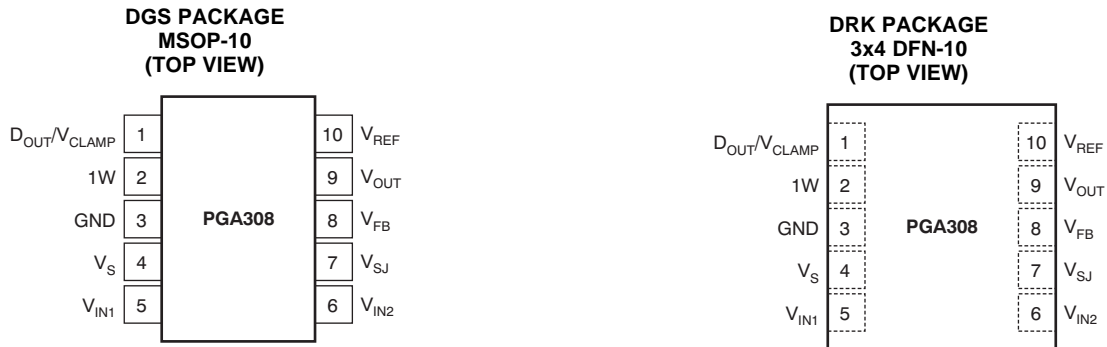

PIN DESCRIPTIONS

PIN #	NAME	DESCRIPTION
1	D_{OUT}/V_{CLAMP}	Dual-use pin: Output voltage clamp limit for V_{OUT} or programmable digital output. The output voltage clamp function is for use in multiple supply systems where the PGA308 may be at $V_S = +5V$ and the system analog-to-digital converter (ADC) is powered at +3V. Setting V_{CLAMP} to +3.2V prevents over-voltage and latch-up on the system ADC input. V_{CLAMP} may be set through a resistor divider from V_S . If configured for digital output, the D_{OUT} function allows for configuration plus calibration of a sensor module either through the One-Wire interface (1W pin) or as a permanently configured module through the power-on reset (POR) OTP memory setting.
2	1W	One-Wire interface program pin. UART interface for digital calibration of the PGA308 over a single wire. Can be connected to V_{OUT} for a three terminal (V_S , GND, V_{OUT}) programmable sensor assembly.
3	GND	Ground.
4	V_S	+Voltage supply.
5	V_{IN1}	Signal input voltage 1. Connect to + or – output of the sensor bridge. Internal multiplexer can change connection internally to front-end PGA.
6	V_{IN2}	Signal input voltage 2. Connect to + or – output of the sensor bridge. Internal multiplexer can change connection internally to front-end PGA.
7	V_{SJ}	Output amplifier summing junction. Use for output amplifier compensation when driving large capacitive loads (> 200pF) and/or for using external gain setting resistors for the output amplifier.
8	V_{FB}	V_{OUT} feedback pin. Voltage feedback sense point for over-/under-scale limit circuitry. If internal gain set resistors for the output amplifier are used, this pin is also the voltage feedback sense point for the output amplifier. V_{FB} in combination with V_{SJ} allows for use of external filter and protection circuits without degrading the PGA308 V_{OUT} accuracy. V_{FB} must always be connected to either V_{OUT} or the point of feedback for V_{OUT} if external filtering is used.
9	V_{OUT}	Analog output voltage of conditioned sensor.
10	V_{REF}	Reference voltage input pin. V_{REF} is used for coarse offset adjust and Zero DAC. V_{REF} or V_S may be individually selected for over-/under-scale threshold reference and fault monitor comparator reference.

TYPICAL CHARACTERISTICS

At $T_A = +25^\circ\text{C}$, $V_S = V_{REF} = D_{OUT}/V_{CLAMP} = +5\text{V}$, $R_L = 10\text{k}\Omega$ and $C_L = 100\text{pF}$ connected to GND, unless otherwise noted.
Gain format is presented: $G = \text{FE-PGA} \times \text{Fine Gain} \times \text{Output Gain}$.

FRONT-END PGA INPUT BIAS CURRENT WITH I_{PU} ENABLED vs TEMPERATURE

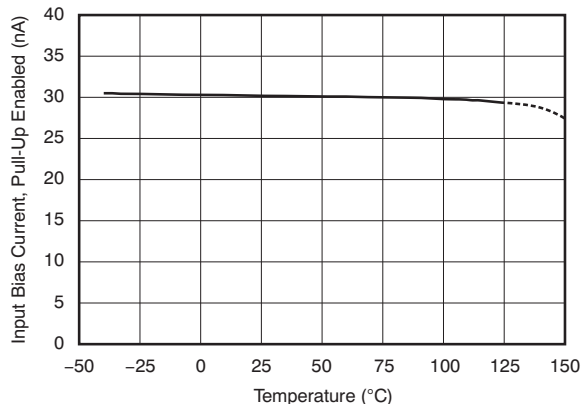

Figure 1.

FRONT-END PGA INPUT BIAS CURRENT WITH I_{PU} DISABLED vs TEMPERATURE

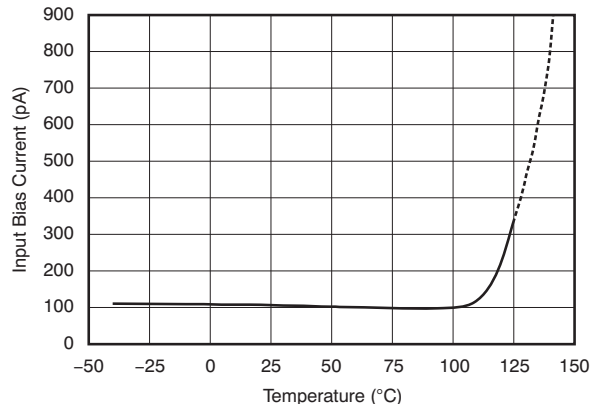

Figure 2.

COARSE OFFSET ADJUST ERROR vs TEMPERATURE

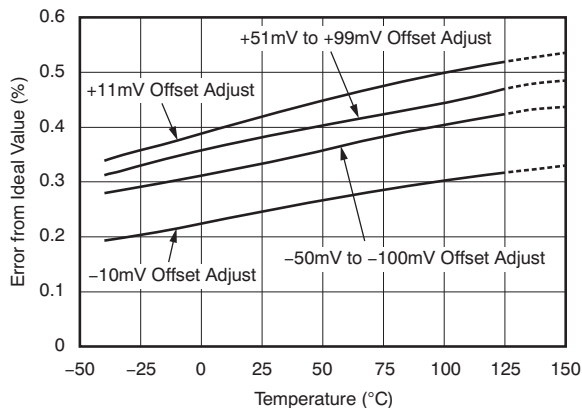

Figure 3.

FRONT-END PGA OFFSET VOLTAGE vs TEMPERATURE

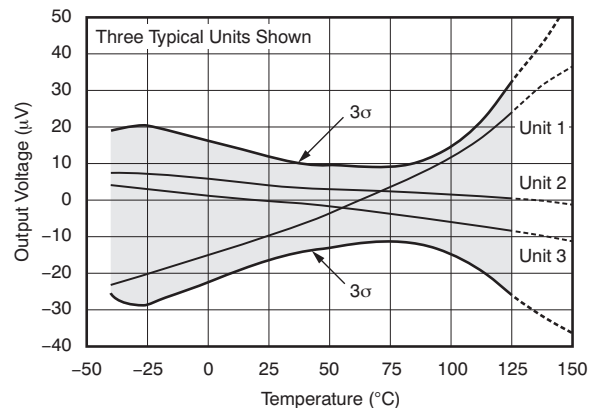

Figure 4.

0.1Hz TO 10Hz OUTPUT NOISE (G = 1600)

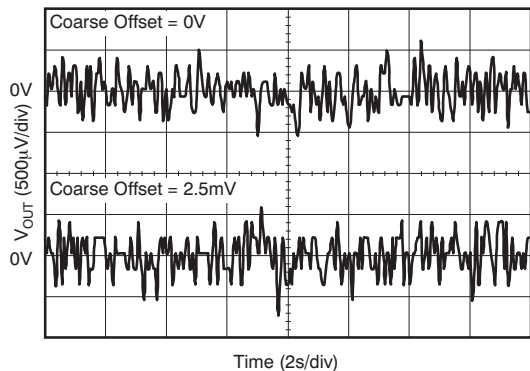

Figure 5.

INPUT-REFERRED FRONT-END NOISE vs FREQUENCY

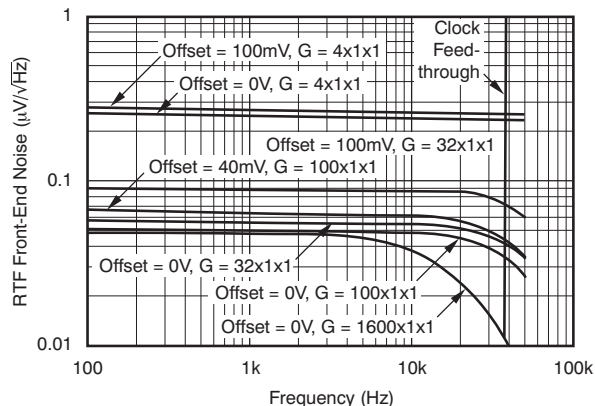

Figure 6.

TYPICAL CHARACTERISTICS (continued)

At $T_A = +25^\circ\text{C}$, $V_S = V_{REF} = D_{OUT}/V_{CLAMP} = +5\text{V}$, $R_L = 10\text{k}\Omega$ and $C_L = 100\text{pF}$ connected to GND, unless otherwise noted.

Gain format is presented: $G = \text{FE-PGA} \times \text{Fine Gain} \times \text{Output Gain}$.

OVER-SCALE TOTAL ERROR vs TEMPERATURE (5V Ref)

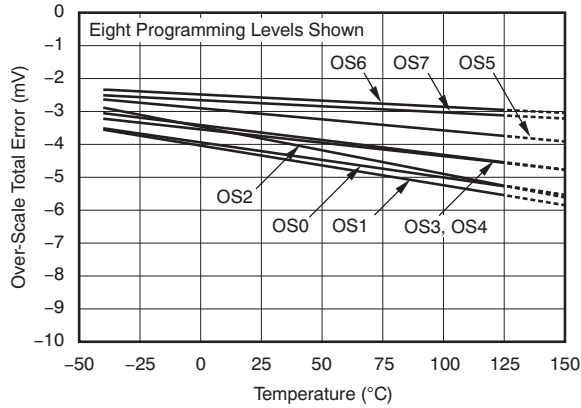

Figure 7.

UNDER-SCALE TOTAL ERROR vs TEMPERATURE (4V Ref)

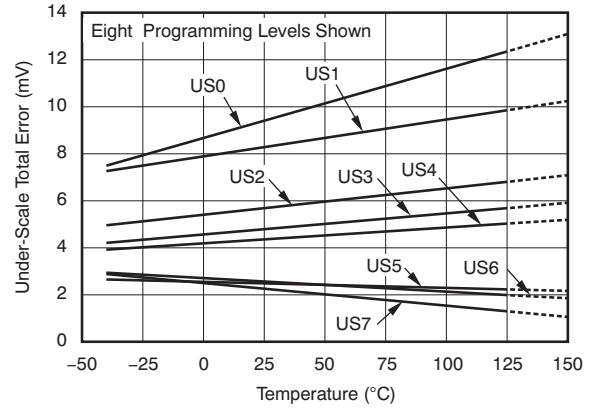

Figure 8.

ZERO DAC OFFSET ERROR vs TEMPERATURE

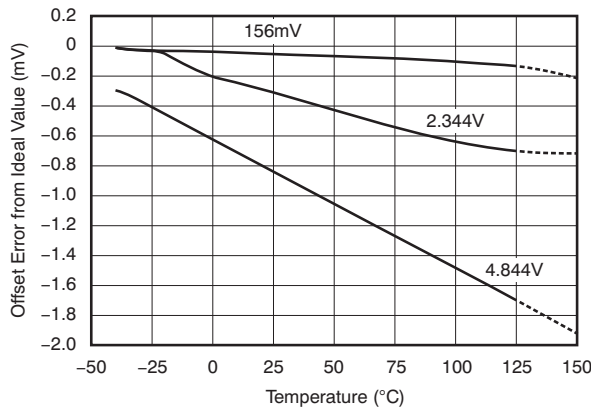

Figure 9.

COMMON-MODE REJECTION (RTI) vs FREQUENCY

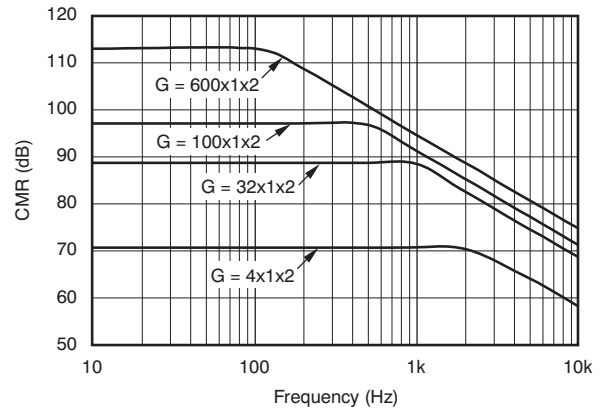

Figure 10.

POWER-SUPPLY REJECTION RATIO (RTI) vs FREQUENCY

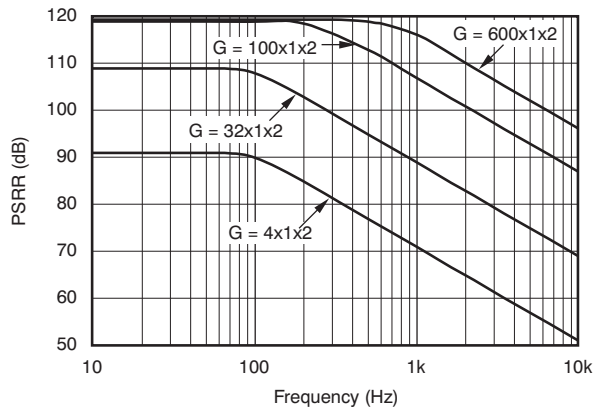

Figure 11.

GAIN vs FREQUENCY

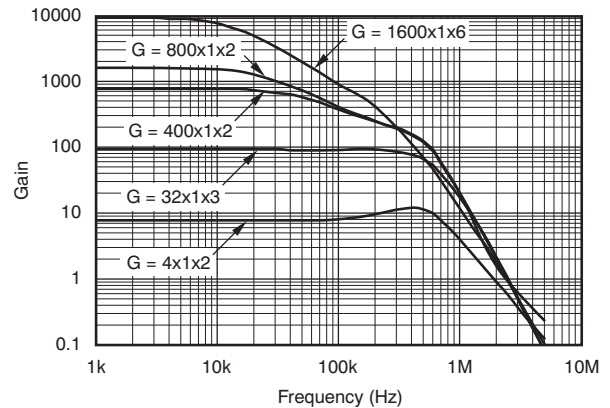

Figure 12.

TYPICAL CHARACTERISTICS (continued)

At $T_A = +25^\circ\text{C}$, $V_S = V_{REF} = D_{OUT}/V_{CLAMP} = +5\text{V}$, $R_L = 10\text{k}\Omega$ and $C_L = 100\text{pF}$ connected to GND, unless otherwise noted.

Gain format is presented: $G = \text{FE-PGA} \times \text{Fine Gain} \times \text{Output Gain}$.

V_{OUT} WITH V_{CLAMP} HIGH (4.94V) vs TEMPERATURE

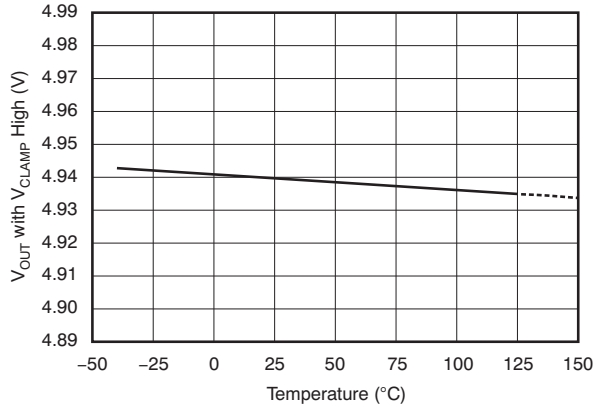

Figure 13.

V_{OUT} WITH V_{CLAMP} LOW (1.25V) vs TEMPERATURE

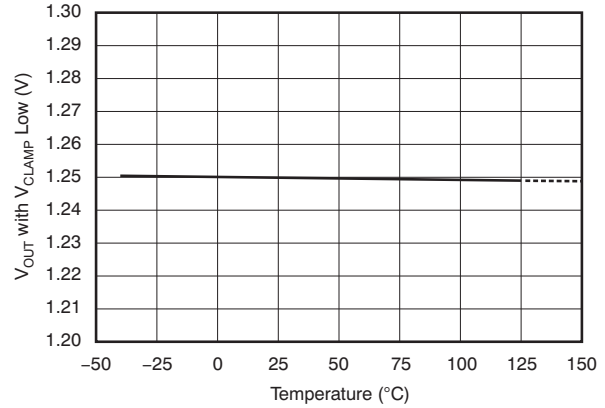

Figure 14.

COMMON-MODE OVER-VOLTAGE RECOVERY

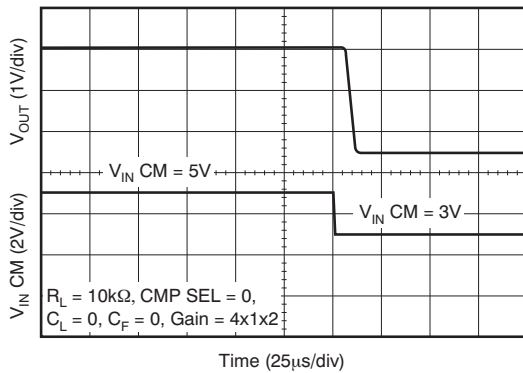

Figure 15.

V_{CLAMP} RESPONSE (No Cap Load, CMP SEL = 1)

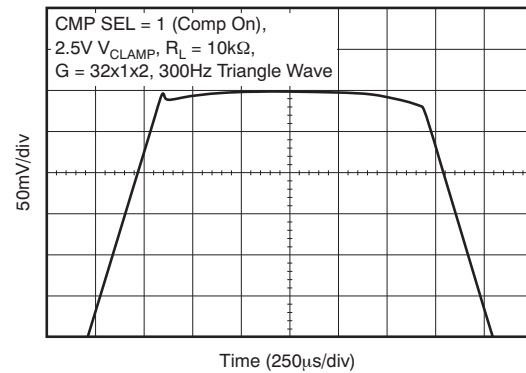

Figure 16.

V_{CLAMP} RESPONSE (No Cap Load, CMP SEL = 0)

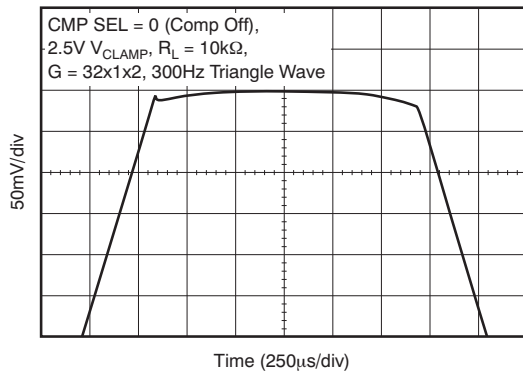

Figure 17.

V_{CLAMP} RESPONSE ($C_L = 10\text{nF}$, CMP SEL = 1)

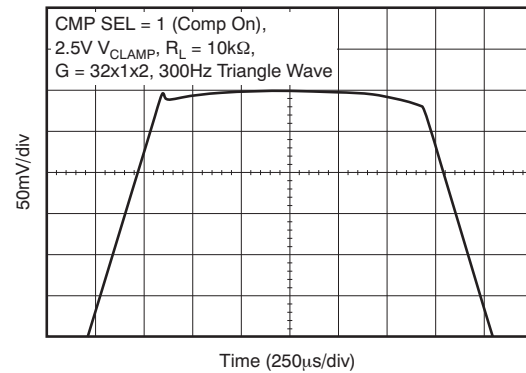

Figure 18.

TYPICAL CHARACTERISTICS (continued)

At $T_A = +25^\circ\text{C}$, $V_S = V_{REF} = D_{OUT}/V_{CLAMP} = +5\text{V}$, $R_L = 10\text{k}\Omega$ and $C_L = 100\text{pF}$ connected to GND, unless otherwise noted.

Gain format is presented: $G = \text{FE-PGA} \times \text{Fine Gain} \times \text{Output Gain}$.

**V_{CLAMP} RESPONSE
($C_L = 10\text{nF}$, $\text{CMP SEL} = 0$)**

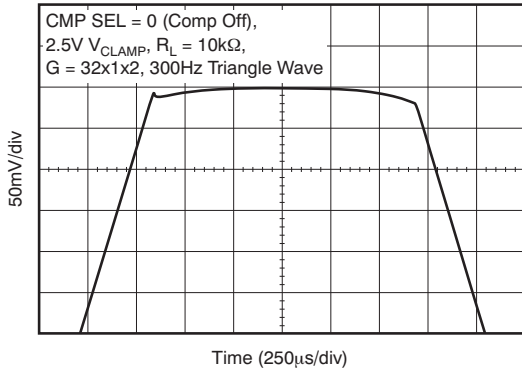

Figure 19.

**OUTPUT VOLTAGE vs
OUTPUT CURRENT**

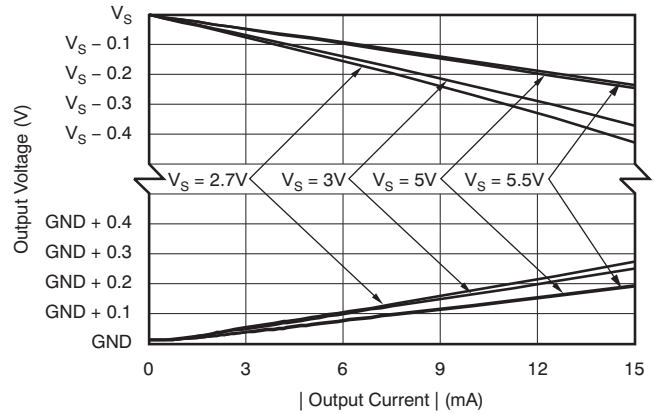

Figure 20.

**QUIESCENT CURRENT vs
TEMPERATURE**

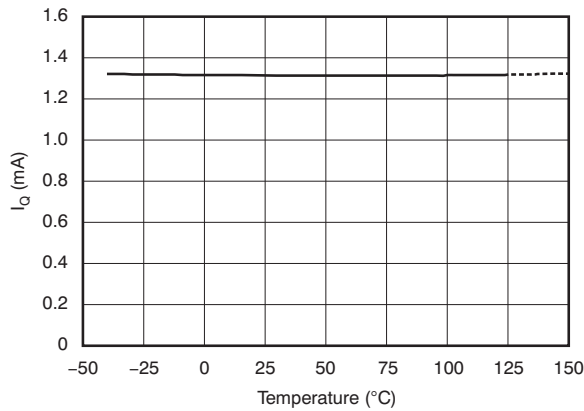

Figure 21.

**OUTPUT AMPLIFIER OPEN-LOOP GAIN vs
FREQUENCY (CMP SEL = 1)**

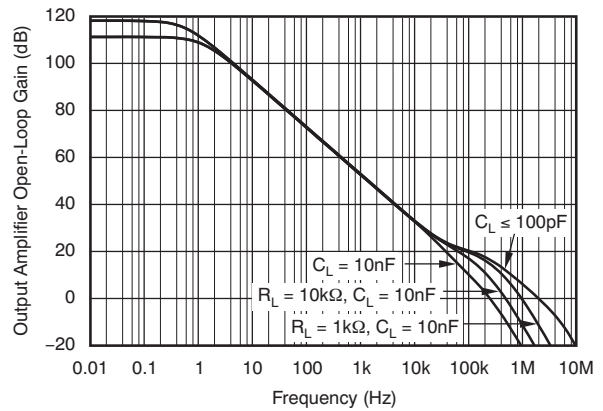

Figure 22.

**OUTPUT AMPLIFIER OPEN-LOOP GAIN vs
FREQUENCY (CMP SEL = 0)**

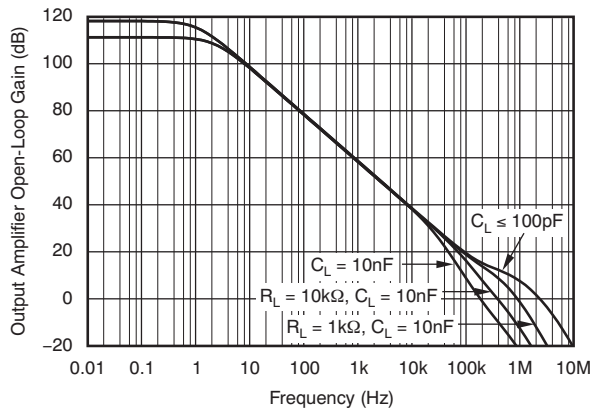

Figure 23.

**OUTPUT AMPLIFIER OPEN-LOOP PHASE vs
FREQUENCY (CMP SEL = 1)**

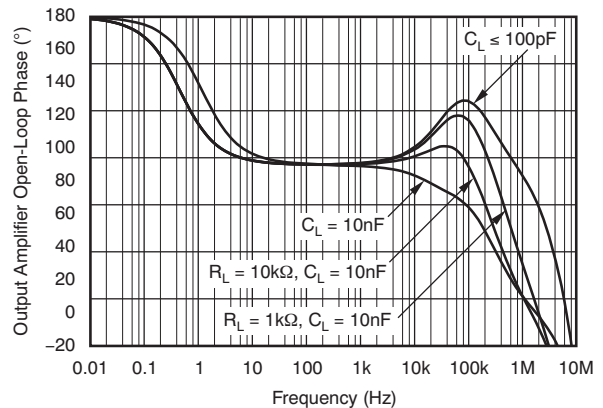

Figure 24.

TYPICAL CHARACTERISTICS (continued)

At $T_A = +25^\circ\text{C}$, $V_S = V_{REF} = D_{OUT}/V_{CLAMP} = +5\text{V}$, $R_L = 10\text{k}\Omega$ and $C_L = 100\text{pF}$ connected to GND, unless otherwise noted.

Gain format is presented: $G = \text{FE-PGA} \times \text{Fine Gain} \times \text{Output Gain}$.

OUTPUT AMPLIFIER OPEN-LOOP PHASE vs FREQUENCY (CMP SEL = 0)

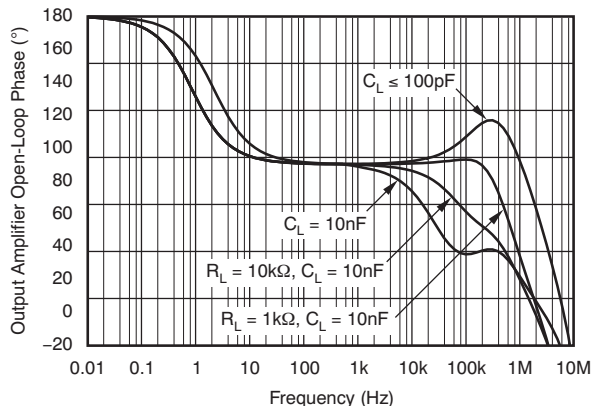

Figure 25.

CAPACITIVE LOAD DRIVE CL = 1nF

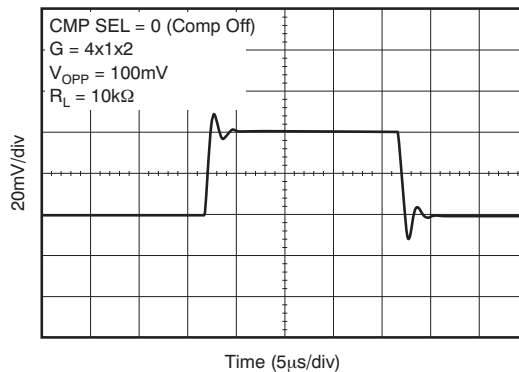

Figure 26.

CAPACITIVE LOAD DRIVE CL = 10pF

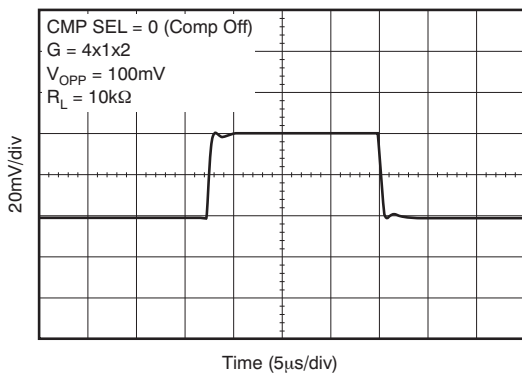

Figure 27.

OPEN-LOOP OUTPUT IMPEDANCE vs FREQUENCY

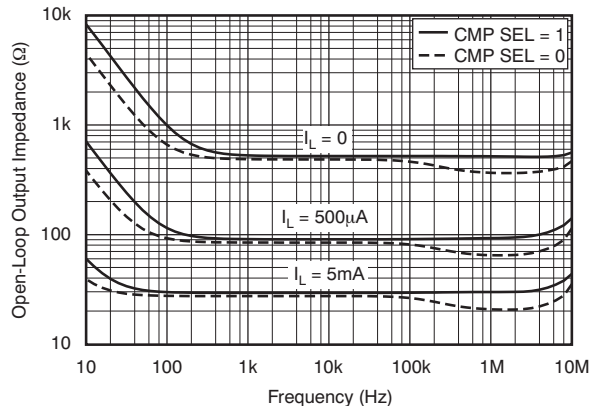

Figure 28.

SMALL-SIGNAL STEP RESPONSE CMP SEL = 1

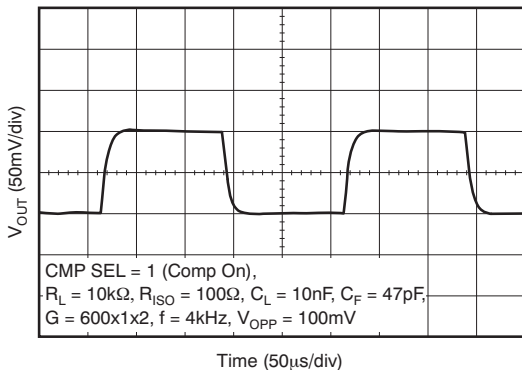

Figure 29.

LARGE-SIGNAL STEP RESPONSE CMP SEL = 1

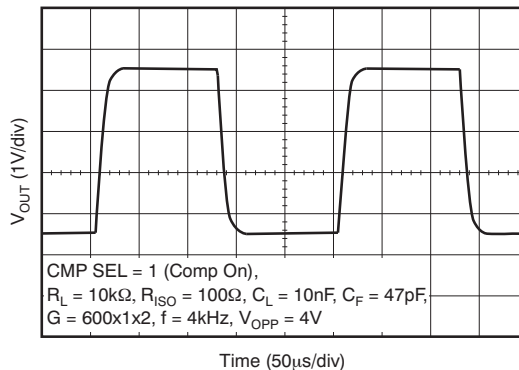

Figure 30.

TYPICAL CHARACTERISTICS (continued)

At $T_A = +25^\circ\text{C}$, $V_S = V_{REF} = D_{OUT}/V_{CLAMP} = +5\text{V}$, $R_L = 10\text{k}\Omega$ and $C_L = 100\text{pF}$ connected to GND, unless otherwise noted.

Gain format is presented: $G = \text{FE-PGA} \times \text{Fine Gain} \times \text{Output Gain}$.

**SMALL-SIGNAL STEP RESPONSE
CMP SEL = 1**

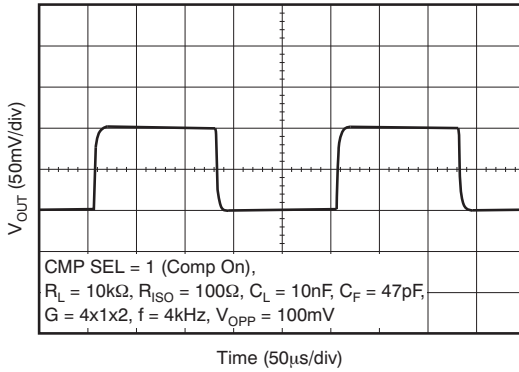

Figure 31.

**LARGE-SIGNAL STEP RESPONSE
CMP SEL = 1**

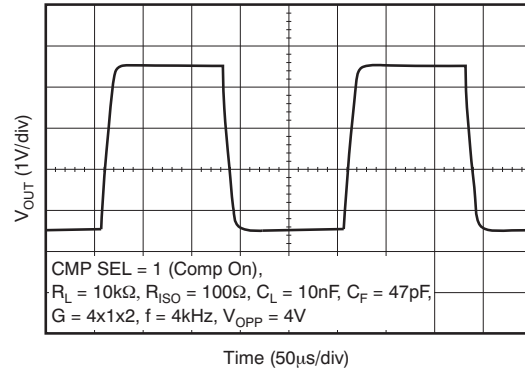

Figure 32.

**SMALL-SIGNAL STEP RESPONSE
CMP SEL = 0**

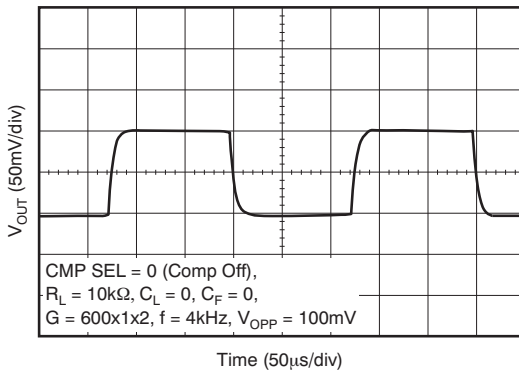

Figure 33.

**LARGE-SIGNAL STEP RESPONSE
CMP SEL = 0**

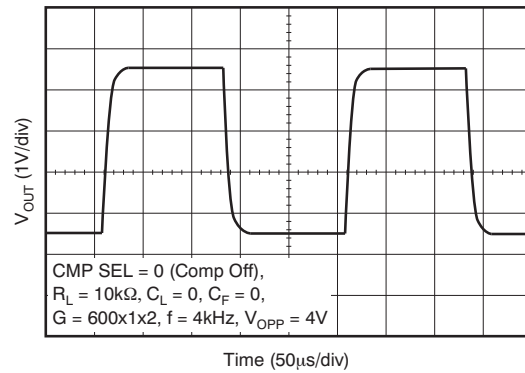

Figure 34.

**SMALL-SIGNAL STEP RESPONSE
CMP SEL = 0**

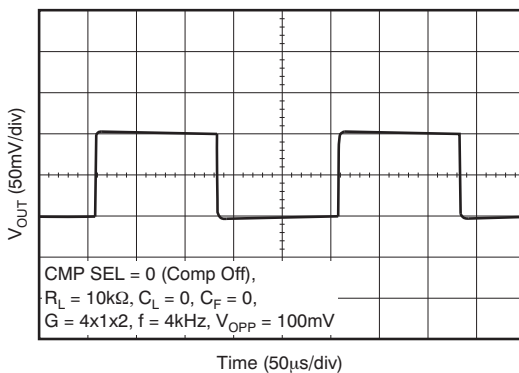

Figure 35.

**LARGE-SIGNAL STEP RESPONSE
CMP SEL = 0**

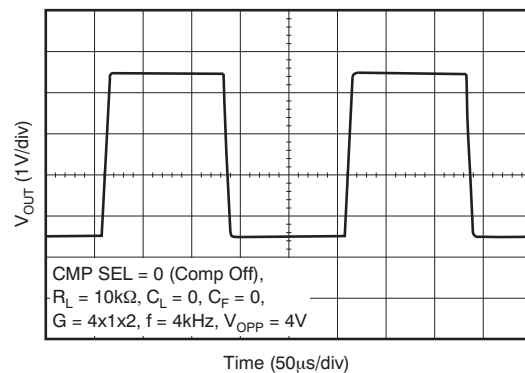

Figure 36.

FUNCTIONAL DESCRIPTION

OVERVIEW

The PGA308 is an ideal building block for resistive bridge sensor conditioning and general data acquisition. Digitally-programmable coarse offset, fine offset, and gain may be controlled in real time or permanently programmed into the PGA308.

SENSOR ERROR ADJUSTMENT RANGE

The PGA308 is designed to readily accommodate the following sensors:

Span_{25°C}: 0.08mV/V to 296mV/V

Initial Offset: 20mV/V

Span and offset are based on a bridge sensor excitation voltage of +5V, a PGA308 output voltage span of 4V (+0.5V to +4.5V), V_{REF} of +5V, and a V_{OUT}/V_{IN} gain up to 9600. For proper PGA308 setup, consider noise, small-signal bandwidth, V_{OUT}/V_{IN} gain, and required system error.

AMPLIFICATION SIGNAL PATH

The core of the PGA308 is a precision, low drift, and low noise front-end programmable gain amplifier (PGA). This front-end PGA has gain capabilities from $\times 4$ to $\times 1600$. The output amplifier has a gain range from $\times 2$ to $\times 6$. A fine gain adjust in front of the output amplifier offers a selectable $\times 0.33$ to $\times 1.0$ *attenuation factor*. This architecture yields a V_{OUT}/V_{IN} gain range for the PGA308 of $\times 2.67$ to $\times 9600$. Many applications use overall gains of $\times 1600$ or less. The selection of gains in the front-end PGA and output amplifier, although capable of up to $\times 9600$ overall gain, are intended to allow for gain distribution throughout the PGA308; this design enables optimum span and offset scaling from input to output. The polarity of the inputs can be switched through the input mux to accommodate sensors with unknown polarity output. Higher gains reduce bandwidth and require more analog filtering and/or system analog-to-digital converter (ADC) averaging to reject noise.

COARSE AND FINE OFFSET ADJUSTMENT

The sensor offset adjustment is done in two stages. The input-referred Coarse Offset Adjust DAC has a ± 100 mV offset adjustment range for a selected V_{REF} of +5V. Any residual input sensor offset is corrected and any desired V_{OUT} offset pedestal for zero-applied sensor strain input is set by a Fine Offset Adjust through the 16-bit Zero DAC that adds to the signal from the output of the front-end PGA.

VOLTAGE REFERENCE

The PGA308 V_{REF} pin provides input from a reference voltage. The reference voltage is used by the Coarse Offset Adjust and Zero DACs. The fault monitor circuitry trip points, as well as the over- and under-scale limits, can be selected to be referenced to either V_S or V_{REF} . This flexibility accommodates absolute or ratiometric mode designs.

FAULT MONITOR CIRCUIT SENSOR FAULT DETECTION

To detect sensor burnout and/or short, a set of four comparators (external fault comparators) are connected to the inputs of the front-end PGA. There are two fault-detect modes of operation for these comparators.

Common-Mode Fault

If either of the inputs are taken outside of the common-mode range of the amplifier [greater than $(V_S - 1.2V)$, or less than 100mV], then the corresponding comparator sets a sensor fault flag that can be programmed to drive the PGA308 V_{OUT} to within 100mV ($I_{OUT} < 4mA$) of either V_S (or V_{CLAMP} if V_{CLAMP} is used) or ground. This level is well above the set over-scale limit level or well below the set under-scale limit level. The state of the fault condition can be read in digital form in the ALRM register. If the over-scale/under-scale limiting is disabled, the PGA308 output voltage is also driven within 100mV ($I_{OUT} < 4mA$) of either V_S (or V_{CLAMP} if V_{CLAMP} is used) or ground, depending on the selected fault polarity (high or low).

Bridge Fault

To assist in identifying mis-wiring, or open- or short-circuit conditions, the PGA308 provides bridge fault monitoring. For bridge fault detection, either V_S or V_{REF} (whichever is used for bridge excitation) can be chosen as V_{FLT} . If either of the inputs are taken to less than the larger of either 100mV or $0.35V_{FLT}$, then a fault is signaled. Also, if either of the inputs is taken to greater than the smaller of $(V_S - 1.2V)$ or $0.65V_{FLT}$, then a fault is signaled. This fault detection allows for operation with bridge differential voltages of up to 30% of the bridge excitation voltage. The corresponding comparator sets a sensor fault flag that can be programmed to drive the PGA308 V_{OUT} to within 100mV ($I_{OUT} < 4mA$) of either V_S (or V_{CLAMP} if V_{CLAMP} is used) or ground. This level is well above the set over-scale limit level or well below the set

under-scale limit level. If over-scale/under-scale limiting is disabled, the PGA308 output voltage is driven within 100mV ($I_{OUT} < 4mA$) of either V_S or ground, depending on the selected fault polarity (high or low).

Additional Fault Detection

There are five additional fault detect comparators (internal fault comparators) that help detect subtle PGA308 front-end violations that could result in linear voltages at V_{OUT} and be interpreted as valid states. These comparators are especially useful during factory calibration and setup.

Alarm Register

Each of nine fault conditions sets a corresponding bit in the Alarm register. The state of the fault condition can be read digitally from the Alarm register.

OVER-SCALE AND UNDER-SCALE LIMITS

The over-scale and under-scale limit circuitry provides a programmable upper and lower clip limit for the PGA308 output voltage. When combined with the fault monitor circuitry, system diagnostics can be performed to determine if a conditioned sensor is defective, or if the process being monitored by the sensor is out of range. The selected PGA308 V_{LIM} is divided down by a precision resistor string to form the over- and under-scale trip points. These resistor ratios are extremely accurate and produce no significant initial or temperature errors. An over-scale amplifier driven by the over-scale threshold limits (clips) the maximum PGA308 output, V_{OUT} . Similarly, an under-scale amplifier driven by the under-scale threshold limits (clips) the minimum PGA308 output, V_{OUT} . The reference for the trip points, V_{LIM} , is register-selectable for either V_{REF} or V_S .

D_{OUT}/V_{CLAMP} PIN

The dual-use D_{OUT}/V_{CLAMP} pin functions either as a V_{OUT} clamp or as a digital push-pull output. The voltage clamp function provides an output voltage clamp, which is external-resistor programmable. In mixed-voltage systems, where the PGA308 may run from +5V with its output scaled for 0.1V to 2.9V, V_{CLAMP} can be set to 3.0V to prevent an over-voltage lock-up/latch-up condition on a 3V system ADC or microcontroller input. When programmed as a digital output this pin can be used for sensor module configuration. The value may be pre-programmed in the one-time programmable (OTP) banks, or controlled through the One-Wire interface (1W pin).

DIGITAL INTERFACE: ONE-WIRE PROGRAM PROTOCOL

The PGA308 can be configured through a single-wire, UART-compatible interface (1W pin). It is possible to connect this single-wire communication pin to the V_{OUT} pin in true three-terminal modules (V_S , ground, and sensor out) and continue to allow for calibration and configuration programming.

All communication transactions start with an initialization byte transmitted by the controller. This byte (55h) sets the baud rate used for the communication transaction. The baud rate is sensed during the initialization byte of every transaction, and is used throughout the entire transaction. Each transaction may use a different baud rate, if desired. Baud rates of 4.8k to 114k bits/second are supported.

Each communication consists of several bytes of data. Each byte consists of 10-bit periods. The first bit is the start bit and is always '0'. When idle, the 1W pin should always be high. The second through ninth bits are the eight data bits for the byte and are transferred LSB first. The 10th bit is the stop bit and is always '1'.

The second byte is a command/address byte. The last bit in this byte indicates either a read or write at the address selected by the address pointer portion of the byte. Additional data transfer occurs after the command/address byte. The number of bytes and direction of data transfer depend on the command byte. For a read sequence, the PGA308 waits for a 2-bit delay (unless programmed otherwise) after the completion of the command/address byte before beginning to transmit. This wait allows time for the controller to ensure that the PGA308 is able to control the One-Wire interface. The first byte transmitted by the PGA308 is the least significant byte of the register and the second byte will be the most significant byte of the register.

The recommended circuit implementation is to use a pull-up resistor and/or current source with an open drain (or open collector) output connected to the 1W pin, which is also an open drain output. The single wire can be driven high by the controller during transmit from the controller, but some form of pull-up is required to allow the signal to go high during receive because the PGA308 1W pin can only pull the output low.

Timeout on the One-Wire Interface

The PGA308 includes a timeout mechanism. If synchronization between the controller and the PGA308 is lost for any reason, the timeout mechanism allows the One-Wire interface to reset communication. The timeout period is set to approximately 28ms (typical). If the timeout period expires between the initialization byte and the command byte, between the command byte and any data byte, or between any data bytes, the PGA308 resets the One-Wire interface circuitry so that it expects an initialization byte. Every time that a byte is transmitted on the single wire interface, this timeout period restarts.

POWER-ON SEQUENCE

The PGA308 provides circuitry to detect when the power supply is applied to the PGA308 and resets the internal registers to a known power-on reset (POR) state. This reset also occurs whenever the supply is invalid so that the PGA308 is set to a known state when the supply becomes valid again. The threshold for this circuit is approximately 1.7V to 2.1V. After the power supply becomes valid, the PGA308 waits for approximately 25ms, during which V_{OUT} is disabled, and then attempts to read the data from the last valid OTP memory bank. If the memory bank has the proper checksum, then the PGA308 RAM is loaded with the OTP data and V_{OUT} enabled. If the checksum is invalid, V_{OUT} is set to disabled. Unless disabled by the OWD bit in Configuration Register 2 (CFG2), the One-Wire interface can always communicate to the PGA308 and override the contents of the current RAM in use by setting the appropriate SWL[2:0] bits in the Software Control Register (SFTC). For applications that require *instant-on* for V_{OUT} , the NOW bit in the CFG2 register can be set to '1', which eliminates the 25ms disable of V_{OUT} on power-up.

ONE-WIRE OPERATION WITH 1W CONNECTED TO V_{OUT}

In some sensor applications, it is desired to provide the end user of the sensor module with three pins: V_S , GND, and Sensor Out. It is also desired in these applications to digitally calibrate the sensor module after its final assembly of sensor and electronics. The PGA308 has a mode that allows the One-Wire interface pin (1W) to be tied directly to the PGA308 output pin (V_{OUT}).

To calibrate the PGA308 in Three-Wire configuration, program the internal registers and measure the resulting V_{OUT} . To do this while V_{OUT} is connected to 1W requires the ability to enable and disable V_{OUT} . Thus, the 1W/ V_{OUT} line operates in a multiplexed mode where 1W is used as a bidirectional digital interface while V_{OUT} is disabled, and V_{OUT} drives the line as a conditioned sensor output voltage when it is enabled.

The PGA308 also provides a mode in which the output amplifier can be enabled for a set time period and then disabled again to allow sharing of the 1W pin with the V_{OUT} connection. This action is accomplished by writing a value to bits OEN[7:0] in the One-Wire Enable Control register (OENC). Any non-zero value enables the output. This non-zero value is decremented every 10ms until it becomes zero. When this value becomes zero, V_{OUT} is disabled and a 1s timeout begins waiting for bus activity on the digital interface (1W pin). As long as there is activity on the 1W pin, the 1s timeout is continually reset. After 1s of no bus activity, the PGA308 checks for a correct checksum. If the checksum is correct, the PGA308 runs with the values that currently exist in RAM. If the checksum is not valid, the PGA308 checks for written bank select registers in OTP in the order of BANK SEL4, BANK SEL3, BANK SEL2 then BANK SEL1. The highest bank select register containing valid programmed data is read. The value read from this register points to one of the seven OTP banks, which is then loaded into RAM.

OTP MEMORY BANKS

There are four one-time programmable (OTP) bank selection registers: BANK SEL1, BANK SEL2, BANK SEL3, and BANK SEL4. Bank selection may be set four times by programming the BANK SELx registers in order (1, 2, 3, 4). The default OTP bank used on POR is the location stored in the last programmed BANK SELx register. Therefore, if programmed, BANK SEL4 always has priority over lower-numbered bank select registers.

The PGA308 contains seven OTP user memory banks. All seven of these banks may be independently programmed. However, the default bank at POR can be set only four times. The seven possible OTP user memory banks allow an end product with a microcontroller interface between the end-user and the PGA308 to select from up to seven factory pre-programmed configurations. It also provides total user flexibility for any other configuration through software communication over the One-Wire interface (1W pin). This flexibility allows no-scrap recovery from miscalibration situations.

PGA308 TRANSFER FUNCTION

Equation 1 shows the mathematical expression that is used to compute the output voltage, V_{OUT} . This equation can also be rearranged algebraically to solve for different terms. For example, during calibration, this equation is rearranged to solve for V_{IN} .

$$V_{OUT} = [(\text{mux_sign} \cdot V_{IN} + V_{\text{Coarse_Offset}}) \cdot \text{GI} + V_{\text{Zero_DAC}}] \cdot \text{GD} \cdot \text{GO} \quad (1)$$

Where:

mux_sign: This term changes the polarity of the input signal; value is ± 1

V_{IN}: The input signal for the PGA308; $V_{IN1} = V_{INP}$, $V_{IN2} = V_{INN}$

V_{Coarse_Offset}: The coarse offset DAC output voltage

GI: Input stage gain

V_{Zero_DAC}: Zero DAC output voltage

GD: Gain DAC

GO: Output stage gain

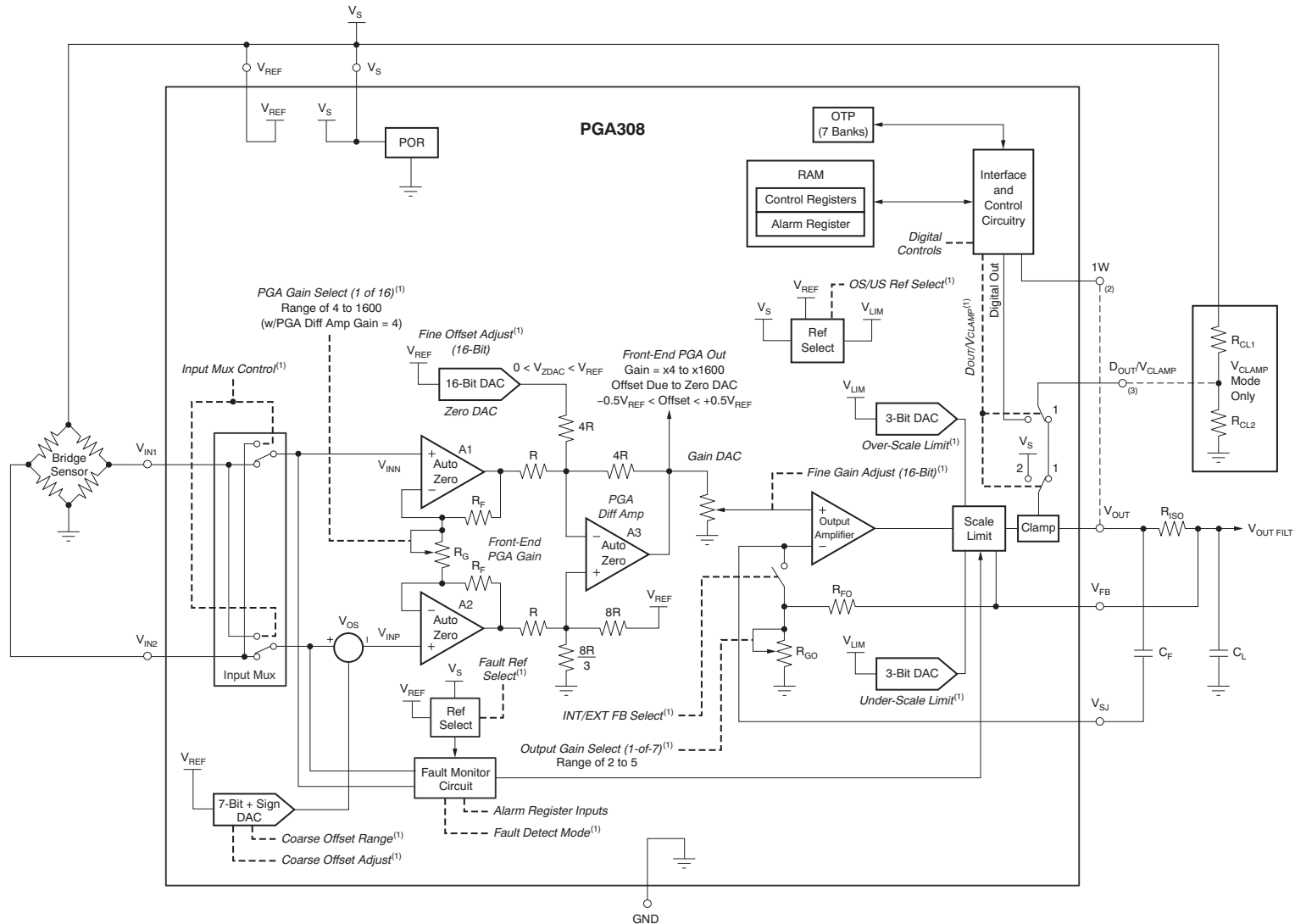

- NOTES: (1) User-adjustable feature.
 (2) Optional connection; see the *One-Wire Operation with 1W Connected to V_{OUT}* section for more information.
 (3) Optional connection; see the PGA308 User's Guide for more information.

Figure 37. Detailed Block Diagram

REVISION HISTORY

NOTE: Page numbers for previous revisions may differ from page numbers in the current version.

Changes from Revision A (April, 2009) to Revision B	Page
• Updated front page format to current standards	1
• Added PGA Transfer Function section	18

PACKAGING INFORMATION

Orderable part number	Status (1)	Material type (2)	Package Pins	Package qty Carrier	RoHS (3)	Lead finish/ Ball material (4)	MSL rating/ Peak reflow (5)	Op temp (°C)	Part marking (6)
PGA308AIDGSR	Active	Production	VSSOP (DGS) 10	2500 LARGE T&R	Yes	NIPDAUAG SN	Level-2-260C-1 YEAR	-40 to 125	P30A
PGA308AIDGSR.A	Active	Production	VSSOP (DGS) 10	2500 LARGE T&R	Yes	SN	Level-2-260C-1 YEAR	-40 to 125	P30A
PGA308AIDGSRG4	Active	Production	VSSOP (DGS) 10	2500 LARGE T&R	Yes	NIPDAUAG	Level-2-260C-1 YEAR	-40 to 125	P30A
PGA308AIDGSRG4.A	Active	Production	VSSOP (DGS) 10	2500 LARGE T&R	Yes	NIPDAUAG	Level-2-260C-1 YEAR	-40 to 125	P30A
PGA308AIDGST	Active	Production	VSSOP (DGS) 10	250 SMALL T&R	Yes	NIPDAUAG SN	Level-2-260C-1 YEAR	-40 to 125	P30A
PGA308AIDGST.A	Active	Production	VSSOP (DGS) 10	250 SMALL T&R	Yes	SN	Level-2-260C-1 YEAR	-40 to 125	P30A
PGA308AIDRKR	Active	Production	VSON (DRK) 10	3000 LARGE T&R	Yes	NIPDAU	Level-2-260C-1 YEAR	-40 to 125	P30B
PGA308AIDRKR.A	Active	Production	VSON (DRK) 10	3000 LARGE T&R	Yes	NIPDAU	Level-2-260C-1 YEAR	-40 to 125	P30B
PGA308AIDRKT	Active	Production	VSON (DRK) 10	250 SMALL T&R	Yes	NIPDAU	Level-2-260C-1 YEAR	-40 to 125	P30B
PGA308AIDRKT.A	Active	Production	VSON (DRK) 10	250 SMALL T&R	Yes	NIPDAU	Level-2-260C-1 YEAR	-40 to 125	P30B
PGA308AIDRKTG4	Active	Production	VSON (DRK) 10	250 SMALL T&R	Yes	NIPDAU	Level-2-260C-1 YEAR	-40 to 125	P30B
PGA308AIDRKTG4.A	Active	Production	VSON (DRK) 10	250 SMALL T&R	Yes	NIPDAU	Level-2-260C-1 YEAR	-40 to 125	P30B

(1) **Status:** For more details on status, see our [product life cycle](#).

(2) **Material type:** When designated, preproduction parts are prototypes/experimental devices, and are not yet approved or released for full production. Testing and final process, including without limitation quality assurance, reliability performance testing, and/or process qualification, may not yet be complete, and this item is subject to further changes or possible discontinuation. If available for ordering, purchases will be subject to an additional waiver at checkout, and are intended for early internal evaluation purposes only. These items are sold without warranties of any kind.

(3) **RoHS values:** Yes, No, RoHS Exempt. See the [TI RoHS Statement](#) for additional information and value definition.

(4) **Lead finish/Ball material:** Parts may have multiple material finish options. Finish options are separated by a vertical ruled line. Lead finish/Ball material values may wrap to two lines if the finish value exceeds the maximum column width.

(5) **MSL rating/Peak reflow:** The moisture sensitivity level ratings and peak solder (reflow) temperatures. In the event that a part has multiple moisture sensitivity ratings, only the lowest level per JEDEC standards is shown. Refer to the shipping label for the actual reflow temperature that will be used to mount the part to the printed circuit board.

(6) **Part marking:** There may be an additional marking, which relates to the logo, the lot trace code information, or the environmental category of the part.

Multiple part markings will be inside parentheses. Only one part marking contained in parentheses and separated by a "-" will appear on a part. If a line is indented then it is a continuation of the previous line and the two combined represent the entire part marking for that device.

Important Information and Disclaimer:The information provided on this page represents TI's knowledge and belief as of the date that it is provided. TI bases its knowledge and belief on information provided by third parties, and makes no representation or warranty as to the accuracy of such information. Efforts are underway to better integrate information from third parties. TI has taken and continues to take reasonable steps to provide representative and accurate information but may not have conducted destructive testing or chemical analysis on incoming materials and chemicals. TI and TI suppliers consider certain information to be proprietary, and thus CAS numbers and other limited information may not be available for release.

In no event shall TI's liability arising out of such information exceed the total purchase price of the TI part(s) at issue in this document sold by TI to Customer on an annual basis.

OTHER QUALIFIED VERSIONS OF PGA308 :

- Automotive : [PGA308-Q1](#)

NOTE: Qualified Version Definitions:

- Automotive - Q100 devices qualified for high-reliability automotive applications targeting zero defects

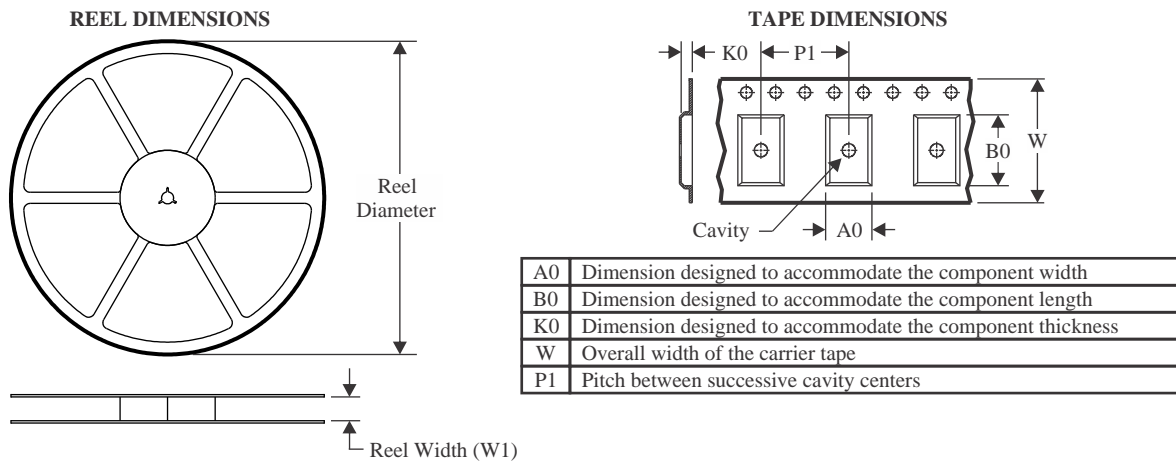
TAPE AND REEL INFORMATION

QUADRANT ASSIGNMENTS FOR PIN 1 ORIENTATION IN TAPE

*All dimensions are nominal

Device	Package Type	Package Drawing	Pins	SPQ	Reel Diameter (mm)	Reel Width W1 (mm)	A0 (mm)	B0 (mm)	K0 (mm)	P1 (mm)	W (mm)	Pin1 Quadrant
PGA308AIDGSR	VSSOP	DGS	10	2500	330.0	12.4	5.25	3.35	1.25	8.0	12.0	Q1
PGA308AIDGSRG4	VSSOP	DGS	10	2500	330.0	12.4	5.3	3.4	1.4	8.0	12.0	Q1
PGA308AIDGST	VSSOP	DGS	10	250	330.0	12.4	5.25	3.35	1.25	8.0	12.0	Q1
PGA308AIDRKR	VSON	DRK	10	3000	330.0	12.4	3.3	4.3	1.1	8.0	12.0	Q2
PGA308AIDRKT	VSON	DRK	10	250	180.0	12.4	3.3	4.3	1.1	8.0	12.0	Q2
PGA308AIDRKTG4	VSON	DRK	10	250	180.0	12.4	3.3	4.3	1.1	8.0	12.0	Q2

TAPE AND REEL BOX DIMENSIONS

*All dimensions are nominal

Device	Package Type	Package Drawing	Pins	SPQ	Length (mm)	Width (mm)	Height (mm)
PGA308AIDGSR	VSSOP	DGS	10	2500	366.0	364.0	50.0
PGA308AIDGSRG4	VSSOP	DGS	10	2500	366.0	364.0	50.0
PGA308AIDGST	VSSOP	DGS	10	250	366.0	364.0	50.0
PGA308AIDRKR	VSON	DRK	10	3000	353.0	353.0	32.0
PGA308AIDRKT	VSON	DRK	10	250	213.0	191.0	35.0
PGA308AIDRKTG4	VSON	DRK	10	250	213.0	191.0	35.0

DGS0010A



PACKAGE OUTLINE

VSSOP - 1.1 mm max height

SMALL OUTLINE PACKAGE



4221984/A 05/2015

NOTES:

1. All linear dimensions are in millimeters. Any dimensions in parenthesis are for reference only. Dimensioning and tolerancing per ASME Y14.5M.
2. This drawing is subject to change without notice.
3. This dimension does not include mold flash, protrusions, or gate burrs. Mold flash, protrusions, or gate burrs shall not exceed 0.15 mm per side.
4. This dimension does not include interlead flash. Interlead flash shall not exceed 0.25 mm per side.
5. Reference JEDEC registration MO-187, variation BA.

EXAMPLE BOARD LAYOUT

DGS0010A

VSSOP - 1.1 mm max height

SMALL OUTLINE PACKAGE



LAND PATTERN EXAMPLE
SCALE:10X



SOLDER MASK DETAILS
NOT TO SCALE

4221984/A 05/2015

NOTES: (continued)

6. Publication IPC-7351 may have alternate designs.
7. Solder mask tolerances between and around signal pads can vary based on board fabrication site.

EXAMPLE STENCIL DESIGN

DGS0010A

VSSOP - 1.1 mm max height

SMALL OUTLINE PACKAGE



SOLDER PASTE EXAMPLE
BASED ON 0.125 mm THICK STENCIL
SCALE:10X

4221984/A 05/2015

NOTES: (continued)

8. Laser cutting apertures with trapezoidal walls and rounded corners may offer better paste release. IPC-7525 may have alternate design recommendations.
9. Board assembly site may have different recommendations for stencil design.

EXAMPLE BOARD LAYOUT

DRK0010A

VSON - 1 mm max height

PLASTIC SMALL OUTLINE - NO LEAD

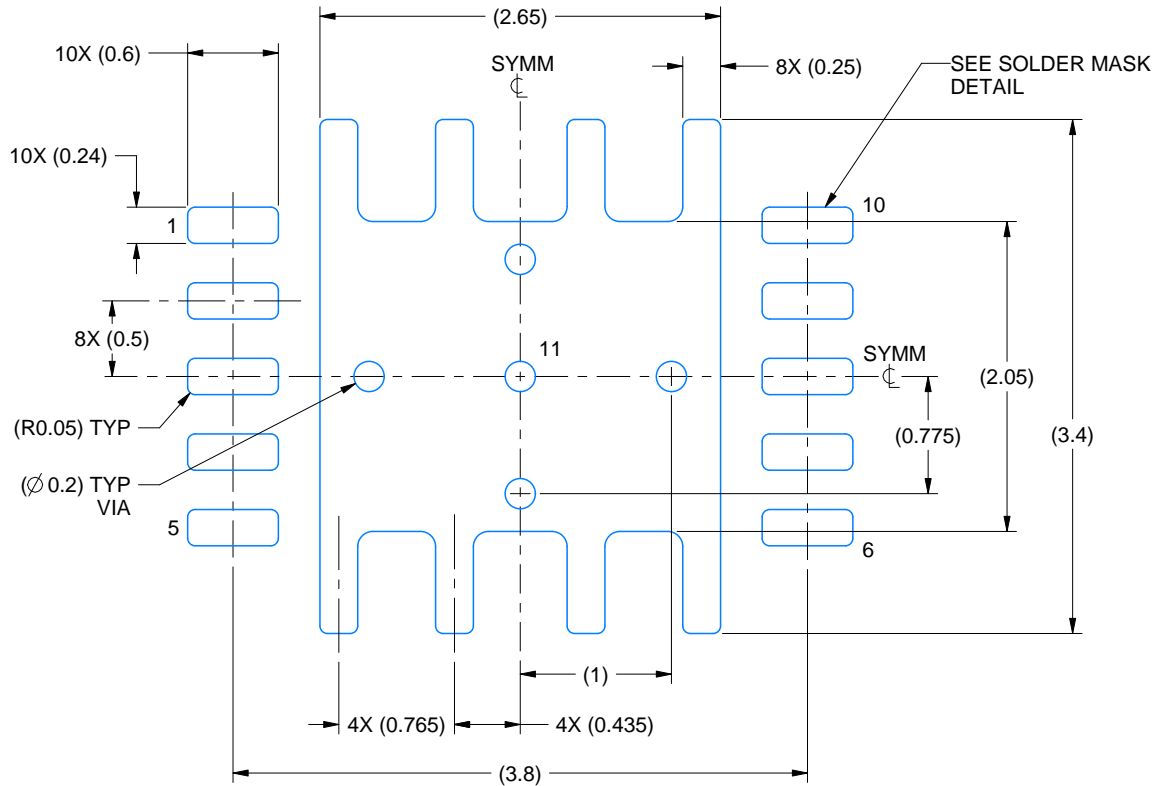

LAND PATTERN EXAMPLE
EXPOSED METAL SHOWN
SCALE: 20X

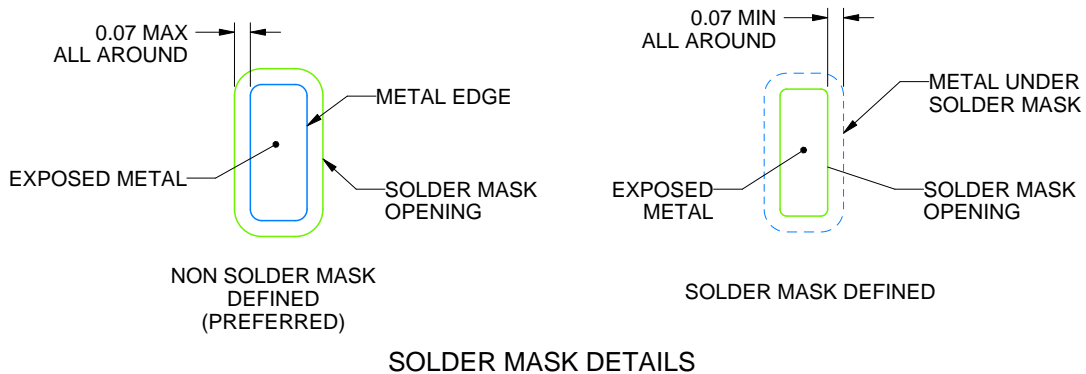

4218888/A 02/2025

NOTES: (continued)

4. This package is designed to be soldered to a thermal pad on the board. For more information, see Texas Instruments literature number SLUA271 (www.ti.com/lit/slua271).
5. Vias are optional depending on application, refer to device data sheet. If any vias are implemented, refer to their locations shown on this view. It is recommended that vias under paste be filled, plugged or tented.

EXAMPLE STENCIL DESIGN

DRK0010A

VSON - 1 mm max height

PLASTIC SMALL OUTLINE - NO LEAD

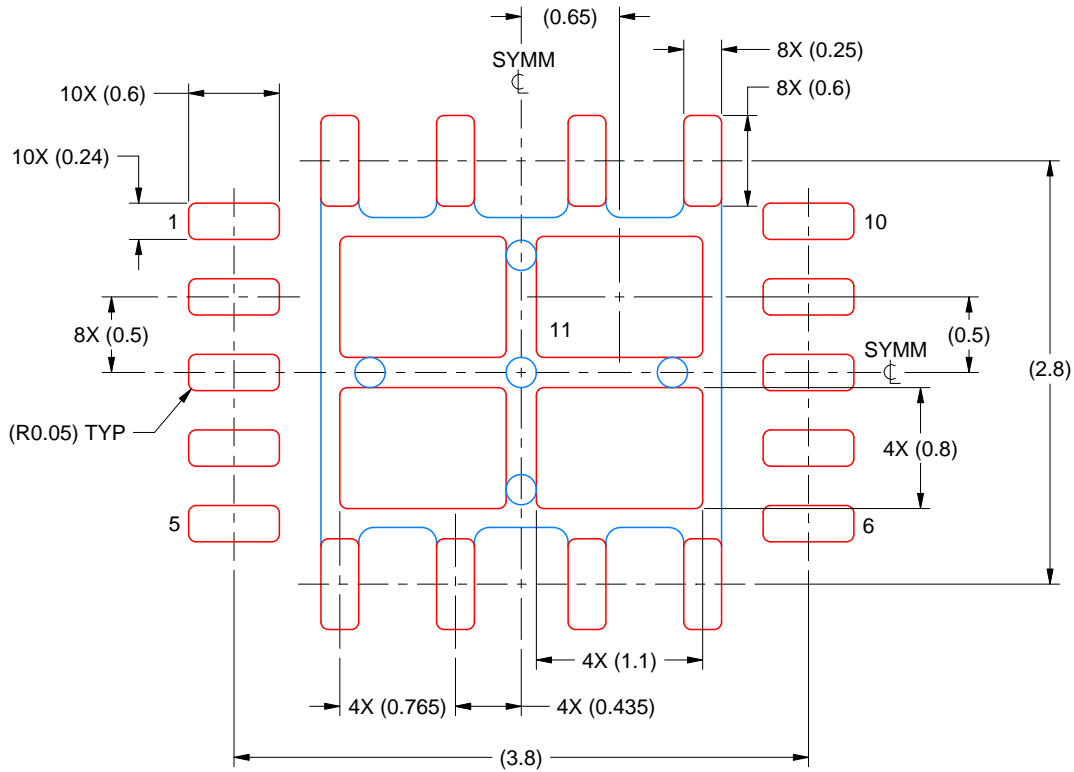

SOLDER PASTE EXAMPLE
BASED ON 0.125 MM THICK STENCIL
SCALE: 20X

EXPOSED PAD 11
70% PRINTED SOLDER COVERAGE BY AREA UNDER PACKAGE

4218888/A 02/2025

NOTES: (continued)

6. Laser cutting apertures with trapezoidal walls and rounded corners may offer better paste release. IPC-7525 may have alternate design recommendations.

IMPORTANT NOTICE AND DISCLAIMER

TI PROVIDES TECHNICAL AND RELIABILITY DATA (INCLUDING DATASHEETS), DESIGN RESOURCES (INCLUDING REFERENCE DESIGNS), APPLICATION OR OTHER DESIGN ADVICE, WEB TOOLS, SAFETY INFORMATION, AND OTHER RESOURCES "AS IS" AND WITH ALL FAULTS, AND DISCLAIMS ALL WARRANTIES, EXPRESS AND IMPLIED, INCLUDING WITHOUT LIMITATION ANY IMPLIED WARRANTIES OF MERCHANTABILITY, FITNESS FOR A PARTICULAR PURPOSE OR NON-INFRINGEMENT OF THIRD PARTY INTELLECTUAL PROPERTY RIGHTS.

These resources are intended for skilled developers designing with TI products. You are solely responsible for (1) selecting the appropriate TI products for your application, (2) designing, validating and testing your application, and (3) ensuring your application meets applicable standards, and any other safety, security, regulatory or other requirements.

These resources are subject to change without notice. TI grants you permission to use these resources only for development of an application that uses the TI products described in the resource. Other reproduction and display of these resources is prohibited. No license is granted to any other TI intellectual property right or to any third party intellectual property right. TI disclaims responsibility for, and you fully indemnify TI and its representatives against any claims, damages, costs, losses, and liabilities arising out of your use of these resources.

TI's products are provided subject to [TI's Terms of Sale](#), [TI's General Quality Guidelines](#), or other applicable terms available either on [ti.com](#) or provided in conjunction with such TI products. TI's provision of these resources does not expand or otherwise alter TI's applicable warranties or warranty disclaimers for TI products. Unless TI explicitly designates a product as custom or customer-specified, TI products are standard, catalog, general purpose devices.

TI objects to and rejects any additional or different terms you may propose.

Copyright © 2025, Texas Instruments Incorporated

Last updated 10/2025