

Using the TPS51206EVM-745, 2-A Peak Sink/Source DDR Termination Regulator With VTTREF Buffered Reference for DDR2, DDR3, DDR3L, and DDR4

The TPS51206EVM-745 evaluation module (EVM) uses the TPS51206. The TPS51206 is a sink/source double data rate (DDR) termination regulator with VTTREF buffered reference output. It is specifically designed for low-input voltage, low cost, low external component count systems where space is a key consideration.

Contents

1	Description	3
	1.1 Typical Applications	3
	1.2 Features	3
2	Electrical Performance Specifications	3
3	Schematics	5
4	Test Setup	7
	4.1 Test Equipment	7
	4.2 Recommended Wire Gauge	7
	4.3 Recommended Test Setup	7
5	Configurations	8
	5.1 Transient Load Selection	8
	5.2 Source Transient Load Selection	9
	5.3 Sink Transient Load Selection	9
	5.4 S1, S2 Enable Selection	9
6	Test Procedure	9
	6.1 DDR2 (0.9VTT)/DDR3 (0.75VTT)/DDR3L (0.675VTT)/DDR4 (0.6VTT) Source Load Regulation	9
	6.2 DDR2 (0.9VTT)/DDR3 (0.75VTT)/DDR3L (0.675VTT)/DDR4 (0.6VTT) Sink/Source Current Transient	10
	6.3 DDR2 (0.9VTT)/DDR3 (0.75VTT)/DDR3L (0.675VTT)/DDR4 (0.6VTT) Loop Stability Measurement	10
	6.4 List of Test Points	10
	6.5 Equipment Shutdown	11
7	Performance Data and Typical Characteristic Curves	11
	7.1 VTT Load Regulation	11
	7.2 VTTREF Load Regulation	13
	7.3 VTT Dropout Voltage	15
	7.4 VTT Sink/Source Load Transient	17
	7.5 DDR3(0.75VTT) S5 Enable Turnon/Turnoff	19
	7.6 DDR3 (0.75VTT) S3 Enable Turnon/Turnoff	20
	7.7 DDR3 (0.75VTT) Bode Plot	21
8	EVM Assembly Drawing and PCB Layout	21
9	Bill of Materials	25

List of Figures

1	TPS51206EVM-745, Schematic 1	5
2	TPS51206EVM-745, Schematic 2	6

3	TPS51206EVM-745 Recommended Test Setup	8
4	DDR2(0.9VTT) Load Regulation	11
5	DDR3 (0.75VTT) Load Regulation	11
6	DDR3L (0.675VTT) Load Regulation	12
7	DDR4 (0.6VTT) Load Regulation.....	12
8	DDR2 (0.9VTTREF) Load Regulation	13
9	DDR3 (0.75VTTREF) Load Regulation.....	13
10	DDR3L (0.675VTTREF) Load Regulation	14
11	DDR4 (0.6VTTREF) Load Regulation	14
12	DDR2 (0.9VTT) Dropout Voltage	15
13	DDR3 (0.75VTT) Dropout Voltage	15
14	DDR3L (0.675VTT) Dropout Voltage	16
15	DDR4 (0.6VTT) Dropout Voltage	16
16	DDR2 (0.9VTT) 1.8-A Sink/Source	17
17	DDR3 (0.75VTT) 1.5-A Sink/Source	17
18	DDR3L (0.75VTT) 1.35-A Sink/Source	18
19	DDR4 (0.6VTT) 1.2-A Sink/Source.....	18
20	DDR3 (0.75VTT) S5 Enable Turnon	19
21	DDR3 (0.75VTT) S5 Enable Turnoff	19
22	DDR3 (0.75VTT) S3 Enable Turnon	20
23	DDR3 (0.75VTT) S3 Enable Turnoff	20
24	DDR3 Bode plot	21
25	TPS51206EVM-745 Top Layer Assembly Drawing.....	22
26	TPS51206EVM-745 Top Layer	22
27	TPS51206EVM-745 Internal Layer 1	23
28	TPS51206EVM-745 Internal Layer 2	23
29	TPS51206EVM-745 Bottom Layer	24
30	TPS51206EVM-745 Bottom Layer Assembly.....	24

List of Tables

1	TPS51206EVM-745 Electrical Performance Specifications	3
2	Transient Load Selection	8
3	Source Transient Load Selection	9
4	Sink Transient Load Selection	9
5	S3, S5 Enable Selection	9
6	Functions of Each Test Point	10
7	Bill of Materials	25

1 Description

The TPS51206EVM-745 is designed to provide proper termination voltage and a 10-mA buffered reference voltage for DDR memory which covers DDR2 (0.9VTT), DDR3 (0.75VTT), DDR3L (0.675VTT) and DDR4 (0.6VTT) specifications with minimal external components.

1.1 Typical Applications

- DDR2/DDR3/DDR3L/DDR4 memory power supplies
- SSTL_18, SSTL_15, SSTL_135, and HSTL termination

1.2 Features

- VDD voltage: support 5-V rail and 3.3-V rail
- VLDOIN, VDDQ voltage range: 1.2 V–1.8 V
- Build-in, onboard transient load (with both sinking and sourcing capability) to emulate the sink/source transient behavior which helps to evaluate the dynamic performance. For ease of use, both load step and timing of transient can be modified by onboard resistors.
 - DDR2 (0.9VTT): ± 1.8 -A sink/source transient load
 - DDR3 (0.75VTT): ± 1.5 -A sink/source transient load
 - DDR3L (0.675VTT): ± 1.35 -A sink/source transient load
 - DDR4 (0.6VTT): ± 1.2 -A sink/source transient load
- Switch S1, S2 for S3 and S5 Enable function
- Convenient test points for probing VTT, VTTREF, CLK_IN and loop response testing
- Four-layer, printed-circuit board (PCB) with all the components on the bottom side

2 Electrical Performance Specifications

Table 1. TPS51206EVM-745 Electrical Performance Specifications⁽¹⁾

Parameter	Test Conditions	Min	Typ	Max	Units
Input Characteristics					
VDD voltage range			5/3.3		V
VDDQ voltage range		1.2		1.8	V
VLDOIN voltage range		VTT+0.4		3.5	V
VTT and VTTREF Termination Voltage					
DDR2 (0.9VTT)	VTT		0.9		V
	VTTREF		0.9		
DDR3 (0.75VTT)	VTT		0.75		V
	VTTREF		0.75		V
DDR3L (0.675VTT)	VTT		0.675		V
	VTTREF		0.675		V
DDR4 (0.6VTT)	VTT		0.6		V
	VTTREF		0.6		V
VTT and VTTREF Termination Current					
VTT termination current(I_{VTT})	For DDR2(0.9VTT) and DDR3(0.75VTT)	-2		2	A
	For DDR3L(0.675VTT) and DDR4(0.6VTT)	-1.5		1.5	
VTTREF termination current(I_{VTTREF})		-10		10	mA
VTT Current Limit					
VTT sink current limit		2			A
VTT source current limit		2			A

⁽¹⁾ Note: Jumpers set to default locations, See [Section 5](#) of this user's guide

Table 1. TPS51206EVM-745 Electrical Performance Specifications⁽¹⁾ (continued)

Parameter	Test Conditions	Min	Typ	Max	Units
VTT and VTTREF Termination Voltage Tolerance					
VTT termination voltage tolerance	$ I_{VTT} < 2 \text{ A}, 1.4 \text{ V} \leq V_{VDDQSNS} \leq 1.8 \text{ V}$	-40		40	mV
	$ I_{VTT} < 1.5 \text{ A}, 1.2 \text{ V} \leq V_{VDDQSNS} < 1.4 \text{ V}$	-40		40	mV
VTT termination voltage tolerance	$ I_{VTTREF} < 10 \text{ mA}, 1.5 \text{ V} \leq V_{VDDQSNS} \leq 1.8 \text{ V}$	49%		51%	
	$ I_{VTTREF} < 10 \text{ mA}, 1.2 \text{ V} \leq V_{VDDQSNS} < 1.5 \text{ V}$	48.75%		51.25%	
Operating temperature			25		°C

3 Schematics

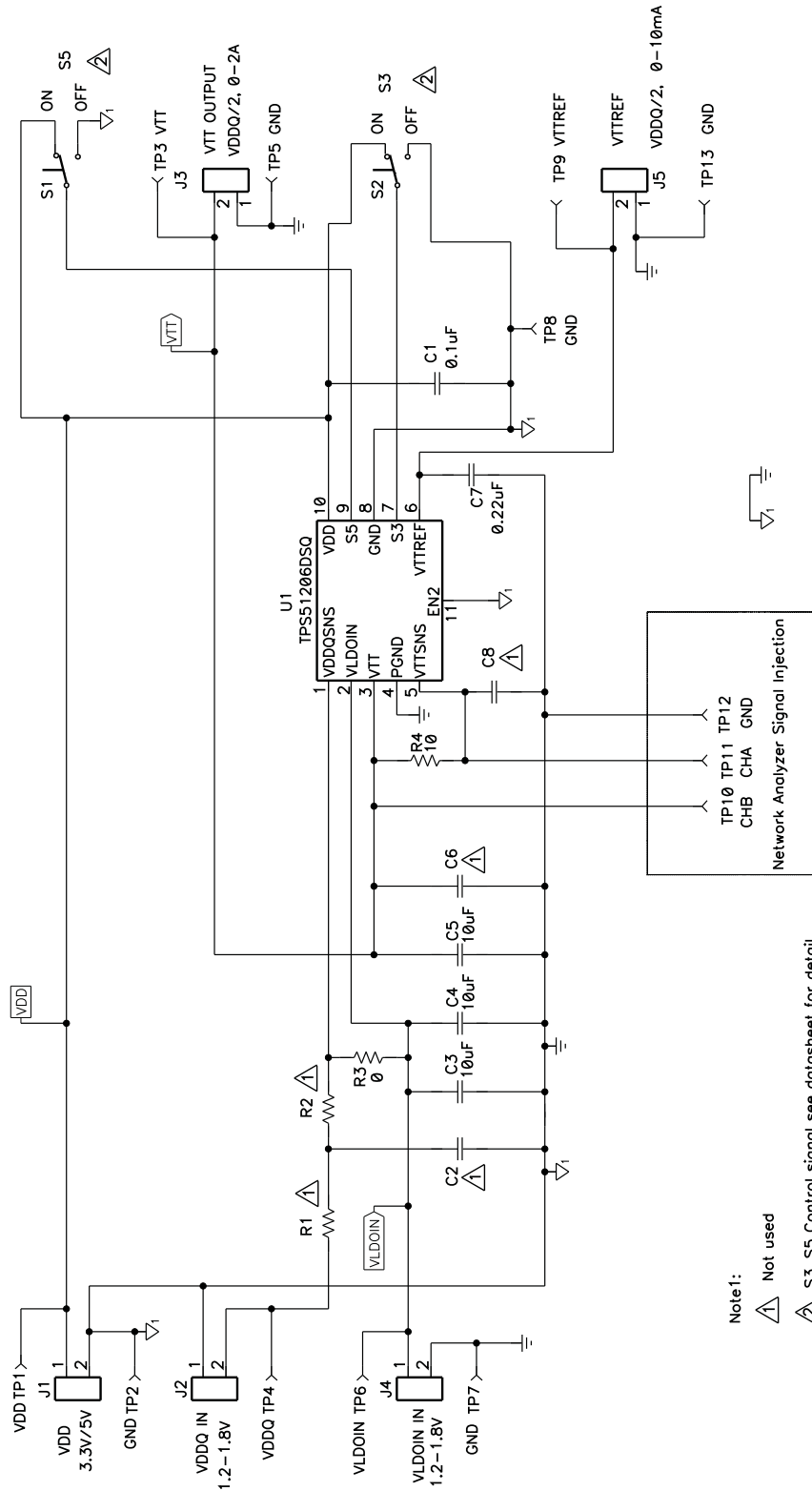

Note1:
 Not used
 S3, S5 Control signal see datasheet for detail

Figure 1. TPS51206EVM-745, Schematic 1

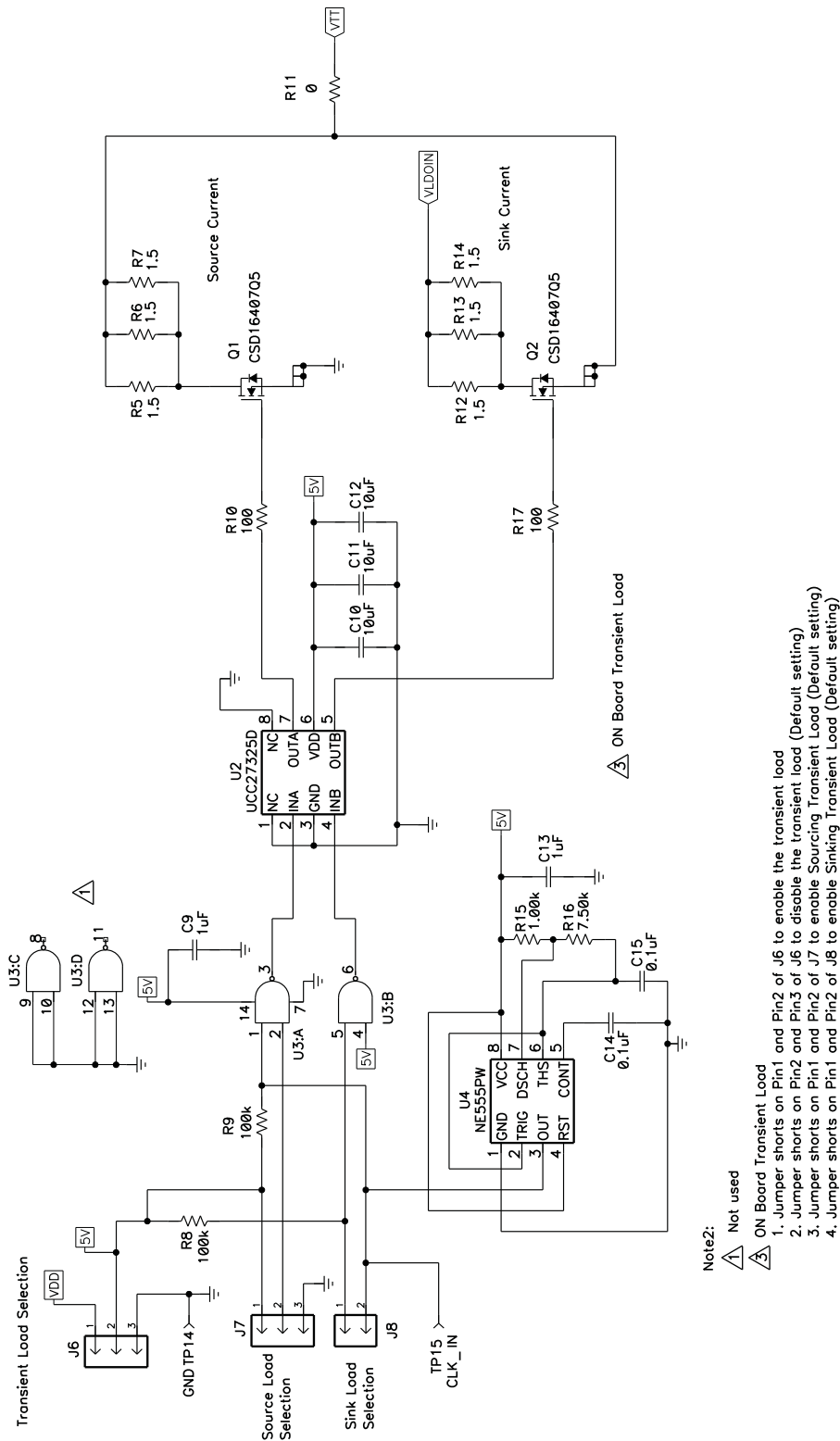

Note2:
 ⚠ Not used
 ⚠ ON Board Transient Load
 ⚠ ON Board Transient Load
 1. Jumper shorts on Pin1 and Pin2 of J6 to enable the transient load
 2. Jumper shorts on Pin2 and Pin3 of J6 to disable the transient load (Default setting)
 3. Jumper shorts on Pin1 and Pin2 of J7 to enable Sourcing Transient Load (Default setting)
 4. Jumper shorts on Pin1 and Pin2 of J8 to enable Sinking Transient Load (Default setting)

Figure 2. TPS51206EVM-745, Schematic 2

4 Test Setup

4.1 Test Equipment

4.1.1 Voltage Source

- **VDD:** The VDD dc Source1 must be a 0-V to 10-V variable dc source capable of supplying 1 Adc.
- **VLDOIN:** The VLDOIN DC Source2 must be a 0-V to 10-V variable dc source capable of supplying 10 Adc.

4.1.2 Meters

- V1: dc voltmeter for VDD at TP1 (VDD) and TP2 (GND)
- V2: dc voltmeter for VLDOIN at TP6 (VLDOIN) and TP7 (GND)
- V3: dc voltmeter for VTT at TP3 (VTT) and TP5 (GND)
- V4: dc voltmeter for VTTREF at TP9 (VTTREF) and TP13 (GND)

4.1.3 Load

- **LOAD:** The VTT load must be an electronic constant-current load capable of 0 A to 10 A at 0.9 Vdc

4.1.4 Oscilloscope

A digital or analog oscilloscope can be used to measure VTT sink/source current transient. The oscilloscope must be set for 1-M Ω impedance, 20-MHz bandwidth, ac coupling, 200- μ s/division horizontal resolution, 50-mV/division vertical resolution for VTT transient test. Test point TP3 (VTT) and TP5 (GND) can be used to measure VTT transient. Set horizontal cursor to measure transient load regulation.

4.2 Recommended Wire Gauge

4.2.1 VDD dc Source1 to J1

The connection between the voltage dc Source1 and J1 of the EVM can carry as much as 0.5-Adc current. The recommended wire size is AWG 18 with the total length of wire less than 4 feet (2-foot input, 2-foot return).

4.2.2 VLDOIN dc Source2 to J4

The connection between the voltage dc Source2 and J4 of the EVM can carry as much as 5-Adc current. The recommended wire size is AWG 16 with the total length of wire less than 4 feet (2-foot input, 2-foot return).

4.2.3 VTT Load to J3

The connection between the VTT load and J3 of the EVM can carry as much as 5-Adc current. The recommended wire size is AWG 16 with the total length of wire less than 4 feet (2-foot input, 2-foot return).

4.3 Recommended Test Setup

[Figure 3](#) is the recommended test setup to evaluate the TPS51206EVM-745. Working at an ESD workstation, ensure that any wrist straps, bootstraps, or mats are connected referencing the user to earth ground before power is applied to the EVM.

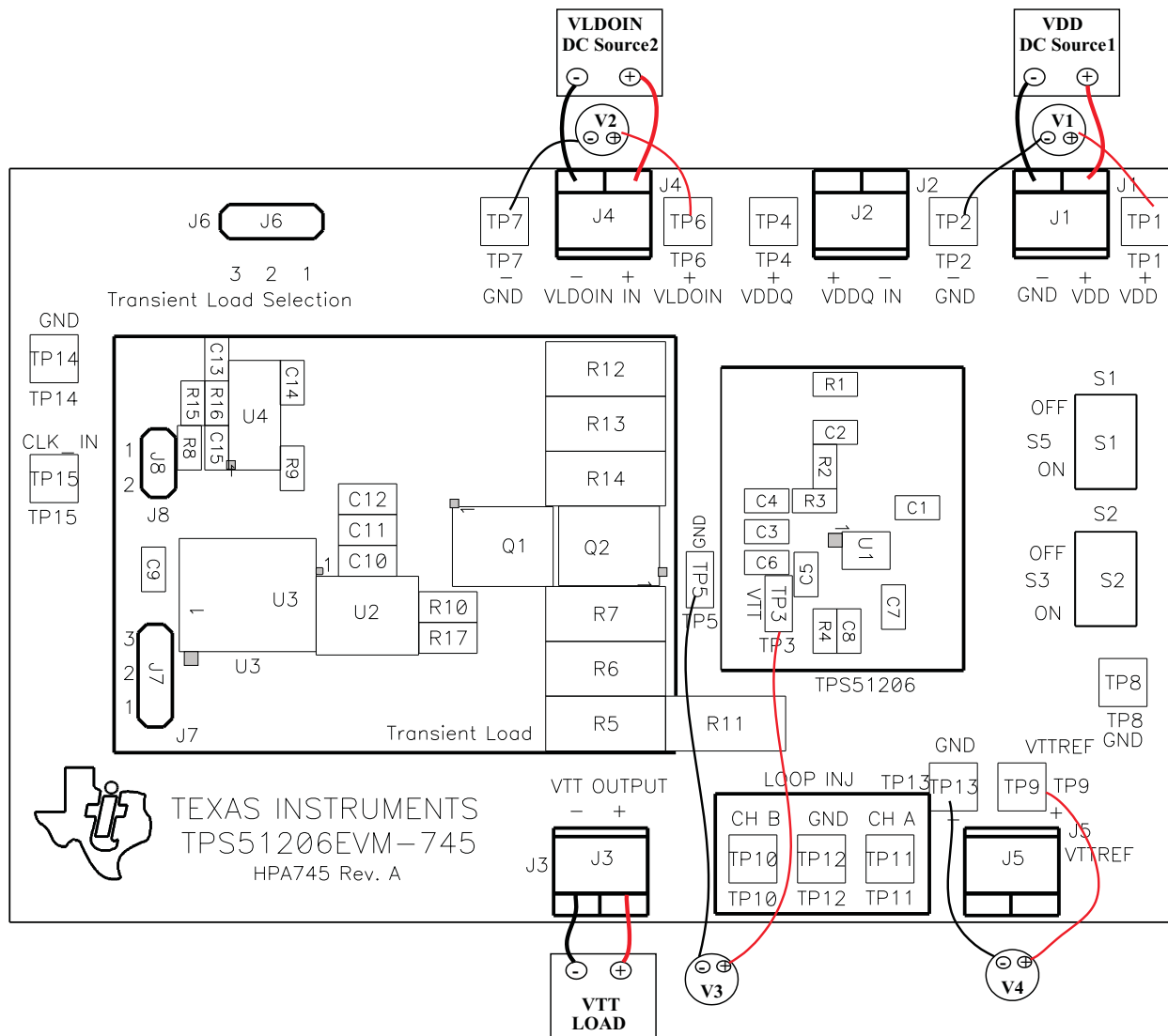

Figure 3. TPS51206EVM-745 Recommended Test Setup

5 Configurations

All jumper selections must be made prior to applying power to the EVM. Users can configure this EVM per the following configurations.

5.1 Transient Load Selection

The transient load selection can be set by J6.

Default setting: Jumper shorts on Pin2 and Pin3 of J6 to disable transient load.

Table 2. Transient Load Selection

Jumper Set to	Transient Load
1-2 pin shorted	Enable
2-3 pin shorted	Disable

5.2 Source Transient Load Selection

The source transient load selection can be set by J7.

Default setting: Jumper shorts on Pin1 and Pin2 of J7 to enable source transient load.

Table 3. Source Transient Load Selection

Jumper Set to	Transient Load
1-2 pin shorted	Enable
2-3 pin shorted	Disable

5.3 Sink Transient Load Selection

The sink transient load selection can be set by J8.

Default setting: Jumper shorts on Pin1 and Pin2 of J8 to enable sink transient load.

Table 4. Sink Transient Load Selection

Jumper Set to	Transient Load
1-2 pin shorted	Enable
No Jumper shorted	Disable

5.4 S1, S2 Enable Selection

The controller can be enabled and disabled by switch S1 and S2.

Default setting: Push S1 and S2 to the TOP (OFF position) to disable the controller.

Table 5. S3, S5 Enable Selection

S2 Switch(S3) Set to	S1 Switch(S5) Set to	VTTREF	VTT
ON position	ON position	ON	ON
OFF position	ON position	ON	OFF(High-Z)
OFF position	OFF position	OFF(Discharge)	OFF(Discharge)

6 Test Procedure

6.1 DDR2 (0.9VTT)/DDR3 (0.75VTT)/DDR3L (0.675VTT)/DDR4 (0.6VTT) Source Load Regulation

1. Ensure jumper shorts on Pin2 and Pin3 of J6.
2. Ensure jumper shorts on Pin1 and Pin2 of J7, J8.
3. Ensure switches S1 and S2 to OFF position.
4. Set VTT load to 0 A.
5. Increase VDD (VDD dc Source1) from 0 V to 5 V at J1. This is the bias supply needed for TPS51206 operation. Using V1, verify VDD voltage between 4.8 V and 5 V.
6. Increase VLDOIN voltage (VLDOIN dc Source2) from 0 V to 1.8 V for DDR2 or 1.5 V for DDR3 or 1.35 V for DDR3L at J4. This is the LDO input. Using V2, verify VLDOIN voltage.
7. Set switches S1, S2 to ON position.
8. Use V3, V4 to measure VTT, VTTREF voltage.
9. Increase load from 0 A to 1.5 A.
10. Verify V2 and adjust VLDOIN if necessary.
11. Use V3, V4 to measure VTT, VTTREF voltage.
12. Decrease load to 0 A.
13. Set switches S1, S2 to OFF position.

6.2 **DDR2 (0.9VTT)/DDR3 (0.75VTT)/DDR3L (0.675VTT)/DDR4 (0.6VTT) Sink/Source Current Transient**

1. Remove VTT load from J3.
2. Remove V3 from TP3 (VTT) and TP5 (GND).
3. Add scope probe on TP3 (VTT) and TP5 (GND).
4. Remove jumper on Pin2 and Pin3 of J6 and put this jumper on Pin1 and Pin2 of J6.
5. Set switches S1, S2 to ON position.
6. TPS51206 is now operating at sink/source load transient.
7. Verify V2 and adjust VLDOIN if necessary.
8. Use scope probe at TP3 (VTT) and TP5 (GND) to monitor VTT load transient operation, and use cursor to make measurement. The waveform is shown in [Section 7.4](#).
9. Set switch S1, S2 to OFF position.
10. Decrease dc source 1.2 V to 0 V.

6.3 **DDR2 (0.9VTT)/DDR3 (0.75VTT)/DDR3L (0.675VTT)/DDR4 (0.6VTT) Loop Stability Measurement**

TPS51206EVM-745 contains an R4 (10-Ω) series resistor in the feedback loop for loop response analysis.

1. Set up EVM as described in [Section 4](#) and [Figure 3](#).
2. Connect isolation transformer to test points marked TP11 and TP10.
3. Connect input signal amplitude measurement probe (channel A) to TP11. Connect output signal amplitude measurement probe (channel B) to TP10.
4. Connect ground lead of channel A and channel B to TP12.
5. Inject approximately 50-mV or less signal through the isolation transformer.
6. Sweep the frequency from 1 kHz to 1 MHz with 10-Hz or lower post filter. The control loop gain and phase margin can be measured.
7. Disconnect isolation transformer from bode plot test points before making other measurements. Signal injection into feedback may interfere with accuracy of other measurements.

6.4 **List of Test Points**

Table 6. Functions of Each Test Point

Test Points	Name	Description
TP1	VDD	Device power supply input (3.3 V or 5 V)
TP2	GND	Ground
TP3	VTT	VTT Output
TP4	VDDQ	VDDQSNS sense input, when VLDOIN is different from VDDQSNS voltage
TP5	GND	Ground
TP6	VLDOIN	Power supply input for VTT/VTTREF
TP7	GND	Ground
TP8	GND	Ground
TP9	VTTREF	VTTREF buffered reference output
TP10	CHB	Input B for loop injection
TP11	CHA	Input A for loop injection
TP12	GND	Ground
TP13	GND	Ground
TP14	GND	Ground
TP15	CLK_IN	Sink/source load transient timing signal

6.5 Equipment Shutdown

1. Shut down VDD dc Source1 and VLDOIN dc Source2
2. Shut down VTT load.
3. Shut down oscilloscope.

7 Performance Data and Typical Characteristic Curves

7.1 VTT Load Regulation

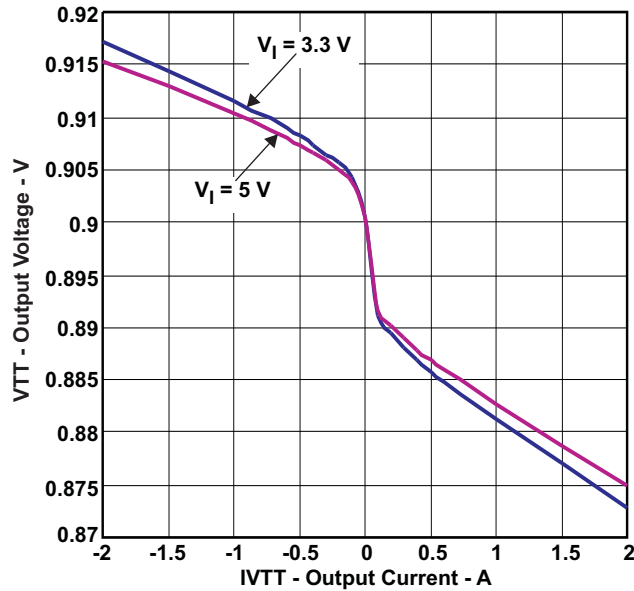

Figure 4. DDR2(0.9VTT) Load Regulation

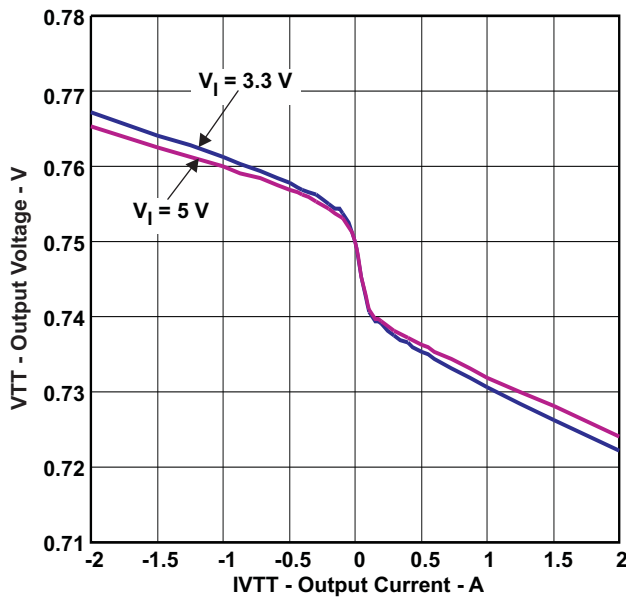

Figure 5. DDR3 (0.75VTT) Load Regulation

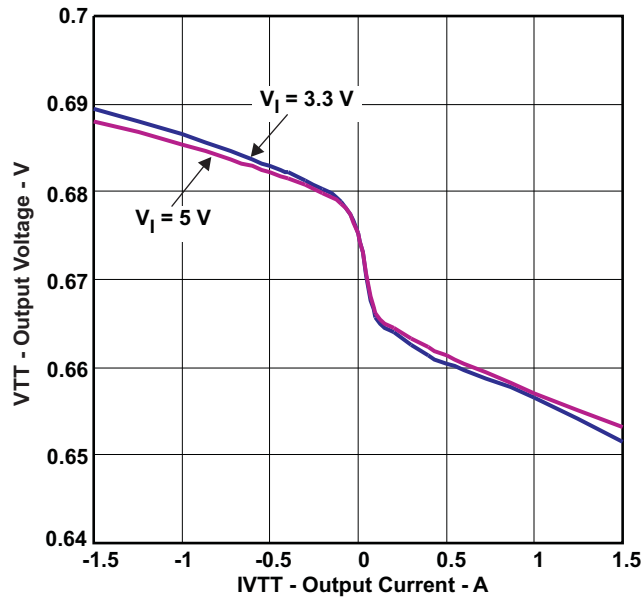

Figure 6. DDR3L (0.675VTT) Load Regulation

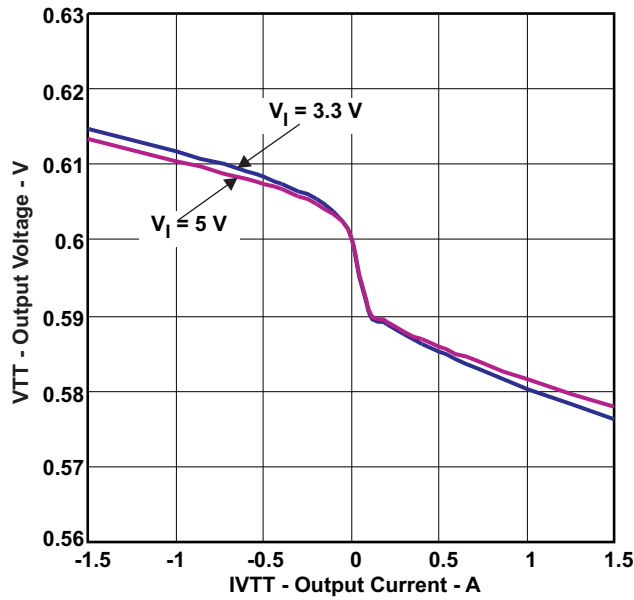

Figure 7. DDR4 (0.6VTT) Load Regulation

7.2 VTTREF Load Regulation

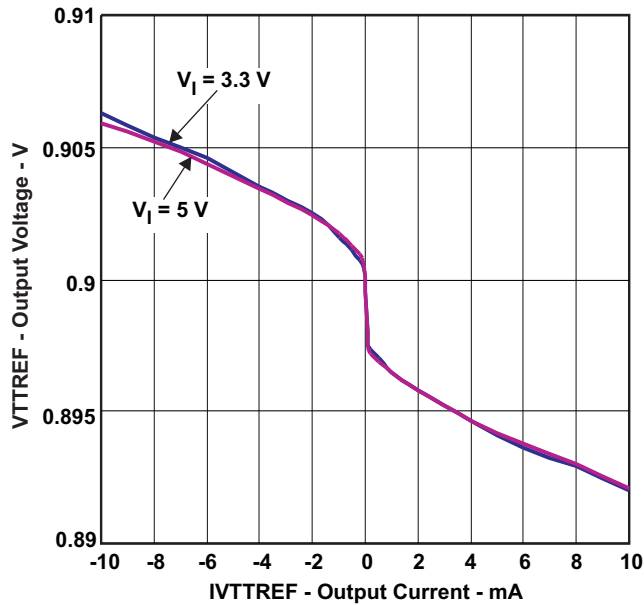

Figure 8. DDR2 (0.9VTTREF) Load Regulation

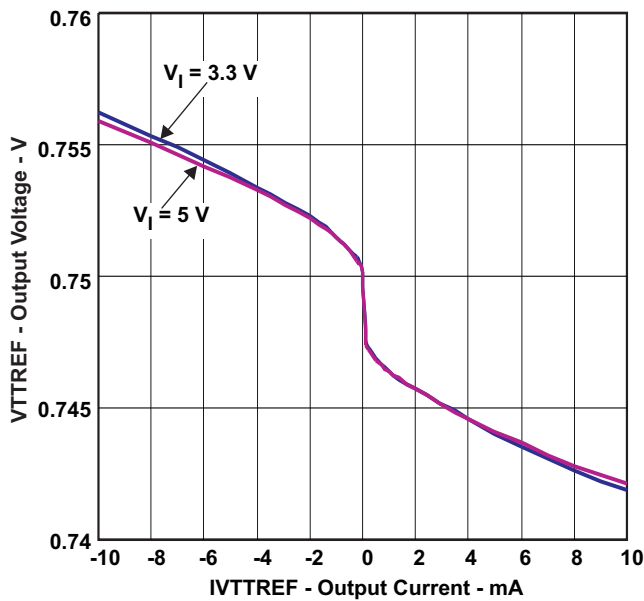

Figure 9. DDR3 (0.75VTTREF) Load Regulation

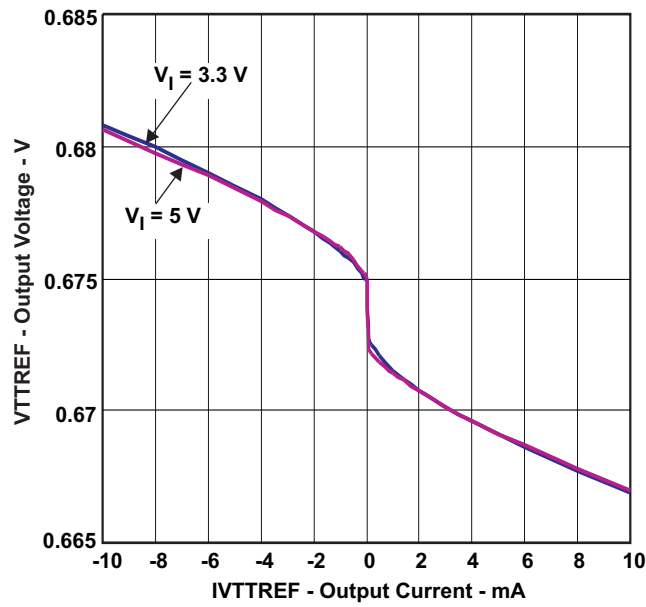

Figure 10. DDR3L (0.675VTTREF) Load Regulation

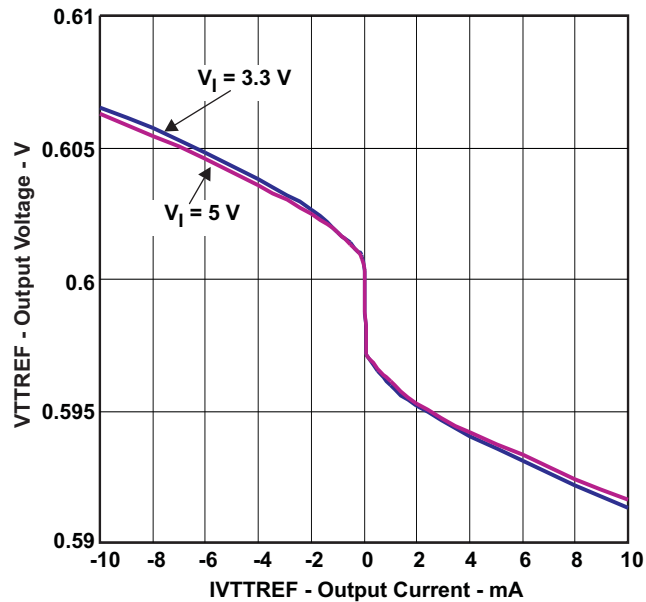

Figure 11. DDR4 (0.6VTTREF) Load Regulation

7.3 VTT Dropout Voltage

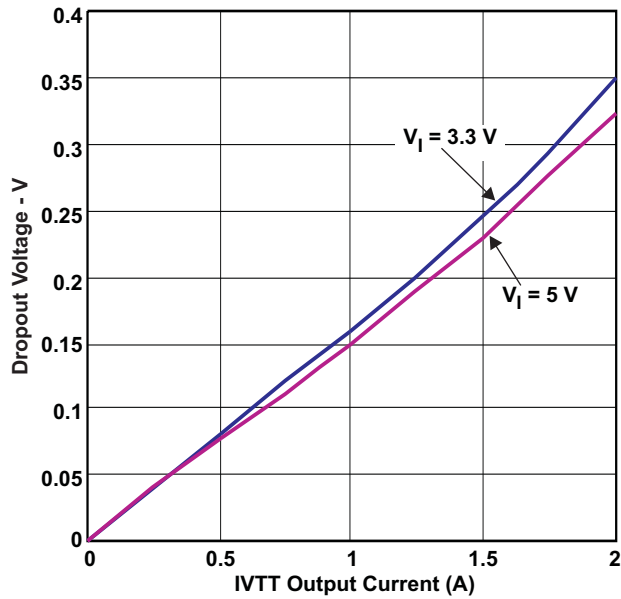

Figure 12. DDR2 (0.9VTT) Dropout Voltage

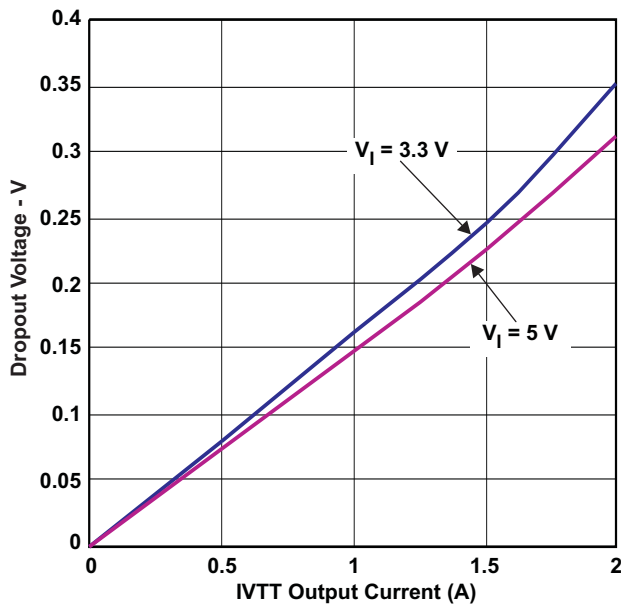

Figure 13. DDR3 (0.75VTT) Dropout Voltage

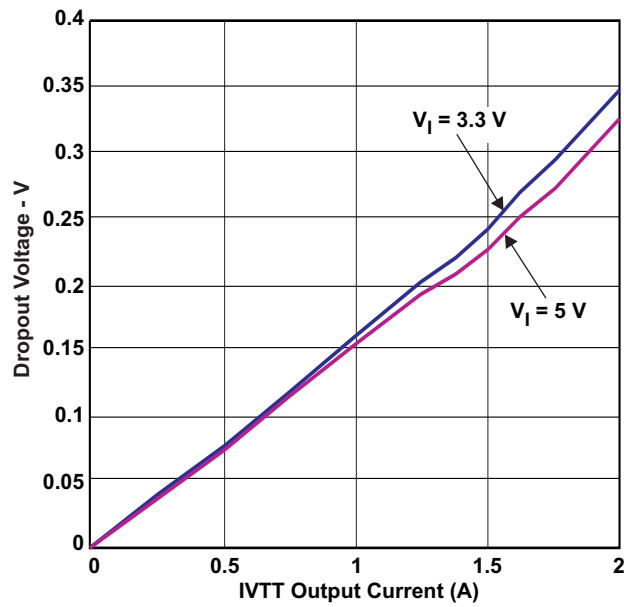

Figure 14. DDR3L (0.675VTT) Dropout Voltage

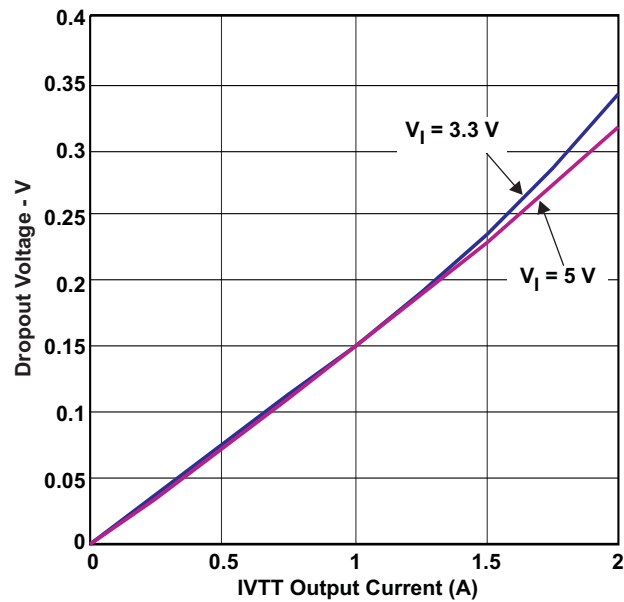

Figure 15. DDR4 (0.6VTT) Dropout Voltage

7.4 VTT Sink/Source Load Transient

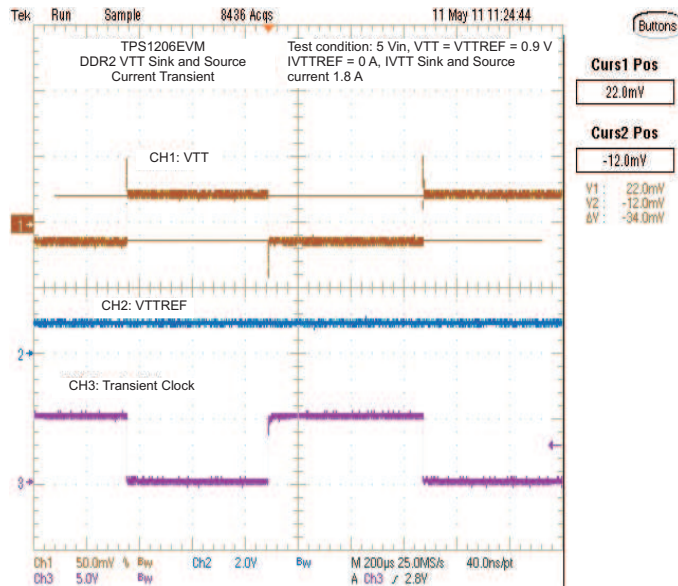

Figure 16. DDR2 (0.9VTT) 1.8-A Sink/Source

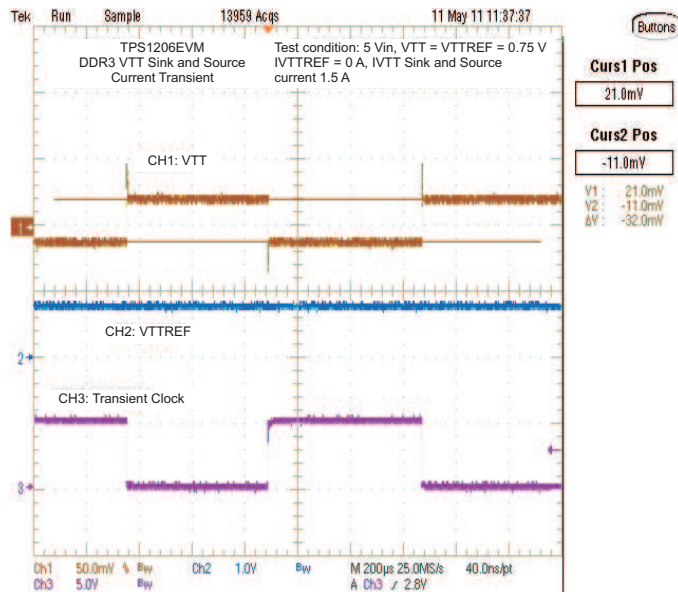

Figure 17. DDR3 (0.75VTT) 1.5-A Sink/Source

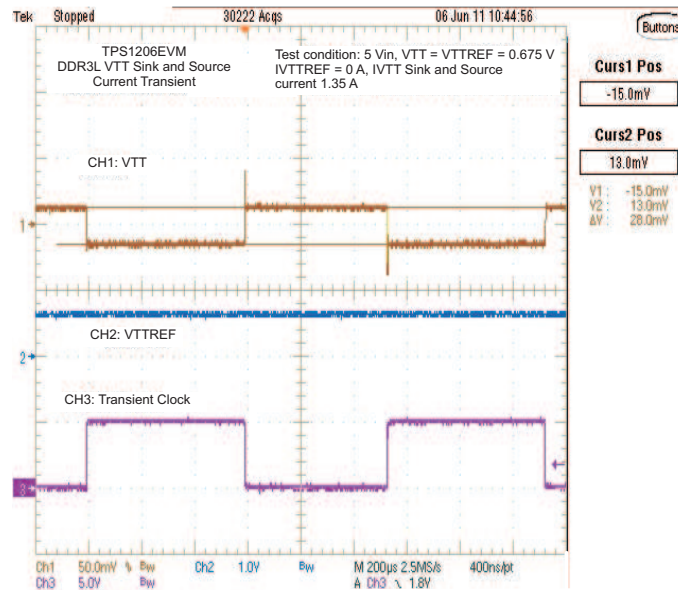

Figure 18. DDR3L (0.75VTT) 1.35-A Sink/Source

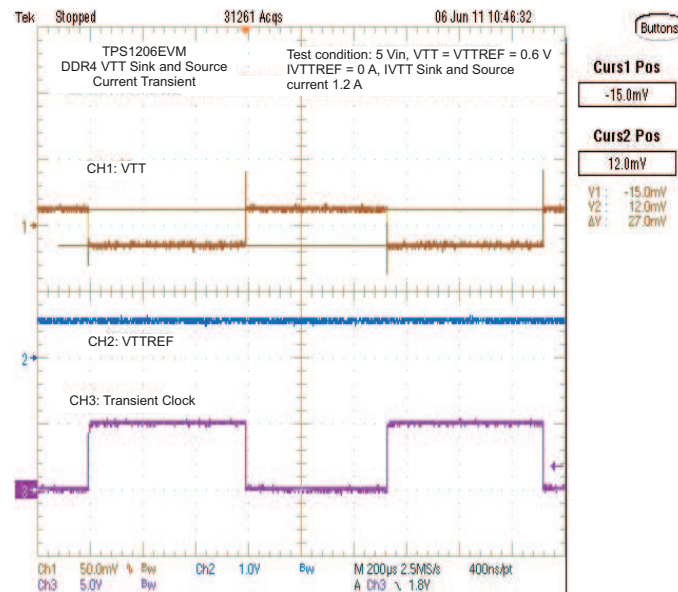

Figure 19. DDR4 (0.6VTT) 1.2-A Sink/Source

7.5 DDR3(0.75VTT) S5 Enable Turnon/Turnoff

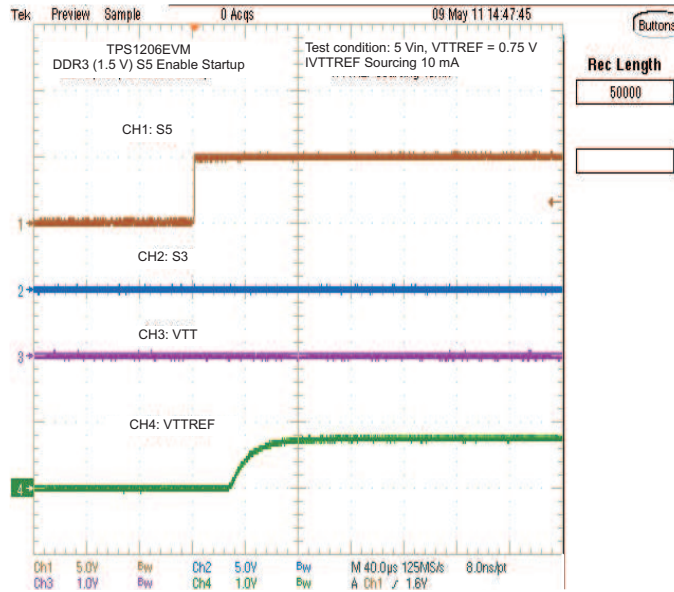

Figure 20. DDR3 (0.75VTT) S5 Enable Turnon

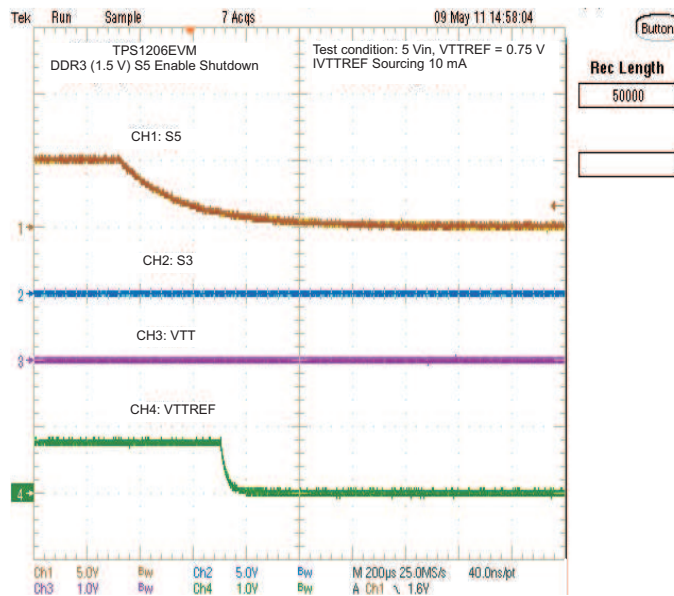

Figure 21. DDR3 (0.75VTT) S5 Enable Turnoff

7.6 DDR3 (0.75VTT) S3 Enable Turnon/Turnoff

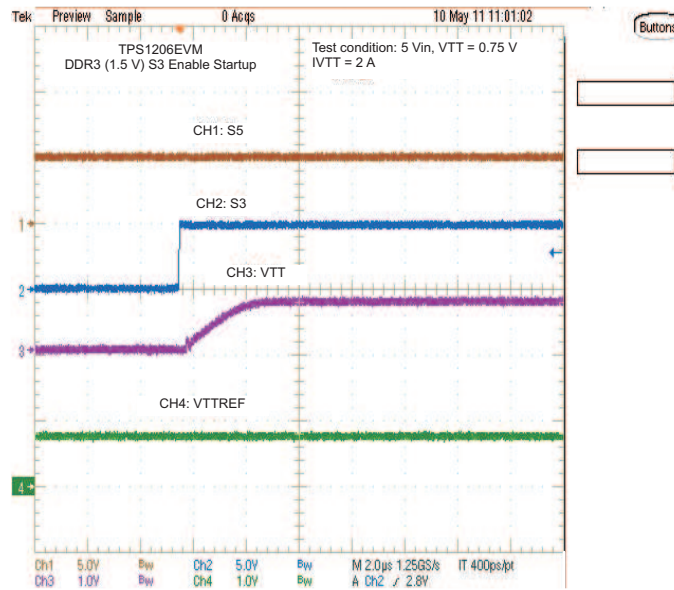

Figure 22. DDR3 (0.75VTT) S3 Enable Turnon

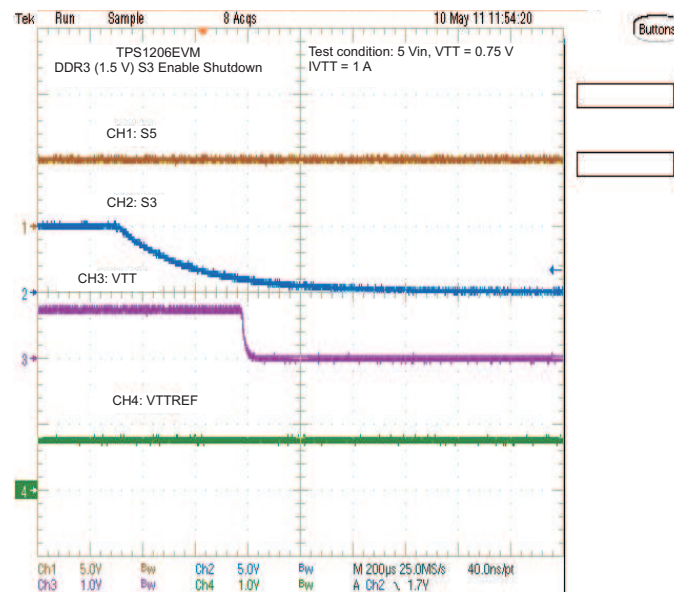
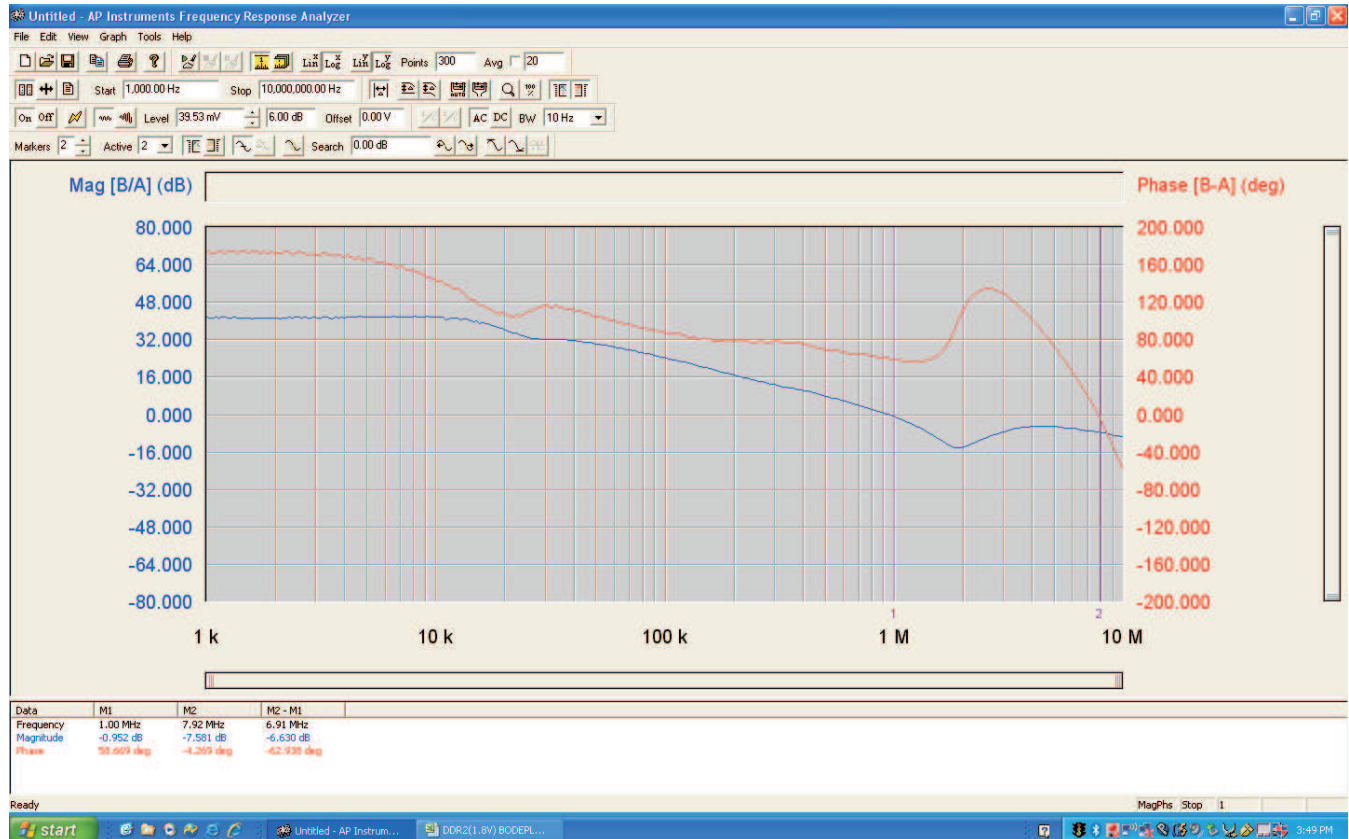

Figure 23. DDR3 (0.75VTT) S3 Enable Turnoff

7.7 DDR3 (0.75VTT) Bode Plot



Test condition: 5 Vin, VLDOIN = VDDQ = 1.5 V, VTT = VTTREF = 0.75 V, I_{VTT} = 2 A Source Current
Phase Margin: 58.7Deg, **Gain Margin:** 7.6dB, **Crossover Frequency:** 1MHz

Figure 24. DDR3 Bode plot

8 EVM Assembly Drawing and PCB Layout

Figure 25 through Figure 30 show the design of the TPS51206EVM-745 printed-circuit board. The EVM has been designed using a four-layer, 2-oz copper, printed-circuit board.

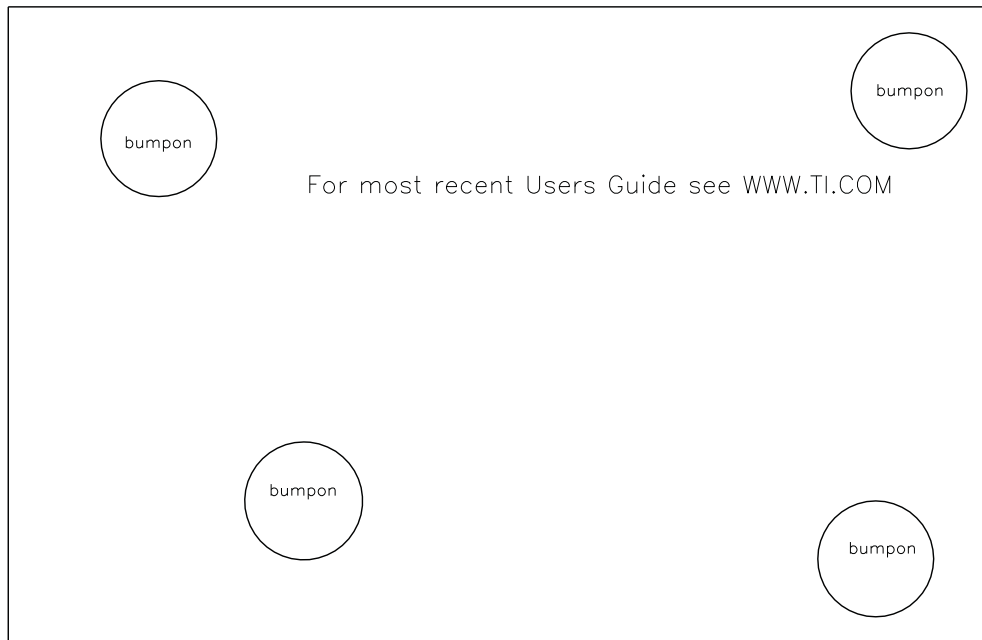

Figure 25. TPS51206EVM-745 Top Layer Assembly Drawing

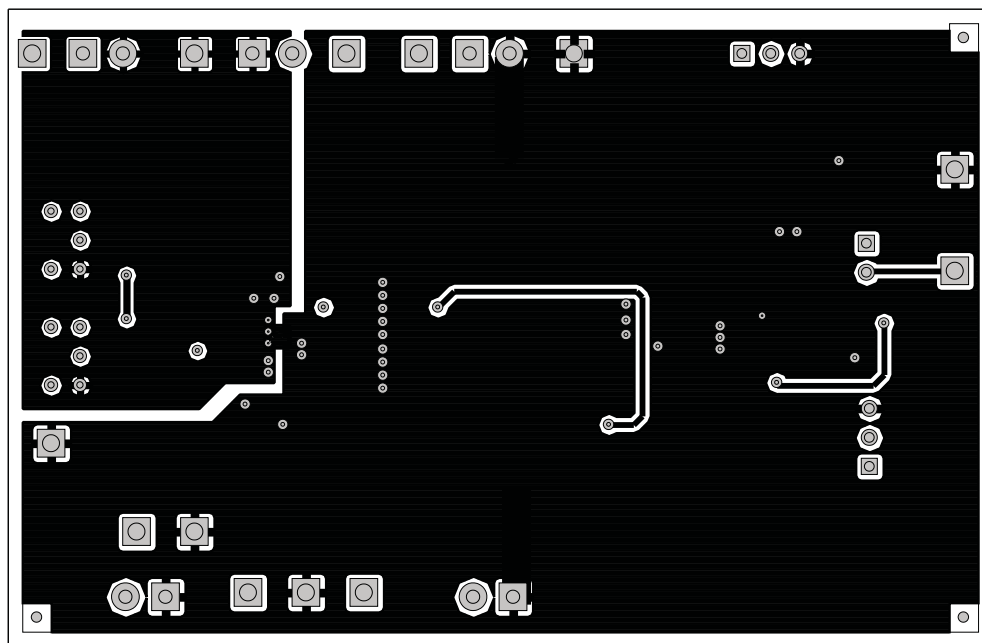

Figure 26. TPS51206EVM-745 Top Layer

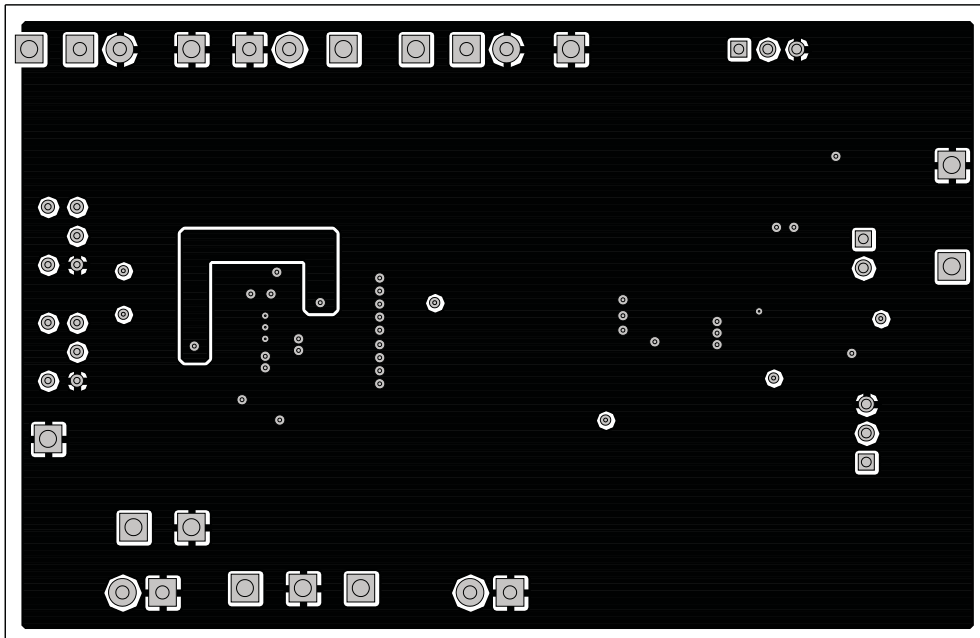

Figure 27. TPS51206EVM-745 Internal Layer 1

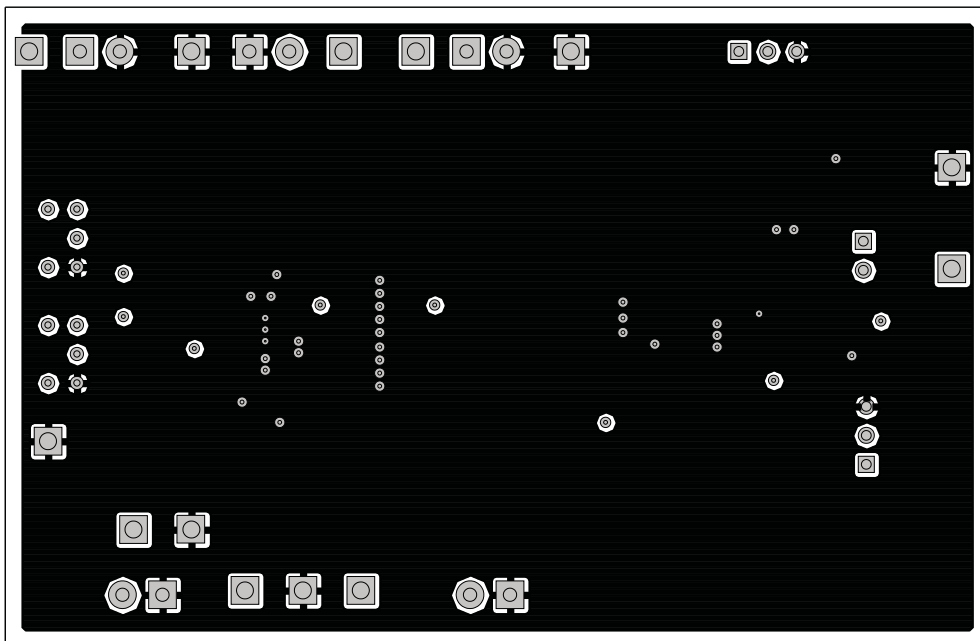

Figure 28. TPS51206EVM-745 Internal Layer 2

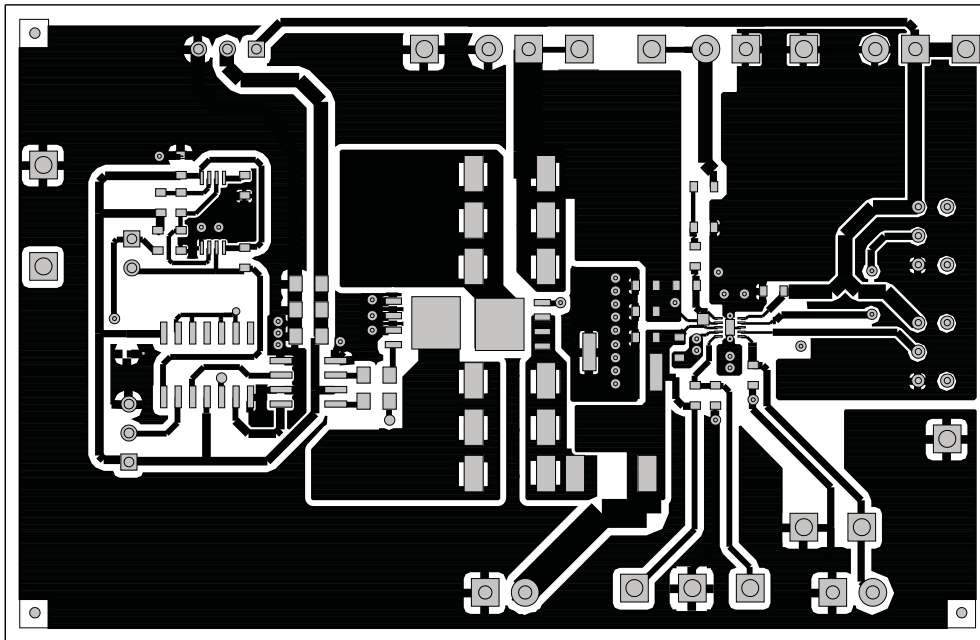

Figure 29. TPS51206EVM-745 Bottom Layer

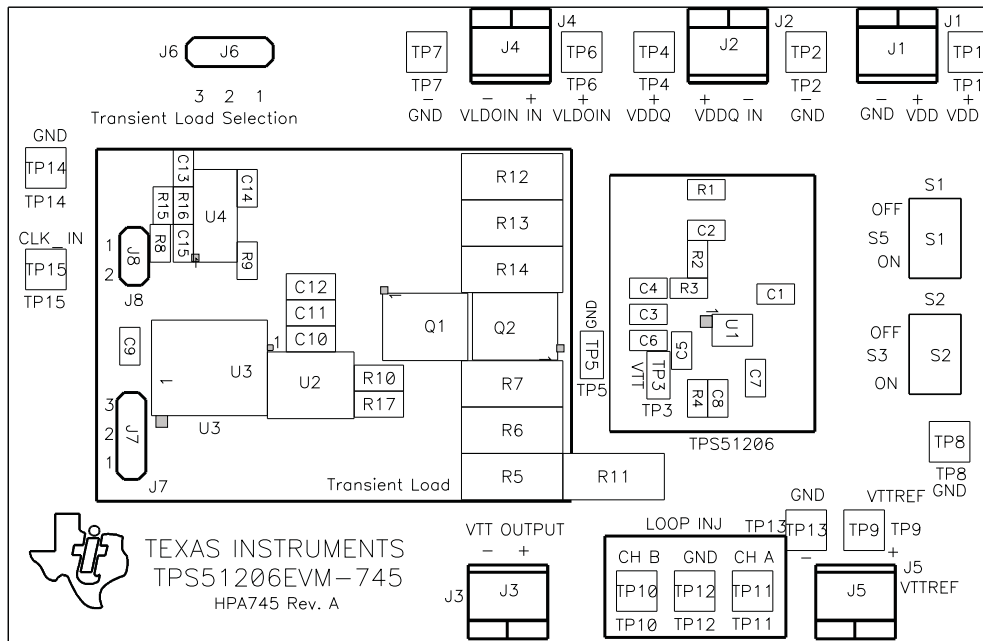

Figure 30. TPS51206EVM-745 Bottom Layer Assembly

9 Bill of Materials

Table 7 provides the EVM components list according to the schematics shown in Figure 1 and Figure 2.

Table 7. Bill of Materials

QTY	RefDes	Description	MFR	Part Number
3	C1, C14, C15	Capacitor, Ceramic, 0.1 μ F, 10V, X7R, 20%, 0603	STD	STD
3	C10, C11, C12	Capacitor, Ceramic, 10 μ F, 10V, X5R, 20%, 0805	STD	STD
3	C3, C4, C5	Capacitor, Ceramic, 10 μ F, 10V, X5R, 20%, 0603	STD	STD
1	C7	Capacitor, Ceramic, 0.22 μ F, 10V, X7R, 20%, 0603	STD	STD
2	C9, C13	Capacitor, Ceramic, 1 μ F, 10V, X7R, 20%, 0603	STD	STD
2	Q1, Q2	MOSFET, Nch, 25V, 31A, 2.5m Ω	TI	CSD16407Q5
2	R10, R17	Resistor, Chip, 100, 1/10W, 5%, 0805	STD	STD
1	R11	Resistor, Chip, 0, 1W, 5%, 2512	STD	STD
1	R15	Resistor, Chip, 1.00k, 1/16W, 1%, 0603	STD	STD
1	R16	Resistor, Chip, 7.50k, 1/16W, 1%, 0603	STD	STD
1	R3	Resistor, Chip, 0, 1/16W, 5%, 0603	STD	STD
1	R4	Resistor, Chip, 10, 1/16W, 5%, 0603	STD	STD
6	R5, R6, R7, R12, R13, R14	Resistor, Chip, 1.5, 1W, 5%, 2512	STD	STD
2	R8, R9	Resistor, Chip, 100k, 1/16W, 1%, 0603	STD	STD
1	U1	IC, 2A Peak sink/source DDR termination regulator	TI	TPS51206DSQ
1	U2	IC, Dual, 4A high speed low side power MOSFET drivers	TI	UCC27325D
1	U3	IC, Quad, 2-Input Positive NAND Gates	TI	SN74AHCT00D
1	U4	IC, Precision Timer	TI	NE555PW

Evaluation Board/Kit Important Notice

Texas Instruments (TI) provides the enclosed product(s) under the following conditions:

This evaluation board/kit is intended for use for **ENGINEERING DEVELOPMENT, DEMONSTRATION, OR EVALUATION PURPOSES ONLY** and is not considered by TI to be a finished end-product fit for general consumer use. Persons handling the product(s) must have electronics training and observe good engineering practice standards. As such, the goods being provided are not intended to be complete in terms of required design-, marketing-, and/or manufacturing-related protective considerations, including product safety and environmental measures typically found in end products that incorporate such semiconductor components or circuit boards. This evaluation board/kit does not fall within the scope of the European Union directives regarding electromagnetic compatibility, restricted substances (RoHS), recycling (WEEE), FCC, CE or UL, and therefore may not meet the technical requirements of these directives or other related directives.

Should this evaluation board/kit not meet the specifications indicated in the User's Guide, the board/kit may be returned within 30 days from the date of delivery for a full refund. **THE FOREGOING WARRANTY IS THE EXCLUSIVE WARRANTY MADE BY SELLER TO BUYER AND IS IN LIEU OF ALL OTHER WARRANTIES, EXPRESSED, IMPLIED, OR STATUTORY, INCLUDING ANY WARRANTY OF MERCHANTABILITY OR FITNESS FOR ANY PARTICULAR PURPOSE.**

The user assumes all responsibility and liability for proper and safe handling of the goods. Further, the user indemnifies TI from all claims arising from the handling or use of the goods. Due to the open construction of the product, it is the user's responsibility to take any and all appropriate precautions with regard to electrostatic discharge.

EXCEPT TO THE EXTENT OF THE INDEMNITY SET FORTH ABOVE, NEITHER PARTY SHALL BE LIABLE TO THE OTHER FOR ANY INDIRECT, SPECIAL, INCIDENTAL, OR CONSEQUENTIAL DAMAGES.

TI currently deals with a variety of customers for products, and therefore our arrangement with the user **is not exclusive.**

TI assumes **no liability for applications assistance, customer product design, software performance, or infringement of patents or services described herein.**

Please read the User's Guide and, specifically, the Warnings and Restrictions notice in the User's Guide prior to handling the product. This notice contains important safety information about temperatures and voltages. For additional information on TI's environmental and/or safety programs, please contact the TI application engineer or visit www.ti.com/esh.

No license is granted under any patent right or other intellectual property right of TI covering or relating to any machine, process, or combination in which such TI products or services might be or are used.

FCC Warning

This evaluation board/kit is intended for use for **ENGINEERING DEVELOPMENT, DEMONSTRATION, OR EVALUATION PURPOSES ONLY** and is not considered by TI to be a finished end-product fit for general consumer use. It generates, uses, and can radiate radio frequency energy and has not been tested for compliance with the limits of computing devices pursuant to part 15 of FCC rules, which are designed to provide reasonable protection against radio frequency interference. Operation of this equipment in other environments may cause interference with radio communications, in which case the user at his own expense will be required to take whatever measures may be required to correct this interference.

EVM Warnings and Restrictions

It is important to operate this EVM within the input voltage range of 0 V to 5.5 V and the output voltage range of 0.6 V to 1.8 V .

Exceeding the specified input range may cause unexpected operation and/or irreversible damage to the EVM. If there are questions concerning the input range, please contact a TI field representative prior to connecting the input power.

Applying loads outside of the specified output range may result in unintended operation and/or possible permanent damage to the EVM. Please consult the EVM User's Guide prior to connecting any load to the EVM output. If there is uncertainty as to the load specification, please contact a TI field representative.

During normal operation, some circuit components may have case temperatures greater than 50°C. The EVM is designed to operate properly with certain components above 50°C as long as the input and output ranges are maintained. These components include but are not limited to linear regulators, switching transistors, pass transistors, and current sense resistors. These types of devices can be identified using the EVM schematic located in the EVM User's Guide. When placing measurement probes near these devices during operation, please be aware that these devices may be very warm to the touch.

Mailing Address: Texas Instruments, Post Office Box 655303, Dallas, Texas 75265
Copyright © 2011, Texas Instruments Incorporated

STANDARD TERMS FOR EVALUATION MODULES

1. *Delivery:* TI delivers TI evaluation boards, kits, or modules, including any accompanying demonstration software, components, and/or documentation which may be provided together or separately (collectively, an "EVM" or "EVMs") to the User ("User") in accordance with the terms set forth herein. User's acceptance of the EVM is expressly subject to the following terms.
 - 1.1 EVMs are intended solely for product or software developers for use in a research and development setting to facilitate feasibility evaluation, experimentation, or scientific analysis of TI semiconductors products. EVMs have no direct function and are not finished products. EVMs shall not be directly or indirectly assembled as a part or subassembly in any finished product. For clarification, any software or software tools provided with the EVM ("Software") shall not be subject to the terms and conditions set forth herein but rather shall be subject to the applicable terms that accompany such Software
 - 1.2 EVMs are not intended for consumer or household use. EVMs may not be sold, sublicensed, leased, rented, loaned, assigned, or otherwise distributed for commercial purposes by Users, in whole or in part, or used in any finished product or production system.
2. *Limited Warranty and Related Remedies/Disclaimers:*
 - 2.1 These terms do not apply to Software. The warranty, if any, for Software is covered in the applicable Software License Agreement.
 - 2.2 TI warrants that the TI EVM will conform to TI's published specifications for ninety (90) days after the date TI delivers such EVM to User. Notwithstanding the foregoing, TI shall not be liable for a nonconforming EVM if (a) the nonconformity was caused by neglect, misuse or mistreatment by an entity other than TI, including improper installation or testing, or for any EVMs that have been altered or modified in any way by an entity other than TI, (b) the nonconformity resulted from User's design, specifications or instructions for such EVMs or improper system design, or (c) User has not paid on time. Testing and other quality control techniques are used to the extent TI deems necessary. TI does not test all parameters of each EVM. User's claims against TI under this Section 2 are void if User fails to notify TI of any apparent defects in the EVMs within ten (10) business days after delivery, or of any hidden defects with ten (10) business days after the defect has been detected.
 - 2.3 TI's sole liability shall be at its option to repair or replace EVMs that fail to conform to the warranty set forth above, or credit User's account for such EVM. TI's liability under this warranty shall be limited to EVMs that are returned during the warranty period to the address designated by TI and that are determined by TI not to conform to such warranty. If TI elects to repair or replace such EVM, TI shall have a reasonable time to repair such EVM or provide replacements. Repaired EVMs shall be warranted for the remainder of the original warranty period. Replaced EVMs shall be warranted for a new full ninety (90) day warranty period.

WARNING

Evaluation Kits are intended solely for use by technically qualified, professional electronics experts who are familiar with the dangers and application risks associated with handling electrical mechanical components, systems, and subsystems.

User shall operate the Evaluation Kit within TI's recommended guidelines and any applicable legal or environmental requirements as well as reasonable and customary safeguards. Failure to set up and/or operate the Evaluation Kit within TI's recommended guidelines may result in personal injury or death or property damage. Proper set up entails following TI's instructions for electrical ratings of interface circuits such as input, output and electrical loads.

NOTE:

EXPOSURE TO ELECTROSTATIC DISCHARGE (ESD) MAY CAUSE DEGRADATION OR FAILURE OF THE EVALUATION KIT; TI RECOMMENDS STORAGE OF THE EVALUATION KIT IN A PROTECTIVE ESD BAG.

3 Regulatory Notices:

3.1 United States

3.1.1 Notice applicable to EVMs not FCC-Approved:

FCC NOTICE: This kit is designed to allow product developers to evaluate electronic components, circuitry, or software associated with the kit to determine whether to incorporate such items in a finished product and software developers to write software applications for use with the end product. This kit is not a finished product and when assembled may not be resold or otherwise marketed unless all required FCC equipment authorizations are first obtained. Operation is subject to the condition that this product not cause harmful interference to licensed radio stations and that this product accept harmful interference. Unless the assembled kit is designed to operate under part 15, part 18 or part 95 of this chapter, the operator of the kit must operate under the authority of an FCC license holder or must secure an experimental authorization under part 5 of this chapter.

3.1.2 For EVMs annotated as FCC – FEDERAL COMMUNICATIONS COMMISSION Part 15 Compliant:

CAUTION

This device complies with part 15 of the FCC Rules. Operation is subject to the following two conditions: (1) This device may not cause harmful interference, and (2) this device must accept any interference received, including interference that may cause undesired operation.

Changes or modifications not expressly approved by the party responsible for compliance could void the user's authority to operate the equipment.

FCC Interference Statement for Class A EVM devices

NOTE: This equipment has been tested and found to comply with the limits for a Class A digital device, pursuant to part 15 of the FCC Rules. These limits are designed to provide reasonable protection against harmful interference when the equipment is operated in a commercial environment. This equipment generates, uses, and can radiate radio frequency energy and, if not installed and used in accordance with the instruction manual, may cause harmful interference to radio communications. Operation of this equipment in a residential area is likely to cause harmful interference in which case the user will be required to correct the interference at his own expense.

FCC Interference Statement for Class B EVM devices

NOTE: This equipment has been tested and found to comply with the limits for a Class B digital device, pursuant to part 15 of the FCC Rules. These limits are designed to provide reasonable protection against harmful interference in a residential installation. This equipment generates, uses and can radiate radio frequency energy and, if not installed and used in accordance with the instructions, may cause harmful interference to radio communications. However, there is no guarantee that interference will not occur in a particular installation. If this equipment does cause harmful interference to radio or television reception, which can be determined by turning the equipment off and on, the user is encouraged to try to correct the interference by one or more of the following measures:

- Reorient or relocate the receiving antenna.
- Increase the separation between the equipment and receiver.
- Connect the equipment into an outlet on a circuit different from that to which the receiver is connected.
- Consult the dealer or an experienced radio/TV technician for help.

3.2 Canada

3.2.1 For EVMs issued with an Industry Canada Certificate of Conformance to RSS-210 or RSS-247

Concerning EVMs Including Radio Transmitters:

This device complies with Industry Canada license-exempt RSSs. Operation is subject to the following two conditions:

(1) this device may not cause interference, and (2) this device must accept any interference, including interference that may cause undesired operation of the device.

Concernant les EVMs avec appareils radio:

Le présent appareil est conforme aux CNR d'Industrie Canada applicables aux appareils radio exempts de licence. L'exploitation est autorisée aux deux conditions suivantes: (1) l'appareil ne doit pas produire de brouillage, et (2) l'utilisateur de l'appareil doit accepter tout brouillage radioélectrique subi, même si le brouillage est susceptible d'en compromettre le fonctionnement.

Concerning EVMs Including Detachable Antennas:

Under Industry Canada regulations, this radio transmitter may only operate using an antenna of a type and maximum (or lesser) gain approved for the transmitter by Industry Canada. To reduce potential radio interference to other users, the antenna type and its gain should be so chosen that the equivalent isotropically radiated power (e.i.r.p.) is not more than that necessary for successful communication. This radio transmitter has been approved by Industry Canada to operate with the antenna types listed in the user guide with the maximum permissible gain and required antenna impedance for each antenna type indicated. Antenna types not included in this list, having a gain greater than the maximum gain indicated for that type, are strictly prohibited for use with this device.

Concernant les EVMs avec antennes détachables

Conformément à la réglementation d'Industrie Canada, le présent émetteur radio peut fonctionner avec une antenne d'un type et d'un gain maximal (ou inférieur) approuvé pour l'émetteur par Industrie Canada. Dans le but de réduire les risques de brouillage radioélectrique à l'intention des autres utilisateurs, il faut choisir le type d'antenne et son gain de sorte que la puissance isotrope rayonnée équivalente (p.i.r.e.) ne dépasse pas l'intensité nécessaire à l'établissement d'une communication satisfaisante. Le présent émetteur radio a été approuvé par Industrie Canada pour fonctionner avec les types d'antenne énumérés dans le manuel d'usage et ayant un gain admissible maximal et l'impédance requise pour chaque type d'antenne. Les types d'antenne non inclus dans cette liste, ou dont le gain est supérieur au gain maximal indiqué, sont strictement interdits pour l'exploitation de l'émetteur.

3.3 Japan

3.3.1 *Notice for EVMs delivered in Japan:* Please see http://www.tij.co.jp/lstds/ti_ja/general/eStore/notice_01.page 日本国内に輸入される評価用キット、ボードについては、次のところをご覧ください。

<https://www.ti.com/ja-jp/legal/notice-for-evaluation-kits-delivered-in-japan.html>

3.3.2 *Notice for Users of EVMs Considered "Radio Frequency Products" in Japan:* EVMs entering Japan may not be certified by TI as conforming to Technical Regulations of Radio Law of Japan.

If User uses EVMs in Japan, not certified to Technical Regulations of Radio Law of Japan, User is required to follow the instructions set forth by Radio Law of Japan, which includes, but is not limited to, the instructions below with respect to EVMs (which for the avoidance of doubt are stated strictly for convenience and should be verified by User):

1. Use EVMs in a shielded room or any other test facility as defined in the notification #173 issued by Ministry of Internal Affairs and Communications on March 28, 2006, based on Sub-section 1.1 of Article 6 of the Ministry's Rule for Enforcement of Radio Law of Japan,
2. Use EVMs only after User obtains the license of Test Radio Station as provided in Radio Law of Japan with respect to EVMs, or
3. Use of EVMs only after User obtains the Technical Regulations Conformity Certification as provided in Radio Law of Japan with respect to EVMs. Also, do not transfer EVMs, unless User gives the same notice above to the transferee. Please note that if User does not follow the instructions above, User will be subject to penalties of Radio Law of Japan.

【無線電波を送信する製品の開発キットをお使いになる際の注意事項】 開発キットの中には技術基準適合証明を受けていないものがあります。技術適合証明を受けていないものご使用に際しては、電波法遵守のため、以下のいずれかの措置を取っていただく必要がありますのでご注意ください。

1. 電波法施行規則第6条第1項第1号に基づく平成18年3月28日総務省告示第173号で定められた電波暗室等の試験設備でご使用いただく。
2. 実験局の免許を取得後ご使用いただく。
3. 技術基準適合証明を取得後ご使用いただく。

なお、本製品は、上記の「ご使用にあたっての注意」を譲渡先、移転先に通知しない限り、譲渡、移転できないものとします。

上記を遵守頂けない場合は、電波法の罰則が適用される可能性があることをご留意ください。日本テキサス・イ

ンスツルメンツ株式会社

東京都新宿区西新宿 6 丁目 2 4 番 1 号

西新宿三井ビル

3.3.3 *Notice for EVMs for Power Line Communication:* Please see http://www.tij.co.jp/lstds/ti_ja/general/eStore/notice_02.page

電力線搬送波通信についての開発キットをお使いになる際の注意事項については、次のところをご覧ください。 <https://www.ti.com/ja-jp/legal/notice-for-evaluation-kits-for-power-line-communication.html>

3.4 European Union

3.4.1 *For EVMs subject to EU Directive 2014/30/EU (Electromagnetic Compatibility Directive):*

This is a class A product intended for use in environments other than domestic environments that are connected to a low-voltage power-supply network that supplies buildings used for domestic purposes. In a domestic environment this product may cause radio interference in which case the user may be required to take adequate measures.

-
- 4 *EVM Use Restrictions and Warnings:*
 - 4.1 EVMS ARE NOT FOR USE IN FUNCTIONAL SAFETY AND/OR SAFETY CRITICAL EVALUATIONS, INCLUDING BUT NOT LIMITED TO EVALUATIONS OF LIFE SUPPORT APPLICATIONS.
 - 4.2 User must read and apply the user guide and other available documentation provided by TI regarding the EVM prior to handling or using the EVM, including without limitation any warning or restriction notices. The notices contain important safety information related to, for example, temperatures and voltages.
 - 4.3 *Safety-Related Warnings and Restrictions:*
 - 4.3.1 User shall operate the EVM within TI's recommended specifications and environmental considerations stated in the user guide, other available documentation provided by TI, and any other applicable requirements and employ reasonable and customary safeguards. Exceeding the specified performance ratings and specifications (including but not limited to input and output voltage, current, power, and environmental ranges) for the EVM may cause personal injury or death, or property damage. If there are questions concerning performance ratings and specifications, User should contact a TI field representative prior to connecting interface electronics including input power and intended loads. Any loads applied outside of the specified output range may also result in unintended and/or inaccurate operation and/or possible permanent damage to the EVM and/or interface electronics. Please consult the EVM user guide prior to connecting any load to the EVM output. If there is uncertainty as to the load specification, please contact a TI field representative. During normal operation, even with the inputs and outputs kept within the specified allowable ranges, some circuit components may have elevated case temperatures. These components include but are not limited to linear regulators, switching transistors, pass transistors, current sense resistors, and heat sinks, which can be identified using the information in the associated documentation. When working with the EVM, please be aware that the EVM may become very warm.
 - 4.3.2 EVMs are intended solely for use by technically qualified, professional electronics experts who are familiar with the dangers and application risks associated with handling electrical mechanical components, systems, and subsystems. User assumes all responsibility and liability for proper and safe handling and use of the EVM by User or its employees, affiliates, contractors or designees. User assumes all responsibility and liability to ensure that any interfaces (electronic and/or mechanical) between the EVM and any human body are designed with suitable isolation and means to safely limit accessible leakage currents to minimize the risk of electrical shock hazard. User assumes all responsibility and liability for any improper or unsafe handling or use of the EVM by User or its employees, affiliates, contractors or designees.
 - 4.4 User assumes all responsibility and liability to determine whether the EVM is subject to any applicable international, federal, state, or local laws and regulations related to User's handling and use of the EVM and, if applicable, User assumes all responsibility and liability for compliance in all respects with such laws and regulations. User assumes all responsibility and liability for proper disposal and recycling of the EVM consistent with all applicable international, federal, state, and local requirements.
 5. *Accuracy of Information:* To the extent TI provides information on the availability and function of EVMs, TI attempts to be as accurate as possible. However, TI does not warrant the accuracy of EVM descriptions, EVM availability or other information on its websites as accurate, complete, reliable, current, or error-free.
 6. *Disclaimers:*
 - 6.1 EXCEPT AS SET FORTH ABOVE, EVMS AND ANY MATERIALS PROVIDED WITH THE EVM (INCLUDING, BUT NOT LIMITED TO, REFERENCE DESIGNS AND THE DESIGN OF THE EVM ITSELF) ARE PROVIDED "AS IS" AND "WITH ALL FAULTS." TI DISCLAIMS ALL OTHER WARRANTIES, EXPRESS OR IMPLIED, REGARDING SUCH ITEMS, INCLUDING BUT NOT LIMITED TO ANY EPIDEMIC FAILURE WARRANTY OR IMPLIED WARRANTIES OF MERCHANTABILITY OR FITNESS FOR A PARTICULAR PURPOSE OR NON-INFRINGEMENT OF ANY THIRD PARTY PATENTS, COPYRIGHTS, TRADE SECRETS OR OTHER INTELLECTUAL PROPERTY RIGHTS.
 - 6.2 EXCEPT FOR THE LIMITED RIGHT TO USE THE EVM SET FORTH HEREIN, NOTHING IN THESE TERMS SHALL BE CONSTRUED AS GRANTING OR CONFERRING ANY RIGHTS BY LICENSE, PATENT, OR ANY OTHER INDUSTRIAL OR INTELLECTUAL PROPERTY RIGHT OF TI, ITS SUPPLIERS/LICENSORS OR ANY OTHER THIRD PARTY, TO USE THE EVM IN ANY FINISHED END-USER OR READY-TO-USE FINAL PRODUCT, OR FOR ANY INVENTION, DISCOVERY OR IMPROVEMENT, REGARDLESS OF WHEN MADE, CONCEIVED OR ACQUIRED.
 7. *USER'S INDEMNITY OBLIGATIONS AND REPRESENTATIONS.* USER WILL DEFEND, INDEMNIFY AND HOLD TI, ITS LICENSORS AND THEIR REPRESENTATIVES HARMLESS FROM AND AGAINST ANY AND ALL CLAIMS, DAMAGES, LOSSES, EXPENSES, COSTS AND LIABILITIES (COLLECTIVELY, "CLAIMS") ARISING OUT OF OR IN CONNECTION WITH ANY HANDLING OR USE OF THE EVM THAT IS NOT IN ACCORDANCE WITH THESE TERMS. THIS OBLIGATION SHALL APPLY WHETHER CLAIMS ARISE UNDER STATUTE, REGULATION, OR THE LAW OF TORT, CONTRACT OR ANY OTHER LEGAL THEORY, AND EVEN IF THE EVM FAILS TO PERFORM AS DESCRIBED OR EXPECTED.
-

8. *Limitations on Damages and Liability:*

8.1 *General Limitations.* IN NO EVENT SHALL TI BE LIABLE FOR ANY SPECIAL, COLLATERAL, INDIRECT, PUNITIVE, INCIDENTAL, CONSEQUENTIAL, OR EXEMPLARY DAMAGES IN CONNECTION WITH OR ARISING OUT OF THESE TERMS OR THE USE OF THE EVMS , REGARDLESS OF WHETHER TI HAS BEEN ADVISED OF THE POSSIBILITY OF SUCH DAMAGES. EXCLUDED DAMAGES INCLUDE, BUT ARE NOT LIMITED TO, COST OF REMOVAL OR REINSTALLATION, ANCILLARY COSTS TO THE PROCUREMENT OF SUBSTITUTE GOODS OR SERVICES, RETESTING, OUTSIDE COMPUTER TIME, LABOR COSTS, LOSS OF GOODWILL, LOSS OF PROFITS, LOSS OF SAVINGS, LOSS OF USE, LOSS OF DATA, OR BUSINESS INTERRUPTION. NO CLAIM, SUIT OR ACTION SHALL BE BROUGHT AGAINST TI MORE THAN TWELVE (12) MONTHS AFTER THE EVENT THAT GAVE RISE TO THE CAUSE OF ACTION HAS OCCURRED.

8.2 *Specific Limitations.* IN NO EVENT SHALL TI'S AGGREGATE LIABILITY FROM ANY USE OF AN EVM PROVIDED HEREUNDER, INCLUDING FROM ANY WARRANTY, INDEMNITY OR OTHER OBLIGATION ARISING OUT OF OR IN CONNECTION WITH THESE TERMS, , EXCEED THE TOTAL AMOUNT PAID TO TI BY USER FOR THE PARTICULAR EVM(S) AT ISSUE DURING THE PRIOR TWELVE (12) MONTHS WITH RESPECT TO WHICH LOSSES OR DAMAGES ARE CLAIMED. THE EXISTENCE OF MORE THAN ONE CLAIM SHALL NOT ENLARGE OR EXTEND THIS LIMIT.

9. *Return Policy.* Except as otherwise provided, TI does not offer any refunds, returns, or exchanges. Furthermore, no return of EVM(s) will be accepted if the package has been opened and no return of the EVM(s) will be accepted if they are damaged or otherwise not in a resalable condition. If User feels it has been incorrectly charged for the EVM(s) it ordered or that delivery violates the applicable order, User should contact TI. All refunds will be made in full within thirty (30) working days from the return of the components(s), excluding any postage or packaging costs.

10. *Governing Law:* These terms and conditions shall be governed by and interpreted in accordance with the laws of the State of Texas, without reference to conflict-of-laws principles. User agrees that non-exclusive jurisdiction for any dispute arising out of or relating to these terms and conditions lies within courts located in the State of Texas and consents to venue in Dallas County, Texas. Notwithstanding the foregoing, any judgment may be enforced in any United States or foreign court, and TI may seek injunctive relief in any United States or foreign court.

Mailing Address: Texas Instruments, Post Office Box 655303, Dallas, Texas 75265
Copyright © 2023, Texas Instruments Incorporated

IMPORTANT NOTICE AND DISCLAIMER

TI PROVIDES TECHNICAL AND RELIABILITY DATA (INCLUDING DATASHEETS), DESIGN RESOURCES (INCLUDING REFERENCE DESIGNS), APPLICATION OR OTHER DESIGN ADVICE, WEB TOOLS, SAFETY INFORMATION, AND OTHER RESOURCES "AS IS" AND WITH ALL FAULTS, AND DISCLAIMS ALL WARRANTIES, EXPRESS AND IMPLIED, INCLUDING WITHOUT LIMITATION ANY IMPLIED WARRANTIES OF MERCHANTABILITY, FITNESS FOR A PARTICULAR PURPOSE OR NON-INFRINGEMENT OF THIRD PARTY INTELLECTUAL PROPERTY RIGHTS.

These resources are intended for skilled developers designing with TI products. You are solely responsible for (1) selecting the appropriate TI products for your application, (2) designing, validating and testing your application, and (3) ensuring your application meets applicable standards, and any other safety, security, regulatory or other requirements.

These resources are subject to change without notice. TI grants you permission to use these resources only for development of an application that uses the TI products described in the resource. Other reproduction and display of these resources is prohibited. No license is granted to any other TI intellectual property right or to any third party intellectual property right. TI disclaims responsibility for, and you fully indemnify TI and its representatives against any claims, damages, costs, losses, and liabilities arising out of your use of these resources.

TI's products are provided subject to [TI's Terms of Sale](#), [TI's General Quality Guidelines](#), or other applicable terms available either on ti.com or provided in conjunction with such TI products. TI's provision of these resources does not expand or otherwise alter TI's applicable warranties or warranty disclaimers for TI products. Unless TI explicitly designates a product as custom or customer-specified, TI products are standard, catalog, general purpose devices.

TI objects to and rejects any additional or different terms you may propose.

Copyright © 2026, Texas Instruments Incorporated

Last updated 10/2025