

TPS53219 Buck Controller Evaluation Module User's Guide



ABSTRACT

The TPS53219EVM-690 evaluation module allows users to evaluate the Texas Instruments TPS53219, a small-sized, single, buck controller with adaptive on-time D-CAP™ mode control. Included in this document are operating and testing descriptions as well as the EVM schematic, bill of materials, and board layout.

Table of Contents

1 Introduction	3
Description	4
2.1 Typical Applications.....	4
2.2 Features.....	4
2 Electrical Performance Specifications	5
3 Schematic	6
4 Test Setup	7
4.1 Test Equipment.....	7
4.2 Recommended Test Setup.....	8
5 Configurations	9
5.1 Switching Frequency Selection.....	9
5.2 Soft-Start Selection.....	9
5.3 Mode Selection.....	9
5.4 Enable Selection.....	9
6 Test Procedure	10
6.1 Line/Load Regulation and Efficiency Measurement Procedure.....	10
6.2 Control Loop Gain and Phase Measurement Procedure.....	10
6.3 List of Test Points.....	10
6.4 Equipment Shutdown.....	10
7 Performance Data and Typical Characteristic Curves	11
7.1 Efficiency.....	11
7.2 Load Regulation.....	11
7.3 Output Transient.....	12
7.4 Output Ripple.....	13
7.5 Switching Node.....	13
7.6 Enable Turn-On/Turn-Off.....	14
7.7 Output 1.1-V Prebias Turn-On.....	15
7.8 Bode Plot.....	15
7.9 Thermal Image.....	16
8 EVM Assembly Drawing and PCB Layout	17
9 Bill of Materials	21
10 Revision History	21

List of Figures

Figure 3-1. TPS53219EVM-690 Schematic.....	6
Figure 4-1. Tip and Barrel Measurement for Vout Ripple.....	7
Figure 4-2. TPS53219EVM-690 Recommended Test Setup.....	8
Figure 7-1. Efficiency.....	11
Figure 7-2. Load Regulation.....	11
Figure 7-3. Output Load Transient.....	12
Figure 7-4. Output Load Transient.....	12
Figure 7-5. Output Ripple.....	13

Figure 7-6. Switching Node.....	13
Figure 7-7. Enable Turn-On.....	14
Figure 7-8. Enable Turn-Off.....	14
Figure 7-9. Output 1.1-V Prebias Turn-On.....	15
Figure 7-10. Bode Plot at 12 V _{IN} , 1.1 V/25 A.....	15
Figure 7-11. Top Board at 12 V _{IN} , 1.1 V/25 A.....	16
Figure 7-12. Bottom Board at 12 V _{IN} , 1.1 V/25 A.....	16
Figure 8-1. TPS53219EVM-690 Top Layer Assembly Drawing, Top View.....	17
Figure 8-2. TPS53219EVM-690 Bottom Assembly Drawing, Bottom View.....	17
Figure 8-3. TPS53219EVM-690 Top Copper, Top View.....	18
Figure 8-4. TPS53219EVM-690 Layer-2 Copper, Top View.....	18
Figure 8-5. TPS53219EVM-690 Layer-3 Copper, Top View.....	19
Figure 8-6. TPS53219EVM-690 Layer-4 Copper, Top View.....	19
Figure 8-7. TPS53219EVM-690 Layer-5 Copper, Top View.....	20
Figure 8-8. TPS53219EVM-690 Bottom Layer Copper, Top View.....	20

List of Tables

Table 2-1. TPS53219EVM-690 Electrical Performance Specifications.....	5
Table 5-1. Switching Frequency Selection.....	9
Table 5-2. Soft-Start Selection.....	9
Table 5-3. MODE Selection.....	9
Table 5-4. Enable Selection.....	9
Table 6-1. Functions of Each Test Points.....	10
Table 9-1. The EVM Bill of Materials According to Schematic Shown in Figure 3-1	21

Trademarks

D-CAP™ is a trademark of Texas Instruments.
 All trademarks are the property of their respective owners.

1 Introduction

The TPS53219EVM-690 evaluation module (EVM) uses the TPS53219. The TPS53219 is a small-size, single buck controller with adaptive on-time D-CAP™ mode control. The device provides a fixed 1.1-V output at up to 25 A from a 12-V input bus. The TPS53219EVM-690 also uses the 5-mm × 6-mm TI power block MOSFET (CSD86350Q5D) for high power density and superior thermal performance.

Description

The TPS53219EVM-690 is designed to use a regulated 12-V bus to produce a regulated 1.1-V output at up to 25 A of load current. The TPS53219EVM-690 is designed to demonstrate the TPS53219 in a typical low-voltage application while providing test points to evaluate the performance of the TPS53219.

2.1 Typical Applications

- Point of load systems
- Storage computer
- Server computer
- Multifunction printer
- Embedded computing

2.2 Features

The TPS53219EVM-690 features:

- 25-A_{DC}, steady-state output current
- Support prebias output voltage start-up
- High efficiency and high power density by using TI power block MOSFET
- J1 for selectable switching frequency setting
- J2 for selectable internal voltage servo soft start
- J3 for enable function
- J6 for auto-skip and forced CCM selection
- Convenient test points for probing critical waveforms

2 Electrical Performance Specifications

Table 2-1. TPS53219EVM-690 Electrical Performance Specifications

PARAMETER	TEST CONDITIONS	MIN	TYP	MAX	UNITS
INPUT CHARACTERISTICS					
Voltage range	V_{IN}	8	12	14	V
Maximum input current	$V_{IN} = 8\text{ V}$, $I_O = 25\text{ A}$		4		A
No load input current	$V_{IN} = 14\text{ V}$, $I_O = 0\text{ A}$ with auto-skip mode		1		mA
OUTPUT CHARACTERISTICS					
Output voltage, V_{OUT}			1.1		V
Output voltage regulation	Line regulation ($V_{IN} = 8\text{ V}$ to 14 V)		0.5%		
	Load regulation ($V_{IN} = 12\text{ V}$, $I_O = 0\text{ A}$ to 25 A)		0.5%		
Output voltage ripple	$V_{IN} = 12\text{ V}$, $I_O = 25\text{ A}$		25		mVpp
Output load current		0		25	A
Output over current			35		A
SYSTEMS CHARACTERISTICS					
Switching frequency			300		kHz
Peak efficiency	$V_{IN} = 12\text{ V}$, $1.1\text{ V}/10\text{ A}$		90.90%		
Full-load efficiency	$V_{IN} = 12\text{ V}$, $1.1\text{ V}/25\text{ A}$		88.59%		
Operating temperature			25		°C

Note: Jumpers set to default locations. See [Section 5](#) of this user's guide.

3 Schematic

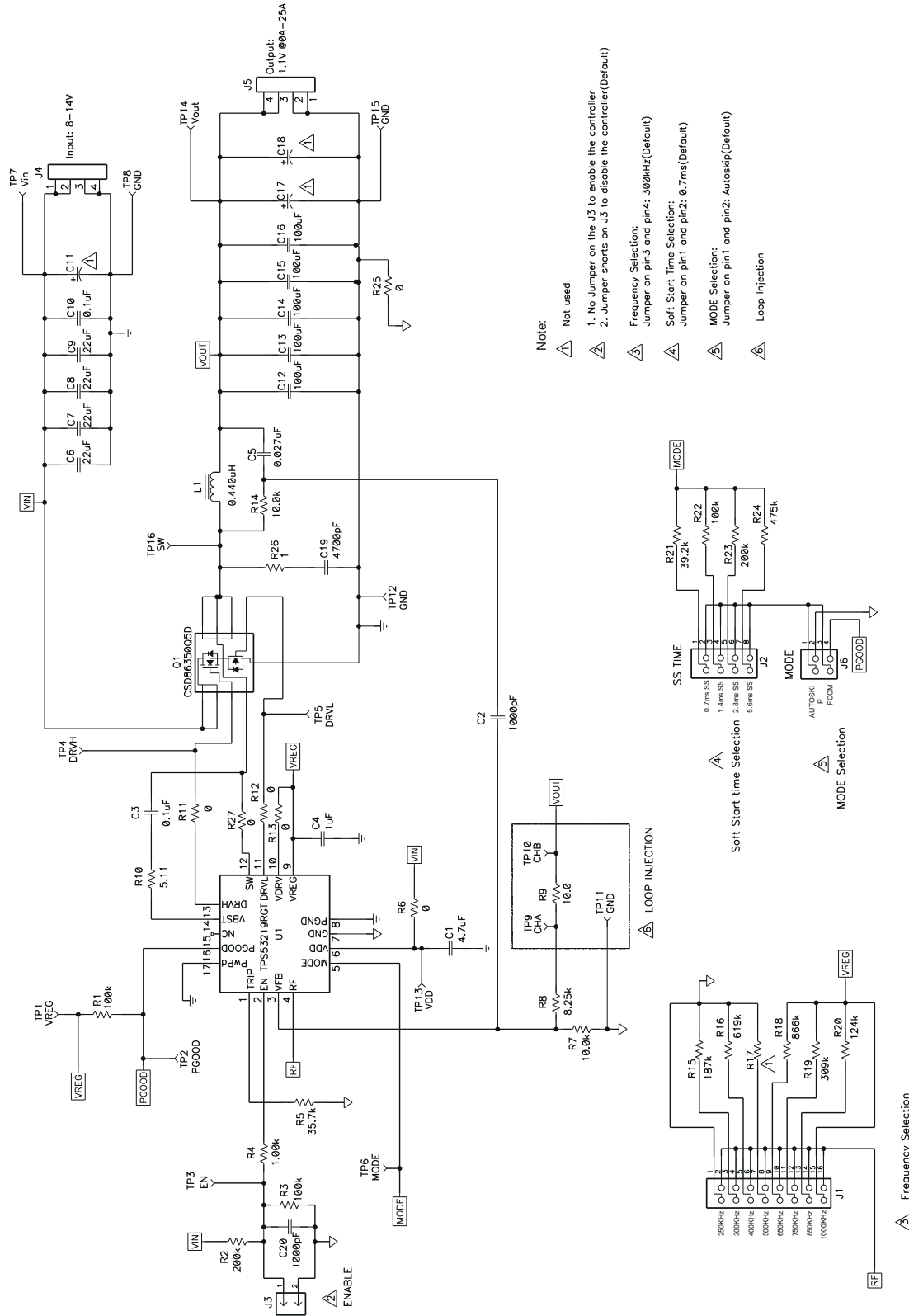

Figure 3-1. TPS53219EVM-690 Schematic

4 Test Setup

4.1 Test Equipment

Voltage Source: The input voltage source V_{IN} must be a 0-V to 14-V variable DC source capable of supplying 10 A_{DC}. Connect VIN to J4 as shown in [Figure 4-2](#).

Multimeters:

- V1: V_{IN} at TP7 (V_{IN}) and TP8 (GND)
- V2: V_{OUT} at TP14 (V_{OUT}) and TP15 (GND)
- A1: V_{IN} input current

Output Load: The output load must be an electronic constant resistance mode load capable of 0 A_{DC} to 30 A_{DC} at 1.1 V.

Oscilloscope: A digital or analog oscilloscope can be used to measure the output ripple. The oscilloscope must be set for the following:

- 1-M Ω impedance
- 20-MHz bandwidth
- AC coupling
- 2- μ s/division horizontal resolution
- 50-mV/division vertical resolution

Test points TP14 and TP15 can be used to measure the output ripple voltage by placing the oscilloscope probe tip through TP14 and holding the ground barrel on TP15 as shown in [Figure 4-1](#). Using a leaded ground connection may induce additional noise due to the large ground loop.

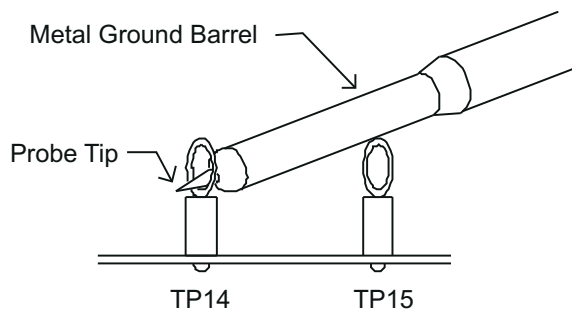

Figure 4-1. Tip and Barrel Measurement for Vout Ripple

Fan: Some of the components of this EVM can approach temperatures of 60°C during operation. A small fan capable of 200-400 LFM is recommended to reduce component temperatures while the EVM is operating. The EVM must not be probed if the fan is not running.

Recommended Wire Gauge:

1. V_{IN} to J4 (12-V input):
The recommended wire size is 1 \times AWG 14 per input connection, with the total length of wire less than four feet (2-foot input, 2-foot return).
2. J5 to LOAD:
The minimum recommended wire size is 2 \times AWG 14, with the total length of wire less than four feet (2-foot output, 2-foot return).

4.2 Recommended Test Setup

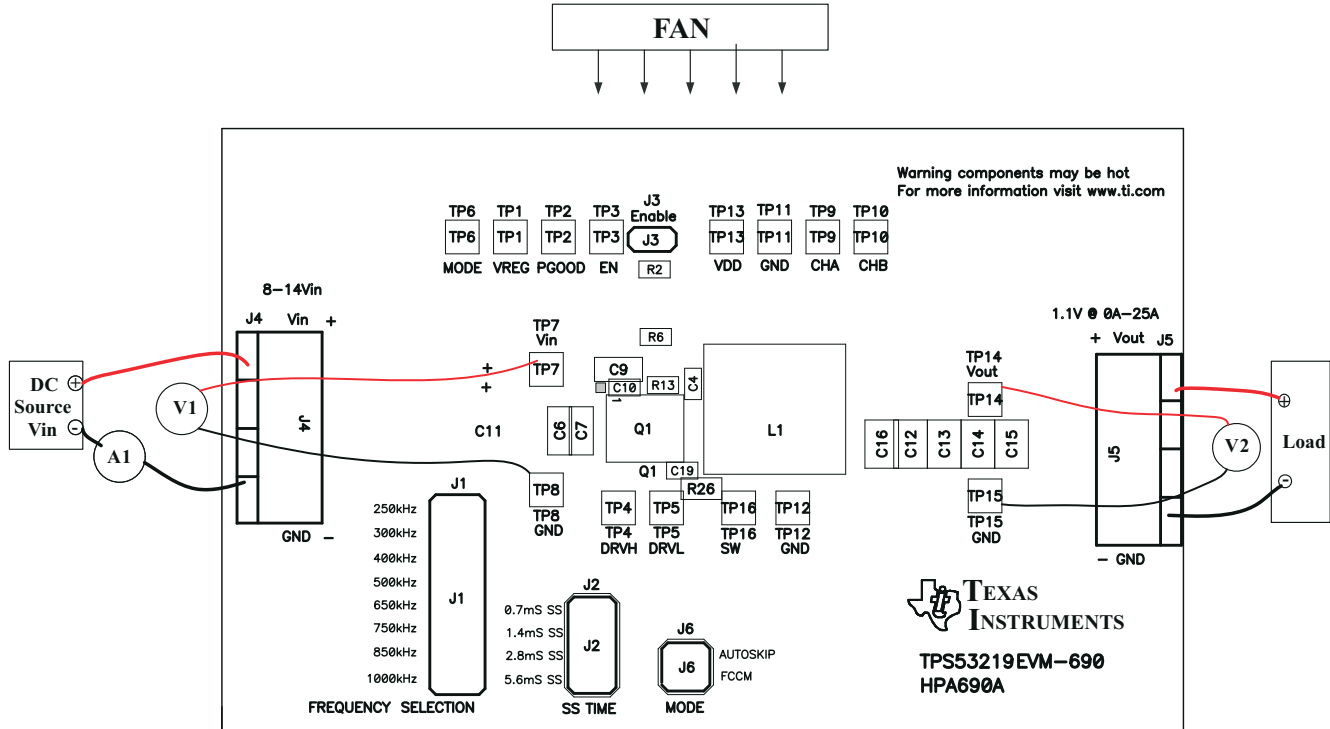

Figure 4-2. TPS53219EVM-690 Recommended Test Setup

Figure 4-2 is the recommended test setup to evaluate the TPS53219EVM-690. Working at an ESD workstation, make sure that any wrist straps, bootstraps, or mats are connected referencing the user to earth ground before power is applied to the EVM.

Input Connections:

1. Prior to connecting the DC input source V_{IN} , it is advisable to limit the source current from V_{IN} to 10-A maximum. Ensure that V_{IN} is initially set to 0 V and connected as shown in Figure 4-2.
2. Connect a voltmeter V1 at TP7 (V_{IN}) and TP8 (GND) to measure the input voltage.
3. Connect a current meter A1 to measure the input current.

Output Connections:

1. Connect the load to J5, and set the load to constant resistance mode to sink 0 A_{DC} before V_{IN} is applied.
2. Connect a voltmeter V2 at TP14 (V_{OUT}) and TP15 (GND) to measure the output voltage.

Other Connections:

Place a fan as shown in Figure 4-2 and turn on, ensuring that air is flowing across the EVM.

5 Configurations

All jumper selections must be made prior to applying power to the EVM. Users can configure this EVM per the following configurations.

5.1 Switching Frequency Selection

The switching frequency can be set by J1.

Default setting: 300 kHz

Table 5-1. Switching Frequency Selection

Jumper Set To	Resistor (RF) Connections (Ω)	Switching Frequency (kHz)
Top(1-2 pin shorted)	0	250
Second (3-4 pin shorted)	187 k	300
Third (5-6 pin shorted)	619 k	400
Fourth (7-8 pin shorted)	Open	500
Fifth (9-10 pin shorted)	866 k	650
Sixth (11-12 pin shorted)	309 k	750
Seventh (13-14 pin shorted)	124 k	850
Bottom (15-16 pin shorted)	0	1000

5.2 Soft-Start Selection

The soft-start time can be set by J2.

Default setting: 0.7 ms

Table 5-2. Soft-Start Selection

Jumper Set To	R _{MODE} Connections (Ω)	Soft-Start Time (ms)
Top (1-2 pin shorted)	39.2 k	0.7
Second (3-4 pin shorted)	100 k	1.4
Third (5-6 pin shorted)	200 k	2.8
Bottom (7-8 pin shorted)	475 k	5.6

5.3 Mode Selection

The MODE can be set by J6.

Default setting: Auto Skip

Table 5-3. MODE Selection

Jumper Set to	MODE Selection
Top (1-2 pin shorted)	Auto Skip
Bottom (3-4 pin shorted)	Forced CCM

5.4 Enable Selection

The controller can be enabled and disabled by J3.

Default setting: Jumper shorts on J3 to disable the controller

Table 5-4. Enable Selection

Jumper Set to	Enable Selection
Jumper shorts on J3	Disable the controller
No Jumper shorts on J3	Enable the controller

6 Test Procedure

6.1 Line/Load Regulation and Efficiency Measurement Procedure

1. Set up EVM as described in [Section 4](#) and [Figure 4-2](#).
2. Ensure that the load is set to constant resistance mode and to sink 0 A_{DC}.
3. Ensure that all jumper configuration settings per [Section 5](#).
4. Ensure that the jumper provided in the EVM shorts on J3 before V_{IN} is applied.
5. Increase V_{IN} from 0 V to 12 V. Use V1 to measure input voltage.
6. Remove the jumper on J3 to enable the controller.
7. Use V2 to measure V_{OUT} voltage.
8. Vary the load from 0 A_{DC} to 25 A_{DC}; V_{OUT} must remain in load regulation.
9. Vary V_{IN} from 8 V to 14 V. V_{OUT} must remain in line regulation.
10. Put the jumper on J3 to disable the controller.
11. Decrease the load to 0 A.
12. Decrease V_{IN} to 0 V.

6.2 Control Loop Gain and Phase Measurement Procedure

The TPS53219EVM-690 contains a 10-Ω series resistor in the feedback loop for loop response analysis.

1. Set up EVM as described in [Section 4](#) and [Figure 4-2](#).
2. Connect an isolation transformer to test points marked TP9 and TP10.
3. Connect a input signal amplitude measurement probe (channel A) to TP9. Connect output signal amplitude measurement probe (channel B) to TP10.
4. Connect ground lead of channel A and channel B to TP11.
5. Inject approximately 40-mV or less signal through the isolation transformer.
6. Sweep the frequency from 100 Hz to 1 MHz with 10 Hz or lower post filter. The control loop gain and phase margin can be measured.
7. Disconnect isolation transformer from bode plot test points before making other measurements (signal injection into feedback can interfere with accuracy of other measurements).

6.3 List of Test Points

Table 6-1. Functions of Each Test Points

Test Points	Name	Description
TP1	VREG	6.2-V LDO output
TP2	PGOOD	Power good
TP3	EN	Enable pin
TP4	DRVH	High-side driver output
TP5	DRVL	Low-side driver output
TP6	MODE	Soft-start and Auto skip/FCCM selection pin
TP7	VIN	V _{IN}
TP8	GND	GND for V _{IN}
TP9	CHA	Input A for loop injection
TP10	CHB	Input B for loop injection
TP11	GND	GND
TP12	GND	GND
TP13	VDD	Controller power supply input
TP14	VOUT	Output voltage
TP15	GND	GND for output voltage

6.4 Equipment Shutdown

1. Shut down the load.
2. Shut down V_{IN}.
3. Shut down FAN.

7 Performance Data and Typical Characteristic Curves

Figure 7-1 through Figure 7-9 present typical performance curves for TPS53219EVM-690.

7.1 Efficiency

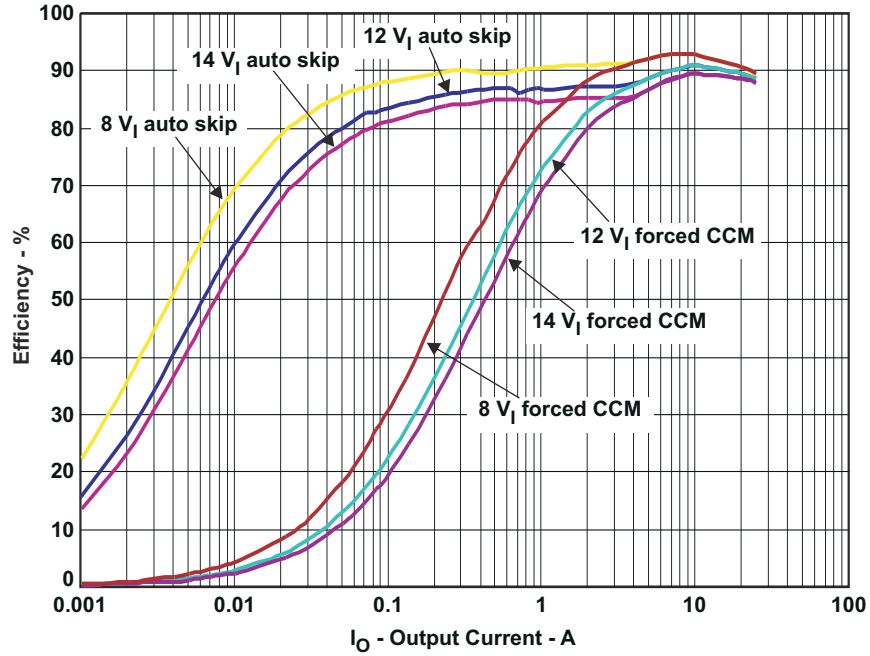

Figure 7-1. Efficiency

7.2 Load Regulation

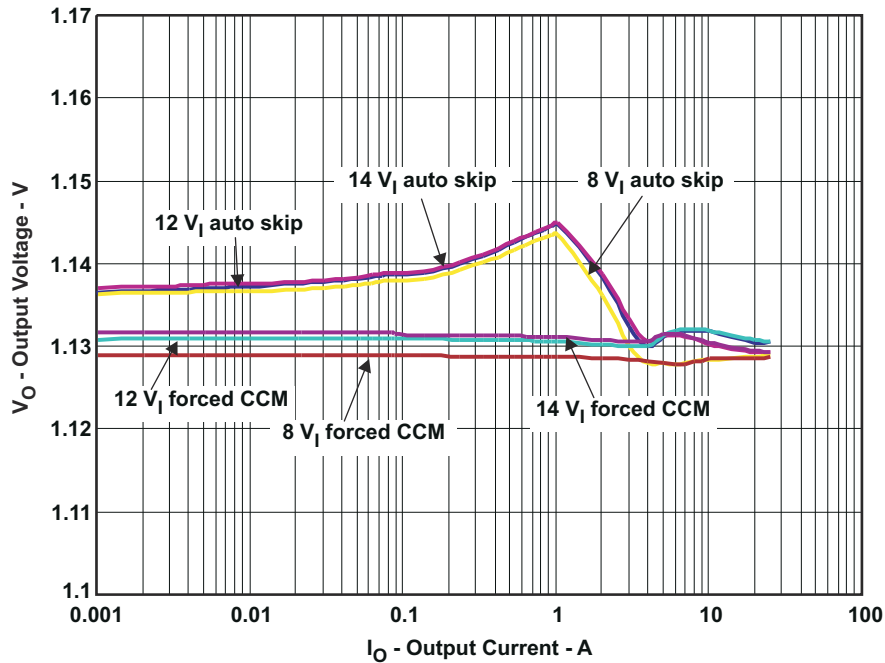

Figure 7-2. Load Regulation

7.3 Output Transient

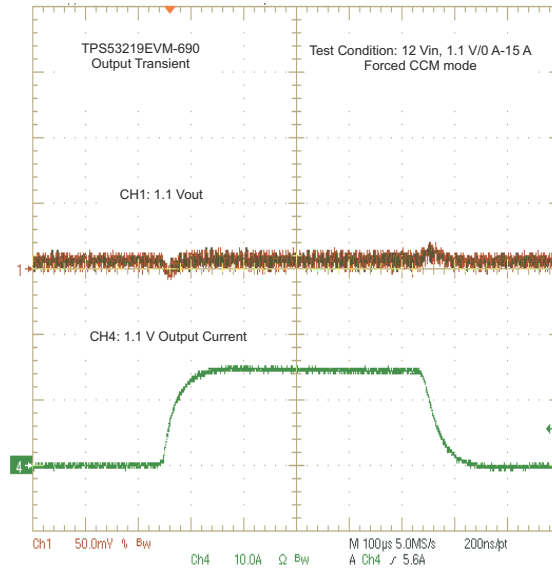

Figure 7-3. Output Load Transient

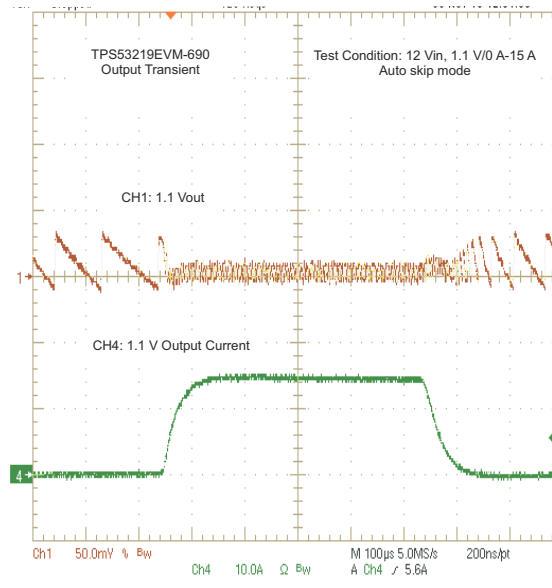

Figure 7-4. Output Load Transient

7.4 Output Ripple

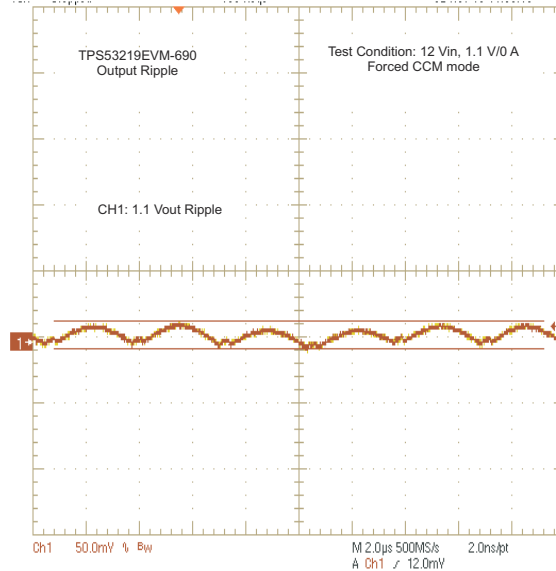

Figure 7-5. Output Ripple

7.5 Switching Node

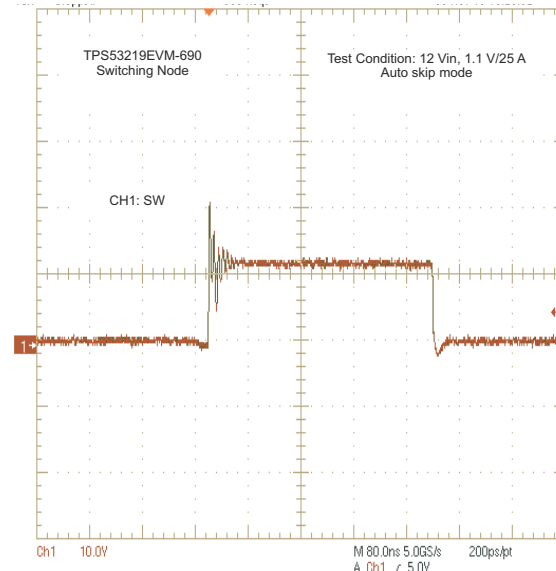

Figure 7-6. Switching Node

7.6 Enable Turn-On/Turn-Off

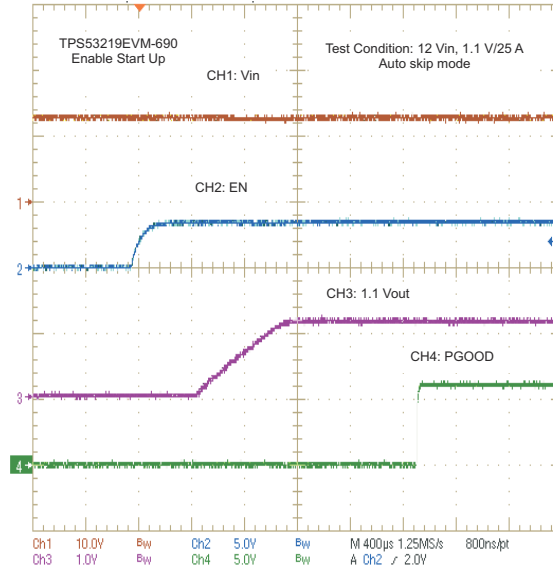

Figure 7-7. Enable Turn-On

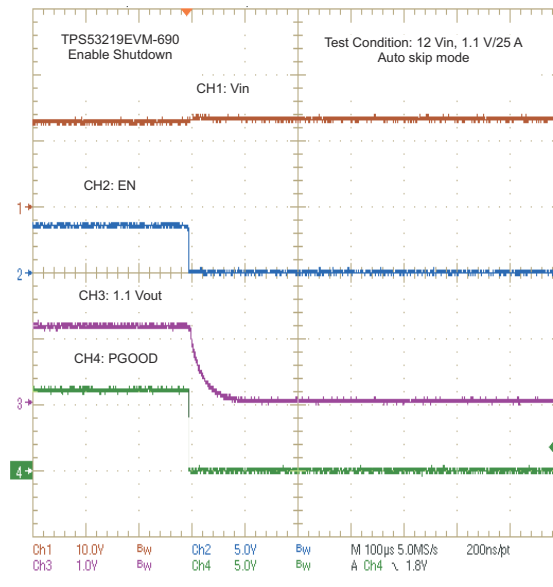

Figure 7-8. Enable Turn-Off

7.7 Output 1.1-V Prebias Turn-On

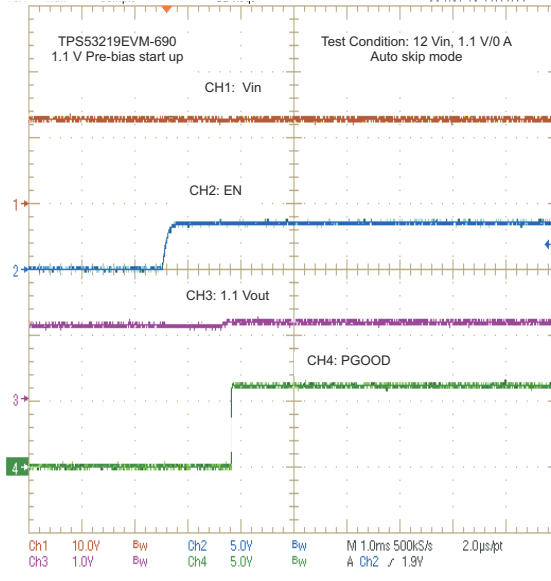

Figure 7-9. Output 1.1-V Prebias Turn-On

7.8 Bode Plot

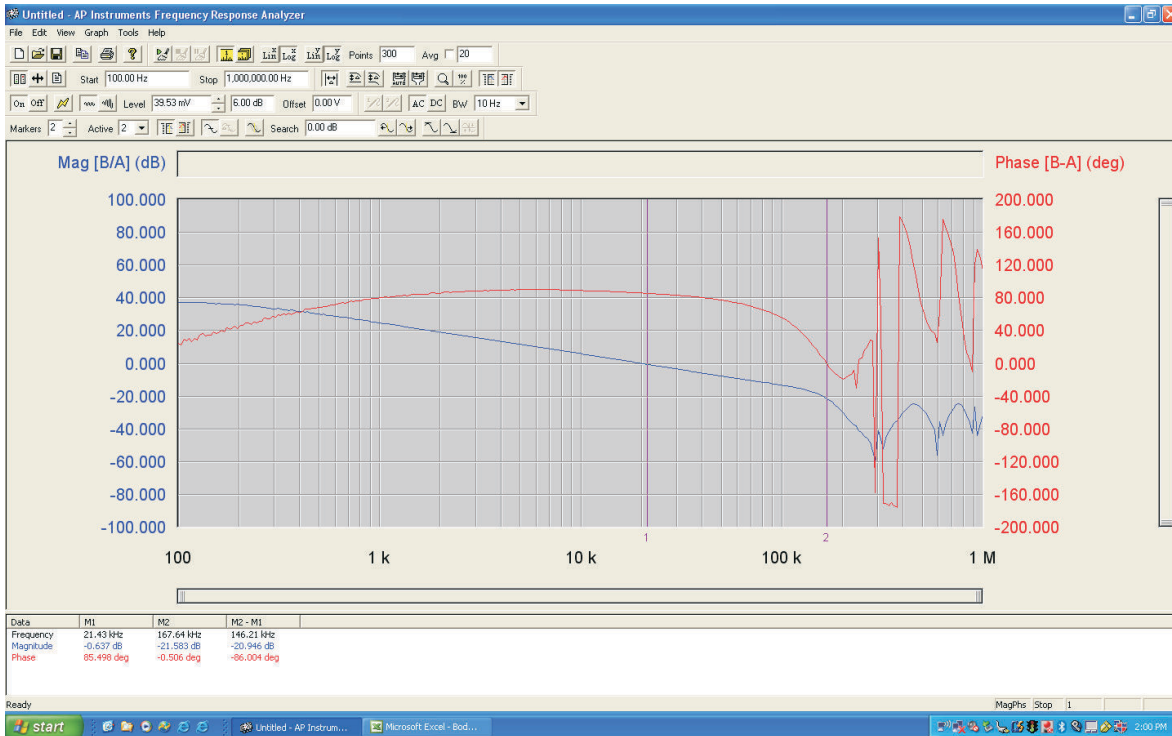

Figure 7-10. Bode Plot at 12 V_{IN}, 1.1 V/25 A

7.9 Thermal Image

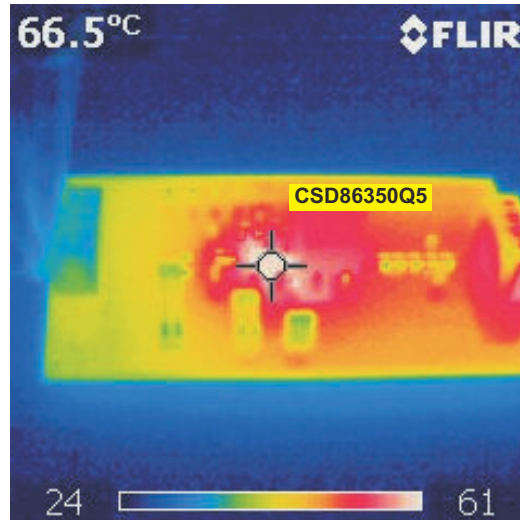

Figure 7-11. Top Board at 12 V_{IN}, 1.1 V/25 A

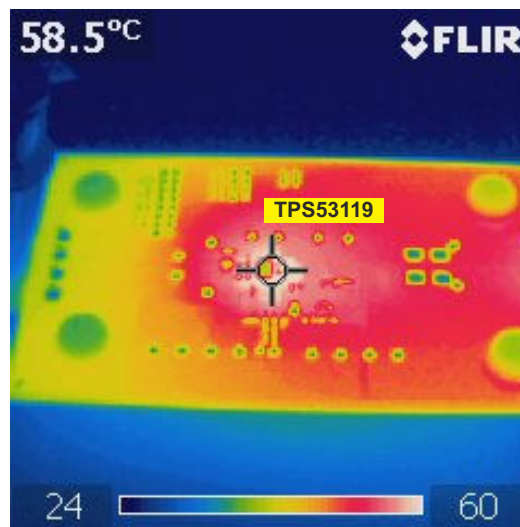

Figure 7-12. Bottom Board at 12 V_{IN}, 1.1 V/25 A

8 EVM Assembly Drawing and PCB Layout

Figure 8-1 through Figure 8-8 show the design of the TPS53219EVM-690 printed-circuit board. The EVM has been designed using six Layers, 2-oz copper circuit board.

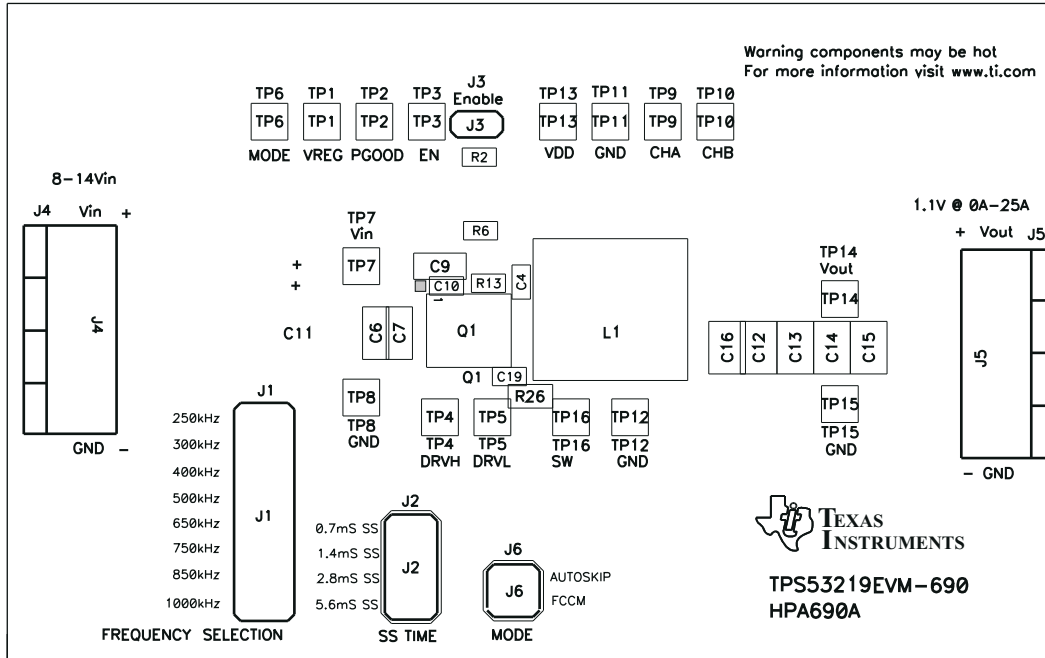

Figure 8-1. TPS53219EVM-690 Top Layer Assembly Drawing, Top View

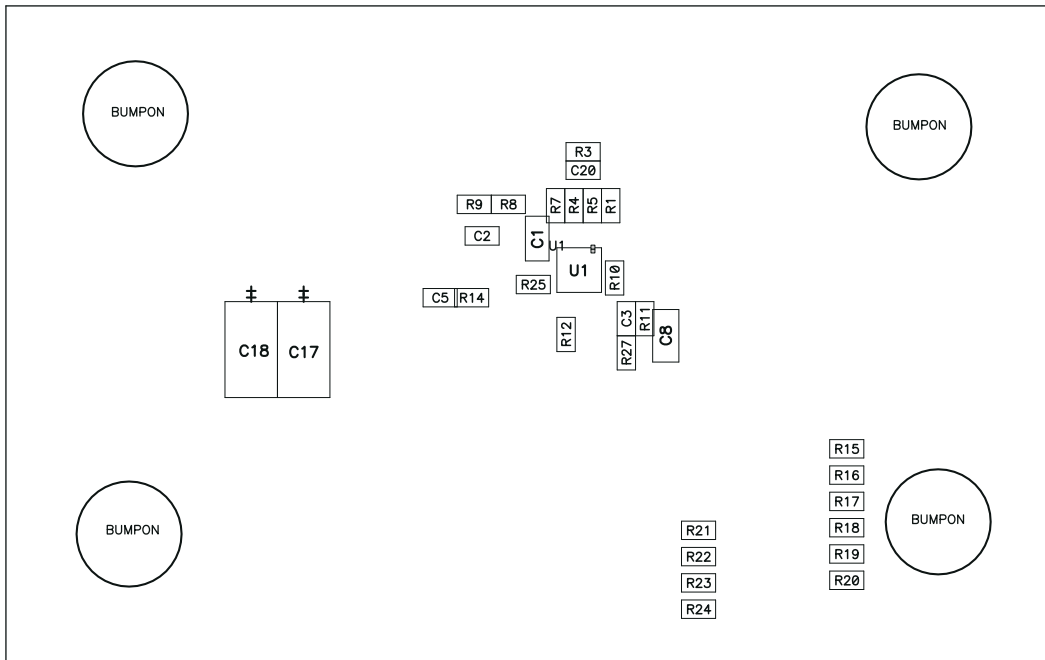

Figure 8-2. TPS53219EVM-690 Bottom Assembly Drawing, Bottom View

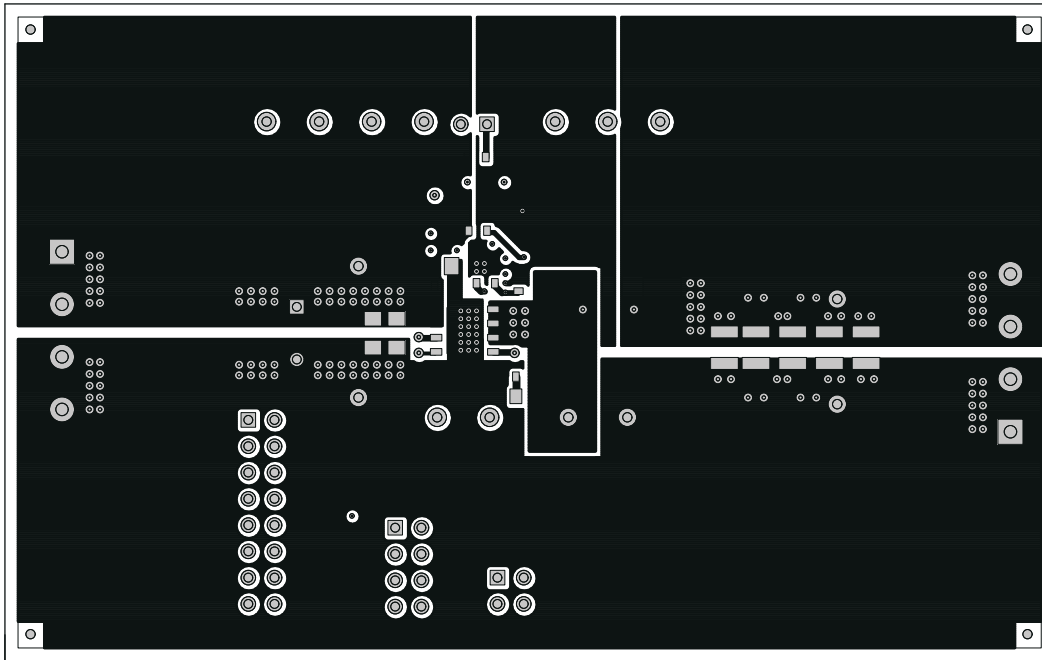

Figure 8-3. TPS53219EVM-690 Top Copper, Top View

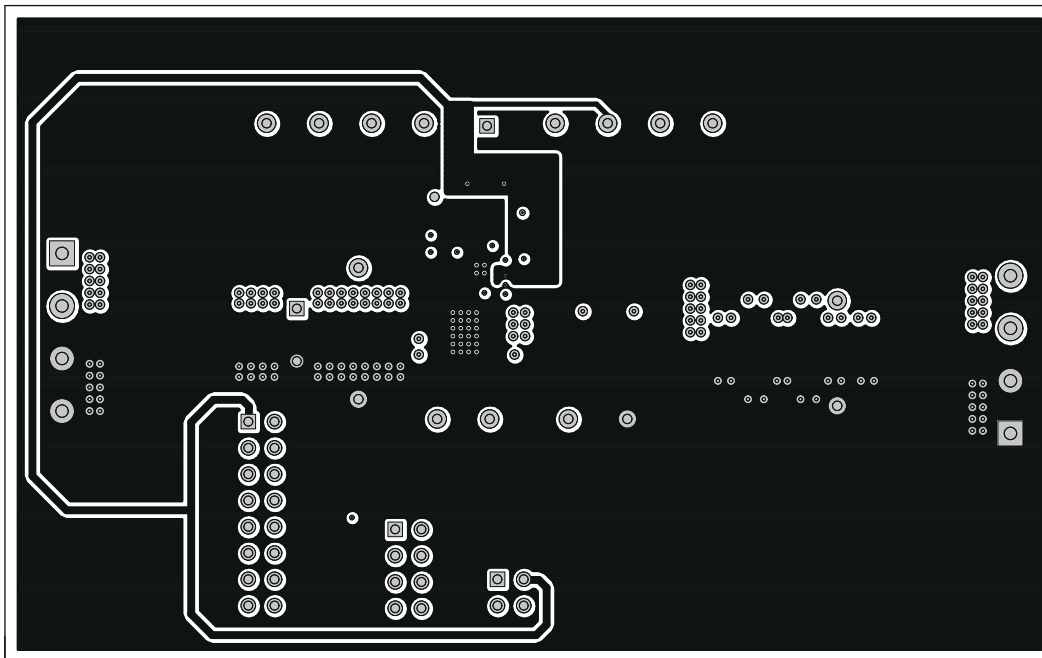

Figure 8-4. TPS53219EVM-690 Layer-2 Copper, Top View

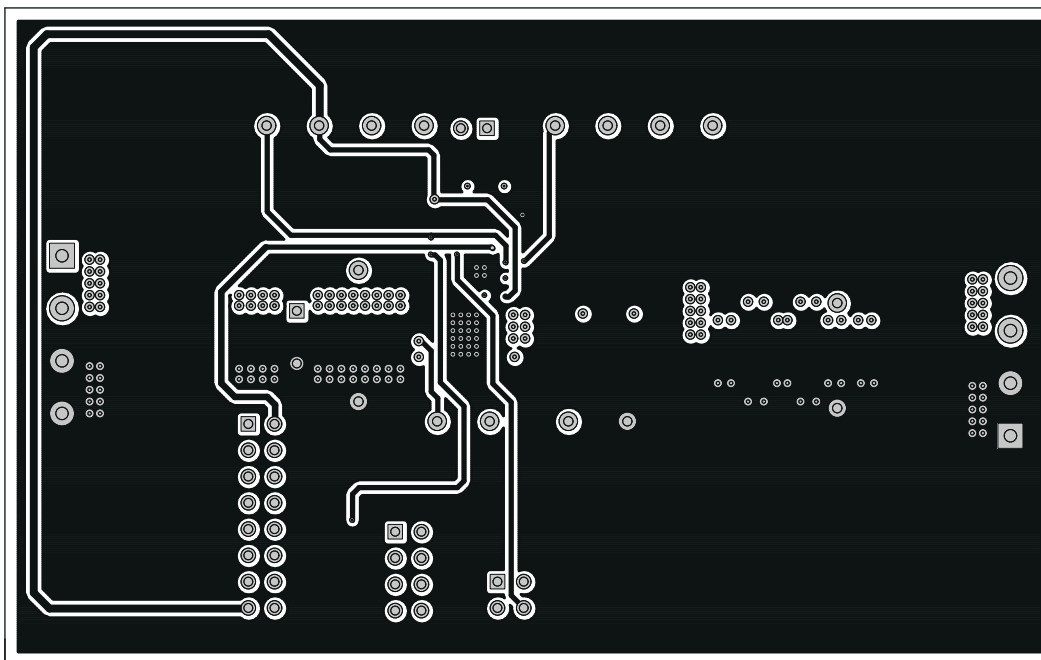

Figure 8-5. TPS53219EVM-690 Layer-3 Copper, Top View

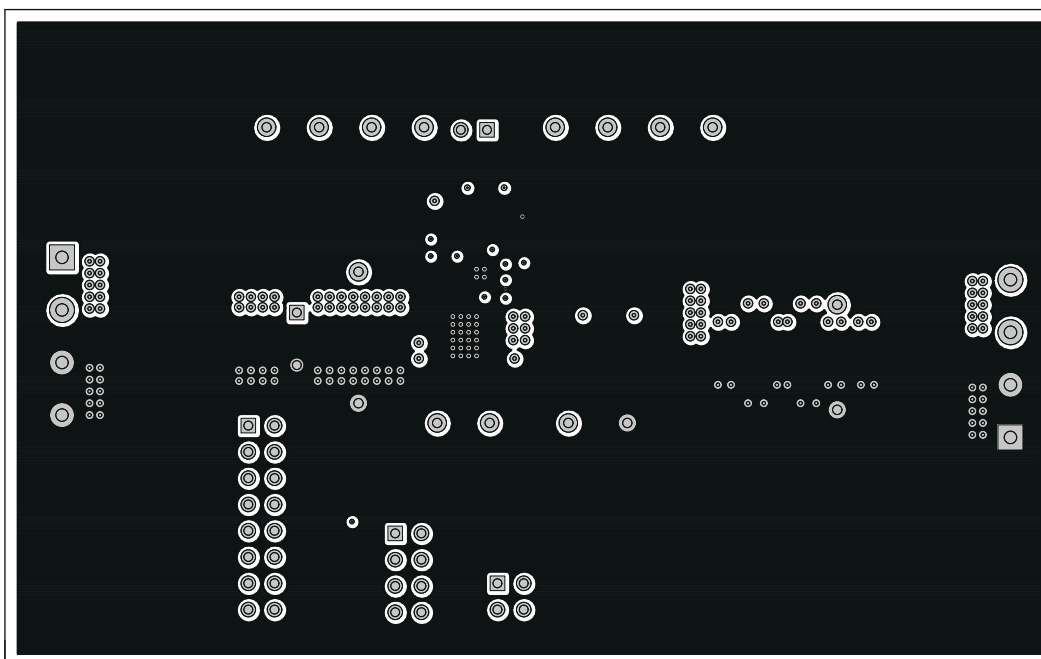

Figure 8-6. TPS53219EVM-690 Layer-4 Copper, Top View

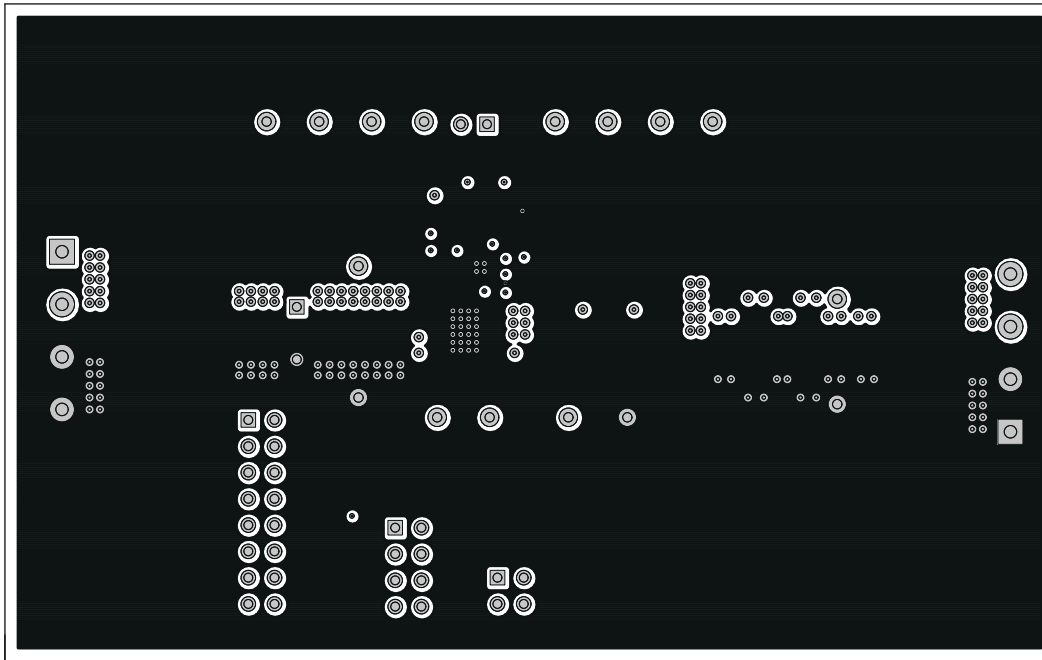

Figure 8-7. TPS53219EVM-690 Layer-5 Copper, Top View

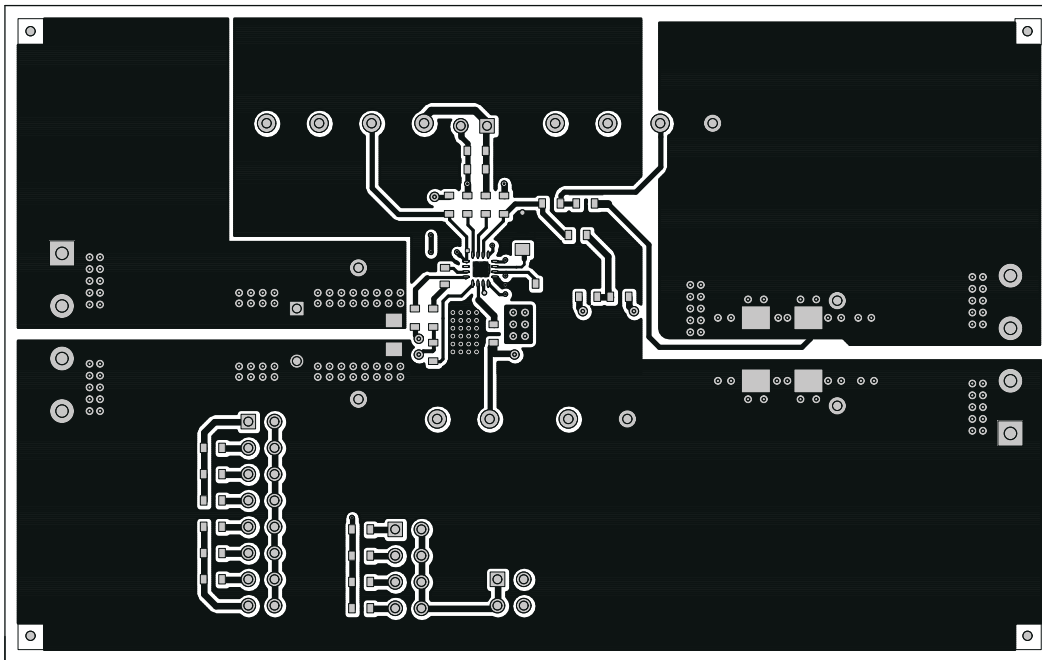

Figure 8-8. TPS53219EVM-690 Bottom Layer Copper, Top View

9 Bill of Materials

Table 9-1. The EVM Bill of Materials According to Schematic Shown in Figure 3-1

Qty	RefDes	Description	MFR	Part Number
1	C1	Capacitor, Ceramic, 4.7 μ F, 16 V, X5R, 20%, 0805	STD	STD
5	C12–C16	Capacitor, Ceramic, 100 μ F, 6.3 V, X5R, 20%, 1210	Murata	GRM32ER60J107ME20L
1	C19	Capacitor, Ceramic, 4700 pF, 50 V, X7R, 20%, 0603	STD	STD
2	C2, C20	Capacitor, Ceramic, 1000 pF, 25 V, X7R, 10%, 0603	STD	STD
2	C3, C10	Capacitor, Ceramic, 0.1 μ F, 50 V, X7R, 10%, 0603	STD	STD
1	C5	Capacitor, Ceramic, 0.027 μ F, 50 V, X7R, 10%, 0603	STD	STD
1	C4	Capacitor, Ceramic, 1 μ F, 16 V, X7R, 10%, 0603	STD	STD
4	C6–C9	Capacitor, Ceramic, 22 μ F, 16 V, X5R, 20%, 1206	Murata	GRM31CR61C226ME15L
1	L1	Inductor, SMT, 0.44 μ H, 30 A, 0.0032 Ω , 0.530" \times 0.510"	Pulse or E&E Magnetic	PA0513-441NLT or 831-02990F
1	Q1	MOSFET, Dual N-chan, Power Block, 25 V, 40 A, QFN-8 Power	TI	CSD86350Q5D
3	R1, R3, R22	Resistor, Chip, 100 k, 1/16W, 1%, 0603	STD	STD
1	R15	Resistor, Chip, 187 k, 1/16W, 1%, 0603	STD	STD
1	R16	Resistor, Chip, 619 k, 1/16W, 1%, 0603	STD	STD
1	R18	Resistor, Chip, 866 k, 1/16W, 1%, 0603	STD	STD
1	R19	Resistor, Chip, 309 k, 1/16W, 1%, 0603	STD	STD
2	R2, R23	Resistor, Chip, 200 k, 1/16W, 1%, 0603	STD	STD
1	R20	Resistor, Chip, 124 k, 1/16W, 1%, 0603	STD	STD
1	R21	Resistor, Chip, 39.2 k, 1/16W, 1%, 0603	STD	STD
1	R24	Resistor, Chip, 475 k, 1/16W, 1%, 0603	STD	STD
1	R26	Resistor, Chip, 1, 1/10W, 5%, 0805	STD	STD
1	R4	Resistor, Chip, 1.00 k, 1/16W, 1%, 0603	STD	STD
1	R5	Resistor, Chip, 35.7 k, 1/16W, 1%, 0603	STD	STD
6	R6, R11–R13, R25, R27	Resistor, Chip, 0, 1/16W, 5%, 0603	STD	STD
1	R10	Resistor, Chip, 5.11, 1/16W, 1%, 0603	STD	STD
2	R7, R14	Resistor, Chip, 10.0 k, 1/16W, 1%, 0603	STD	STD
1	R8	Resistor, Chip, 8.25 k, 1/16W, 1%, 0603	STD	STD
1	R9	Resistor, Chip, 10, 1/16W, 1%, 0603	STD	STD
1	U1	IC, Single Synchronous Step-Down Controller, QFN-16	TI	TPS53219RGT

10 Revision History

NOTE: Page numbers for previous revisions may differ from page numbers in the current version.

Changes from Revision * (January 2011) to Revision A (December 2021)	Page
• Updated the numbering format for tables, figures, and cross-references throughout the document.....	3
• Updated the user's guide title.....	3
• Edited user's guide for clarity.....	3

IMPORTANT NOTICE AND DISCLAIMER

TI PROVIDES TECHNICAL AND RELIABILITY DATA (INCLUDING DATASHEETS), DESIGN RESOURCES (INCLUDING REFERENCE DESIGNS), APPLICATION OR OTHER DESIGN ADVICE, WEB TOOLS, SAFETY INFORMATION, AND OTHER RESOURCES "AS IS" AND WITH ALL FAULTS, AND DISCLAIMS ALL WARRANTIES, EXPRESS AND IMPLIED, INCLUDING WITHOUT LIMITATION ANY IMPLIED WARRANTIES OF MERCHANTABILITY, FITNESS FOR A PARTICULAR PURPOSE OR NON-INFRINGEMENT OF THIRD PARTY INTELLECTUAL PROPERTY RIGHTS.

These resources are intended for skilled developers designing with TI products. You are solely responsible for (1) selecting the appropriate TI products for your application, (2) designing, validating and testing your application, and (3) ensuring your application meets applicable standards, and any other safety, security, regulatory or other requirements.

These resources are subject to change without notice. TI grants you permission to use these resources only for development of an application that uses the TI products described in the resource. Other reproduction and display of these resources is prohibited. No license is granted to any other TI intellectual property right or to any third party intellectual property right. TI disclaims responsibility for, and you fully indemnify TI and its representatives against any claims, damages, costs, losses, and liabilities arising out of your use of these resources.

TI's products are provided subject to [TI's Terms of Sale](#), [TI's General Quality Guidelines](#), or other applicable terms available either on ti.com or provided in conjunction with such TI products. TI's provision of these resources does not expand or otherwise alter TI's applicable warranties or warranty disclaimers for TI products. Unless TI explicitly designates a product as custom or customer-specified, TI products are standard, catalog, general purpose devices.

TI objects to and rejects any additional or different terms you may propose.

Copyright © 2026, Texas Instruments Incorporated

Last updated 10/2025