

## **AN-2084 LMZ1420xEXT / LMZ1200xEXT Evaluation Board**

---

---

---

### **1 Introduction**

The LMZ1420xEXT and LMZ1200xEXT SIMPLE SWITCHER® power modules are easy-to-use DC-DC solution capable of driving up to a 3A load with exceptional power conversion efficiency, output voltage accuracy, line and load regulation. They are available in an innovative package that enhances thermal performance and allows for hand or machine soldering.

The LMZ14203EXT/2EXT/1EXT can accept an input voltage rail between 6V and 42V and the LMZ12003EXT/2EXT/1EXT can accept an input voltage rail between 4.5V and 20V. The devices can deliver an adjustable and highly accurate output voltage as low as 0.8V and as high as 6V. The control structure is constant on-time with input voltage feed forward. This creates a nearly constant switching frequency across the input voltage range. The control loop operates well with low ESR output capacitors such as ceramics. An output feed-forward capacitor across the upper feedback resistor trims for optimum transient response. The precision enable input allows for programmable UVLO of the input supply. The external soft-start capacitor facilitates controlled startup output rise time. The LMZ1420xEXT and LMZ1200xEXT family is a reliable and robust solution with the following features: lossless cycle-by-cycle valley current limit to protect for over current or short-circuit fault, thermal shutdown, input under-voltage lock-out, and will start up into a pre-biased output. The LMZ1420xEXT and LMZ1200xEXT families are shock and vibration certified and rated for operation down to  $-55^{\circ}\text{C}$ .

### **2 Board Specifications**

- LMZ1420xEXT  $V_{\text{IN}} = 6\text{V to }42\text{V}$
- LMZ1420xEXT enable UVLO = 8V
- LMZ1420xEXT  $V_{\text{OUT}} = 3.3\text{V}$
- LMZ1200xEXT  $V_{\text{IN}} = 4.5\text{V to }20\text{V}$
- LMZ1200xEXT enable UVLO = 4.5V
- LMZ1200xEXT  $V_{\text{OUT}} = 1.8\text{V}$
- Operates at full load up to  $80^{\circ}\text{C}$  ambient at 12V input
- $\theta_{\text{JA}} = 20^{\circ}\text{C} / \text{W}$ ,  $\theta_{\text{JC}} = 1.9^{\circ}\text{C} / \text{W}$
- Designed on four layers, all four layers are 1 oz. copper weight
- The two internal ground planes are identical
- Measures 1.705 in. x 3.03 in. (4.33 cm x 7.7cm) and is 62mil (.062") thick of FR4 laminate material

For additional circuit modifications refer to the Design Consideration section of the LMZ1420xEXT or LMZ1200xEXT data sheet. For negative output voltage connections see AN-2027.

### **3 Additional Footprints**

Additional component mounting pads are available to experiment with alternative  $C_{\text{in}}$  and  $C_{\text{out}}$  combinations or a zener clamp on the enable input. See [Figure 6](#) for corresponding schematic locations.

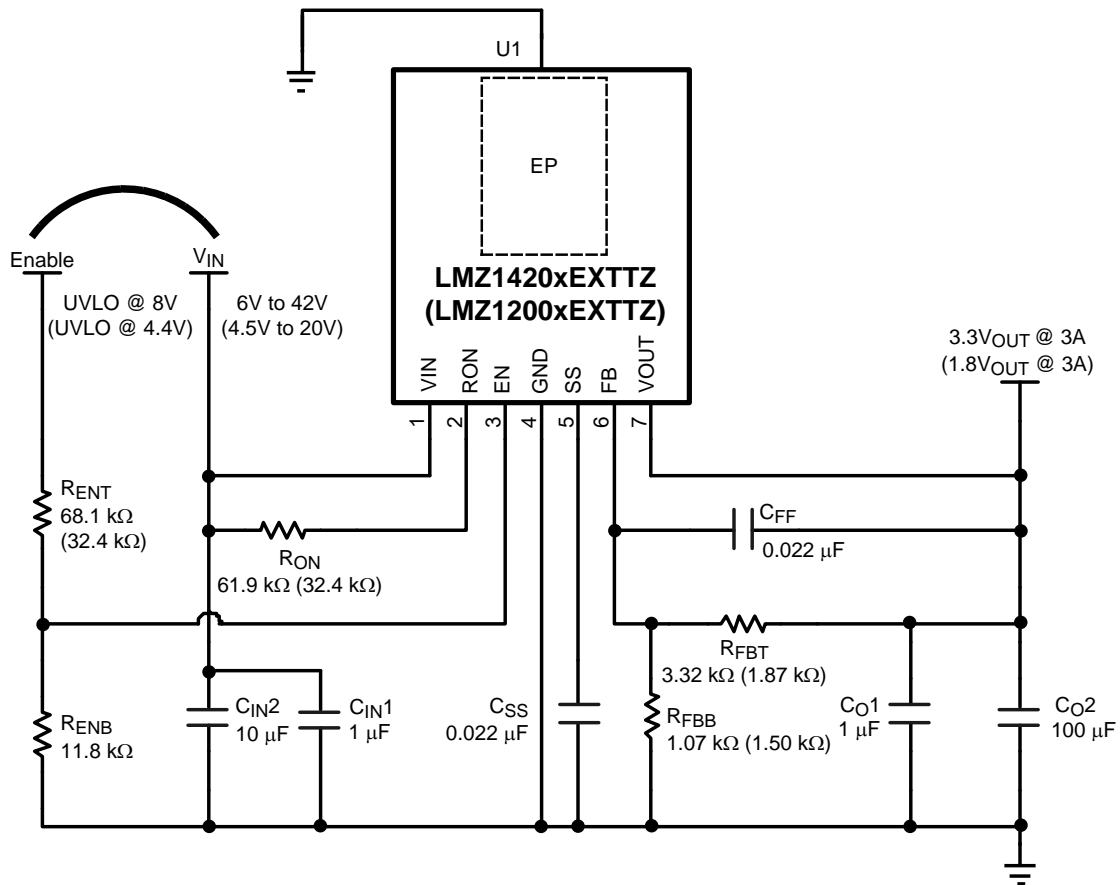

**Figure 1. Evaluation Board Schematic**  
(LMZ1200xEXT 1.8V application values shown in parentheses)

## 4 Bill of Materials

**Table 1. LMZ1420xEXT Bill of Materials,  $V_{IN} = 8V$  to  $42V$ ,  $V_{OUT} = 3.3V$ ,  $I_{OUT (MAX)} = 3A / 2A / 1A$** 

Designator	Description	Case Size	Manufacturer	Manufacturer P/N	Quantity
U1	SIMPLE SWITCHER®	PFM-7	Texas Instruments	LMZ14203 or LMZ14202 or LMZ14201	1
$C_{IN4}, C_{O1}$	1 $\mu F$ , X7R, 50V	1206	Taiyo Yuden	UMK316B7105KL-T	2
$C_{IN2}$	10 $\mu F$ , X5R, 50V	1210	Taiyo Yuden	UMK325BJ106MM-T	1
$C_{O2}$	100 $\mu F$ , X5R, 6.3V	1210	Taiyo Yuden	JMK325BJ107MM-T	1
$C_{SS}, C_{FF}$	0.022 $\mu F$ , X7R, 100V	0805	AVX	08051C223JAT2A	2
$R_{ENB}$	11.8k	0805	Panasonic	ERJ-6ENF1182V	1
$R_{ENT}$	68.1 k $\Omega$	0805	Panasonic	ERJ-6ENF6812V	1
$R_{FBT}$	3.32 k $\Omega$	0805	Vishay-Dale	CRCW08053K32FKEA	1
$R_{FBB}$	1.07 k $\Omega$	0805	Panasonic	CRCW080534K8FKEA	1
$R_{ON}$	61.9 k $\Omega$	0805	Panasonic	ERJ-6ENF6192V	1

**Table 2. LMZ1200xEXT Bill of Materials,  $V_{IN} = 4.5$  to  $20V$ ,  $V_{OUT} = 1.8V$ ,  $I_{OUT (MAX)} = 3A / 2A / 1A$** 

Designator	Description	Case Size	Manufacturer	Manufacturer P/N	Quantity
U1	SIMPLE SWITCHER®	PFM-7	Texas Instruments	LMZ12003 or LMZ12002 or LMZ12001	1
$C_{IN4}, C_{O1}$	1 $\mu F$ , X7R, 50V	1206	Taiyo Yuden	UMK316B7105KL-T	2
$C_{IN2}$	10 $\mu F$ , X5R, 50V	1210	Taiyo Yuden	UMK325BJ106MM-T	1
$C_{O2}$	100 $\mu F$ , X5R, 6.3V	1210	Taiyo Yuden	JMK325BJ107MM-T	1
$C_{SS}, C_{FF}$	0.022 $\mu F$ , X7R, 100V	0805	AVX	08051C223JAT2A	2
$R_{ENB}$	11.8k	0805	Panasonic	ERJ-6ENF1182V	1
$R_{ENT}$	32.4K $\Omega$	0805	Panasonic	ERJ-6ENF3242V	1
$R_{FBT}$	1.87 k $\Omega$	0805	Vishay-Dale	CRCW08051K87FKEA	1
$R_{FBB}$	1.50 k $\Omega$	0805	Panasonic	CRCW08051K50FKEA	1
$R_{ON}$	32.4K $\Omega$	0805	Panasonic	ERJ-6ENF3242V	1

## 5 Performance Characteristics

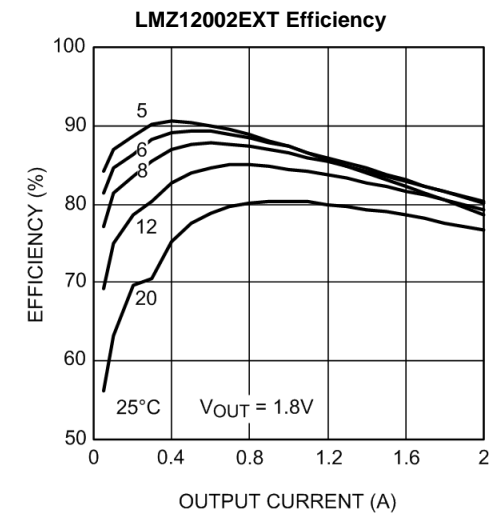
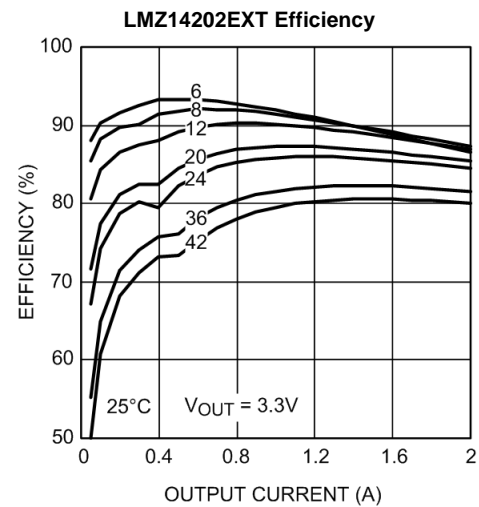
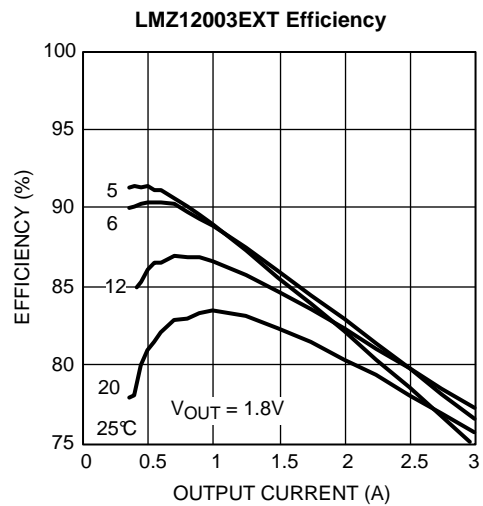
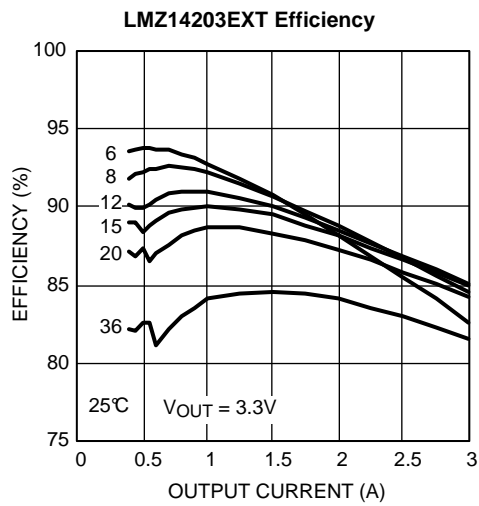
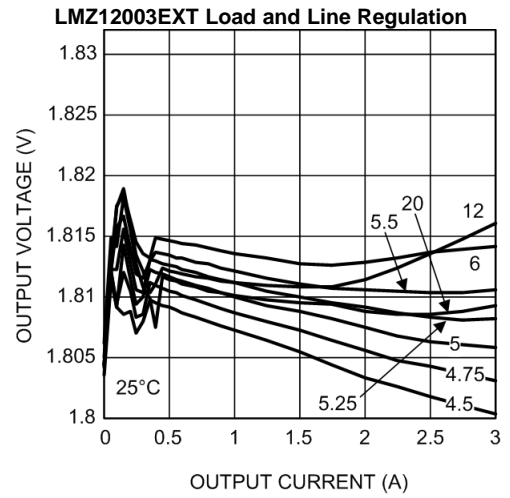
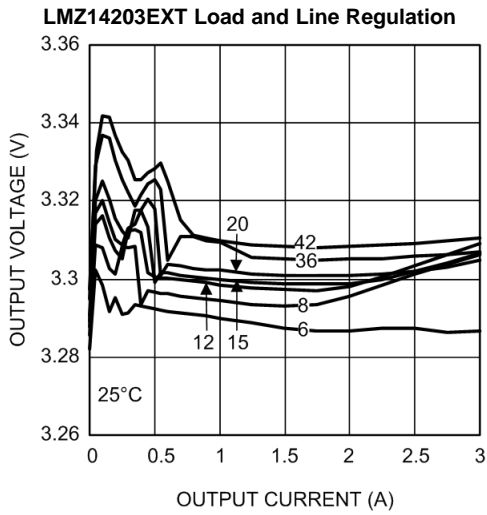

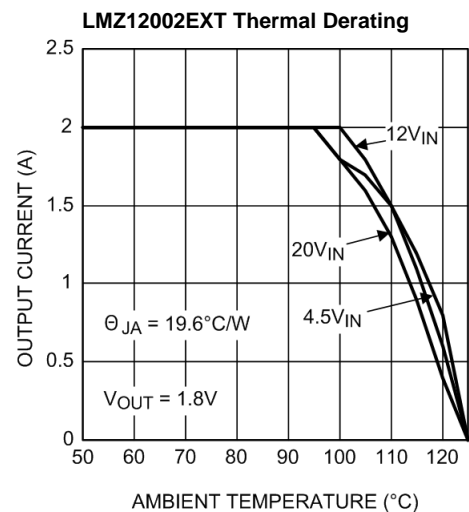
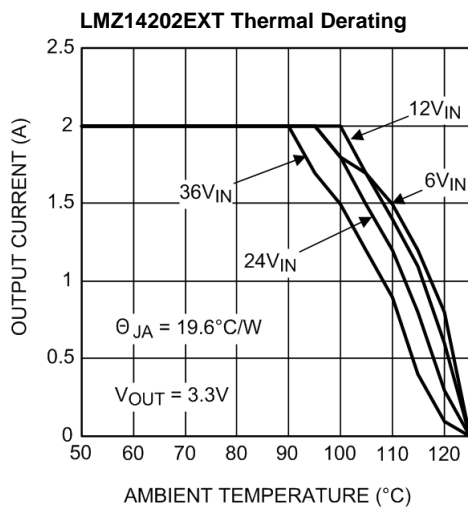
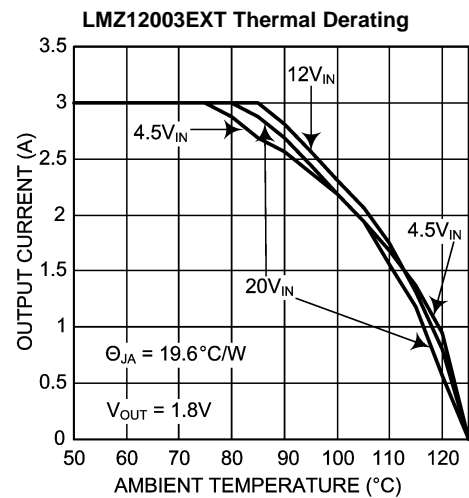
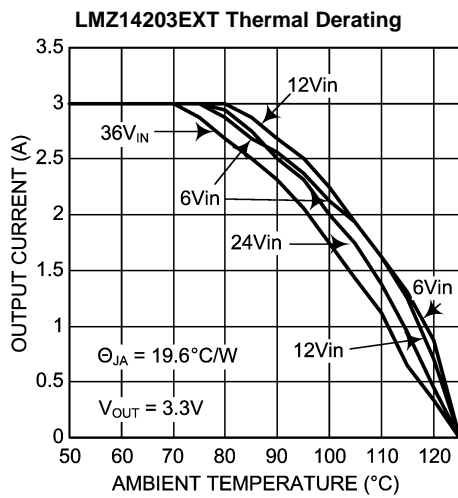
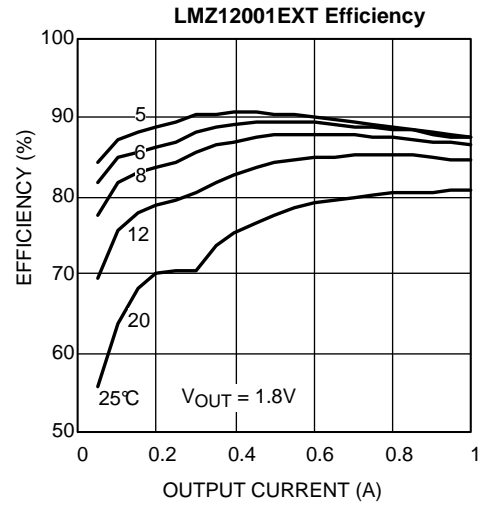
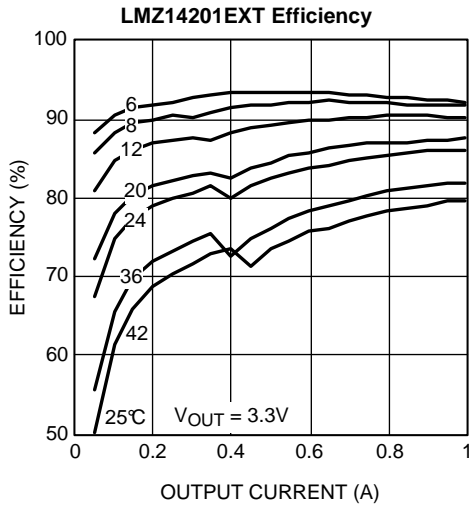

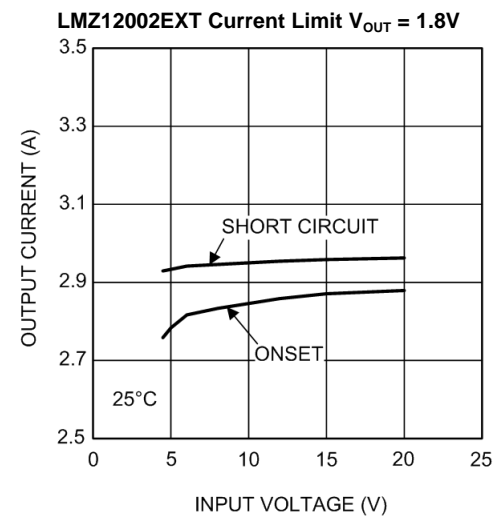
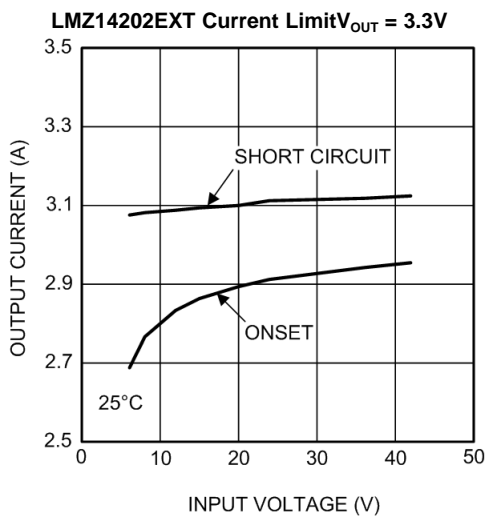
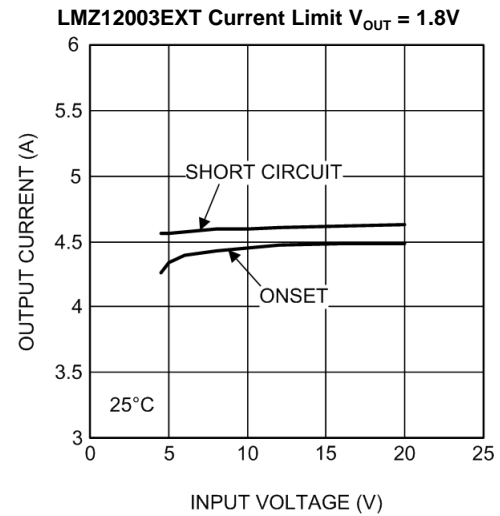
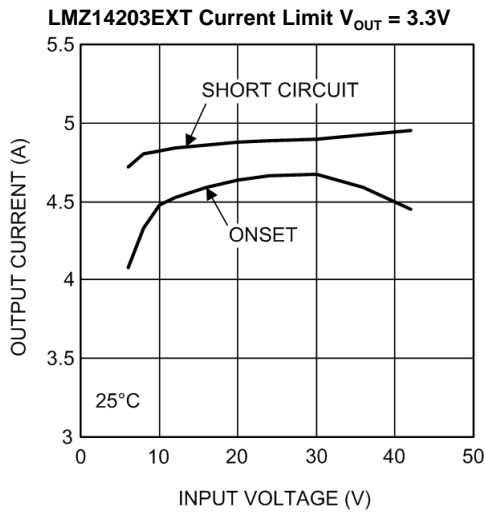
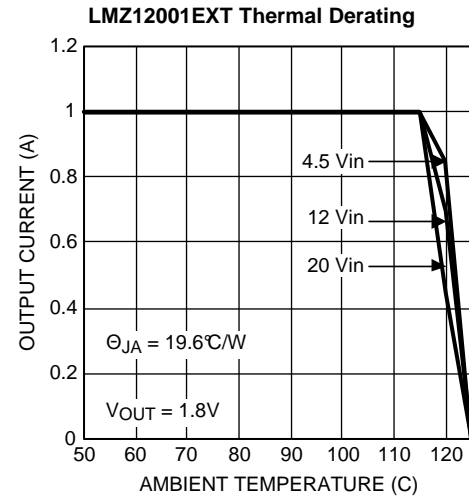
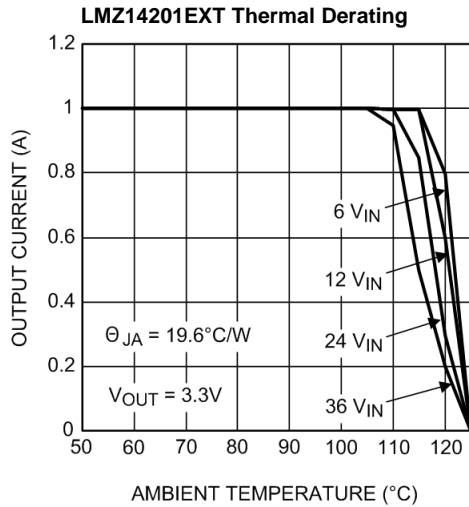

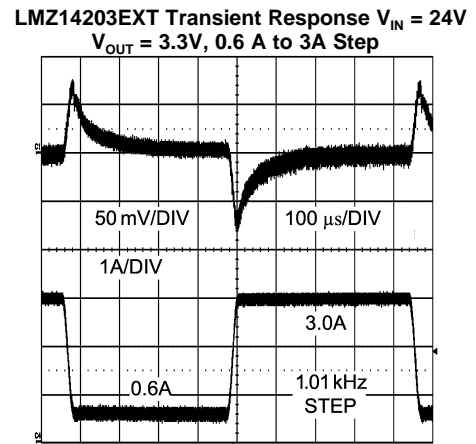
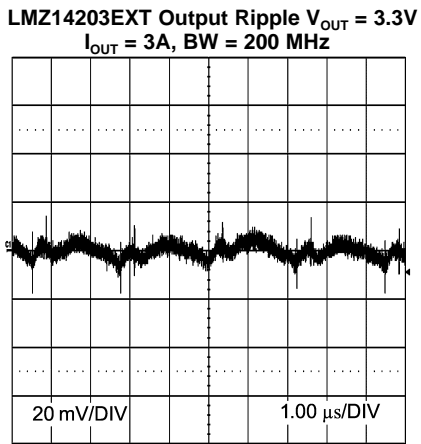
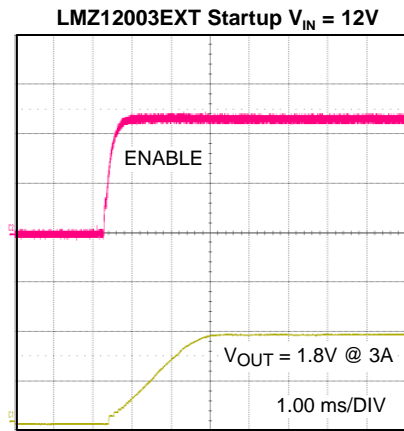
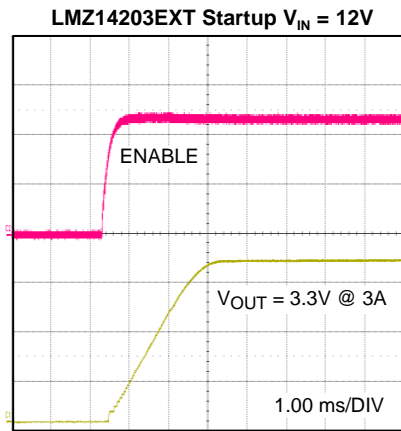
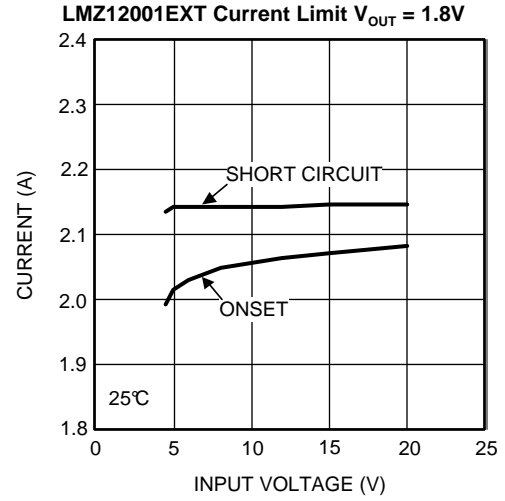
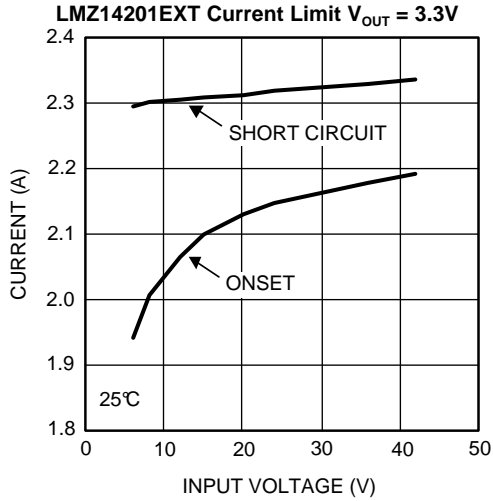

## 6 PCB Layout Diagrams

Gerber and CAD files can be download from the LMZ14203EXT product folder.

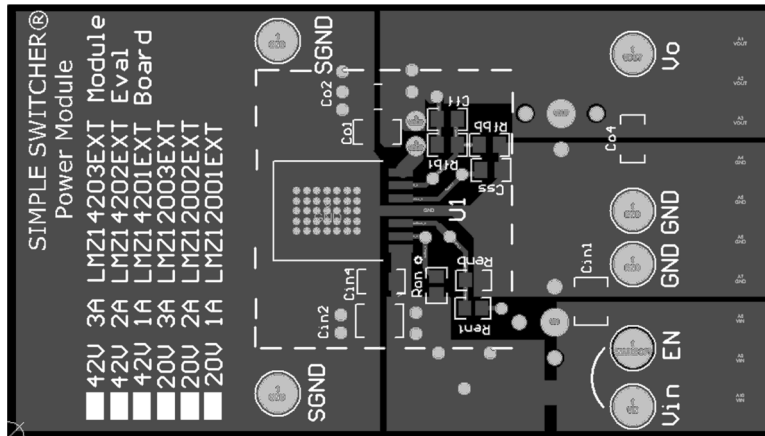

**Figure 2. Top Layer**

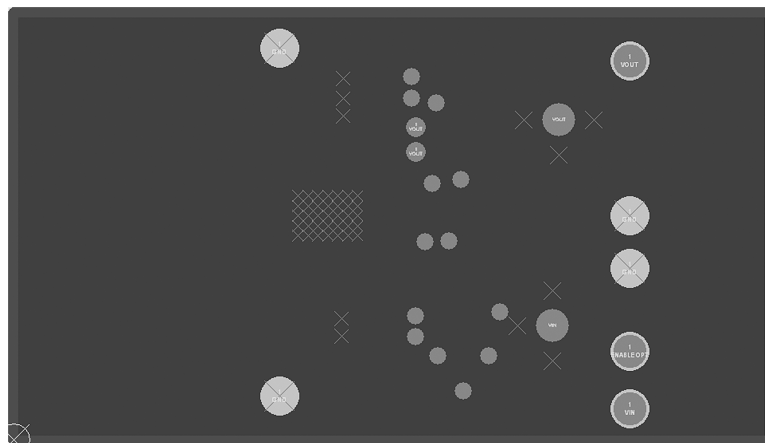

**Figure 3. Internal Layer I (Ground)  
Heat Sinking Layer**

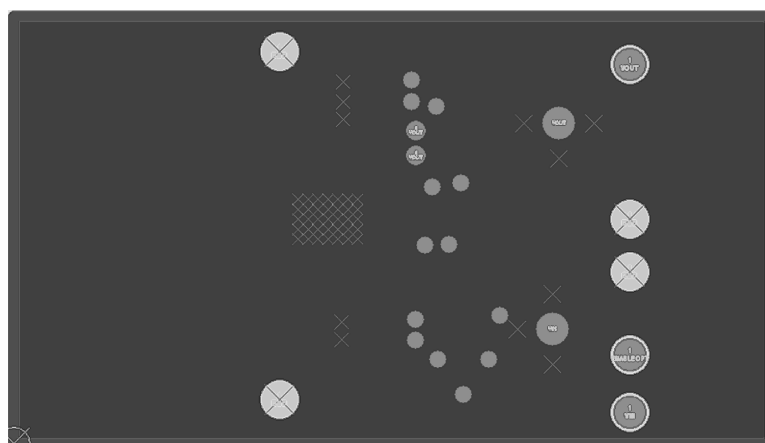

**Figure 4. Internal Layer II (Ground)  
Heat Sinking Layer**



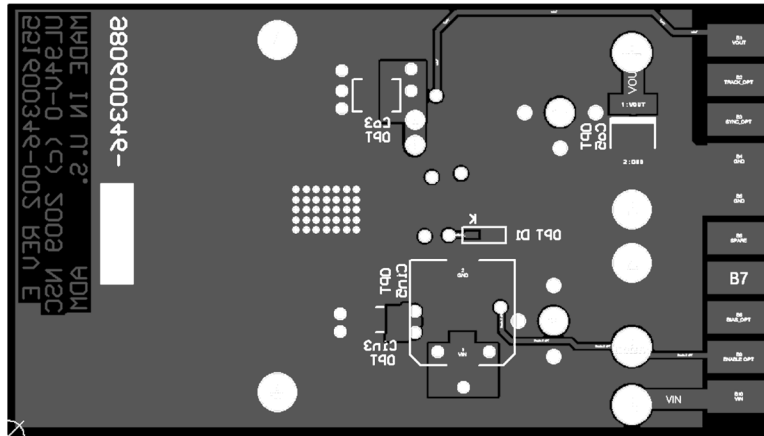

Figure 5. Bottom Layer (Ground and Routing)  
Heat Sinking Layer

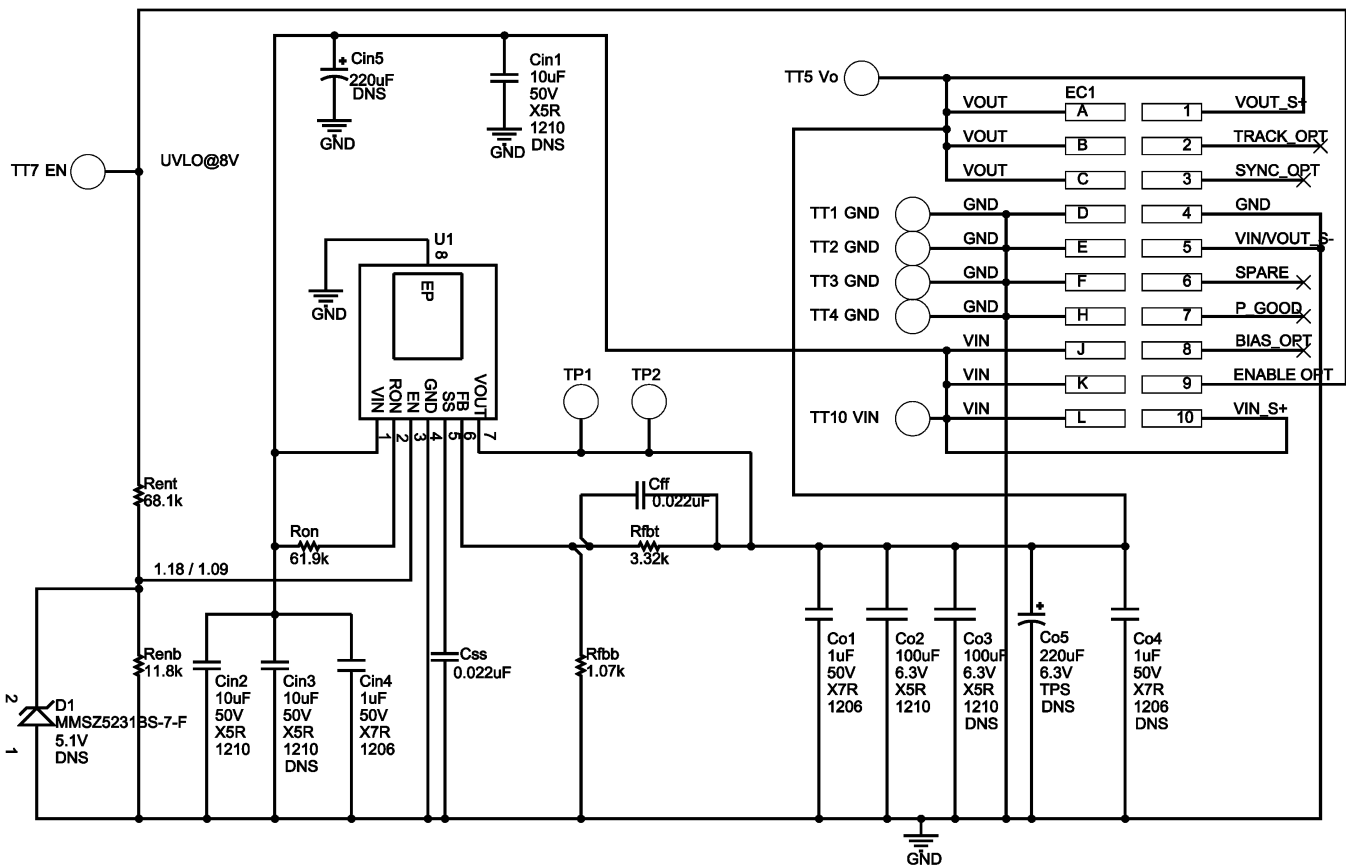

Figure 6. LMZ14203EXT PCB CAD package schematic  
DNS = Component not installed

## IMPORTANT NOTICE

Texas Instruments Incorporated and its subsidiaries (TI) reserve the right to make corrections, enhancements, improvements and other changes to its semiconductor products and services per JESD46, latest issue, and to discontinue any product or service per JESD48, latest issue. Buyers should obtain the latest relevant information before placing orders and should verify that such information is current and complete. All semiconductor products (also referred to herein as "components") are sold subject to TI's terms and conditions of sale supplied at the time of order acknowledgment.

TI warrants performance of its components to the specifications applicable at the time of sale, in accordance with the warranty in TI's terms and conditions of sale of semiconductor products. Testing and other quality control techniques are used to the extent TI deems necessary to support this warranty. Except where mandated by applicable law, testing of all parameters of each component is not necessarily performed.

TI assumes no liability for applications assistance or the design of Buyers' products. Buyers are responsible for their products and applications using TI components. To minimize the risks associated with Buyers' products and applications, Buyers should provide adequate design and operating safeguards.

TI does not warrant or represent that any license, either express or implied, is granted under any patent right, copyright, mask work right, or other intellectual property right relating to any combination, machine, or process in which TI components or services are used. Information published by TI regarding third-party products or services does not constitute a license to use such products or services or a warranty or endorsement thereof. Use of such information may require a license from a third party under the patents or other intellectual property of the third party, or a license from TI under the patents or other intellectual property of TI.

Reproduction of significant portions of TI information in TI data books or data sheets is permissible only if reproduction is without alteration and is accompanied by all associated warranties, conditions, limitations, and notices. TI is not responsible or liable for such altered documentation. Information of third parties may be subject to additional restrictions.

Resale of TI components or services with statements different from or beyond the parameters stated by TI for that component or service voids all express and any implied warranties for the associated TI component or service and is an unfair and deceptive business practice. TI is not responsible or liable for any such statements.

Buyer acknowledges and agrees that it is solely responsible for compliance with all legal, regulatory and safety-related requirements concerning its products, and any use of TI components in its applications, notwithstanding any applications-related information or support that may be provided by TI. Buyer represents and agrees that it has all the necessary expertise to create and implement safeguards which anticipate dangerous consequences of failures, monitor failures and their consequences, lessen the likelihood of failures that might cause harm and take appropriate remedial actions. Buyer will fully indemnify TI and its representatives against any damages arising out of the use of any TI components in safety-critical applications.

In some cases, TI components may be promoted specifically to facilitate safety-related applications. With such components, TI's goal is to help enable customers to design and create their own end-product solutions that meet applicable functional safety standards and requirements. Nonetheless, such components are subject to these terms.

No TI components are authorized for use in FDA Class III (or similar life-critical medical equipment) unless authorized officers of the parties have executed a special agreement specifically governing such use.

Only those TI components which TI has specifically designated as military grade or "enhanced plastic" are designed and intended for use in military/aerospace applications or environments. Buyer acknowledges and agrees that any military or aerospace use of TI components which have **not** been so designated is solely at the Buyer's risk, and that Buyer is solely responsible for compliance with all legal and regulatory requirements in connection with such use.

TI has specifically designated certain components as meeting ISO/TS16949 requirements, mainly for automotive use. In any case of use of non-designated products, TI will not be responsible for any failure to meet ISO/TS16949.

### Products

Audio	<a href="http://www.ti.com/audio">www.ti.com/audio</a>
Amplifiers	<a href="http://amplifier.ti.com">amplifier.ti.com</a>
Data Converters	<a href="http://dataconverter.ti.com">dataconverter.ti.com</a>
DLP® Products	<a href="http://www.dlp.com">www.dlp.com</a>
DSP	<a href="http://dsp.ti.com">dsp.ti.com</a>
Clocks and Timers	<a href="http://www.ti.com/clocks">www.ti.com/clocks</a>
Interface	<a href="http://interface.ti.com">interface.ti.com</a>
Logic	<a href="http://logic.ti.com">logic.ti.com</a>
Power Mgmt	<a href="http://power.ti.com">power.ti.com</a>
Microcontrollers	<a href="http://microcontroller.ti.com">microcontroller.ti.com</a>
RFID	<a href="http://www.ti-rfid.com">www.ti-rfid.com</a>
OMAP Applications Processors	<a href="http://www.ti.com/omap">www.ti.com/omap</a>
Wireless Connectivity	<a href="http://www.ti.com/wirelessconnectivity">www.ti.com/wirelessconnectivity</a>

### Applications

Automotive and Transportation	<a href="http://www.ti.com/automotive">www.ti.com/automotive</a>
Communications and Telecom	<a href="http://www.ti.com/communications">www.ti.com/communications</a>
Computers and Peripherals	<a href="http://www.ti.com/computers">www.ti.com/computers</a>
Consumer Electronics	<a href="http://www.ti.com/consumer-apps">www.ti.com/consumer-apps</a>
Energy and Lighting	<a href="http://www.ti.com/energy">www.ti.com/energy</a>
Industrial	<a href="http://www.ti.com/industrial">www.ti.com/industrial</a>
Medical	<a href="http://www.ti.com/medical">www.ti.com/medical</a>
Security	<a href="http://www.ti.com/security">www.ti.com/security</a>
Space, Avionics and Defense	<a href="http://www.ti.com/space-avionics-defense">www.ti.com/space-avionics-defense</a>
Video and Imaging	<a href="http://www.ti.com/video">www.ti.com/video</a>

### TI E2E Community

[e2e.ti.com](http://e2e.ti.com)