

Test Report: PMP41114

3.6kW, 54V, Single-Phase, AC-to-DC Rectifier Reference Design With all GaN Switches



Description

This reference design is a digitally controlled 3.6kW, 54V, single-phase, AC-to-DC rectifier with all GaN switches. This design is a demonstration for modular hardware system common redundant power supply (M-CRPS) with standard form factor. The input stage chooses a single-phase, totem-pole bridgeless power factor correction (PFC), and the output stage chooses a full-bridge, inductor-inductor-capacitor (FB LLC) converter with full-bridge synchronous rectifier (FB SR). The LLC stage efficiency achieved 98.5% at the half load, and the PFC stage efficiency achieved 98.92% at the half load.



Whole Board With Shell

Features

- System reference design for server power
- 3.6kW, 54V output with 185mm × 73.5mm × 40mm (including case)
- Higher than 80 plus titanium efficiency with all GaN switches
- Ultra-compact LLC module with PCB windings
- Fully functioning demonstration with Open Compute Project (OCP) M-CRPS standards

Applications

- [Rack and server power](#)
- [Telecom rectifiers](#)
- [Industrial AC-DC](#)

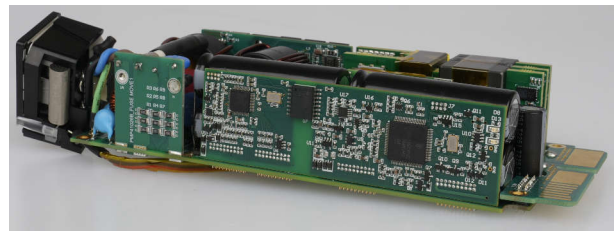

Right Angle of Board

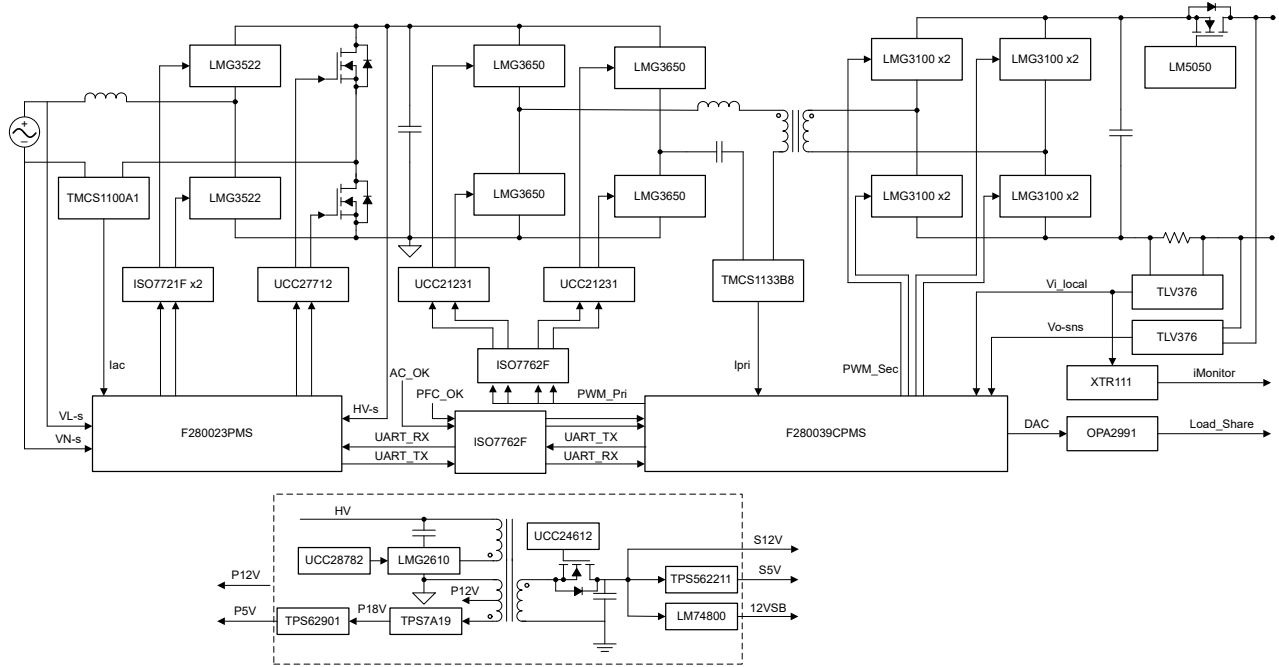

PMP41114 Detailed Block Diagram

1 Test Prerequisites

1.1 Voltage and Current Requirements

Table 1-1. Voltage and Current Requirements

PARAMETER	SPECIFICATIONS
Input Voltage	85VAC to 264VAC
Input Current	0A to 16A
Main Output Voltage	54VDC
Main Output Current	0A to 67A
Standby Output Voltage	12VDC
Standby Output Current	0A to 3A

1.2 Required Equipment

- Computer with Code Composer Studio™ and DigitalPower SDK installed
- Programmable AC power supply, 300V 20A
- Programmable DC power supply, 500V 15A
- Electronic load, 60V 120A
- Dual-channel isolated DC power supply, 12V, 3A
- AC power analyzer
- Oscilloscope (minimum 100MHz bandwidth)
- Current probe (minimum 100kHz bandwidth)
- Multichannel temperature tester

1.3 Considerations

All testing in this report is done on the LLC stage only, without the PFC stage and auxiliary power stage. TDG supported testing on the ferrite cores in the LLC module. The [PMP23338](#) tool page has information about the PFC stage. See also the [PMP23146](#) tool page for information about the auxiliary power stage. This design is still in development and can be updated in the future, please contact TI to get the latest design file for your development.

1.4 Dimensions

Board size: 159mm × 70mm × 37mm, (open frame without golden finger).

1.5 Test Setup

Figure 1-1 shows the test setup for the LLC stage.

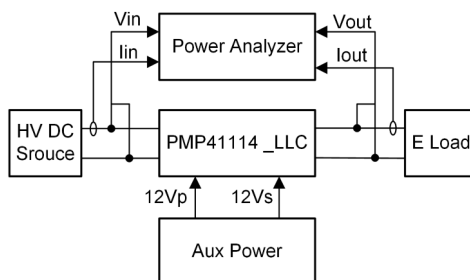

Figure 1-1. Test Setup

2 Testing and Results

2.1 Efficiency Graphs

The efficiency graph represented in [Figure 2-1](#) is tested with the ferrite core of TPG33B, the EC25 shape is used for primary resonant, and the PQ32 shape is used for the transformer.

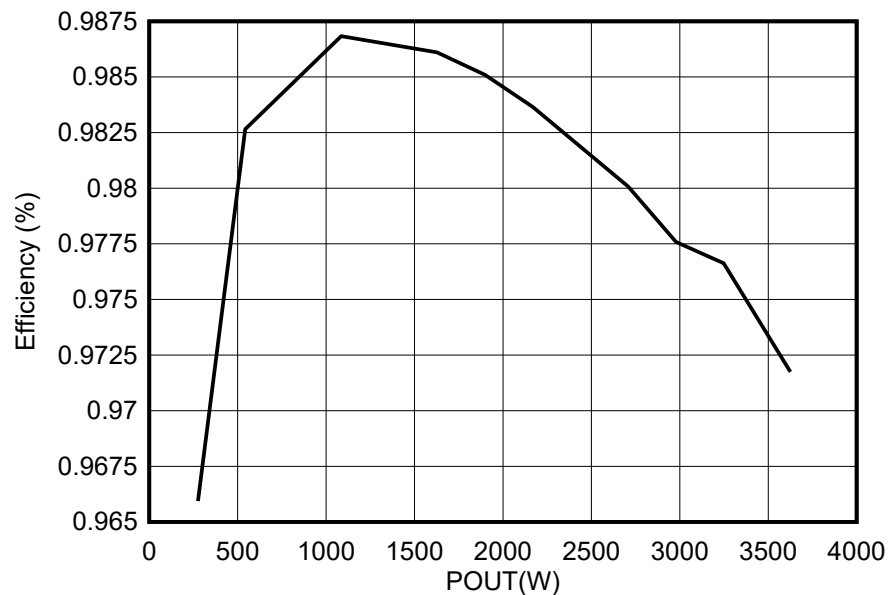

Figure 2-1. Efficiency Graph of LLC Stage

2.2 Efficiency Data

[Table 2-1](#) shows the efficiency data of LLC stage.

Table 2-1. Efficiency Data

V _{IN} (V)	I _{IN} (A)	V _{OUT} (V)	I _{OUT} (A)	P _{IN} (W)	P _{OUT} (W)	P _{LOSS} (W)	EFFICIENCY (%)
399.94	0.15857	54.27	1	63.42	54.27	9.15	85.57%
399.91	0.7128	55.069	5	285.06	275.35	9.71	96.59%
399.79	1.3812	54.261	10	552.19	542.61	9.58	98.27%
399.65	2.7511	54.25	20	1099.48	1085.00	14.48	98.68%
399.55	4.1295	54.234	30	1649.94	1627.02	22.92	98.61%
399.5	4.8225	54.225	35	1926.59	1897.88	28.71	98.51%
399.44	5.519	54.212	40	2204.51	2168.48	36.03	98.37%
399.32	6.923	54.188	50	2764.49	2709.40	55.09	98.01%
399.25	8.331	54.14	60	3326.15	3248.40	77.75	97.66%
399.15	9.348	54.117	67	3731.25	3625.84	105.42	97.17%

2.3 Thermal Images

Figure 2-2 shows the thermal image under full load.



Figure 2-2. Thermal Image

2.4 Bode Plots

Figure 2-3 through Figure 2-8 show the PMP41114 Bode plots.

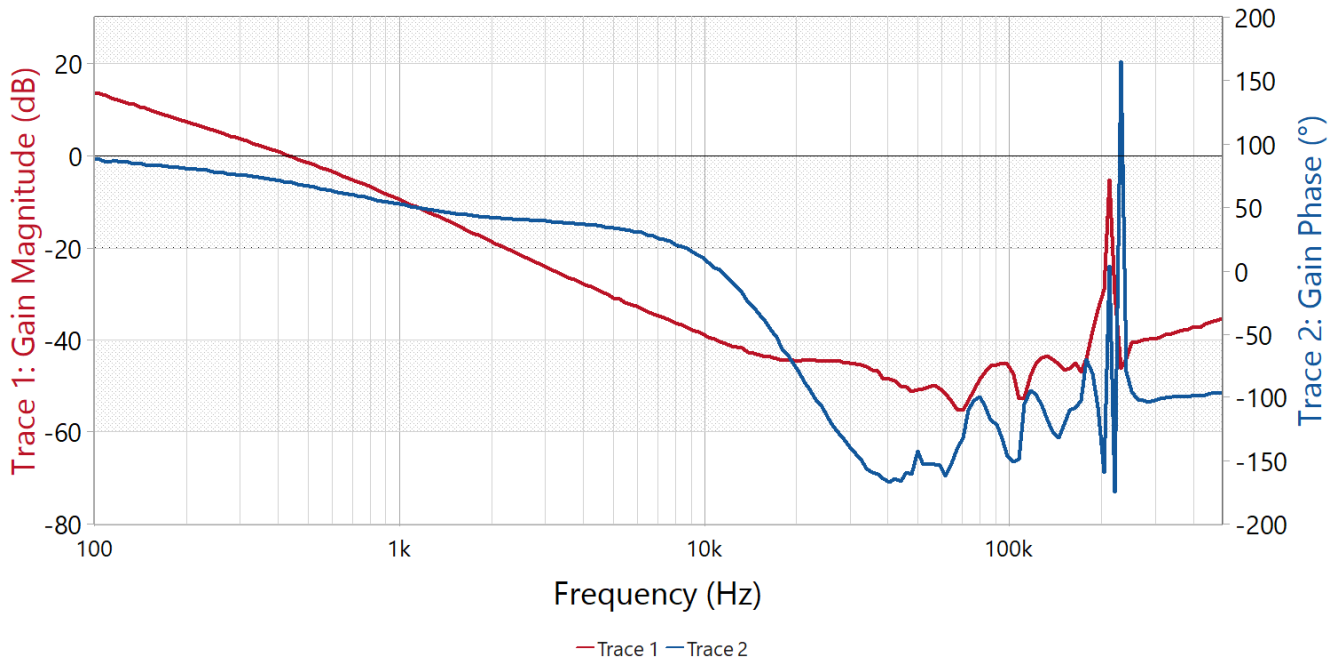

Figure 2-3. Bode Plot With 400V Input and 0A Load

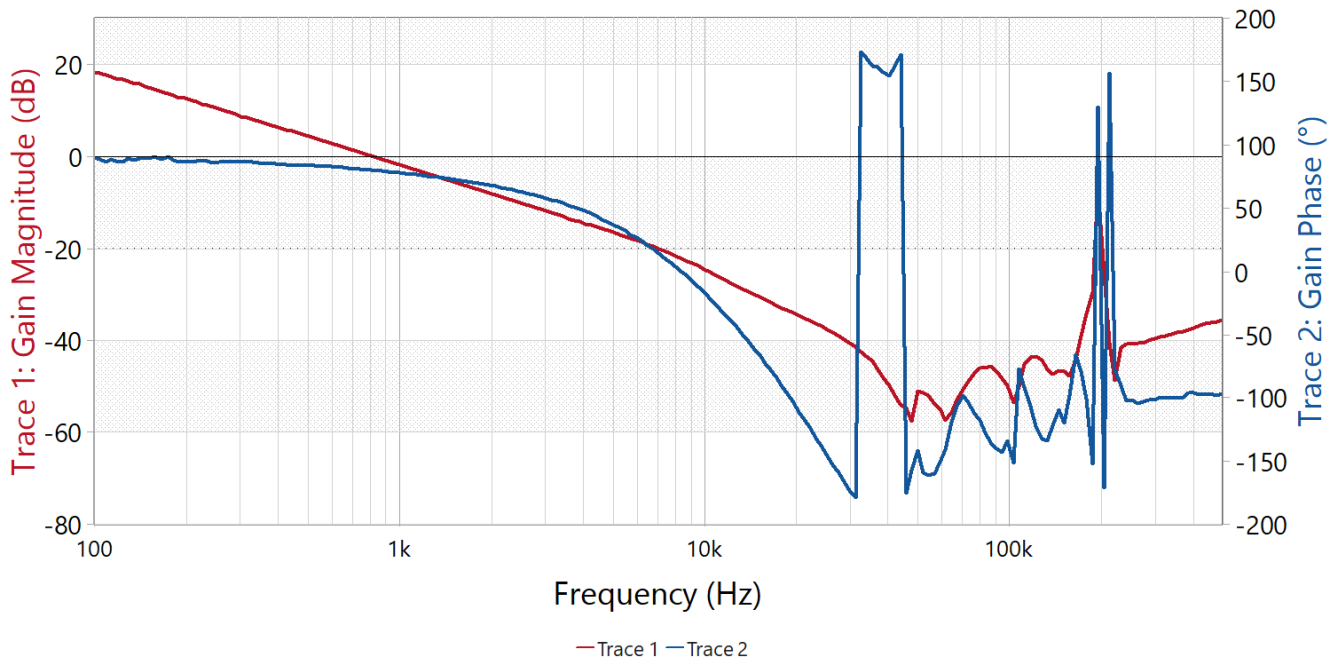

Figure 2-4. Bode Plot With 400V Input and 5A Load

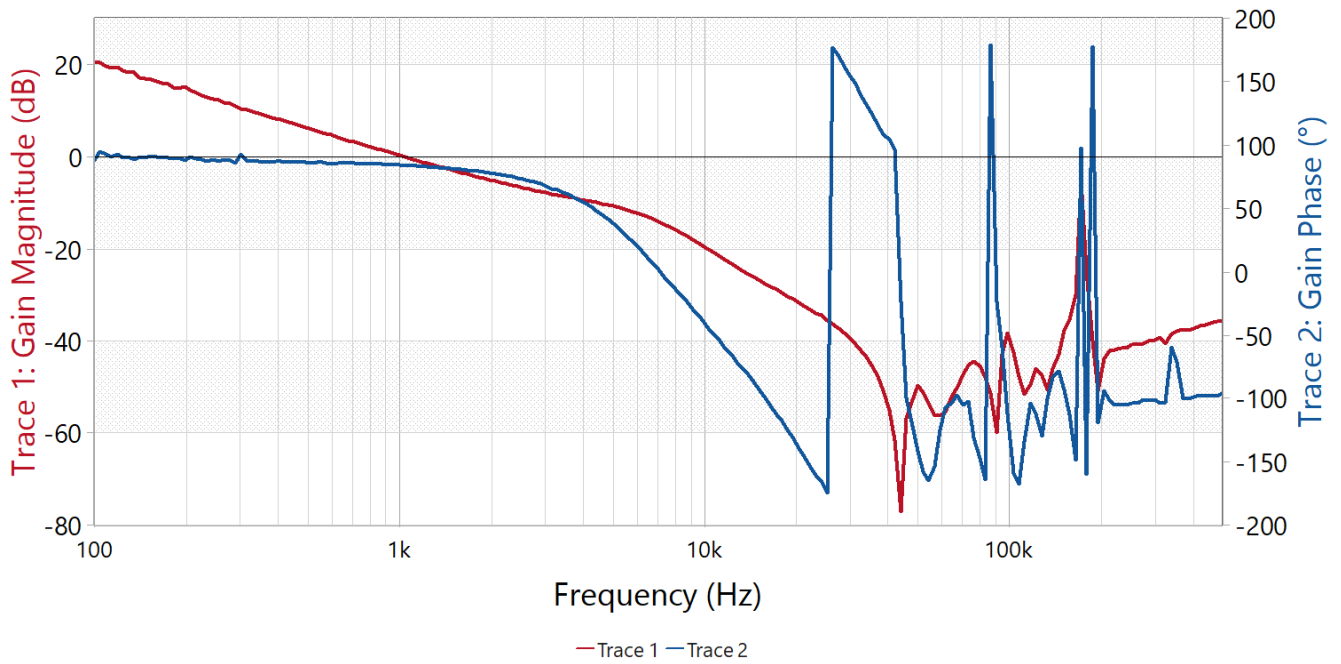

Figure 2-5. Bode Plot With 400V Input and 33.5A Load

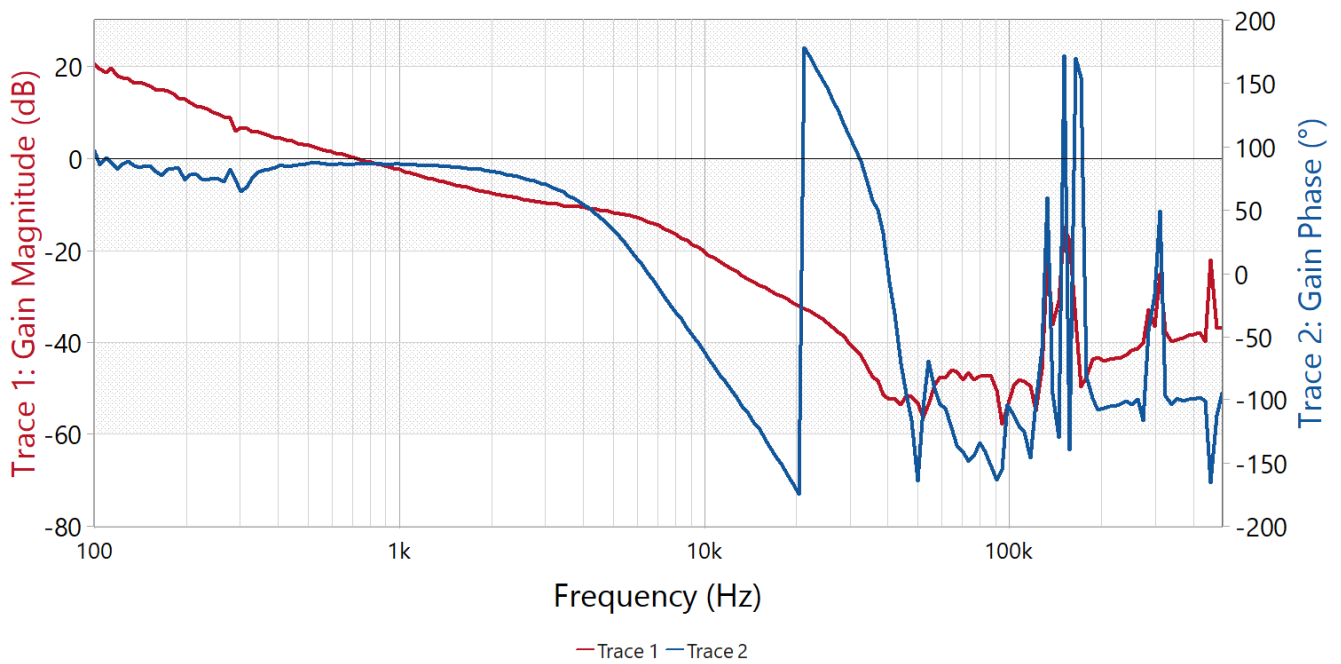

Figure 2-6. Bode Plot With 400V Input and 67A Load

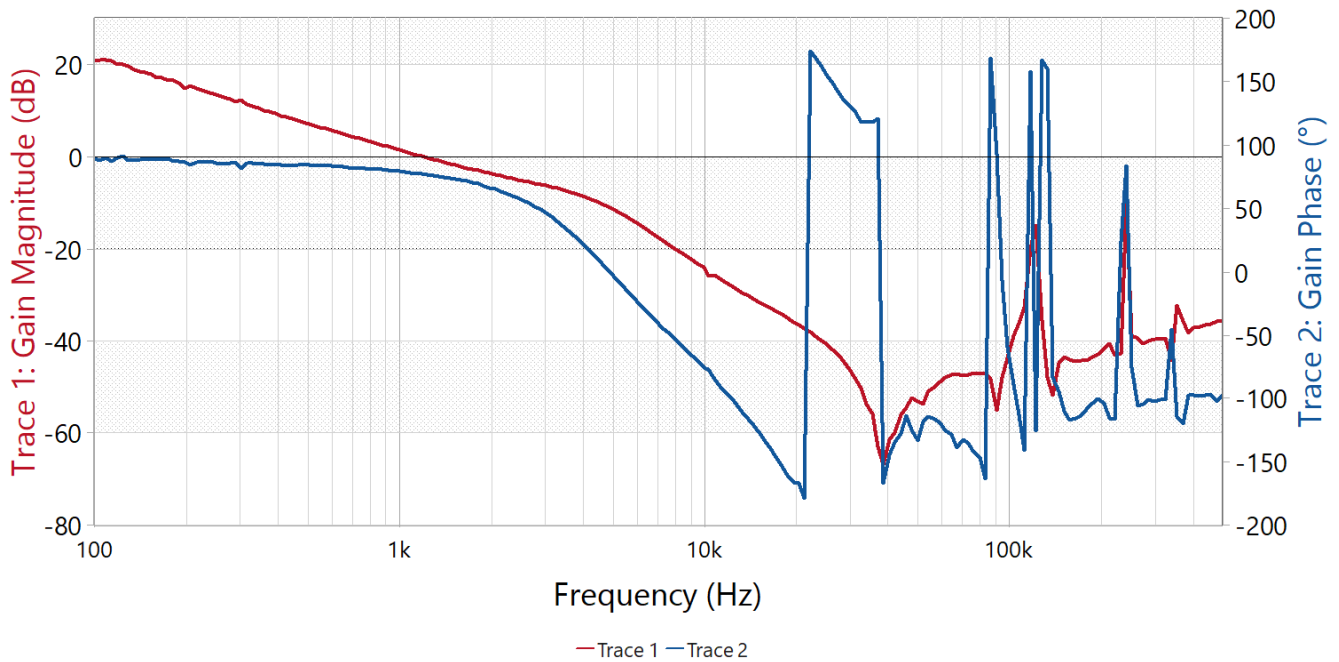

Figure 2-7. Bode Plot With 380V Input and 33.5A Load

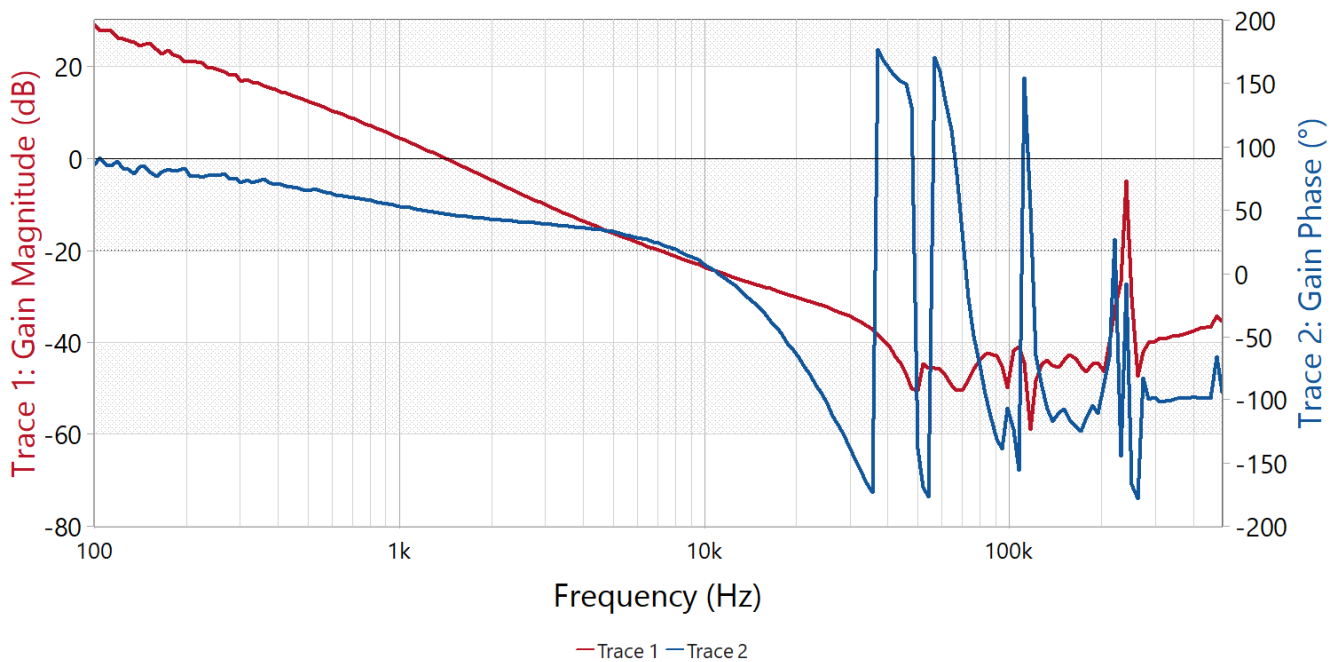

Figure 2-8. Bode Plot With 420V Input and 33.5A Load

3 Waveforms

3.1 Switching

Figure 3-1 through Figure 3-7 show the switching behavior. Each waveform reflects the following parameters:

- Ch 1 (dark blue) is load current
- Ch 2 (light blue) is switching voltage of one primary side half bridge
- Ch 3 (purple) is output voltage
- Ch 4 (green) is resonant current in primary side

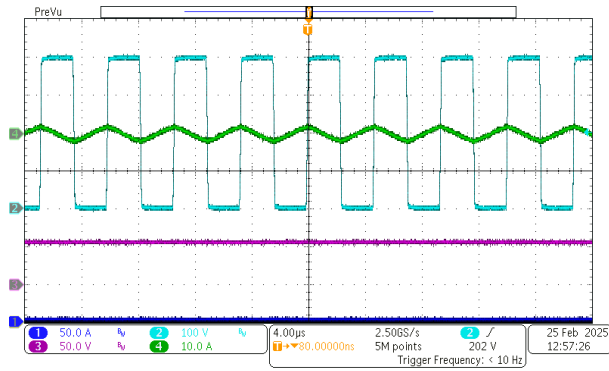

Figure 3-1. Switching Waveform Under 400V Input and No Load

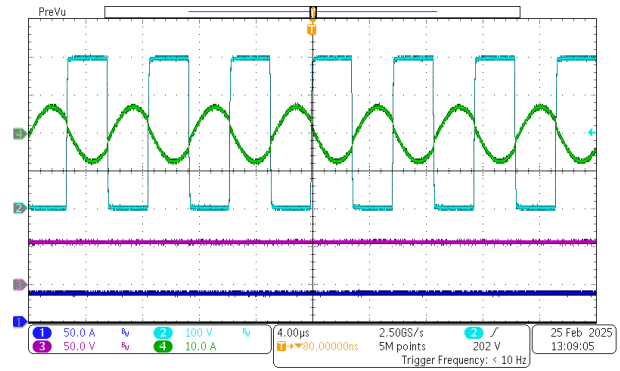

Figure 3-2. Switching Waveform Under 400V Input and 33.5A Load

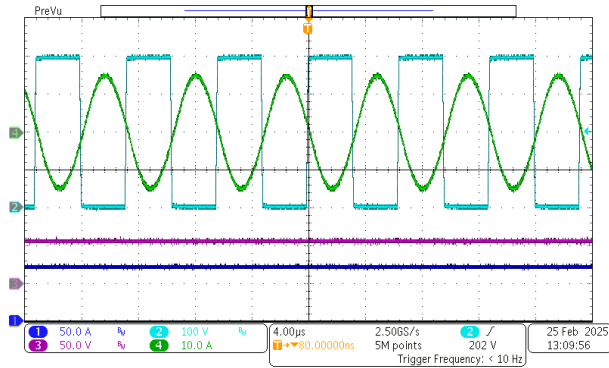

Figure 3-3. Switching Waveform Under 400V Input and 67A Load

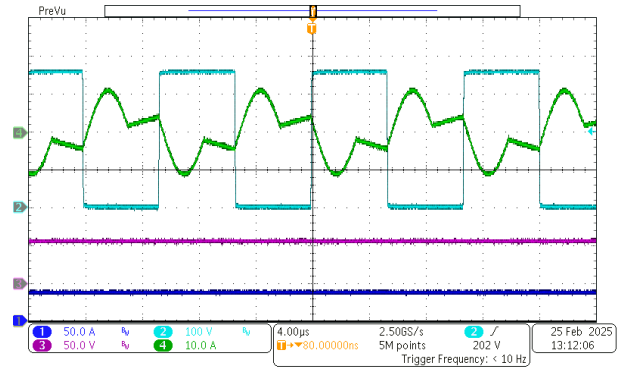

Figure 3-4. Switching Waveform Under 360V Input and 33.5A Load

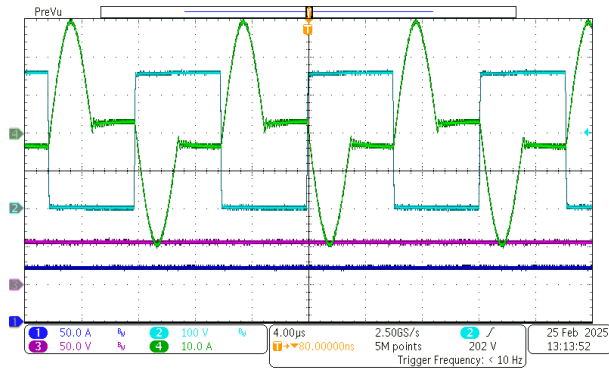

Figure 3-5. Switching Waveform Under 360V Input and 67A Load

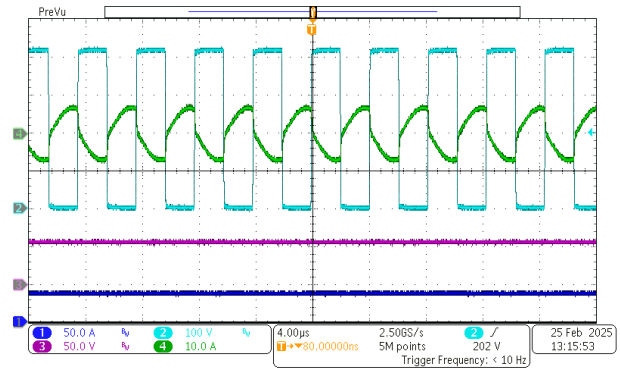

Figure 3-6. Switching Waveform Under 420V Input and 33.5A Load

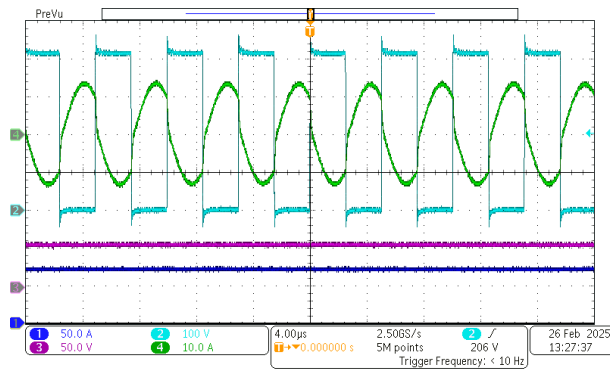

Figure 3-7. Switching Waveform Under 420V Input and 67A Load

3.2 Output Voltage Ripple

Figure 3-8 through Figure 3-10 show the output voltage ripple. Each waveform reflects the following parameters:

- Ch 3 (purple) is output voltage with ac coupled
- Ch 4 (green) is resonant current in primary side

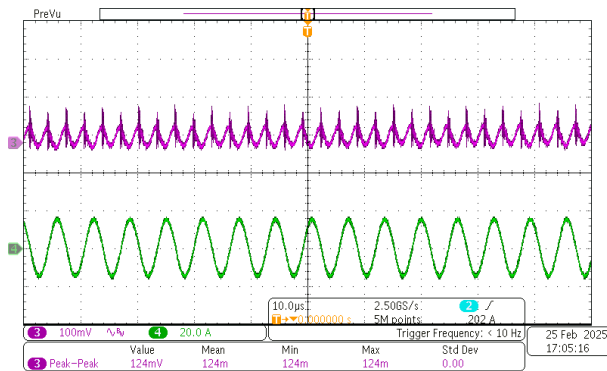

Figure 3-8. Output Voltage Ripple With 400V Input and 67A Load

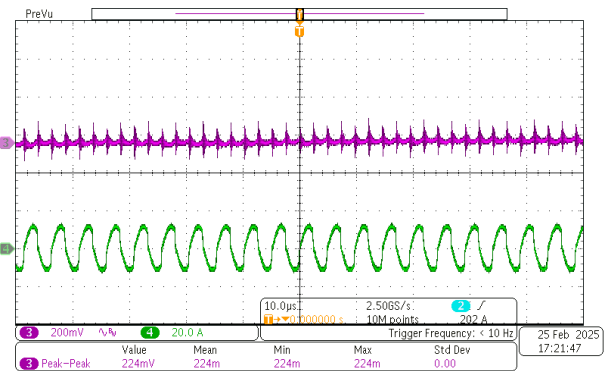

Figure 3-9. Output Voltage Ripple With 420V Input and 67A Load

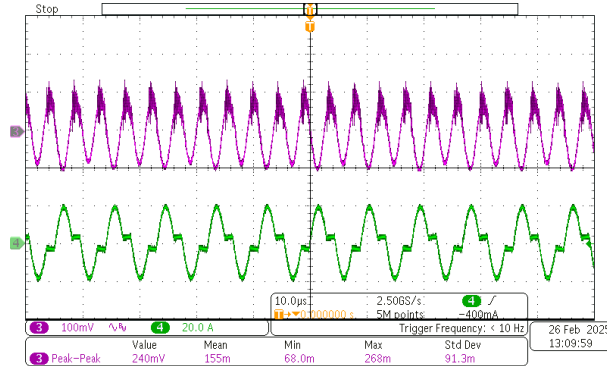

Figure 3-10. Output Voltage Ripple With 380V Input and 67A Load

3.3 Load Transients

Figure 3-11 through Figure 3-13 show the load transient response waveforms.

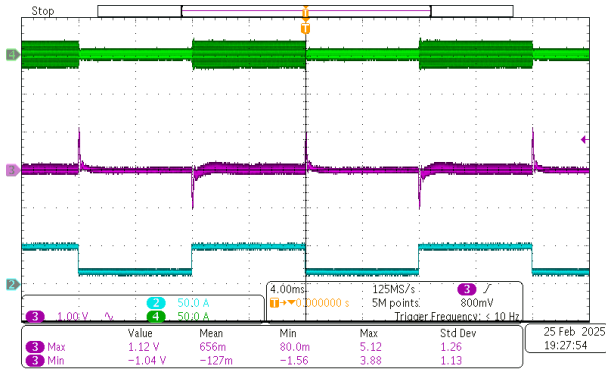

Figure 3-11. Load Transient: 380V Input, Load Step: 25% 8ms and 75% 8ms, 1A/μs

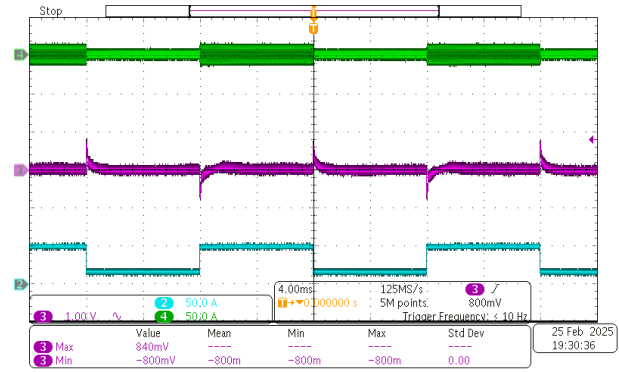

Figure 3-12. Load Transient: 400V Input, Load Step: 25% 8ms and 75% 8ms, 1A/μs

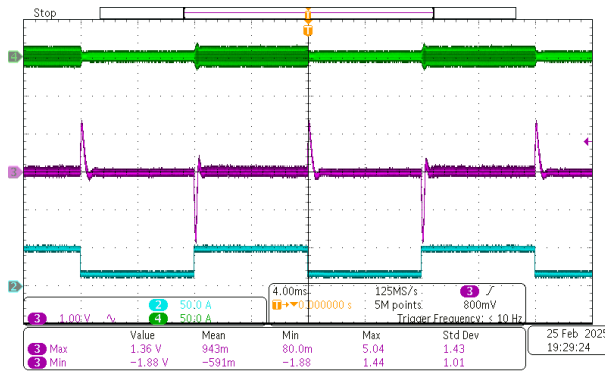

Figure 3-13. Load Transient: 420V Input, Load Step: 25% 8ms and 75% 8ms, 1A/μs

IMPORTANT NOTICE AND DISCLAIMER

TI PROVIDES TECHNICAL AND RELIABILITY DATA (INCLUDING DATA SHEETS), DESIGN RESOURCES (INCLUDING REFERENCE DESIGNS), APPLICATION OR OTHER DESIGN ADVICE, WEB TOOLS, SAFETY INFORMATION, AND OTHER RESOURCES "AS IS" AND WITH ALL FAULTS, AND DISCLAIMS ALL WARRANTIES, EXPRESS AND IMPLIED, INCLUDING WITHOUT LIMITATION ANY IMPLIED WARRANTIES OF MERCHANTABILITY, FITNESS FOR A PARTICULAR PURPOSE OR NON-INFRINGEMENT OF THIRD PARTY INTELLECTUAL PROPERTY RIGHTS.

These resources are intended for skilled developers designing with TI products. You are solely responsible for (1) selecting the appropriate TI products for your application, (2) designing, validating and testing your application, and (3) ensuring your application meets applicable standards, and any other safety, security, regulatory or other requirements.

These resources are subject to change without notice. TI grants you permission to use these resources only for development of an application that uses the TI products described in the resource. Other reproduction and display of these resources is prohibited. No license is granted to any other TI intellectual property right or to any third party intellectual property right. TI disclaims responsibility for, and you will fully indemnify TI and its representatives against, any claims, damages, costs, losses, and liabilities arising out of your use of these resources.

TI's products are provided subject to [TI's Terms of Sale](#) or other applicable terms available either on [ti.com](https://www.ti.com) or provided in conjunction with such TI products. TI's provision of these resources does not expand or otherwise alter TI's applicable warranties or warranty disclaimers for TI products.

TI objects to and rejects any additional or different terms you may have proposed.

Mailing Address: Texas Instruments, Post Office Box 655303, Dallas, Texas 75265

Copyright © 2025, Texas Instruments Incorporated