

# **UC1825B-SP total ionizing dose (TID) radiation report**

---



---



---

## **ABSTRACT**

This report discusses the results of the Total Ionizing Dose (TID) testing for the QML Class V certified Texas Instruments (TI) UC1825B-SP (596R876806VYC).

The study helps determine the TID effects under low dose rate (LDR) up to 100 krad(Si). The results show that all samples are fully functional after being exposed up to 100 krad(Si).

---

## **Contents**

1	Device Information.....	2
2	Total Dose Test Setup .....	3
3	TID Characterization Results.....	6
4	Applicable and Reference Documents.....	7
Appendix A	LDR TID Report.....	8

## **List of Figures**

1	Device Used in Exposure.....	3
2	Bias Diagram Used in TID Exposure.....	4

## **List of Tables**

1	Device and Exposure Details .....	2
2	LDR = 100 mrad (Si)/sec Device and Exposure Information .....	5
3	UC1825B-SP Spec Table.....	6

## **Trademarks**

All trademarks are the property of their respective owners.

## 1 Device Information

### 1.1 Product Description

The UC1825B-SP is a high-speed PWM controller and designed to use in either current-mode or voltage-mode system. Particular care is given to minimizing propagation delays through the comparators and logic circuitry while maximizing bandwidth and slew rate of the error amplifier.

The UC1825B-SP features totem pole outputs designed to source and sink high peak currents from capacitive loads.

The UC1825B-SP operates from supply of 10 V to 30 V, with low start up current of 1.1 mA. The devices are specified over the extended operating temperature range of  $-55^{\circ}\text{C}$  to  $125^{\circ}\text{C}$  and are offered in a 16-pin CFP package.

### 1.2 Device Details

Table 1 lists the device information used in the initial TID LDR characterization.

**Table 1. Device and Exposure Details**

TID LDR Details: Up to 100 krad(Si)	
TI Device Number	UC1825B-SP (5962R8768106VYC)
Package	16-pin Ceramic Flatpack HKT
Technology	Bipolar Process (JI)
Quantity Tested	62
Die Lot Number	8068289SHE
A/T Lot Number / Date Code	8005223MMT / 1827B
Lot Accept/Reject	Devices functional up to 100 krad(Si)
LDR Radiation Facility	RAD/Aeroflex in Colorado Springs, Colorado
LDR Dose Level	3 krad(Si), 10 krad(Si), 30 krad(Si), 50 krad(Si), 100 krad(Si)
LDR Dose Rate	0.01 rad(Si)/s
LDR Radiation Source	$^{60}\text{Co}$ gamma cell
Irradiation Temperature	Ambient, room temperature



**Figure 1. Device Used in Exposure**

## **2 Total Dose Test Setup**

### **2.1 Test Overview**

The UC1825B-SP is tested according to MIL-STD-883J, Test Method 1019.9. For this testing, Condition D is used. For this test, the product is irradiated up to the rated radiation level and then put through full electrical parametric testing on the production Automated Test Equipment (ATE). The device is functional through the testing and passed all parametric tests (within guard bands) of the Standard Microcircuit Drawing (SMD) electrical specification limits.

### **2.2 Test Description and Facilities**

The UC1825B-SP LDR exposure is performed on biased and unbiased devices in a  $^{60}\text{Co}$  gamma cell under a 10-mrad(Si)/s exposure rate. The dose rate of the irradiator used in the exposure ranges from < 10 mrad (Si)/s to a maximum of approximately 65 rad(Si)/s, determined by the distance from the source. For the LDR (10 mrad(Si)/s) exposure, the test box is positioned approximately 2 m from the source. The exposure boards are housed in a lead-aluminum box (as specified in MIL-STD-883 TM 1019.9) to harden the gamma spectrum and minimize dose enhancement effects. The irradiator calibration is maintained by Logmire Laboratories using Thermoluminescence Dosimeters (TLDs) traceable to the National Institute of Standards and Technology (NIST) and the dosimetry is verified using TLDs prior to the radiation exposures. After exposure, the devices are returned to the TI Dallas facility for a full post radiation electrical evaluation using TI production Automated Test Equipment (ATE). ATE guard band test limits are set within SMD electrical limits to ensure a minimum Cpk and test error margin based on initial qualification and characterization data.

## 2.3 Test Setup Details

The devices under LDR exposure were tested in both biased and unbiased conditions as described in the following two sections.

### 2.3.1 Unbiased

For the unbiased LDR conditions, the exposure was performed with all pins grounded.

### 2.3.2 Biased

Figure 2 depicts the bias diagram used in biased LDR testing.

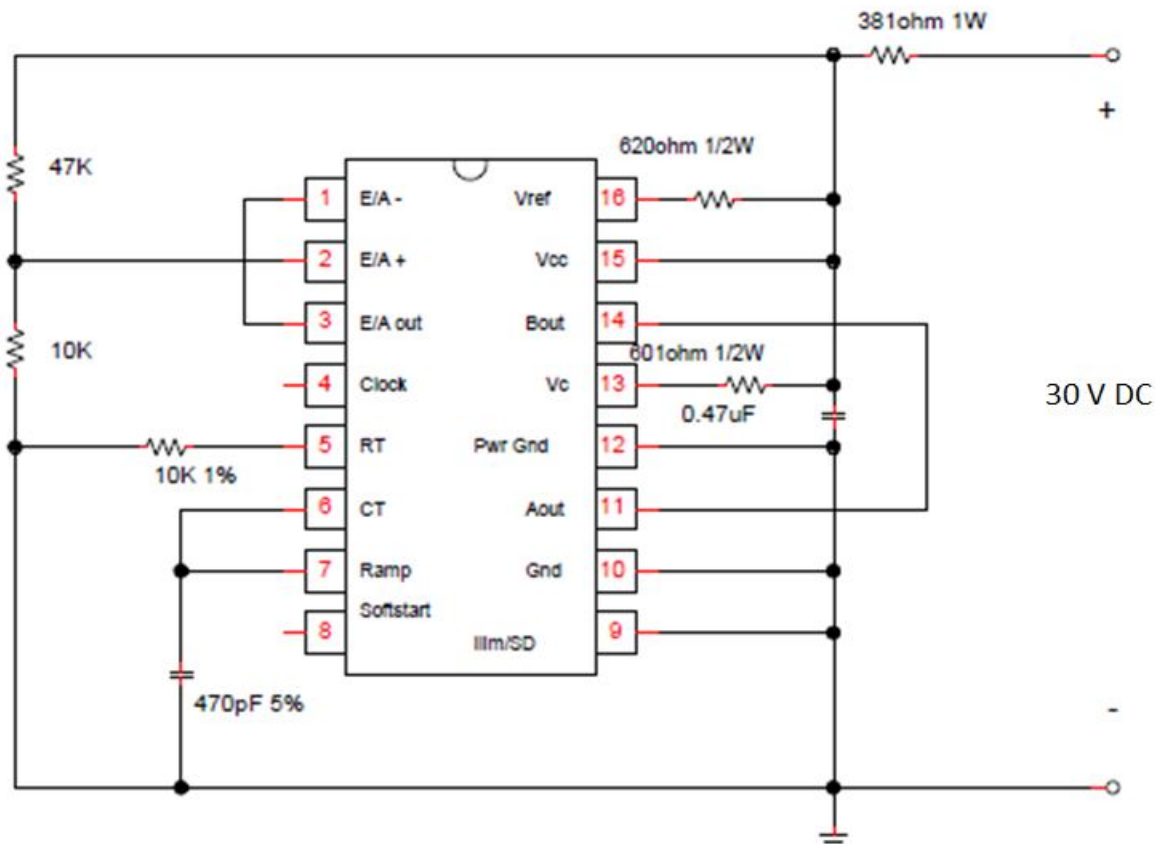

Figure 2. Bias Diagram Used in TID Exposure

## 2.4 Test Configuration and Conditions

A step-stress (3 krad, 10 krad, 30 krad, and 45 krad) test method is used to determine the TID hardness level. That is, after a predetermined TID level is reached, an electrical test is performed on a given sample of parts to verify that the units are within specified SMD electrical test limits. MIL-STD-883, Test Method 1019.9, Condition D is used in this case. If this passes, then the wafer lot can be certified as an RHA wafer lot.

Table 2 lists the samples used during the RHA characterization.

**Table 2. LDR = 100 mrad (Si)/sec Device and Exposure Information**

TOTAL SAMPLES: 10 PER DOSE RATE (5 BIASED + 5 UNBIASED)				
WAFER 1 - UNIT NUMBER				
3 krad (Si)	10 krad (Si)	30 krad (Si)	50 krad (Si)	100 krad (Si)
Biased	Biased	Biased	Biased	Biased
N/A	173, 176, 179, 180, 181	182, 183, 184, 185, 186	187, 192, 193, 195, 196	210, 211, 214, 220, 228
3 krad (Si)	10 krad (Si)	30 krad (Si)	50 krad (Si)	100 krad (Si)
Unbiased	Unbiased	Unbiased	Unbiased	Unbiased
42, 43, 47, 50, 53	54, 55, 56, 57, 58	61, 62, 63, 65, 67	69, 70, 72, 73, 74	86, 87, 89, 91, 92, 93, 95, 97, 99, 100, 102, 103, 104, 106, 108, 109, 153, 154, 155, 156, 157, 158

### 3 TID Characterization Results

Devices are functional after being exposed to 100 krad(Si). Full results are listed in [Appendix A](#).

#### 3.1 Device Spec Table

[Table 3](#) lists the device data sheet along with the corresponding ATE test that accompanies it.

**Table 3. UC1825B-SP Spec Table**

PARAMETER	TEST CONDITION	SLUSDD5				TEST # OR NAME
<b>REFERENCE</b>						
Output voltage	T <sub>J</sub> = 25°C, I <sub>O</sub> = 1 mA	5.02	5.10	5.18	V	1015.2__VREF_15 V_1 mA
						1015.3__VREF_30 V_1 mA
						1015.4__VREF_15 V_10 mA
						1015.5__VREF_30 V_10 mA
Line regulation	10 V < VCC < 30 V		2	20	mV	1015.6__VREF_Line_Reg
Load regulation	1 mA < I <sub>O</sub> < 10 mA		5	20	mV	1015.7__VREF_Load_Reg
<b>OSCILLATOR SECTION</b>						
Initial accuracy	T <sub>J</sub> = 25°C	360	400	440	kHz	1020.1__Osc_Freq @ 15 V
						1020.1__Osc_Freq @ 30 V
<b>ERROR AMPLIFIER</b>						
Input offset voltage				10	mV	1025.1__Vio
<b>SOFT_START</b>						
Charge current	VSoftStart = 0.5 V	3	9	20	μA	1040.1__Charge Current
Discharge current	VSoftStart = 1 V	1			μA	1040.2__Discharge Current
<b>OUTPUT</b>						
Low-level output voltage	I <sub>OUT</sub> = 20 mA		.25	.40	V	1045.2__VOL(OUTA) @ 20 mA
						1045.4__VOL(OUTB) @ 20 mA
	I <sub>OUT</sub> = 200 mA		1.2	2.2	V	1045.3__VOL(OUTA) @ 200 mA
						1045.5__VOL(OUTB) @ 200 mA
High-level output voltage	I <sub>OUT</sub> = -20 mA	13.0	13.5		V	1045.8__VOH(OUTB) @ 20 mA
						1045.10__VOH(OUTA) @ 20 mA
	I <sub>OUT</sub> = -200 mA	12.0	13.0		V	1045.9__VOH(OUTB) @ 200 mA
						1045.11__VOH(OUTA) @ 200 mA
<b>UNDER-VOLTAGE LOCKOUT</b>						
Start threshold		8.8	9.2	9.6	V	1010.5__VV UVLO ON
UVLO hysteresis		0.4	0.8	1.2	V	1010.&__UVLO Hysteresis
<b>SUPPLY CURRENT SECTION</b>						
Startup current	VCC = 8 V		1.1	2.5	mA	1010.1__ICC @ 8 V
ICC	V <sub>INV</sub> = V <sub>Ramp</sub> = V <sub>LIM</sub> /SD = 0 V, V <sub>NI</sub> = 1 V		22	33	mA	1010.3__ICC @ 15 V

## **4 Applicable and Reference Documents**

### **4.1 Applicable Documents**

Texas Instruments, [Class-V, radiation hardened high-speed PWM controller data sheet](#)

### **4.2 Reference Documents**

Texas Instruments Total Ionizing Dose radiation (total dose) test procedure follows the standards put forth in MIL-STD-883 TM 1019. The document can be found at the DLA website.

## **LDR TID Report**

---

---

---

---



Delta Threshold 10.00%

TID Report  
5962R8768106VYC

TID Report  
5962R8768106VYC

1010.1 ICC @ 8V		
Test Site	Junkins	Junkins
Tester	FETS01	FETS01
Test Number	EF066700	EF066700
Unit	mA	mA
Max Limit	2.5	2.5
Min Limit	0.5	0.5

krad	Serial #	PRERLAT	POSTRLAT	Delta
3	42	1.253	1.261	-0.007
3	43	1.255	1.257	-0.002
3	47	1.264	1.263	0.000
3	50	1.267	1.266	0.000
3	53	1.219	1.220	-0.001
10	54	1.262	1.257	0.005
10	55	1.254	1.250	0.003
10	56	1.251	1.215	0.036
10	57	1.260	1.247	0.013
10	58	1.261	1.240	0.021
12	173	1.251	1.238	0.013
12	176	1.251	1.241	0.010
12	179	1.246	1.235	0.010
12	180	1.264	1.255	0.010
12	181	1.234	1.222	0.013
30	61	1.249	1.230	0.019
30	62	1.240	1.220	0.020
30	63	1.256	1.235	0.021
30	65	1.247	1.213	0.034
30	67	1.232	1.212	0.020
32	182	1.250	1.240	0.010
32	183	1.237	1.227	0.009
32	184	1.250	1.217	0.033
32	185	1.225	1.216	0.009
32	186	1.237	1.217	0.020
50	69	1.242	1.182	0.060
50	70	1.257	1.206	0.051
50	72	1.247	1.216	0.031
50	73	1.253	1.215	0.039
50	74	1.224	1.182	0.042
52	187	1.223	1.193	0.030
52	192	1.246	1.195	0.051
52	193	1.251	1.178	0.073
52	195	1.219	1.149	0.071
52	196	1.252	1.192	0.060
100	86	1.249	1.183	0.066
100	87	1.220	1.150	0.070
100	89	1.253	1.181	0.072
100	91	1.232	1.158	0.073
100	92	1.224	1.153	0.072
100	93	1.230	1.159	0.070
100	95	1.224	1.166	0.059
100	97	1.252	1.175	0.077
100	99	1.242	1.178	0.063
100	100	1.221	1.165	0.056
100	102	1.248	1.185	0.063
100	103	1.256	1.169	0.087
100	104	1.250	1.164	0.087
100	106	1.251	1.182	0.069
100	108	1.231	1.171	0.060
100	109	1.260	1.193	0.067
100	153	1.253	1.170	0.083
100	154	1.230	1.166	0.063

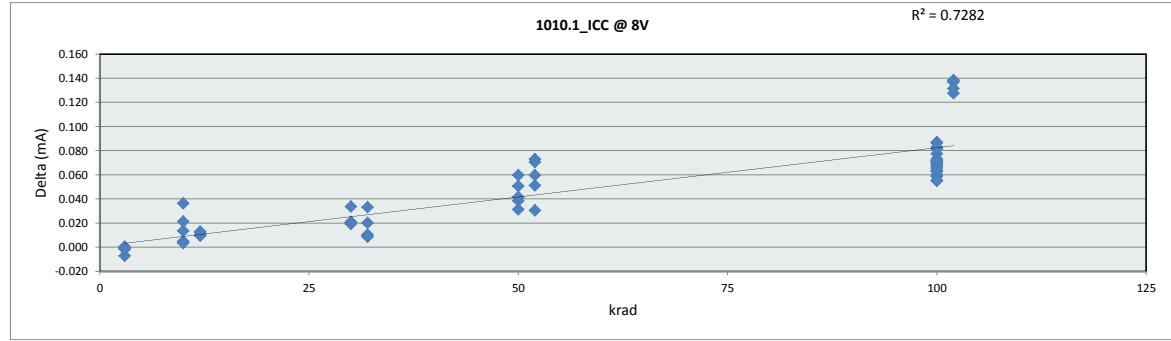

1010.1 ICC @ 8V		
Test Site	Junkins	Junkins
Tester	FETS01	FETS01
Test Number	EF066700	EF066700
Max Limit	2.5	mA
Min Limit	0.5	mA

krad	3(unbias)	10 (unbias)	10 (bias)	30 (unbias)	30 (bias)	50 (unbias)	50 (bias)	100 (unbias)	100 (bias)
LL	0.500	0.500	0.500	0.500	0.500	0.500	0.500	0.500	0.500
Min	1.220	1.215	1.222	1.212	1.216	1.182	1.149	1.150	1.090
Average	1.253	1.242	1.238	1.222	1.223	1.200	1.181	1.172	1.114
Max	1.267	1.257	1.255	1.235	1.240	1.216	1.195	1.193	1.126
UL	2.500	2.500	2.500	2.500	2.500	2.500	2.500	2.500	2.500

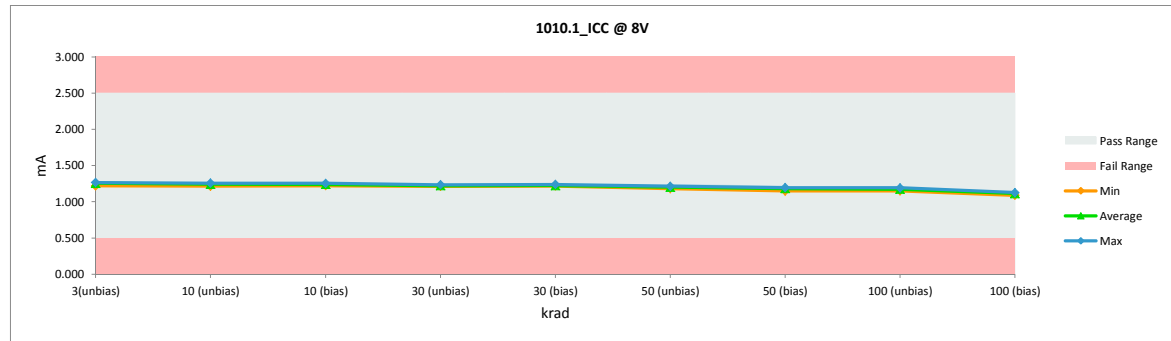

TID Report  
5962R8768106VYC

100	155	1.242	1.161	0.081
100	156	1.250	1.184	0.066
100	157	1.247	1.175	0.072
100	158	1.248	1.193	0.055
102	210	1.254	1.126	0.128
102	211	1.254	1.117	0.137
102	214	1.228	1.090	0.138
102	220	1.264	1.126	0.138
102	228	1.241	1.110	0.132
	Max	1.267	1.266	0.138
	Average	1.245	1.196	0.049
	Min	1.219	1.090	-0.007
	Std Dev	0.013	0.041	0.037

TID Report  
5962R8768106VYC

1010.3 ICC @ 15V		
Test Site	Junkins	Junkins
Tester	FETS01	FETS01
Test Number	EF066700	EF066700
Unit	mA	mA
Max Limit	33	33
Min Limit	4	4

krad	Serial #	PRERLAT	POSTRLAT	Delta
3	42	27.033	27.064	-0.031
3	43	27.237	27.235	0.002
3	47	27.131	27.103	0.028
3	50	27.213	27.203	0.009
3	53	26.773	26.763	0.010
10	54	27.098	27.058	0.040
10	55	27.133	27.097	0.036
10	56	27.058	26.658	0.400
10	57	27.216	27.009	0.207
10	58	27.012	26.790	0.222
12	173	27.199	27.131	0.069
12	176	27.020	27.007	0.013
12	179	27.140	27.130	0.010
12	180	27.005	27.007	-0.002
12	181	26.905	26.860	0.045
30	61	26.984	26.853	0.131
30	62	26.928	26.795	0.133
30	63	26.999	26.859	0.139
30	65	27.000	26.738	0.261
30	67	26.897	26.761	0.136
32	182	27.103	27.232	-0.129
32	183	26.883	27.047	-0.163
32	184	27.076	27.003	0.073
32	185	26.889	27.036	-0.147
32	186	26.949	27.014	-0.066
50	69	27.040	26.675	0.366
50	70	26.814	26.499	0.316
50	72	27.083	26.860	0.223
50	73	27.071	26.792	0.279
50	74	26.784	26.477	0.307
52	187	26.916	26.924	-0.008
52	192	27.039	26.988	0.052
52	193	27.061	26.701	0.360
52	195	26.819	26.468	0.352
52	196	26.796	26.564	0.232
100	86	27.267	26.822	0.446
100	87	26.781	26.341	0.440
100	89	26.903	26.485	0.417
100	91	26.702	26.391	0.311
100	92	26.735	26.260	0.476
100	93	26.883	26.479	0.404
100	95	26.782	26.389	0.392
100	97	27.129	26.633	0.497
100	99	26.985	26.563	0.421
100	100	26.944	26.575	0.370
100	102	27.067	26.648	0.419
100	103	26.923	26.517	0.406
100	104	26.883	26.507	0.377
100	106	27.037	26.598	0.439
100	108	26.841	26.450	0.391
100	109	27.315	26.884	0.430
100	153	27.066	26.653	0.414
100	154	26.686	26.278	0.409

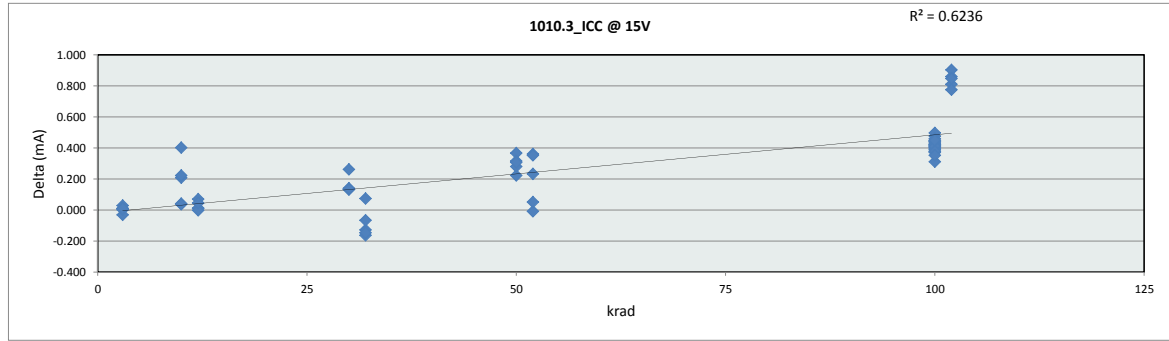

1010.3 ICC @ 15V		
Test Site	Junkins	Junkins
Tester	FETS01	FETS01
Test Number	EF066700	EF066700
Max Limit	33	mA
Min Limit	4	mA

krad	3(unbias)	10 (unbias)	10 (bias)	30 (unbias)	30 (bias)	50 (unbias)	50 (bias)	100 (unbias)	100 (bias)
LL	4.000	4.000	4.000	4.000	4.000	4.000	4.000	4.000	4.000
Min	26.763	26.658	26.860	26.738	27.003	26.477	26.468	26.260	25.904
Average	27.074	26.922	27.027	26.801	27.066	26.660	26.729	26.536	26.100
Max	27.235	27.097	27.131	26.859	27.232	26.860	26.988	26.884	26.287
UL	33.000	33.000	33.000	33.000	33.000	33.000	33.000	33.000	33.000

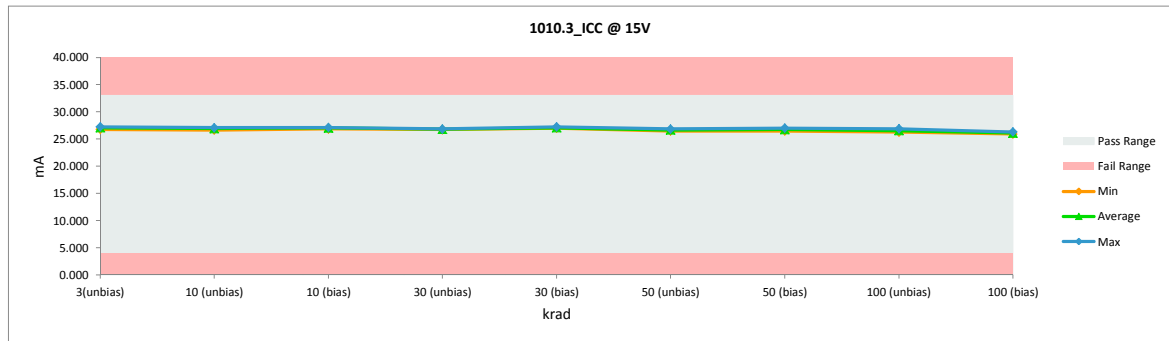

TID Report  
5962R8768106VYC

100	155	26.828	26.369	0.459
100	156	26.990	26.611	0.379
100	157	27.072	26.622	0.449
100	158	27.076	26.724	0.352
102	210	26.714	25.904	0.810
102	211	27.125	26.265	0.860
102	214	26.845	25.943	0.902
102	220	27.133	26.287	0.847
102	228	26.876	26.102	0.774
	Max	27.315	27.235	0.902
	Average	26.982	26.705	0.277
	Min	26.686	25.904	-0.163
	Std Dev	0.149	0.313	0.250

TID Report  
5962R8768106VYC

1010.5_VCC UVLO ON		
Test Site	Junkins	Junkins
Tester	FETS01	FETS01
Test Number	EF066700	EF066700
Unit	V	V
Max Limit	9.6	9.6
Min Limit	8.8	8.8

krad	Serial #	PRERLAT	POSTRLAT	Delta
3	42	9.202	9.205	-0.002
3	43	9.202	9.202	0.000
3	47	9.205	9.202	0.002
3	50	9.202	9.202	0.000
3	53	9.200	9.200	0.000
10	54	9.209	9.205	0.005
10	55	9.193	9.191	0.002
10	56	9.191	9.186	0.005
10	57	9.200	9.188	0.012
10	58	9.212	9.205	0.007
12	173	9.195	9.193	0.002
12	176	9.195	9.198	-0.002
12	179	9.200	9.198	0.002
12	180	9.195	9.195	0.000
12	181	9.193	9.193	0.000
30	61	9.198	9.184	0.014
30	62	9.202	9.191	0.012
30	63	9.188	9.177	0.012
30	65	9.205	9.184	0.021
30	67	9.209	9.195	0.014
32	182	9.195	9.198	-0.002
32	183	9.188	9.186	0.002
32	184	9.212	9.195	0.016
32	185	9.200	9.200	0.000
32	186	9.202	9.193	0.009
50	69	9.214	9.172	0.042
50	70	9.209	9.174	0.035
50	72	9.202	9.184	0.019
50	73	9.186	9.165	0.021
50	74	9.202	9.179	0.023
52	187	9.198	9.184	0.014
52	192	9.205	9.172	0.033
52	193	9.195	9.160	0.035
52	195	9.200	9.167	0.033
52	196	9.195	9.167	0.028
100	86	9.205	9.162	0.042
100	87	9.207	9.160	0.047
100	89	9.200	9.148	0.051
100	91	9.200	9.151	0.049
100	92	9.186	9.139	0.047
100	93	9.202	9.155	0.047
100	95	9.209	9.174	0.035
100	97	9.200	9.148	0.051
100	99	9.200	9.162	0.037
100	100	9.195	9.158	0.037
100	102	9.205	9.165	0.040
100	103	9.209	9.144	0.066
100	104	9.214	9.151	0.063
100	106	9.205	9.162	0.042
100	108	9.198	9.158	0.040
100	109	9.209	9.167	0.042
100	153	9.205	9.141	0.063
100	154	9.198	9.155	0.042

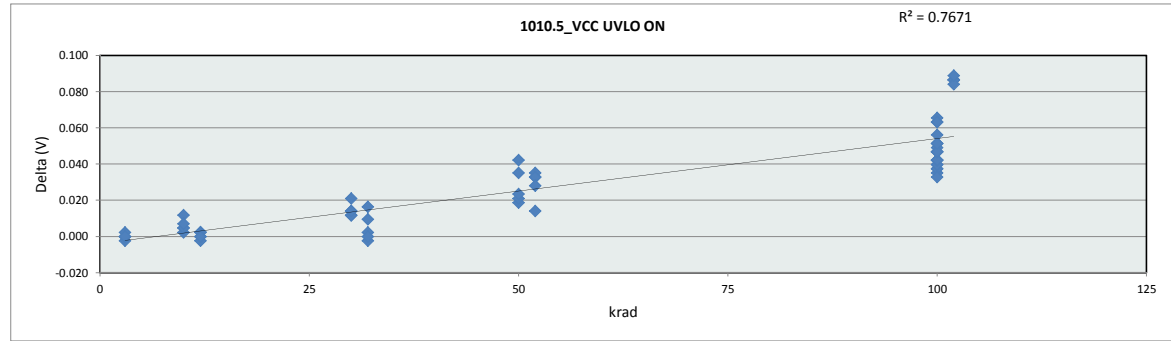

1010.5_VCC UVLO ON		
Test Site	Junkins	
Tester	FETS01	
Test Number	EF066700	
Max Limit	9.6	V
Min Limit	8.8	V

krad	3(unbias)	10 (unbias)	10 (bias)	30 (unbias)	30 (bias)	50 (unbias)	50 (bias)	100 (unbias)	100 (bias)
LL	8.800	8.800	8.800	8.800	8.800	8.800	8.800	8.800	8.800
Min	9.200	9.186	9.193	9.177	9.186	9.165	9.160	9.139	9.097
Average	9.202	9.195	9.195	9.186	9.194	9.175	9.170	9.155	9.108
Max	9.205	9.205	9.198	9.195	9.200	9.184	9.184	9.174	9.113
UL	9.600	9.600	9.600	9.600	9.600	9.600	9.600	9.600	9.600

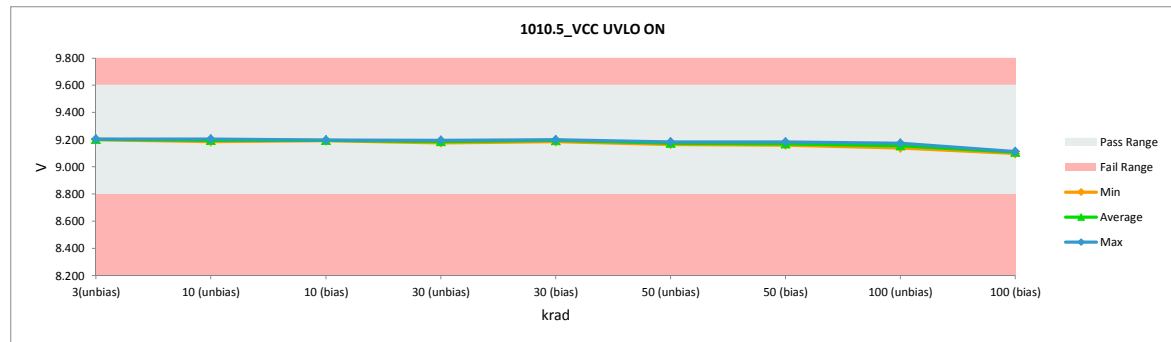

TID Report  
5962R8768106VYC

100	155	9.202	9.146	0.056
100	156	9.205	9.158	0.047
100	157	9.207	9.155	0.051
100	158	9.191	9.158	0.033
102	210	9.198	9.111	0.087
102	211	9.200	9.113	0.086
102	214	9.184	9.097	0.087
102	220	9.188	9.104	0.084
102	228	9.202	9.113	0.089
	Max	9.214	9.205	0.089
	Average	9.200	9.170	0.030
	Min	9.184	9.097	-0.002
	Std Dev	0.007	0.026	0.026

TID Report  
5962R8768106VYC

1010.7_UVLO Hysteresis		
Test Site	Junkins	Junkins
Tester	FETS01	FETS01
Test Number	EF066700	EF066700
Unit	V	V
Max Limit	1.2	1.2
Min Limit	0.4	0.4

krad	Serial #	PRERLAT	POSTRLAT	Delta
3	42	0.904	0.911	-0.007
3	43	0.889	0.894	-0.005
3	47	0.891	0.894	-0.002
3	50	0.889	0.894	-0.005
3	53	0.892	0.896	-0.005
10	54	0.896	0.896	0.000
10	55	0.889	0.892	-0.002
10	56	0.887	0.887	0.000
10	57	0.887	0.890	-0.003
10	58	0.889	0.891	-0.003
12	173	0.887	0.889	-0.002
12	176	0.887	0.889	-0.002
12	179	0.892	0.889	0.002
12	180	0.906	0.906	0.000
12	181	0.889	0.894	-0.005
30	61	0.894	0.890	0.004
30	62	0.889	0.882	0.007
30	63	0.885	0.878	0.007
30	65	0.887	0.875	0.011
30	67	0.891	0.882	0.009
32	182	0.887	0.894	-0.007
32	183	0.890	0.892	-0.002
32	184	0.894	0.882	0.012
32	185	0.887	0.892	-0.005
32	186	0.894	0.889	0.005
50	69	0.891	0.864	0.028
50	70	0.891	0.871	0.021
50	72	0.889	0.880	0.009
50	73	0.892	0.881	0.011
50	74	0.894	0.880	0.014
52	187	0.894	0.885	0.009
52	192	0.891	0.873	0.018
52	193	0.887	0.866	0.021
52	195	0.887	0.864	0.023
52	196	0.887	0.868	0.018
100	86	0.896	0.869	0.028
100	87	0.894	0.862	0.032
100	89	0.887	0.859	0.027
100	91	0.892	0.862	0.030
100	92	0.887	0.860	0.027
100	93	0.894	0.862	0.032
100	95	0.891	0.871	0.021
100	97	0.887	0.855	0.032
100	99	0.887	0.869	0.018
100	100	0.892	0.869	0.023
100	102	0.891	0.866	0.025
100	103	0.887	0.845	0.041
100	104	0.891	0.847	0.044
100	106	0.887	0.864	0.023
100	108	0.889	0.869	0.021
100	109	0.891	0.864	0.028
100	153	0.891	0.848	0.044
100	154	0.889	0.866	0.023

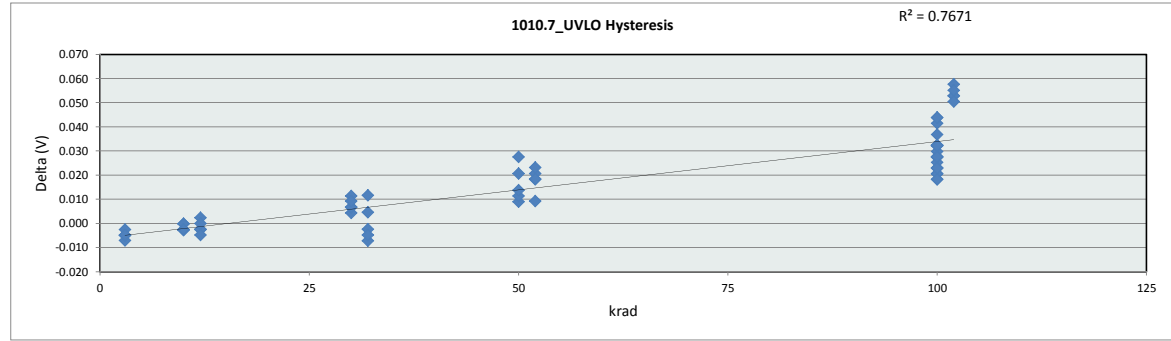

1010.7_UVLO Hysteresis		
Test Site	Junkins	
Tester	FETS01	
Test Number	EF066700	
Max Limit	1.2	V
Min Limit	0.4	V

krad	3(unbias)	10(unbias)	10(bias)	30(unbias)	30(bias)	50(unbias)	50(bias)	100(unbias)	100(bias)
LL	0.400	0.400	0.400	0.400	0.400	0.400	0.400	0.400	0.400
Min	0.894	0.887	0.889	0.875	0.882	0.864	0.864	0.845	0.832
Average	0.898	0.891	0.894	0.881	0.890	0.875	0.871	0.861	0.834
Max	0.911	0.896	0.906	0.890	0.894	0.881	0.885	0.871	0.839
UL	1.200	1.200	1.200	1.200	1.200	1.200	1.200	1.200	1.200

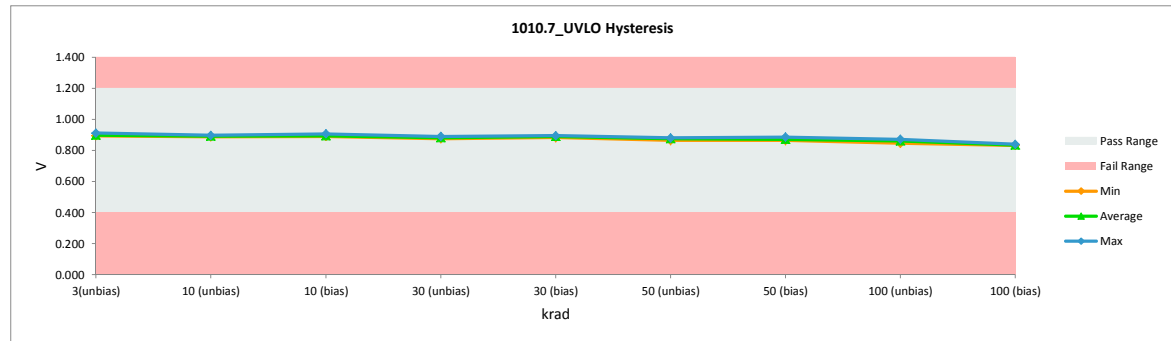



TID Report  
5962R8768106VYC

100	155	0.889	0.852	0.037
100	156	0.891	0.859	0.032
100	157	0.889	0.857	0.032
100	158	0.887	0.869	0.018
102	210	0.889	0.832	0.058
102	211	0.887	0.834	0.053
102	214	0.885	0.832	0.053
102	220	0.890	0.839	0.050
102	228	0.889	0.834	0.055
	Max	0.906	0.911	0.058
	Average	0.890	0.873	0.017
	Min	0.885	0.832	-0.007
	Std Dev	0.004	0.019	0.018

TID Report  
5962R8768106VYC

1015.2_VREF_15V_1mA		
Test Site	Junkins	Junkins
Tester	FETS01	FETS01
Test Number	EF066700	EF066700
Unit	V	V
Max Limit	5.176	5.176
Min Limit	5.024	5.024

krad	Serial #	PRERLAT	POSTRLAT	Delta
3	42	5.088	5.087	0.000
3	43	5.101	5.101	0.000
3	47	5.089	5.089	0.000
3	50	5.094	5.094	0.000
3	53	5.096	5.095	0.000
10	54	5.099	5.099	0.000
10	55	5.097	5.097	0.001
10	56	5.092	5.087	0.005
10	57	5.095	5.092	0.003
10	58	5.099	5.085	0.014
12	173	5.091	5.091	0.000
12	176	5.093	5.095	-0.002
12	179	5.109	5.111	-0.002
12	180	5.080	5.086	-0.006
12	181	5.088	5.091	-0.003
30	61	5.090	5.089	0.001
30	62	5.086	5.086	0.000
30	63	5.084	5.083	0.000
30	65	5.093	5.093	0.000
30	67	5.091	5.090	0.001
32	182	5.099	5.107	-0.008
32	183	5.093	5.100	-0.007
32	184	5.103	5.115	-0.012
32	185	5.109	5.117	-0.008
32	186	5.098	5.110	-0.013
50	69	5.096	5.103	-0.006
50	70	5.082	5.084	-0.003
50	72	5.094	5.093	0.000
50	73	5.095	5.095	0.000
50	74	5.095	5.095	0.000
52	187	5.115	5.124	-0.010
52	192	5.098	5.121	-0.023
52	193	5.098	5.111	-0.013
52	195	5.103	5.109	-0.006
52	196	5.095	5.109	-0.014
100	86	5.124	5.124	0.000
100	87	5.108	5.111	-0.003
100	89	5.099	5.110	-0.011
100	91	5.081	5.104	-0.023
100	92	5.083	5.083	0.000
100	93	5.101	5.109	-0.008
100	95	5.091	5.090	0.001
100	97	5.088	5.092	-0.004
100	99	5.091	5.091	0.001
100	100	5.115	5.116	-0.002
100	102	5.101	5.102	-0.001
100	103	5.088	5.115	-0.028
100	104	5.096	5.130	-0.034
100	106	5.096	5.097	-0.002
100	108	5.098	5.099	-0.001
100	109	5.099	5.102	-0.003
100	153	5.099	5.124	-0.025
100	154	5.085	5.086	-0.001

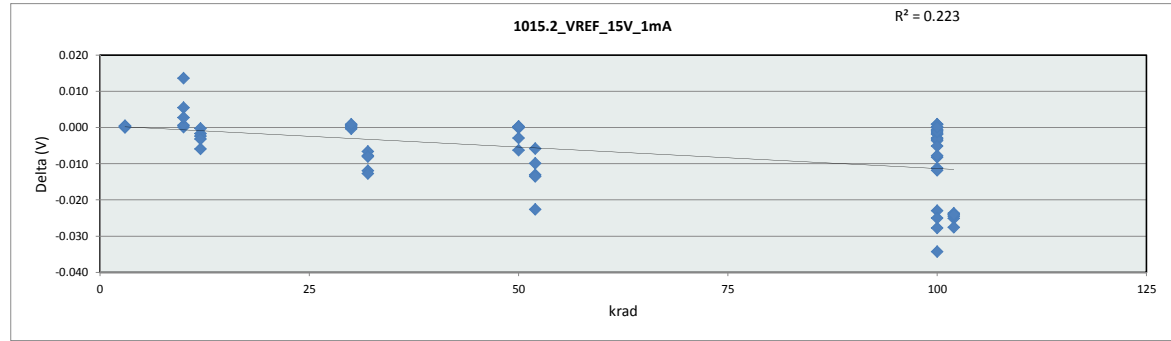

1015.2_VREF_15V_1mA		
Test Site	Junkins	Junkins
Tester	FETS01	FETS01
Test Number	EF066700	EF066700
Max Limit	5.176	V
Min Limit	5.024	V

krad	3(unbias)	10(unbias)	10(bias)	30(unbias)	30(bias)	50(unbias)	50(bias)	100(unbias)	100(bias)
LL	5.024	5.024	5.024	5.024	5.024	5.024	5.024	5.024	5.024
Min	5.087	5.085	5.086	5.083	5.100	5.085	5.109	5.084	5.099
Average	5.093	5.092	5.095	5.088	5.110	5.094	5.115	5.105	5.112
Max	5.101	5.099	5.111	5.093	5.118	5.103	5.124	5.130	5.119
UL	5.176	5.176	5.176	5.176	5.176	5.176	5.176	5.176	5.176

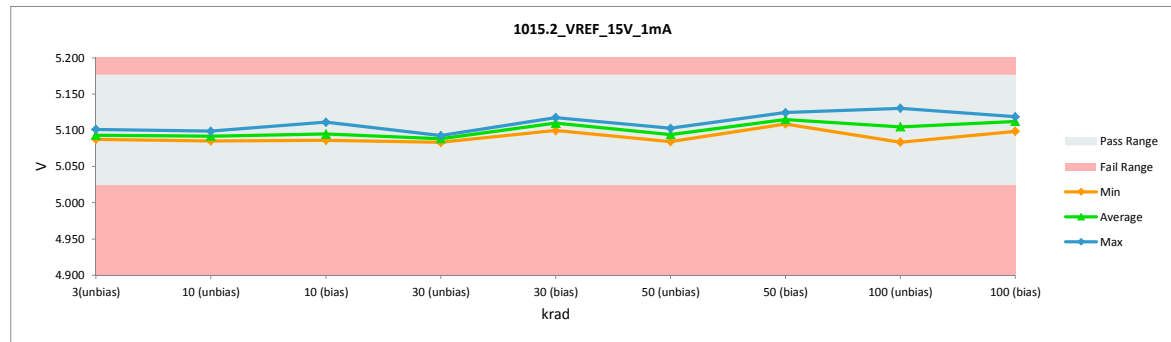

TID Report  
5962R8768106VYC

100	155	5.076	5.088	-0.012
100	156	5.102	5.110	-0.008
100	157	5.109	5.114	-0.005
100	158	5.103	5.103	0.000
102	210	5.075	5.099	-0.024
102	211	5.090	5.115	-0.025
102	214	5.094	5.119	-0.024
102	220	5.090	5.118	-0.028
102	228	5.088	5.112	-0.024
	Max	5.124	5.130	0.014
	Average	5.095	5.102	-0.006
	Min	5.075	5.083	-0.034
	Std Dev	0.009	0.012	0.010

# TID Report

## 5962R8768106VYC

1015.3_VREF_30V_1mA		
Test Site	Junkins	Junkins
Tester	FETS01	FETS01
Test Number	EF066700	EF066700
Unit	V	V
Max Limit	5.176	5.176
Min Limit	5.024	5.024

krad	Serial #	PRERLAT	POSTRLAT	Delta
3	42	5.086	5.085	0.000
3	43	5.099	5.099	0.000
3	47	5.086	5.085	0.000
3	50	5.092	5.092	0.000
3	53	5.094	5.093	0.000
10	54	5.095	5.095	0.000
10	55	5.095	5.095	0.001
10	56	5.090	5.085	0.005
10	57	5.092	5.090	0.003
10	58	5.096	5.083	0.012
12	173	5.089	5.089	0.000
12	176	5.091	5.092	-0.002
12	179	5.107	5.109	-0.003
12	180	5.078	5.084	-0.006
12	181	5.085	5.089	-0.003
30	61	5.088	5.088	0.000
30	62	5.083	5.084	-0.001
30	63	5.082	5.081	0.000
30	65	5.089	5.089	0.000
30	67	5.089	5.088	0.001
32	182	5.097	5.106	-0.009
32	183	5.090	5.098	-0.007
32	184	5.101	5.113	-0.013
32	185	5.107	5.116	-0.009
32	186	5.096	5.109	-0.013
50	69	5.095	5.102	-0.007
50	70	5.079	5.083	-0.003
50	72	5.092	5.091	0.000
50	73	5.093	5.094	0.000
50	74	5.093	5.093	0.000
52	187	5.112	5.123	-0.010
52	192	5.096	5.119	-0.023
52	193	5.095	5.109	-0.014
52	195	5.102	5.108	-0.006
52	196	5.093	5.107	-0.014
100	86	5.122	5.122	0.000
100	87	5.106	5.109	-0.003
100	89	5.097	5.109	-0.012
100	91	5.079	5.103	-0.024
100	92	5.082	5.082	-0.001
100	93	5.100	5.108	-0.009
100	95	5.089	5.089	0.000
100	97	5.086	5.091	-0.004
100	99	5.090	5.089	0.001
100	100	5.113	5.115	-0.002
100	102	5.099	5.100	-0.001
100	103	5.085	5.114	-0.029
100	104	5.094	5.129	-0.035
100	106	5.093	5.096	-0.002
100	108	5.096	5.097	-0.001
100	109	5.097	5.101	-0.003
100	153	5.097	5.123	-0.026
100	154	5.083	5.085	-0.002

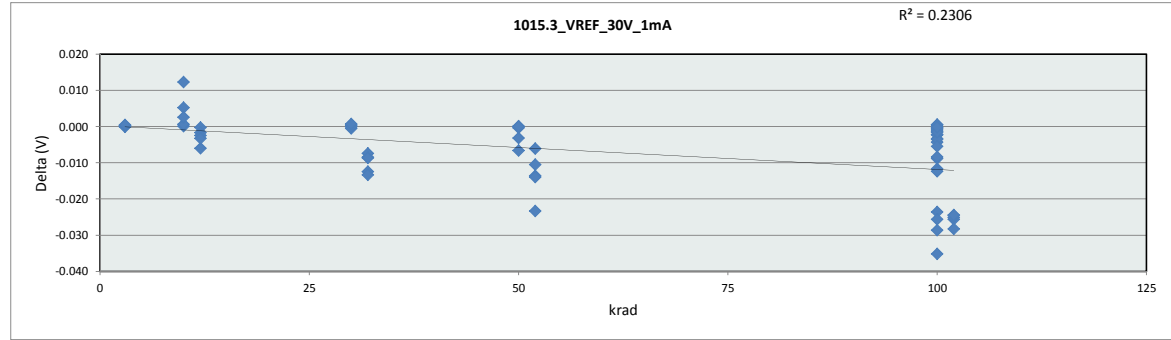

1015.3_VREF_30V_1mA		
Test Site	Junkins	Junkins
Tester	FETS01	FETS01
Test Number	EF066700	EF066700
Max Limit	5.176	V
Min Limit	5.024	V

krad	3(unbias)	10(unbias)	10(bias)	30(unbias)	30(bias)	50(unbias)	50(bias)	100(unbias)	100(bias)
LL	5.024	5.024	5.024	5.024	5.024	5.024	5.024	5.024	5.024
Min	5.085	5.083	5.084	5.081	5.098	5.083	5.107	5.082	5.097
Average	5.091	5.090	5.093	5.086	5.108	5.092	5.113	5.103	5.111
Max	5.099	5.095	5.109	5.089	5.116	5.102	5.123	5.129	5.117
UL	5.176	5.176	5.176	5.176	5.176	5.176	5.176	5.176	5.176

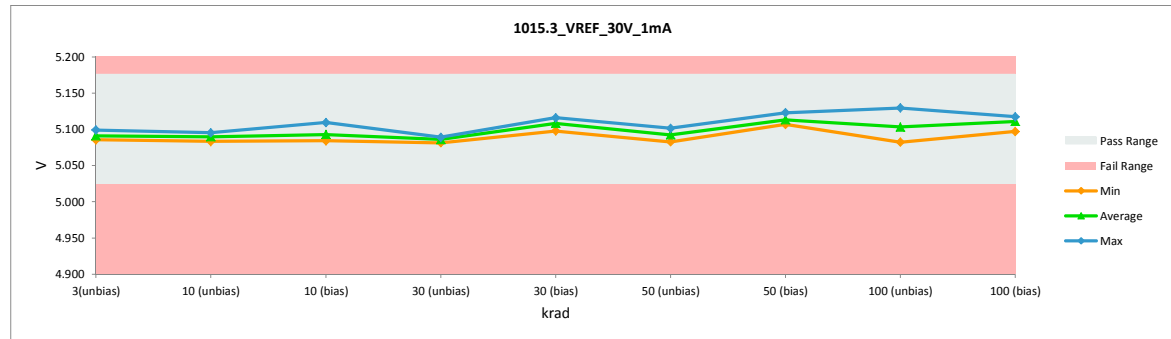

TID Report  
5962R8768106VYC

100	155	5.074	5.087	-0.012
100	156	5.100	5.108	-0.008
100	157	5.107	5.112	-0.005
100	158	5.101	5.101	0.000
102	210	5.073	5.097	-0.024
102	211	5.088	5.113	-0.026
102	214	5.092	5.117	-0.025
102	220	5.088	5.116	-0.028
102	228	5.086	5.110	-0.024
	Max	5.122	5.129	0.012
	Average	5.093	5.100	-0.007
	Min	5.073	5.081	-0.035
	Std Dev	0.009	0.013	0.010

# TID Report

## 5962R8768106VYC

1015.4_VREF_30V_10mA		
Test Site	Junkins	Junkins
Tester	FETS01	FETS01
Test Number	EF066700	EF066700
Unit	V	V
Max Limit	5.176	5.176
Min Limit	5.024	5.024

krad	Serial #	PRERLAT	POSTRLAT	Delta
3	42	5.082	5.082	0.000
3	43	5.095	5.095	0.000
3	47	5.082	5.081	0.000
3	50	5.088	5.088	0.000
3	53	5.090	5.089	0.000
10	54	5.091	5.091	0.000
10	55	5.092	5.091	0.001
10	56	5.086	5.081	0.005
10	57	5.089	5.086	0.003
10	58	5.092	5.079	0.012
12	173	5.085	5.085	0.000
12	176	5.087	5.088	-0.002
12	179	5.103	5.106	-0.003
12	180	5.074	5.080	-0.006
12	181	5.082	5.085	-0.003
30	61	5.084	5.084	0.001
30	62	5.079	5.080	0.000
30	63	5.078	5.077	0.001
30	65	5.085	5.085	0.000
30	67	5.085	5.084	0.001
32	182	5.093	5.102	-0.008
32	183	5.087	5.094	-0.007
32	184	5.097	5.109	-0.012
32	185	5.103	5.112	-0.009
32	186	5.092	5.105	-0.013
50	69	5.091	5.097	-0.006
50	70	5.075	5.078	-0.003
50	72	5.088	5.088	0.000
50	73	5.089	5.089	0.000
50	74	5.089	5.089	0.000
52	187	5.109	5.119	-0.010
52	192	5.092	5.115	-0.023
52	193	5.092	5.105	-0.013
52	195	5.098	5.104	-0.006
52	196	5.089	5.103	-0.014
100	86	5.118	5.118	0.000
100	87	5.102	5.105	-0.003
100	89	5.093	5.104	-0.011
100	91	5.076	5.099	-0.023
100	92	5.078	5.078	0.000
100	93	5.096	5.104	-0.008
100	95	5.085	5.085	0.001
100	97	5.082	5.086	-0.004
100	99	5.086	5.085	0.001
100	100	5.109	5.111	-0.002
100	102	5.095	5.096	-0.001
100	103	5.081	5.109	-0.028
100	104	5.090	5.124	-0.034
100	106	5.090	5.091	-0.002
100	108	5.092	5.093	-0.001
100	109	5.094	5.097	-0.003
100	153	5.093	5.118	-0.025
100	154	5.079	5.081	-0.001

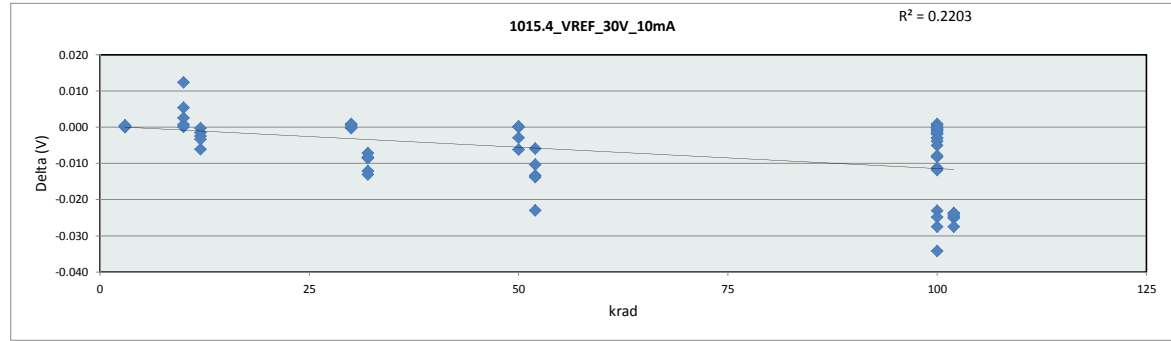

1015.4_VREF_30V_10mA		
Test Site	Junkins	Junkins
Tester	FETS01	FETS01
Test Number	EF066700	EF066700
Max Limit	5.176	V
Min Limit	5.024	V

krad	3(unbias)	10(unbias)	10(bias)	30(unbias)	30(bias)	50(unbias)	50(bias)	100(unbias)	100(bias)
LL	5.024	5.024	5.024	5.024	5.024	5.024	5.024	5.024	5.024
Min	5.081	5.079	5.080	5.078	5.094	5.078	5.103	5.078	5.093
Average	5.087	5.086	5.089	5.082	5.104	5.088	5.109	5.099	5.106
Max	5.095	5.091	5.106	5.085	5.112	5.097	5.119	5.124	5.113
UL	5.176	5.176	5.176	5.176	5.176	5.176	5.176	5.176	5.176

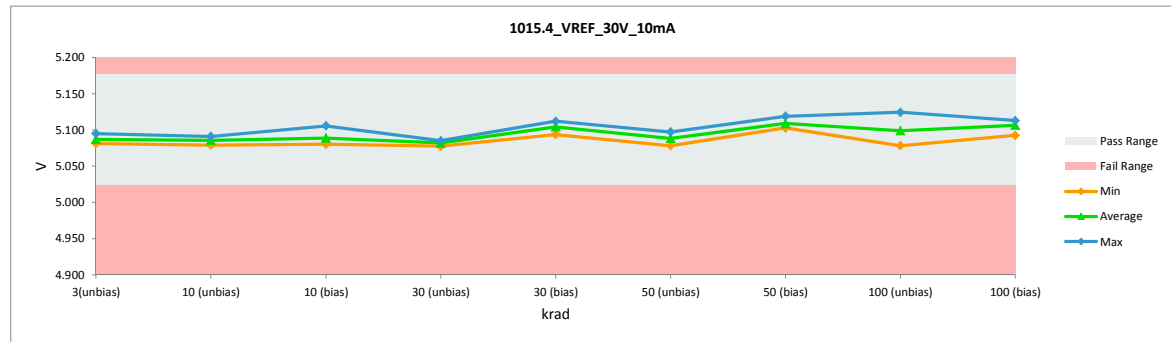

TID Report  
5962R8768106VYC

100	155	5.070	5.082	-0.012
100	156	5.096	5.104	-0.008
100	157	5.102	5.108	-0.005
100	158	5.097	5.097	0.000
102	210	5.069	5.093	-0.024
102	211	5.084	5.109	-0.025
102	214	5.088	5.113	-0.025
102	220	5.084	5.112	-0.028
102	228	5.082	5.106	-0.024
	Max	5.118	5.124	0.012
	Average	5.089	5.096	-0.007
	Min	5.069	5.077	-0.034
	Std Dev	0.009	0.012	0.010

# TID Report

## 5962R8768106VYC

1015.5_VREF_15V_10mA		
Test Site	Junkins	Junkins
Tester	FETS01	FETS01
Test Number	EF066700	EF066700
Unit	V	V
Max Limit	5.176	5.176
Min Limit	5.024	5.024

krad	Serial #	PRERLAT	POSTRLAT	Delta
3	42	5.083	5.083	0.000
3	43	5.097	5.096	0.000
3	47	5.084	5.084	0.000
3	50	5.089	5.089	0.000
3	53	5.091	5.090	0.000
10	54	5.094	5.094	0.000
10	55	5.093	5.092	0.001
10	56	5.088	5.082	0.006
10	57	5.090	5.087	0.003
10	58	5.094	5.080	0.014
12	173	5.086	5.086	0.000
12	176	5.089	5.090	-0.002
12	179	5.104	5.107	-0.002
12	180	5.075	5.081	-0.006
12	181	5.083	5.086	-0.003
30	61	5.085	5.084	0.001
30	62	5.081	5.082	0.000
30	63	5.079	5.078	0.001
30	65	5.088	5.088	0.000
30	67	5.086	5.085	0.001
32	182	5.095	5.102	-0.007
32	183	5.088	5.095	-0.006
32	184	5.098	5.109	-0.011
32	185	5.105	5.112	-0.008
32	186	5.093	5.105	-0.012
50	69	5.092	5.098	-0.006
50	70	5.076	5.079	-0.003
50	72	5.089	5.088	0.001
50	73	5.090	5.090	0.000
50	74	5.090	5.089	0.001
52	187	5.110	5.120	-0.010
52	192	5.093	5.116	-0.023
52	193	5.094	5.107	-0.013
52	195	5.099	5.104	-0.006
52	196	5.090	5.103	-0.013
100	86	5.120	5.119	0.000
100	87	5.103	5.106	-0.002
100	89	5.094	5.105	-0.010
100	91	5.077	5.099	-0.022
100	92	5.079	5.079	0.000
100	93	5.097	5.104	-0.008
100	95	5.087	5.085	0.001
100	97	5.083	5.087	-0.003
100	99	5.087	5.085	0.001
100	100	5.110	5.111	-0.001
100	102	5.096	5.096	0.000
100	103	5.082	5.109	-0.026
100	104	5.091	5.124	-0.033
100	106	5.091	5.092	-0.001
100	108	5.093	5.094	-0.001
100	109	5.095	5.097	-0.003
100	153	5.094	5.118	-0.023
100	154	5.080	5.081	-0.001

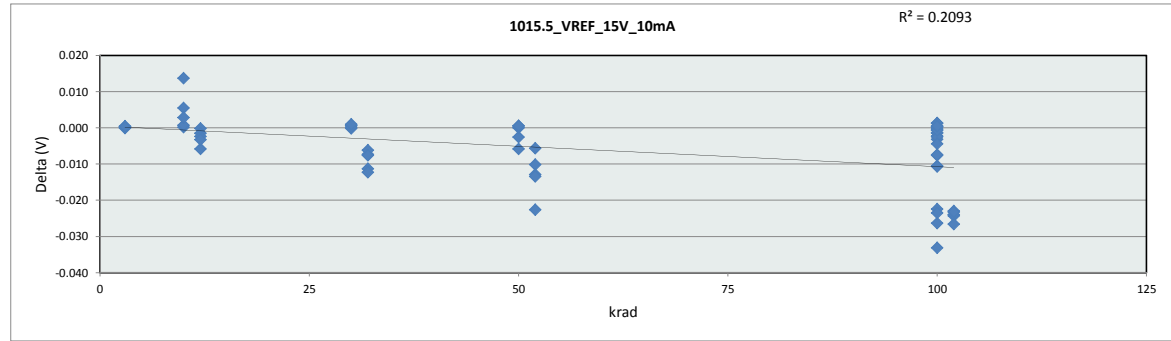

1015.5_VREF_15V_10mA		
Test Site	Junkins	Junkins
Tester	FETS01	FETS01
Test Number	EF066700	EF066700
Max Limit	5.176	V
Min Limit	5.024	V

krad	3(unbias)	10(unbias)	10(bias)	30(unbias)	30(bias)	50(unbias)	50(bias)	100(unbias)	100(bias)
LL	5.024	5.024	5.024	5.024	5.024	5.024	5.024	5.024	5.024
Min	5.083	5.080	5.081	5.079	5.095	5.079	5.103	5.079	5.093
Average	5.089	5.087	5.090	5.083	5.105	5.089	5.110	5.099	5.107
Max	5.097	5.094	5.107	5.088	5.112	5.098	5.120	5.124	5.113
UL	5.176	5.176	5.176	5.176	5.176	5.176	5.176	5.176	5.176

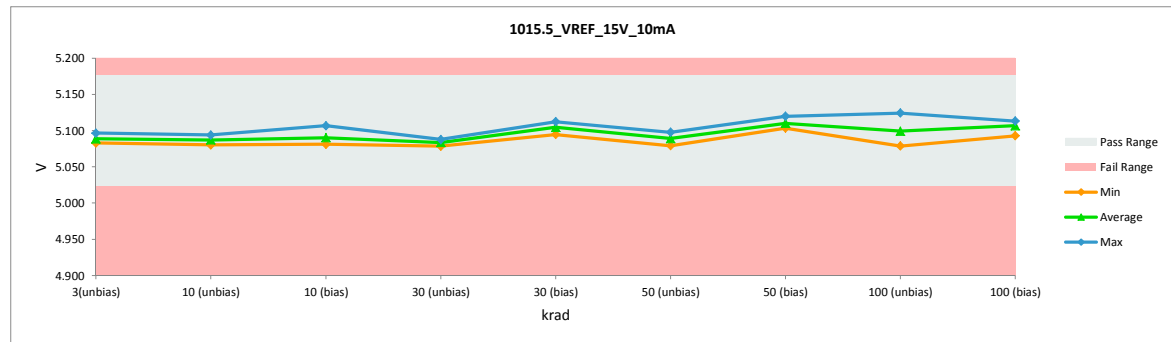



TID Report  
5962R8768106VYC

100	155	5.071	5.082	-0.011
100	156	5.097	5.104	-0.007
100	157	5.103	5.108	-0.004
100	158	5.098	5.097	0.000
102	210	5.070	5.093	-0.023
102	211	5.085	5.109	-0.024
102	214	5.089	5.113	-0.024
102	220	5.086	5.112	-0.027
102	228	5.083	5.106	-0.023
	Max	5.120	5.124	0.014
	Average	5.090	5.096	-0.006
	Min	5.070	5.078	-0.033
	Std Dev	0.009	0.012	0.010

TID Report  
5962R8768106VYC

1015.6_VREF_Line_Reg	
Test Site	Junkins
Tester	FETS01
Test Number	EF066700
Unit	mV
Max Limit	20
Min Limit	-20

krad	Serial #	PRERLAT	POSTRLAT	Delta
3	42	2.112	2.077	0.035
3	43	2.234	2.202	0.032
3	47	3.486	3.450	0.036
3	50	2.168	2.144	0.024
3	53	2.105	2.147	-0.042
10	54	3.610	3.581	0.030
10	55	1.924	1.916	0.009
10	56	2.142	1.940	0.202
10	57	2.213	2.127	0.086
10	58	3.148	1.989	1.159
12	173	2.155	2.043	0.113
12	176	2.673	2.635	0.038
12	179	2.003	1.895	0.107
12	180	2.218	2.132	0.086
12	181	1.961	1.905	0.056
30	61	1.948	1.740	0.208
30	62	2.795	2.715	0.080
30	63	2.175	2.093	0.082
30	65	3.694	3.520	0.174
30	67	1.789	1.651	0.139
32	182	2.238	1.888	0.351
32	183	2.691	2.372	0.319
32	184	2.021	1.749	0.272
32	185	2.222	1.936	0.286
32	186	2.149	1.861	0.287
50	69	1.643	1.329	0.314
50	70	2.197	1.873	0.324
50	72	1.987	1.698	0.288
50	73	2.239	1.949	0.290
50	74	1.813	1.637	0.176
52	187	2.054	1.503	0.551
52	192	2.152	1.593	0.559
52	193	2.788	2.319	0.470
52	195	2.016	1.696	0.319
52	196	2.237	1.768	0.469
100	86	2.218	1.725	0.493
100	87	2.081	1.551	0.530
100	89	1.910	1.422	0.488
100	91	1.965	1.351	0.614
100	92	1.768	1.200	0.568
100	93	1.673	1.041	0.633
100	95	1.949	1.481	0.468
100	97	1.872	1.163	0.708
100	99	1.857	1.475	0.382
100	100	1.780	1.403	0.377
100	102	2.035	1.609	0.427
100	103	2.465	1.585	0.880
100	104	1.823	0.870	0.953
100	106	2.258	1.740	0.518
100	108	1.975	1.482	0.493
100	109	1.689	1.400	0.288
100	153	2.161	1.493	0.668
100	154	1.817	1.396	0.421

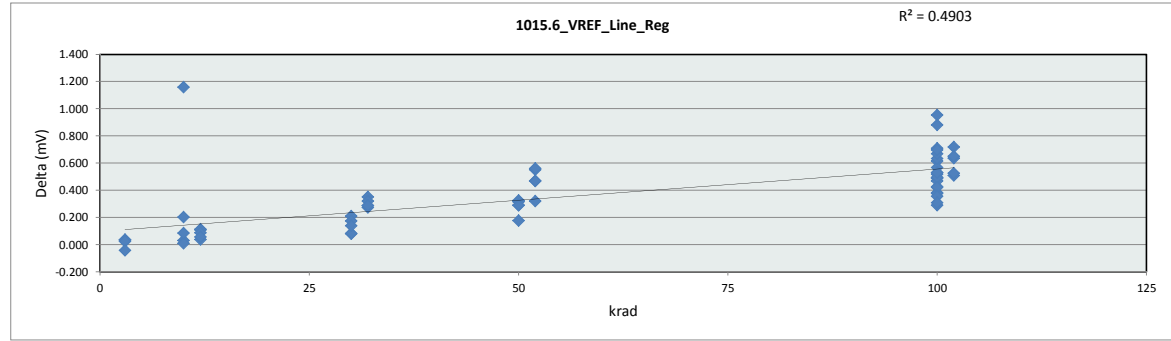

1015.6_VREF_Line_Reg	
Test Site	Junkins
Tester	FETS01
Test Number	EF066700
Max Limit	20 mV
Min Limit	-20 mV

krad	3(unbias)	10(unbias)	10(bias)	30(unbias)	30(bias)	50(unbias)	50(bias)	100(unbias)	100(bias)
LL	-20.000	-20.000	-20.000	-20.000	-20.000	-20.000	-20.000	-20.000	-20.000
Min	2.077	1.916	1.895	1.651	1.749	1.329	1.503	0.870	1.037
Average	2.404	2.311	2.122	2.344	1.961	1.697	1.776	1.441	1.451
Max	3.450	3.581	2.635	3.520	2.372	1.949	2.319	1.766	1.829
UL	20.000	20.000	20.000	20.000	20.000	20.000	20.000	20.000	20.000

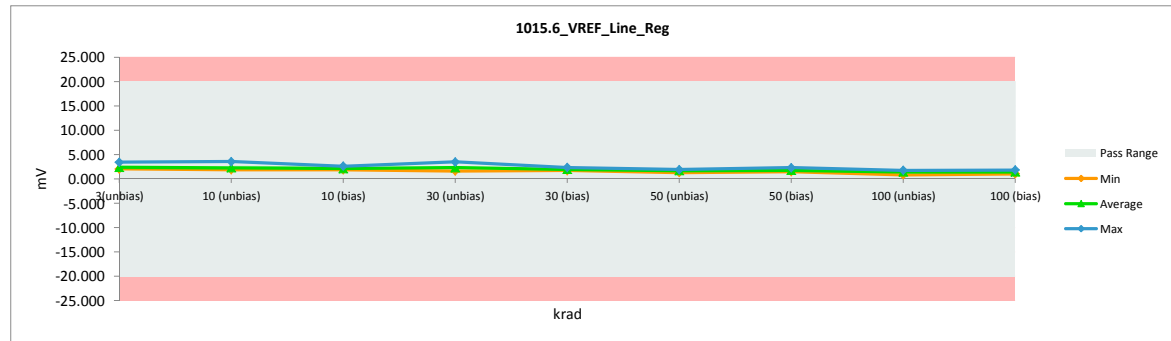

TID Report  
5962R8768106VYC

100	155	2.151	1.454	0.697
100	156	1.942	1.411	0.530
100	157	2.122	1.765	0.356
100	158	1.985	1.676	0.309
102	210	2.303	1.586	0.718
102	211	1.936	1.427	0.509
102	214	2.013	1.379	0.635
102	220	2.480	1.829	0.651
102	228	1.561	1.037	0.524
	Max	3.694	3.581	1.159
	Average	2.174	1.807	0.367
	Min	1.561	0.870	-0.042
	Std Dev	0.433	0.531	0.257

TID Report  
5962R8768106VYC

1015.7_VREF_Load_Reg		
Test Site	Junkins	Junkins
Tester	FETS01	FETS01
Test Number	EF066700	EF066700
Unit	mV	mV
Max Limit	20	20
Min Limit	-20	-20

krad	Serial #	PRERLAT	POSTRLAT	Delta
3	42	4.947	4.917	0.029
3	43	4.810	4.791	0.019
3	47	5.388	5.419	-0.032
3	50	5.255	5.218	0.037
3	53	5.204	5.227	-0.024
10	54	5.431	5.473	-0.042
10	55	4.972	4.992	-0.020
10	56	5.175	5.130	0.045
10	57	5.160	5.163	-0.003
10	58	5.241	5.360	-0.119
12	173	5.093	5.183	-0.091
12	176	5.067	5.141	-0.075
12	179	4.889	4.985	-0.096
12	180	5.286	5.361	-0.074
12	181	5.110	5.093	0.017
30	61	5.273	5.371	-0.098
30	62	4.880	5.134	-0.253
30	63	5.089	5.148	-0.059
30	65	5.331	5.497	-0.166
30	67	5.006	5.126	-0.119
32	182	5.398	5.358	0.040
32	183	5.027	4.973	0.054
32	184	5.097	5.360	-0.263
32	185	5.264	5.274	-0.011
32	186	5.433	5.463	-0.030
50	69	4.704	5.267	-0.563
50	70	5.292	5.614	-0.322
50	72	5.080	5.266	-0.186
50	73	5.268	5.486	-0.219
50	74	5.121	5.329	-0.209
52	187	5.228	4.978	0.250
52	192	5.454	5.577	-0.123
52	193	5.253	5.302	-0.049
52	195	5.139	5.109	0.030
52	196	5.366	5.336	0.030
100	86	5.067	5.544	-0.477
100	87	5.260	5.663	-0.403
100	89	5.310	5.806	-0.497
100	91	5.104	5.687	-0.583
100	92	4.908	5.351	-0.443
100	93	4.714	5.162	-0.448
100	95	5.106	5.416	-0.309
100	97	5.121	5.519	-0.399
100	99	5.006	5.343	-0.337
100	100	5.007	5.140	-0.133
100	102	5.149	5.560	-0.412
100	103	5.574	6.701	-1.128
100	104	5.297	6.170	-0.873
100	106	5.028	5.561	-0.533
100	108	5.233	5.570	-0.337
100	109	4.805	5.259	-0.454
100	153	5.387	6.556	-1.169
100	154	5.167	5.518	-0.351

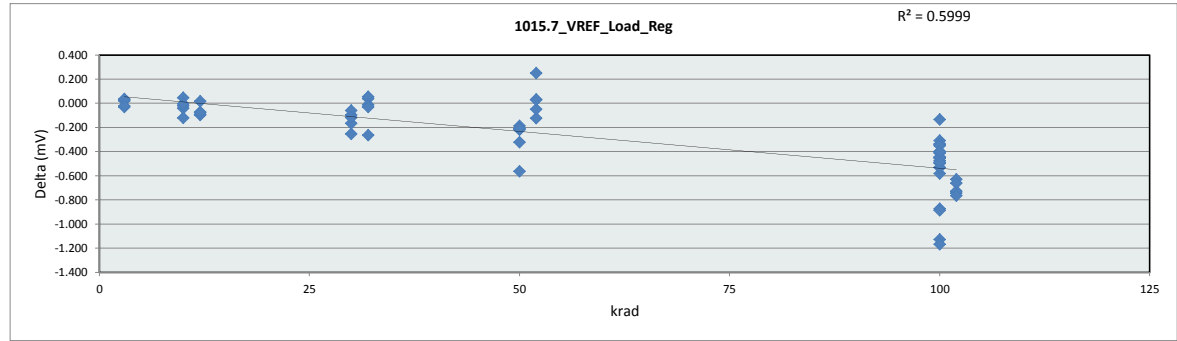

1015.7_VREF_Load_Reg		
Test Site	Junkins	
Tester	FETS01	
Test Number	EF066700	
Max Limit	20	mV
Min Limit	-20	mV

krad	3(unbias)	10(unbias)	10(bias)	30(unbias)	30(bias)	50(unbias)	50(bias)	100(unbias)	100(bias)
LL	-20.000	-20.000	-20.000	-20.000	-20.000	-20.000	-20.000	-20.000	-20.000
Min	4.791	4.992	4.985	5.126	4.973	5.266	4.978	5.140	5.540
Average	5.115	5.224	5.153	5.255	5.286	5.393	5.260	5.680	5.841
Max	5.420	5.473	5.361	5.497	5.463	5.614	5.577	6.702	6.085
UL	20.000	20.000	20.000	20.000	20.000	20.000	20.000	20.000	20.000

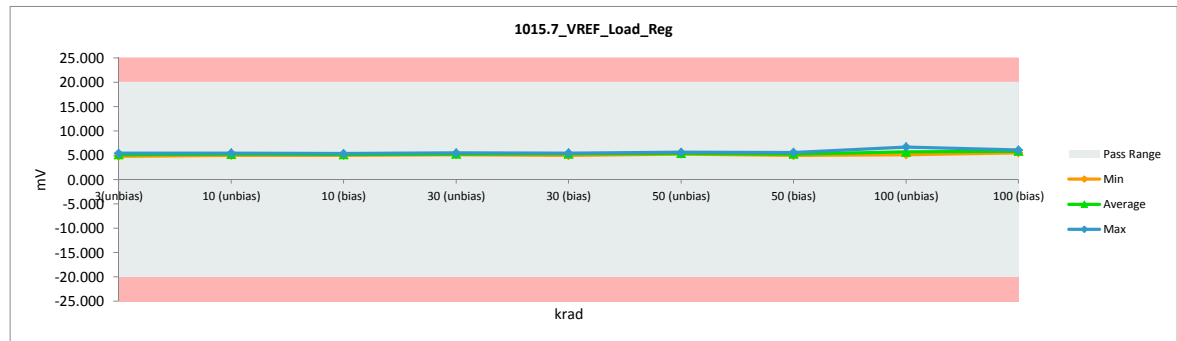

TID Report  
5962R8768106VYC

100	155	5.289	6.176	-0.887
100	156	5.281	5.813	-0.531
100	157	5.468	5.958	-0.490
100	158	5.098	5.496	-0.398
102	210	5.455	6.085	-0.631
102	211	4.991	5.735	-0.744
102	214	5.161	5.890	-0.729
102	220	5.193	5.958	-0.765
102	228	4.877	5.540	-0.662
	Max	5.574	6.701	0.250
	Average	5.158	5.445	-0.287
	Min	4.704	4.791	-1.169
	Std Dev	0.191	0.374	0.308

TID Report  
5962R8768106VYC

1020.1_Osc_Freq @ 15V		
Test Site	Junkins	Junkins
Tester	FETS01	FETS01
Test Number	EF066700	EF066700
Unit	KHz	KHz
Max Limit	440	440
Min Limit	360	360

krad	Serial #	PRERLAT	POSTRLAT	Delta
3	42	382.768	394.669	-11.901
3	43	382.129	394.013	-11.884
3	47	378.986	390.618	-11.632
3	50	382.483	394.354	-11.871
3	53	382.719	394.502	-11.783
10	54	380.942	392.966	-12.024
10	55	383.689	395.702	-12.013
10	56	382.880	394.652	-11.773
10	57	382.118	394.786	-12.668
10	58	380.612	392.890	-12.278
12	173	383.278	394.862	-11.584
12	176	382.923	394.961	-12.038
12	179	381.704	393.788	-12.083
12	180	382.365	394.625	-12.260
12	181	381.740	393.573	-11.833
30	61	379.852	392.449	-12.598
30	62	381.616	394.318	-12.702
30	63	380.919	393.522	-12.603
30	65	381.581	394.158	-12.577
30	67	383.156	395.668	-12.512
32	182	382.855	404.520	-21.665
32	183	381.522	403.454	-21.932
32	184	380.703	402.314	-21.611
32	185	382.007	403.792	-21.786
32	186	381.300	402.874	-21.574
50	69	382.059	397.060	-15.001
50	70	380.431	394.609	-14.178
50	72	382.503	395.315	-12.812
50	73	382.952	396.126	-13.174
50	74	382.111	395.216	-13.106
52	187	381.481	396.202	-14.721
52	192	381.914	396.844	-14.931
52	193	381.163	395.906	-14.742
52	195	383.497	398.406	-14.909
52	196	380.061	396.132	-16.070
100	86	381.339	396.189	-14.850
100	87	381.825	397.359	-15.534
100	89	379.538	394.553	-15.015
100	91	382.207	397.623	-15.417
100	92	383.414	398.971	-15.557
100	93	382.343	397.851	-15.508
100	95	382.949	397.360	-14.411
100	97	382.350	398.298	-15.947
100	99	382.864	397.595	-14.731
100	100	381.917	396.073	-14.156
100	102	381.620	396.279	-14.659
100	103	380.164	395.472	-15.308
100	104	379.058	394.263	-15.205
100	106	383.225	398.751	-15.526
100	108	382.997	397.670	-14.674
100	109	382.095	397.354	-15.259
100	153	379.798	395.017	-15.219
100	154	382.446	397.199	-14.754

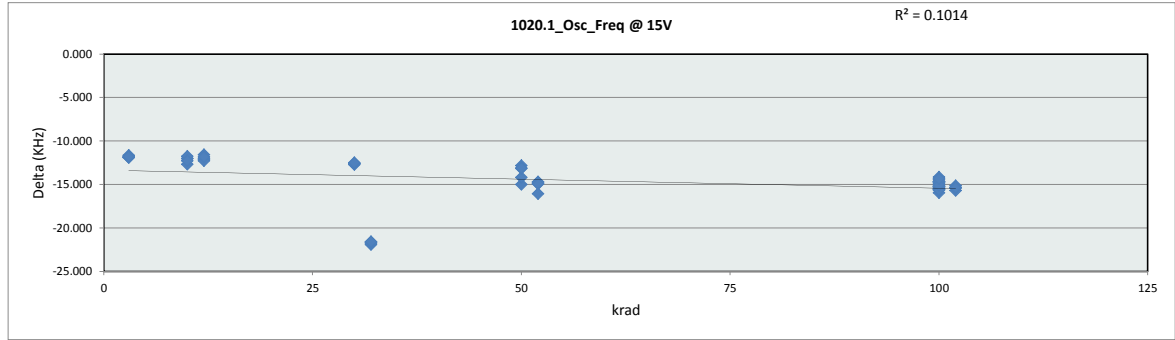

1020.1_Osc_Freq @ 15V		
Test Site	Junkins	Junkins
Tester	FETS01	FETS01
Test Number	EF066700	EF066700
Max Limit	440	KHz
Min Limit	360	KHz

krad	3(unbias)	10(unbias)	10(bias)	30(unbias)	30(bias)	50(unbias)	50(bias)	100(unbias)	100(bias)
LL	360.000	360.000	360.000	360.000	360.000	360.000	360.000	360.000	360.000
Min	390.619	392.890	393.573	392.449	402.314	394.609	395.906	393.912	395.373
Average	393.631	394.199	394.362	394.023	403.391	395.665	396.698	396.744	397.560
Max	394.669	395.702	394.961	395.668	404.520	397.060	398.406	398.971	399.251
UL	440.000	440.000	440.000	440.000	440.000	440.000	440.000	440.000	440.000

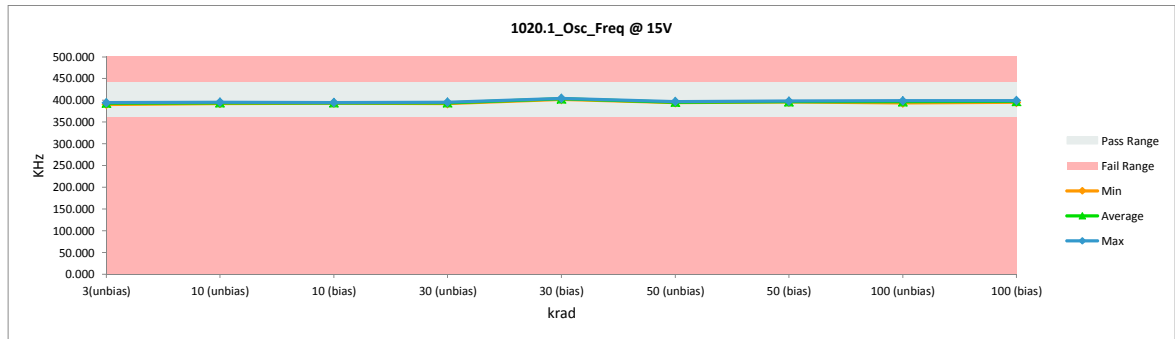

TID Report  
5962R8768106VYC

100	155	382.459	398.134	-15.675
100	156	379.279	393.912	-14.633
100	157	379.961	395.065	-15.104
100	158	383.045	397.387	-14.341
102	210	380.224	395.373	-15.148
102	211	383.552	399.251	-15.699
102	214	382.773	398.150	-15.378
102	220	381.681	397.076	-15.395
102	228	382.596	397.949	-15.353
	Max	383.689	404.520	-11.584
	Average	381.818	396.387	-14.569
	Min	378.986	390.618	-21.932
	Std Dev	1.206	2.741	2.563

# TID Report

## 5962R8768106VYC

1020.2_Osc_Freq @ 30V		
Test Site	Junkins	Junkins
Tester	FETS01	FETS01
Test Number	EF066700	EF066700
Unit	KHz	KHz
Max Limit	460	460
Min Limit	340	340

krad	Serial #	PRERLAT	POSTRLAT	Delta
3	42	382.709	394.574	-11.866
3	43	382.063	393.914	-11.850
3	47	378.845	390.457	-11.613
3	50	382.419	394.287	-11.868
3	53	382.639	394.403	-11.765
10	54	380.828	392.823	-11.995
10	55	383.625	395.619	-11.994
10	56	382.798	394.567	-11.769
10	57	382.044	394.689	-12.645
10	58	380.515	392.801	-12.286
12	173	383.204	394.776	-11.572
12	176	382.866	394.862	-11.995
12	179	381.642	393.691	-12.050
12	180	382.300	394.557	-12.257
12	181	381.666	393.483	-11.817
30	61	379.773	392.355	-12.582
30	62	381.515	394.176	-12.661
30	63	380.846	393.483	-12.636
30	65	381.456	394.030	-12.574
30	67	383.078	395.578	-12.500
32	182	382.790	404.452	-21.661
32	183	381.453	403.378	-21.925
32	184	380.634	402.236	-21.602
32	185	381.933	403.703	-21.770
32	186	381.221	402.792	-21.571
50	69	382.036	396.965	-14.929
50	70	380.395	394.503	-14.108
50	72	382.432	395.220	-12.789
50	73	382.883	396.033	-13.150
50	74	382.052	395.125	-13.072
52	187	381.416	396.098	-14.682
52	192	381.844	396.747	-14.903
52	193	381.062	395.778	-14.716
52	195	383.422	398.303	-14.881
52	196	380.006	396.039	-16.033
100	86	381.270	396.112	-14.843
100	87	381.747	397.271	-15.524
100	89	379.462	394.463	-15.000
100	91	382.133	397.532	-15.399
100	92	383.347	398.875	-15.528
100	93	382.293	397.759	-15.466
100	95	382.876	397.263	-14.387
100	97	382.272	398.201	-15.929
100	99	382.808	397.506	-14.698
100	100	381.853	395.983	-14.130
100	102	381.554	396.186	-14.632
100	103	380.098	395.383	-15.285
100	104	379.025	394.161	-15.137
100	106	383.145	398.642	-15.497
100	108	382.934	397.582	-14.648
100	109	382.028	397.263	-15.235
100	153	379.720	394.922	-15.203
100	154	382.380	397.106	-14.726

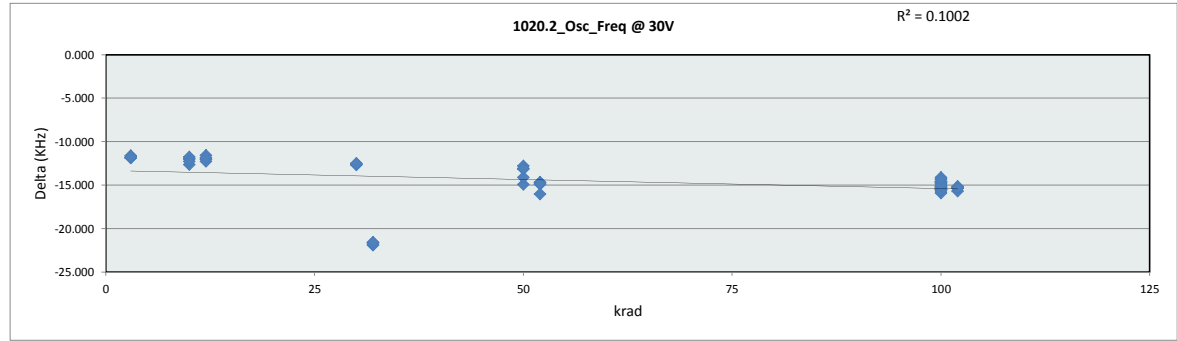

1020.2_Osc_Freq @ 30V		
Test Site	Junkins	Junkins
Tester	FETS01	FETS01
Test Number	EF066700	EF066700
Max Limit	460	KHz
Min Limit	340	KHz

krad	3(unbias)	10(unbias)	10(bias)	30(unbias)	30(bias)	50(unbias)	50(bias)	100(unbias)	100(bias)
LL	340.000	340.000	340.000	340.000	340.000	340.000	340.000	340.000	340.000
Min	390.457	392.801	393.483	392.355	402.236	394.503	395.778	393.809	395.274
Average	393.527	394.100	394.274	393.924	403.312	395.569	396.593	396.651	397.461
Max	394.574	395.619	394.862	395.578	404.452	396.965	398.304	398.875	399.168
UL	460.000	460.000	460.000	460.000	460.000	460.000	460.000	460.000	460.000

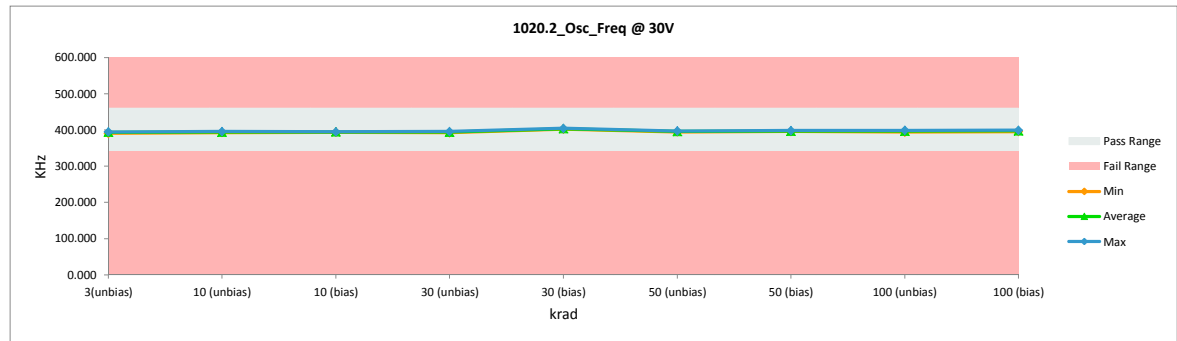



TID Report  
5962R8768106VYC

100	155	382.388	398.036	-15.649
100	156	379.210	393.809	-14.599
100	157	379.905	394.989	-15.084
100	158	382.978	397.287	-14.309
102	210	380.146	395.274	-15.129
102	211	383.487	399.168	-15.681
102	214	382.690	398.043	-15.353
102	220	381.602	396.960	-15.357
102	228	382.564	397.861	-15.298
	Max	383.625	404.452	-11.572
	Average	381.747	396.292	-14.545
	Min	378.845	390.457	-21.925
	Std Dev	1.209	2.747	2.564

TID Report  
5962R8768106VYC

1025.1_Vio		
Test Site	Junkins	Junkins
Tester	FETS01	FETS01
Test Number	EF066700	EF066700
Unit	mV	mV
Max Limit	10	10
Min Limit	-10	-10

krad	Serial #	PRERLAT	POSTRLAT	Delta
3	42	0.105	0.097	0.008
3	43	-0.437	-0.442	0.004
3	47	0.509	0.496	0.014
3	50	-0.075	-0.093	0.017
3	53	-4.197	-4.212	0.015
10	54	-1.770	-1.764	-0.006
10	55	-3.685	-3.689	0.004
10	56	-0.490	-1.175	0.685
10	57	0.831	-0.510	1.341
10	58	0.592	-0.250	0.842
12	173	-1.772	-1.502	-0.270
12	176	-0.196	0.123	-0.319
12	179	-1.327	-1.048	-0.278
12	180	-3.468	-3.316	-0.152
12	181	-0.091	0.095	-0.186
30	61	0.328	0.278	0.050
30	62	-2.434	-2.702	0.268
30	63	-0.388	-0.409	0.021
30	65	1.803	1.684	0.119
30	67	-1.608	-1.623	0.015
32	182	0.637	0.911	-0.273
32	183	-2.325	-1.863	-0.461
32	184	-0.964	-0.639	-0.325
32	185	-2.172	-2.057	-0.115
32	186	-4.897	-4.796	-0.101
50	69	-3.668	-3.481	-0.186
50	70	-4.707	-4.579	-0.128
50	72	3.015	2.929	0.086
50	73	-1.499	-1.504	0.005
50	74	-2.291	-2.237	-0.054
52	187	-2.687	-2.310	-0.378
52	192	-0.456	0.015	-0.472
52	193	-0.463	-0.193	-0.270
52	195	-2.711	-2.222	-0.489
52	196	-1.515	-0.859	-0.656
100	86	-2.095	-2.036	-0.059
100	87	-3.878	-3.937	0.059
100	89	-0.201	-0.151	-0.050
100	91	-0.818	-0.863	0.045
100	92	-2.969	-2.924	-0.046
100	93	-2.665	-2.572	-0.093
100	95	-0.885	-0.871	-0.014
100	97	-0.712	-0.700	-0.013
100	99	0.340	0.267	0.073
100	100	-4.838	-4.716	-0.122
100	102	-2.184	-2.108	-0.076
100	103	-2.188	-2.029	-0.160
100	104	-2.755	-2.533	-0.222
100	106	-2.143	-2.100	-0.042
100	108	-1.421	-1.476	0.055
100	109	1.338	1.278	0.060
100	153	-1.998	-1.826	-0.172
100	154	-2.407	-2.383	-0.024

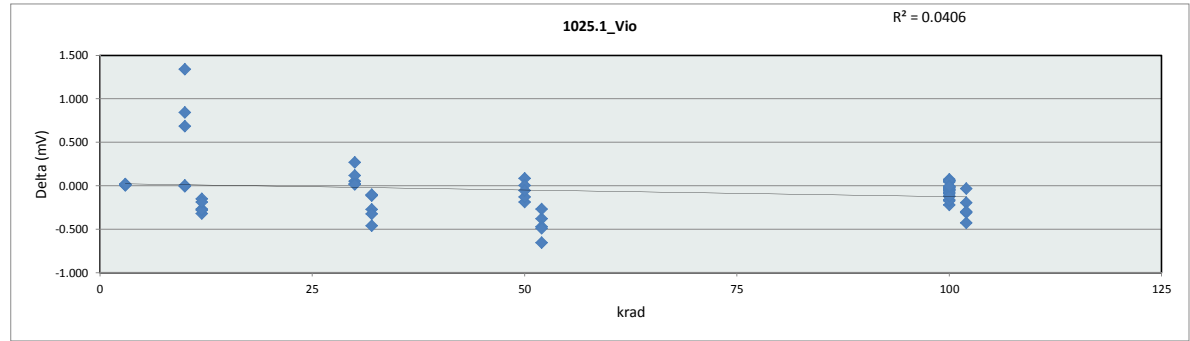

1025.1_Vio		
Test Site	Junkins	Junkins
Tester	FETS01	FETS01
Test Number	EF066700	EF066700
Max Limit	10	mV
Min Limit	-10	mV

krad	3(unbias)	10(unbias)	10(bias)	30(unbias)	30(bias)	50(unbias)	50(bias)	100(unbias)	100(bias)
LL	-10.000	-10.000	-10.000	-10.000	-10.000	-10.000	-10.000	-10.000	-10.000
Min	-4.212	-3.689	-3.316	-2.702	-4.796	-4.579	-2.310	-4.716	-1.658
Average	-0.831	-1.478	-1.129	-0.555	-1.689	-1.774	-1.114	-1.483	0.311
Max	0.496	-0.250	0.123	1.684	0.911	2.929	0.015	2.397	2.861
UL	10.000	10.000	10.000	10.000	10.000	10.000	10.000	10.000	10.000

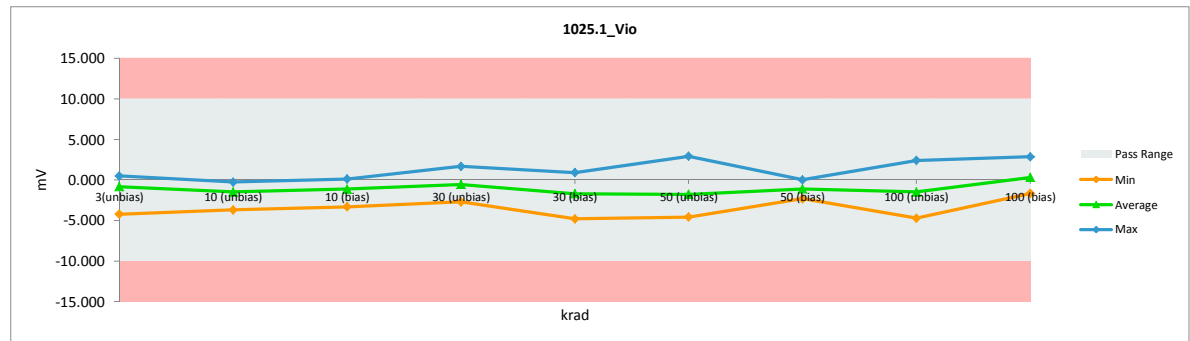

TID Report  
5962R8768106VYC

100	155	-3.402	-3.394	-0.008
100	156	2.372	2.397	-0.025
100	157	-0.465	-0.342	-0.123
100	158	0.378	0.383	-0.005
102	210	2.393	2.588	-0.195
102	211	-1.989	-1.564	-0.425
102	214	-1.968	-1.658	-0.311
102	220	2.828	2.861	-0.034
102	228	-0.971	-0.673	-0.298
	Max	3.015	2.929	1.341
	Average	-1.254	-1.192	-0.062
	Min	-4.897	-4.796	-0.656
	Std Dev	1.850	1.798	0.295

TID Report  
5962R8768106VYC

1040.1_SS Charge Current		
Test Site	Junkins	Junkins
Tester	FETS01	FETS01
Test Number	EF066700	EF066700
Unit	uA	uA
Max Limit	-3	-3
Min Limit	-20	-20

krad	Serial #	PRERLAT	POSTRLAT	Delta
3	42	-7.733	-7.736	0.004
3	43	-7.871	-7.862	-0.009
3	47	-7.860	-7.843	-0.017
3	50	-7.829	-7.821	-0.008
3	53	-7.496	-7.479	-0.017
10	54	-7.729	-7.673	-0.056
10	55	-7.762	-7.722	-0.040
10	56	-7.662	-7.502	-0.160
10	57	-7.861	-7.620	-0.241
10	58	-7.647	-7.594	-0.053
12	173	-7.710	-7.660	-0.050
12	176	-7.603	-7.551	-0.052
12	179	-7.717	-7.634	-0.084
12	180	-7.842	-7.760	-0.082
12	181	-7.635	-7.560	-0.075
30	61	-7.708	-7.580	-0.128
30	62	-7.532	-7.385	-0.147
30	63	-7.826	-7.698	-0.128
30	65	-7.775	-7.425	-0.350
30	67	-7.611	-7.465	-0.146
32	182	-7.579	-7.486	-0.092
32	183	-7.575	-7.569	-0.005
32	184	-7.681	-7.418	-0.263
32	185	-7.651	-7.529	-0.122
32	186	-7.560	-7.360	-0.200
50	69	-7.712	-7.208	-0.504
50	70	-7.830	-7.386	-0.444
50	72	-7.722	-7.548	-0.174
50	73	-7.739	-7.536	-0.203
50	74	-7.525	-7.319	-0.206
52	187	-7.663	-7.333	-0.330
52	192	-7.710	-7.332	-0.377
52	193	-7.650	-7.228	-0.422
52	195	-7.605	-7.122	-0.483
52	196	-7.636	-6.736	-0.900
100	86	-7.615	-7.214	-0.401
100	87	-7.545	-7.057	-0.488
100	89	-7.832	-7.223	-0.609
100	91	-7.510	-7.036	-0.474
100	92	-7.635	-7.133	-0.503
100	93	-7.554	-7.041	-0.514
100	95	-7.530	-7.220	-0.310
100	97	-7.620	-7.027	-0.593
100	99	-7.625	-7.262	-0.363
100	100	-7.703	-7.379	-0.324
100	102	-7.691	-7.247	-0.444
100	103	-7.790	-6.808	-0.982
100	104	-7.798	-6.809	-0.988
100	106	-7.664	-7.262	-0.402
100	108	-7.499	-7.106	-0.394
100	109	-7.795	-7.376	-0.418
100	153	-7.753	-6.829	-0.924
100	154	-7.364	-6.981	-0.383

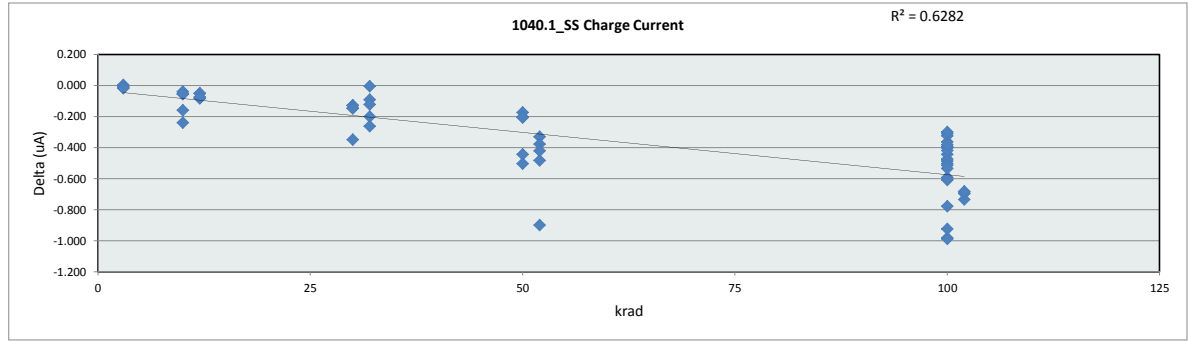

1040.1_SS Charge Current		
Test Site	Junkins	
Tester	FETS01	
Test Number	EF066700	
Max Limit	-3	uA
Min Limit	-20	uA

krad	3(unbias)	10(unbias)	10(bias)	30(unbias)	30(bias)	50(unbias)	50(bias)	100(unbias)	100(bias)
LL	-20.000	-20.000	-20.000	-20.000	-20.000	-20.000	-20.000	-20.000	-20.000
Min	-7.862	-7.722	-7.760	-7.698	-7.570	-7.548	-7.333	-7.379	-7.164
Average	-7.748	-7.622	-7.633	-7.511	-7.473	-7.399	-7.150	-7.122	-7.068
Max	-7.479	-7.502	-7.551	-7.385	-7.360	-7.208	-6.736	-6.808	-6.976
UL	-3.000	-3.000	-3.000	-3.000	-3.000	-3.000	-3.000	-3.000	-3.000

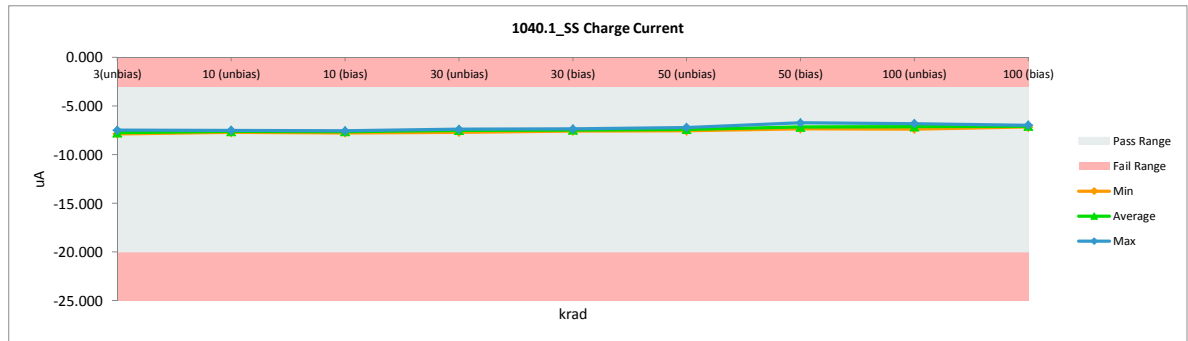

TID Report  
5962R8768106VYC

100	155	-7.675	-6.898	-0.777
100	156	-7.745	-7.210	-0.535
100	157	-7.799	-7.194	-0.605
100	158	-7.675	-7.374	-0.300
102	210	-7.899	-7.164	-0.736
102	211	-7.782	-7.087	-0.696
102	214	-7.672	-6.976	-0.696
102	220	-7.759	-7.072	-0.686
102	228	-7.723	-7.040	-0.683
	Max	-7.364	-6.736	0.004
	Average	-7.686	-7.334	-0.351
	Min	-7.899	-7.862	-0.988
	Std Dev	0.111	0.280	0.270

# TID Report

## 5962R8768106VYC

1040.2_SS Discharge Current		
Test Site	Junkins	Junkins
Tester	FETS01	FETS01
Test Number	EF066700	EF066700
Unit	mA	mA
Max Limit	9.5	9.5
Min Limit	1	1

krad	Serial #	PRERLAT	POSTRLAT	Delta
3	42	6.368	6.313	0.056
3	43	6.354	6.287	0.067
3	47	6.240	6.192	0.048
3	50	6.129	6.068	0.061
3	53	6.429	6.378	0.051
10	54	6.511	6.344	0.167
10	55	6.500	6.353	0.147
10	56	6.353	6.246	0.108
10	57	6.467	6.213	0.254
10	58	6.428	6.449	-0.021
12	173	6.490	6.242	0.248
12	176	6.170	5.900	0.269
12	179	6.455	6.134	0.321
12	180	6.227	5.924	0.303
12	181	6.497	6.226	0.271
30	61	6.655	6.265	0.390
30	62	6.278	5.890	0.388
30	63	6.223	5.847	0.375
30	65	6.451	5.977	0.475
30	67	6.474	6.112	0.362
32	182	6.291	5.688	0.603
32	183	6.442	5.711	0.731
32	184	6.671	5.900	0.771
32	185	6.479	5.805	0.675
32	186	6.516	5.808	0.708
50	69	6.576	5.652	0.924
50	70	6.617	5.798	0.819
50	72	6.540	6.029	0.511
50	73	6.399	5.862	0.537
50	74	6.519	5.961	0.558
52	187	6.484	5.198	1.287
52	192	6.744	5.337	1.406
52	193	6.192	4.808	1.384
52	195	6.537	5.109	1.429
52	196	6.463	5.053	1.411
100	86	6.451	5.478	0.972
100	87	6.434	5.383	1.051
100	89	6.744	5.653	1.091
100	91	6.404	5.356	1.048
100	92	6.551	5.486	1.065
100	93	6.488	5.413	1.075
100	95	6.366	5.509	0.857
100	97	6.293	5.165	1.127
100	99	6.479	5.542	0.938
100	100	6.653	5.804	0.849
100	102	6.666	5.701	0.965
100	103	6.607	5.253	1.354
100	104	6.733	5.387	1.346
100	106	6.385	5.381	1.003
100	108	6.516	5.579	0.937
100	109	6.484	5.462	1.022
100	153	6.508	5.213	1.295
100	154	6.280	5.333	0.947

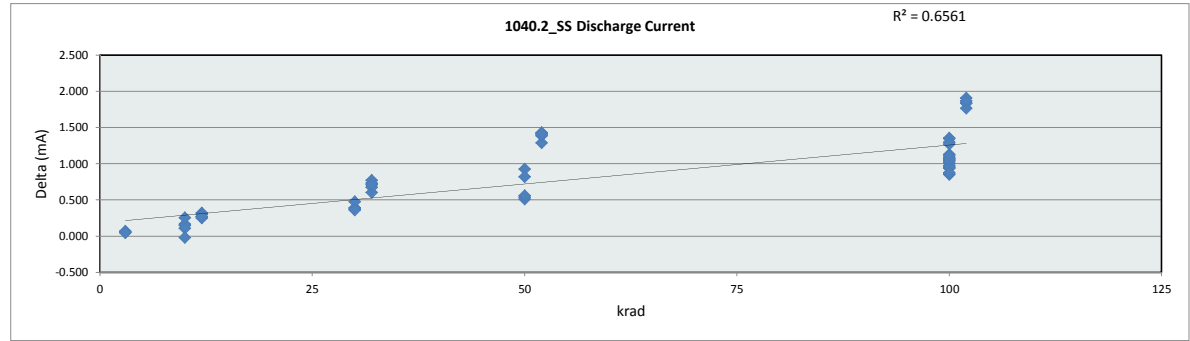

1040.2_SS Discharge Current		
Test Site	Junkins	Junkins
Tester	FETS01	FETS01
Test Number	EF066700	EF066700
Max Limit	9.5	mA
Min Limit	1	mA

krad	3(unbias)	10 (unbias)	10 (bias)	30 (unbias)	30 (bias)	50 (unbias)	50 (bias)	100 (unbias)	100 (bias)
LL	1.000	1.000	1.000	1.000	1.000	1.000	1.000	1.000	1.000
Min	6.068	6.213	5.900	5.847	5.688	5.652	4.808	5.165	4.320
Average	6.248	6.321	6.085	6.018	5.782	5.861	5.101	5.463	4.701
Max	6.378	6.449	6.242	6.265	5.901	6.029	5.337	5.804	5.041
UL	9.500	9.500	9.500	9.500	9.500	9.500	9.500	9.500	9.500

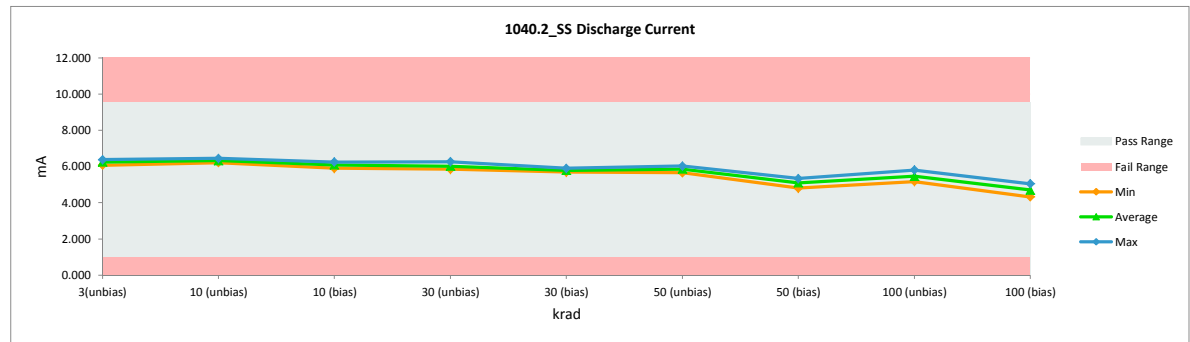

TID Report  
5962R8768106VYC

100	155	6.606	5.337	1.269
100	156	6.662	5.613	1.049
100	157	6.666	5.553	1.113
100	158	6.466	5.588	0.879
102	210	6.875	5.041	1.834
102	211	6.418	4.583	1.836
102	214	6.564	4.660	1.905
102	220	6.083	4.320	1.763
102	228	6.768	4.903	1.865
	Max	6.875	6.449	1.905
	Average	6.473	5.658	0.815
	Min	6.083	4.320	-0.021
	Std Dev	0.163	0.482	0.521

TID Report  
5962R8768106VYC

1045.2_VOL(OUTA) @ 20mA		
Test Site	Junkins	Junkins
Tester	FETS01	FETS01
Test Number	EF066700	EF066700
Unit	V	V
Max Limit	0.4	0.4
Min Limit	0.01	0.01

krad	Serial #	PRERLAT	POSTRLAT	Delta
3	42	0.140	0.142	-0.002
3	43	0.132	0.133	-0.001
3	47	0.132	0.132	-0.001
3	50	0.137	0.139	-0.001
3	53	0.139	0.140	-0.001
10	54	0.128	0.129	-0.001
10	55	0.144	0.145	-0.001
10	56	0.143	0.140	0.002
10	57	0.139	0.143	-0.004
10	58	0.127	0.139	-0.012
12	173	0.140	0.144	-0.003
12	176	0.144	0.147	-0.004
12	179	0.138	0.142	-0.005
12	180	0.139	0.144	-0.005
12	181	0.138	0.141	-0.003
30	61	0.135	0.138	-0.003
30	62	0.136	0.139	-0.003
30	63	0.142	0.144	-0.002
30	65	0.138	0.128	0.010
30	67	0.142	0.141	0.001
32	182	0.141	0.155	-0.013
32	183	0.139	0.156	-0.017
32	184	0.136	0.147	-0.010
32	185	0.140	0.156	-0.016
32	186	0.138	0.151	-0.013
50	69	0.139	0.143	-0.004
50	70	0.128	0.132	-0.004
50	72	0.141	0.143	-0.002
50	73	0.145	0.147	-0.002
50	74	0.139	0.140	-0.001
52	187	0.138	0.162	-0.024
52	192	0.135	0.157	-0.022
52	193	0.140	0.157	-0.017
52	195	0.139	0.157	-0.019
52	196	0.127	0.146	-0.019
100	86	0.140	0.145	-0.005
100	87	0.139	0.145	-0.005
100	89	0.131	0.137	-0.006
100	91	0.139	0.143	-0.005
100	92	0.140	0.145	-0.005
100	93	0.139	0.144	-0.006
100	95	0.141	0.146	-0.005
100	97	0.138	0.145	-0.006
100	99	0.141	0.146	-0.006
100	100	0.139	0.144	-0.005
100	102	0.138	0.143	-0.005
100	103	0.127	0.135	-0.007
100	104	0.132	0.139	-0.006
100	106	0.143	0.149	-0.005
100	108	0.140	0.145	-0.005
100	109	0.139	0.144	-0.006
100	153	0.130	0.136	-0.006
100	154	0.141	0.146	-0.005

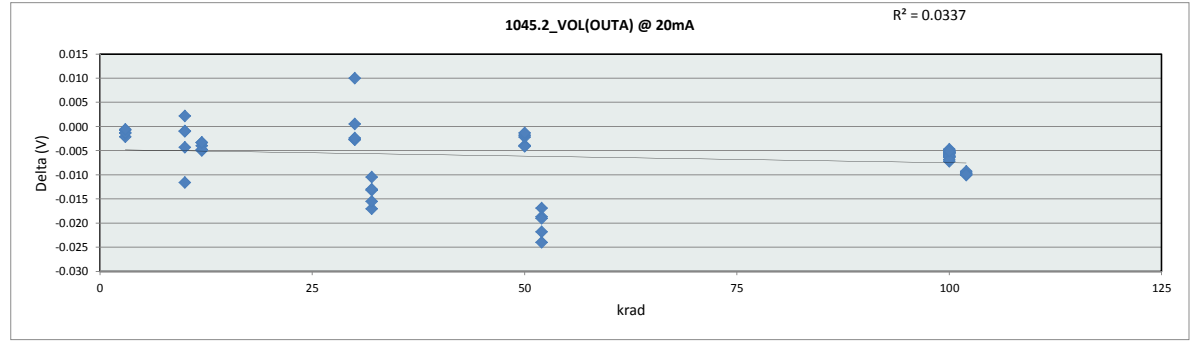

1045.2_VOL(OUTA) @ 20mA		
Test Site	Junkins	Junkins
Tester	FETS01	FETS01
Test Number	EF066700	EF066700
Max Limit	0.4	V
Min Limit	0.01	V

krad	3(unbias)	10(unbias)	10(bias)	30(unbias)	30(bias)	50(unbias)	50(bias)	100(unbias)	100(bias)
LL	0.010	0.010	0.010	0.010	0.010	0.010	0.010	0.010	0.010
Min	0.132	0.129	0.141	0.128	0.147	0.132	0.146	0.135	0.141
Average	0.137	0.139	0.144	0.138	0.153	0.141	0.156	0.143	0.148
Max	0.142	0.145	0.148	0.144	0.156	0.147	0.162	0.149	0.151
UL	0.400	0.400	0.400	0.400	0.400	0.400	0.400	0.400	0.400

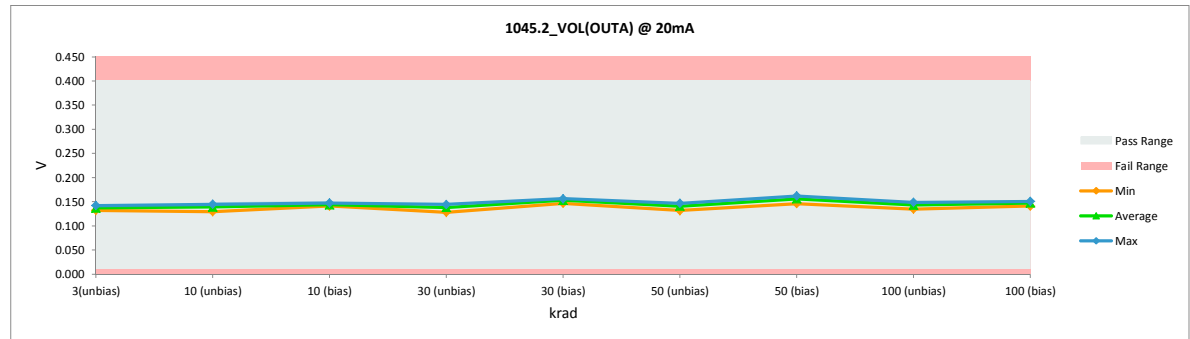



TID Report  
5962R8768106VYC

100	155	0.139	0.145	-0.006
100	156	0.134	0.140	-0.006
100	157	0.133	0.140	-0.007
100	158	0.142	0.147	-0.005
102	210	0.132	0.141	-0.010
102	211	0.141	0.151	-0.010
102	214	0.140	0.150	-0.010
102	220	0.139	0.148	-0.009
102	228	0.138	0.148	-0.010
	Max	0.145	0.162	0.010
	Average	0.138	0.144	-0.006
	Min	0.127	0.128	-0.024
	Std Dev	0.004	0.007	0.006

TID Report  
5962R8768106VYC

1045.3_VOL(OUTA) @ 200mA		
Test Site	Junkins	Junkins
Tester	FETS01	FETS01
Test Number	EF066700	EF066700
Unit	V	V
Max Limit	2.2	2.2
Min Limit	0.1	0.1

krad	Serial #	PRERLAT	POSTRLAT	Delta
3	42	0.395	0.396	-0.001
3	43	0.395	0.396	-0.001
3	47	0.402	0.403	-0.001
3	50	0.403	0.405	-0.001
3	53	0.385	0.386	-0.001
10	54	0.389	0.392	-0.002
10	55	0.393	0.394	-0.002
10	56	0.390	0.389	0.002
10	57	0.393	0.393	0.001
10	58	0.389	0.385	0.004
12	173	0.386	0.389	-0.003
12	176	0.394	0.397	-0.003
12	179	0.388	0.392	-0.004
12	180	0.407	0.412	-0.004
12	181	0.381	0.384	-0.003
30	61	0.384	0.389	-0.005
30	62	0.389	0.394	-0.005
30	63	0.401	0.406	-0.005
30	65	0.394	0.406	-0.012
30	67	0.386	0.391	-0.004
32	182	0.390	0.396	-0.006
32	183	0.388	0.394	-0.006
32	184	0.381	0.388	-0.007
32	185	0.388	0.392	-0.004
32	186	0.382	0.388	-0.006
50	69	0.390	0.400	-0.010
50	70	0.392	0.401	-0.009
50	72	0.387	0.393	-0.006
50	73	0.394	0.400	-0.007
50	74	0.384	0.392	-0.008
52	187	0.386	0.397	-0.011
52	192	0.379	0.389	-0.011
52	193	0.395	0.408	-0.013
52	195	0.386	0.397	-0.011
52	196	0.390	0.401	-0.011
100	86	0.387	0.398	-0.011
100	87	0.388	0.399	-0.011
100	89	0.387	0.399	-0.011
100	91	0.384	0.394	-0.010
100	92	0.386	0.397	-0.011
100	93	0.381	0.392	-0.010
100	95	0.388	0.398	-0.010
100	97	0.390	0.403	-0.013
100	99	0.386	0.397	-0.010
100	100	0.384	0.393	-0.009
100	102	0.383	0.394	-0.011
100	103	0.391	0.403	-0.013
100	104	0.387	0.399	-0.012
100	106	0.390	0.401	-0.011
100	108	0.384	0.394	-0.010
100	109	0.391	0.402	-0.011
100	153	0.389	0.400	-0.012
100	154	0.386	0.396	-0.010

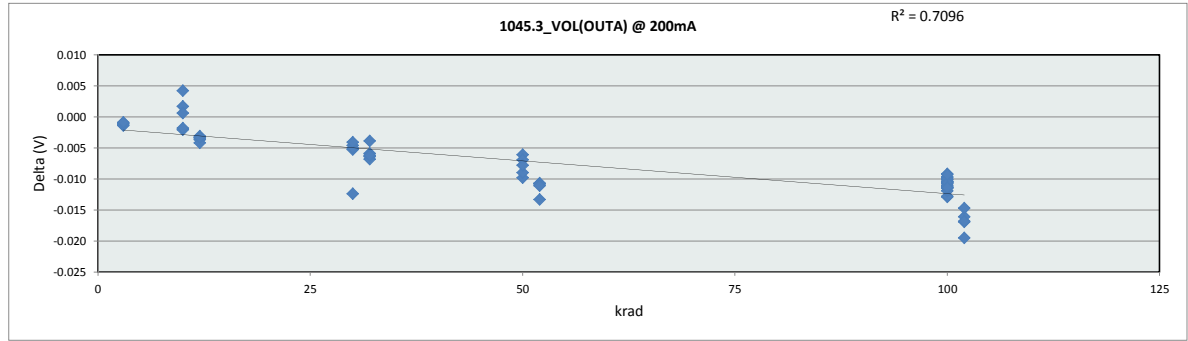

1045.3_VOL(OUTA) @ 200mA		
Test Site	Junkins	Junkins
Tester	FETS01	FETS01
Test Number	EF066700	EF066700
Max Limit	2.2	V
Min Limit	0.1	V

krad	3(unbias)	10 (unbias)	10 (bias)	30 (unbias)	30 (bias)	50 (unbias)	50 (bias)	100 (unbias)	100 (bias)
LL	0.100	0.100	0.100	0.100	0.100	0.100	0.100	0.100	0.100
Min	0.386	0.385	0.384	0.389	0.388	0.392	0.389	0.392	0.398
Average	0.397	0.390	0.395	0.397	0.392	0.397	0.399	0.398	0.407
Max	0.405	0.395	0.412	0.406	0.397	0.401	0.408	0.403	0.423
UL	2.200	2.200	2.200	2.200	2.200	2.200	2.200	2.200	2.200

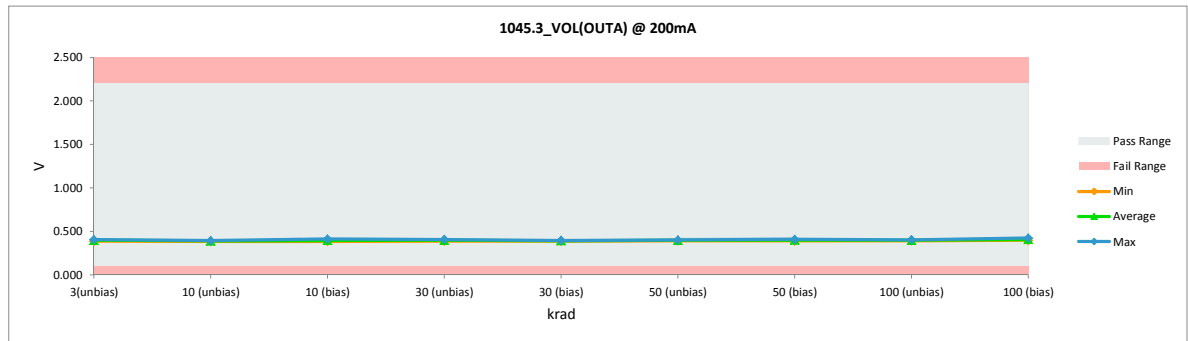

TID Report  
5962R8768106VYC

100	155	0.382	0.394	-0.011
100	156	0.387	0.398	-0.011
100	157	0.387	0.398	-0.011
100	158	0.389	0.399	-0.009
102	210	0.387	0.403	-0.016
102	211	0.394	0.411	-0.017
102	214	0.386	0.403	-0.017
102	220	0.403	0.423	-0.019
102	228	0.383	0.398	-0.015
	Max	0.407	0.423	0.004
	Average	0.389	0.397	-0.008
	Min	0.379	0.384	-0.019
	Std Dev	0.006	0.007	0.005

TID Report  
5962R8768106VYC

1045.4_VOL(OUTB) @ 20mA		
Test Site	Junkins	Junkins
Tester	FETS01	FETS01
Test Number	EF066700	EF066700
Unit	V	V
Max Limit	0.4	0.4
Min Limit	0.01	0.01

krad	Serial #	PRERLAT	POSTRLAT	Delta
3	42	0.139	0.141	-0.002
3	43	0.130	0.131	-0.001
3	47	0.130	0.130	0.000
3	50	0.136	0.137	-0.001
3	53	0.137	0.138	-0.001
10	54	0.128	0.129	-0.001
10	55	0.140	0.142	-0.001
10	56	0.142	0.138	0.004
10	57	0.138	0.143	-0.005
10	58	0.126	0.138	-0.012
12	173	0.139	0.142	-0.003
12	176	0.141	0.145	-0.004
12	179	0.136	0.141	-0.004
12	180	0.136	0.140	-0.004
12	181	0.136	0.139	-0.003
30	61	0.135	0.137	-0.002
30	62	0.135	0.137	-0.002
30	63	0.140	0.142	-0.002
30	65	0.136	0.125	0.011
30	67	0.139	0.139	0.001
32	182	0.140	0.153	-0.013
32	183	0.138	0.154	-0.016
32	184	0.134	0.145	-0.010
32	185	0.139	0.154	-0.015
32	186	0.136	0.149	-0.013
50	69	0.138	0.141	-0.003
50	70	0.127	0.130	-0.003
50	72	0.140	0.142	-0.002
50	73	0.143	0.144	-0.001
50	74	0.138	0.139	-0.001
52	187	0.137	0.161	-0.023
52	192	0.134	0.155	-0.021
52	193	0.138	0.155	-0.016
52	195	0.138	0.155	-0.018
52	196	0.126	0.145	-0.018
100	86	0.138	0.143	-0.005
100	87	0.137	0.143	-0.006
100	89	0.130	0.136	-0.006
100	91	0.137	0.142	-0.005
100	92	0.139	0.144	-0.006
100	93	0.138	0.144	-0.006
100	95	0.139	0.144	-0.005
100	97	0.135	0.142	-0.007
100	99	0.139	0.145	-0.006
100	100	0.138	0.142	-0.005
100	102	0.136	0.141	-0.005
100	103	0.127	0.133	-0.007
100	104	0.131	0.137	-0.006
100	106	0.142	0.148	-0.006
100	108	0.138	0.143	-0.005
100	109	0.137	0.143	-0.005
100	153	0.129	0.135	-0.006
100	154	0.139	0.144	-0.005

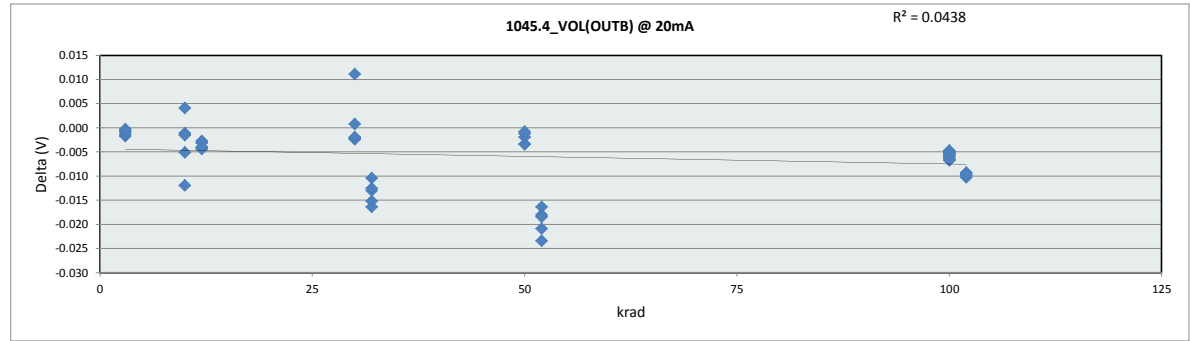

1045.4_VOL(OUTB) @ 20mA		
Test Site	Junkins	Junkins
Tester	FETS01	FETS01
Test Number	EF066700	EF066700
Max Limit	0.4	V
Min Limit	0.01	V

krad	3(unbias)	10(unbias)	10(bias)	30(unbias)	30(bias)	50(unbias)	50(bias)	100(unbias)	100(bias)
LL	0.010	0.010	0.010	0.010	0.010	0.010	0.010	0.010	0.010
Min	0.130	0.129	0.139	0.125	0.145	0.130	0.145	0.134	0.141
Average	0.135	0.138	0.141	0.136	0.151	0.139	0.154	0.142	0.146
Max	0.141	0.143	0.145	0.142	0.154	0.144	0.161	0.148	0.150
UL	0.400	0.400	0.400	0.400	0.400	0.400	0.400	0.400	0.400

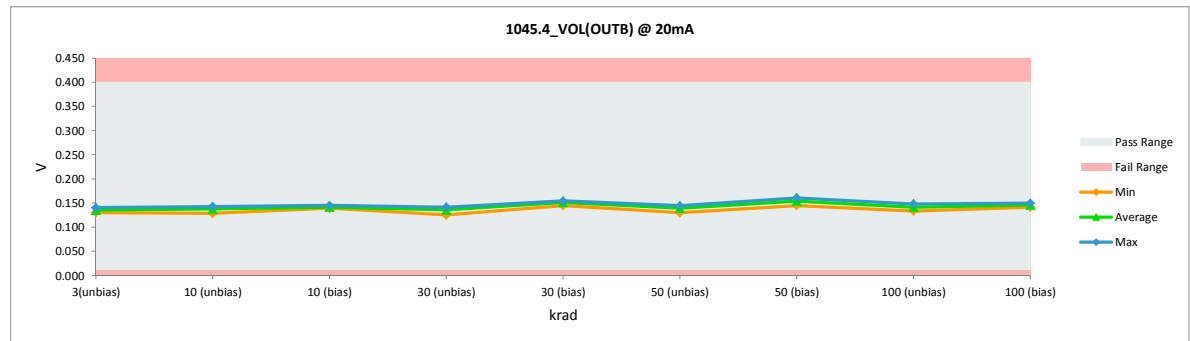

TID Report  
5962R8768106VYC

100	155	0.136	0.143	-0.007
100	156	0.132	0.139	-0.007
100	157	0.132	0.138	-0.007
100	158	0.141	0.146	-0.005
102	210	0.132	0.141	-0.009
102	211	0.139	0.150	-0.010
102	214	0.138	0.148	-0.010
102	220	0.136	0.145	-0.009
102	228	0.135	0.145	-0.010
	Max	0.143	0.161	0.011
	Average	0.136	0.142	-0.006
	Min	0.126	0.125	-0.023
	Std Dev	0.004	0.007	0.006

# TID Report

## 5962R8768106VYC

1045.5_VOL(OUTB) @ 200mA		
Test Site	Junkins	Junkins
Tester	FETS01	FETS01
Test Number	EF066700	EF066700
Unit	V	V
Max Limit	2.2	2.2
Min Limit	0.1	0.1

krad	Serial #	PRERLAT	POSTRLAT	Delta
3	42	0.395	0.397	-0.002
3	43	0.395	0.396	-0.002
3	47	0.402	0.403	-0.001
3	50	0.404	0.405	-0.001
3	53	0.384	0.385	-0.001
10	54	0.390	0.392	-0.002
10	55	0.389	0.391	-0.002
10	56	0.391	0.387	0.004
10	57	0.394	0.393	0.001
10	58	0.390	0.386	0.004
12	173	0.385	0.388	-0.003
12	176	0.393	0.396	-0.003
12	179	0.388	0.391	-0.003
12	180	0.406	0.410	-0.004
12	181	0.381	0.383	-0.003
30	61	0.384	0.388	-0.004
30	62	0.390	0.394	-0.004
30	63	0.401	0.405	-0.005
30	65	0.393	0.399	-0.007
30	67	0.384	0.388	-0.004
32	182	0.390	0.396	-0.006
32	183	0.387	0.392	-0.006
32	184	0.379	0.385	-0.006
32	185	0.386	0.392	-0.006
32	186	0.381	0.386	-0.005
50	69	0.389	0.398	-0.009
50	70	0.391	0.400	-0.008
50	72	0.387	0.393	-0.007
50	73	0.393	0.400	-0.007
50	74	0.384	0.391	-0.007
52	187	0.387	0.397	-0.010
52	192	0.379	0.388	-0.009
52	193	0.396	0.408	-0.012
52	195	0.384	0.395	-0.011
52	196	0.389	0.400	-0.011
100	86	0.387	0.397	-0.010
100	87	0.385	0.396	-0.011
100	89	0.387	0.398	-0.011
100	91	0.383	0.393	-0.010
100	92	0.385	0.396	-0.011
100	93	0.381	0.391	-0.010
100	95	0.388	0.398	-0.010
100	97	0.390	0.402	-0.012
100	99	0.386	0.396	-0.011
100	100	0.382	0.391	-0.009
100	102	0.382	0.393	-0.010
100	103	0.390	0.403	-0.013
100	104	0.386	0.398	-0.012
100	106	0.391	0.402	-0.011
100	108	0.383	0.393	-0.010
100	109	0.390	0.401	-0.011
100	153	0.388	0.400	-0.012
100	154	0.384	0.394	-0.010

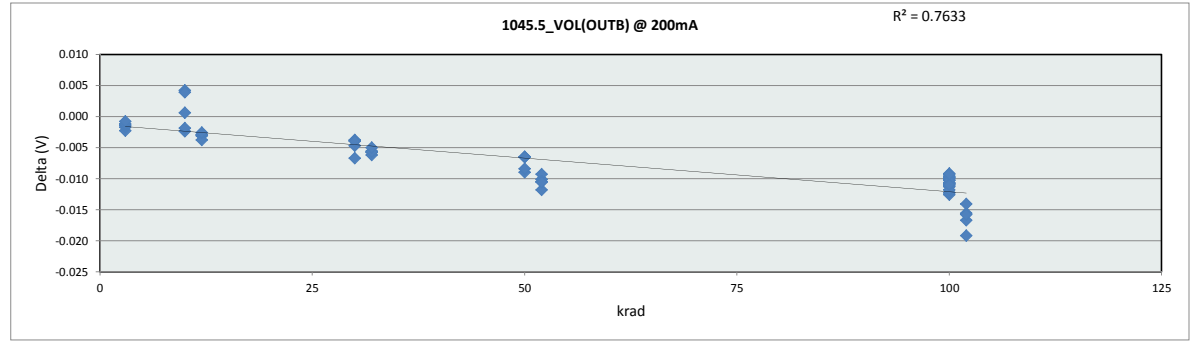

1045.5_VOL(OUTB) @ 200mA		
Test Site	Junkins	Junkins
Tester	FETS01	FETS01
Test Number	EF066700	EF066700
Max Limit	2.2	V
Min Limit	0.1	V

krad	3(unbias)	10(unbias)	10(bias)	30(unbias)	30(bias)	50(unbias)	50(bias)	100(unbias)	100(bias)
LL	0.100	0.100	0.100	0.100	0.100	0.100	0.100	0.100	0.100
Min	0.385	0.386	0.383	0.388	0.385	0.391	0.388	0.391	0.395
Average	0.397	0.390	0.394	0.395	0.390	0.396	0.398	0.397	0.406
Max	0.405	0.393	0.410	0.405	0.396	0.400	0.408	0.403	0.421
UL	2.200	2.200	2.200	2.200	2.200	2.200	2.200	2.200	2.200

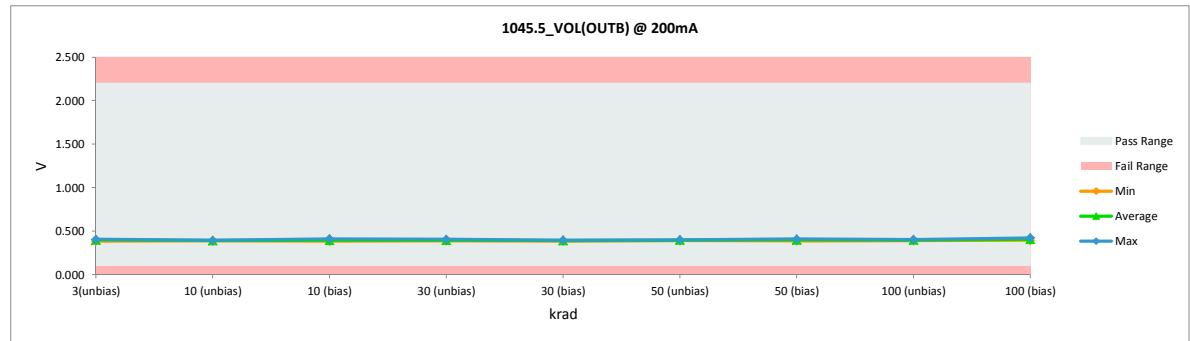

TID Report  
5962R8768106VYC

100	155	0.381	0.392	-0.011
100	156	0.387	0.397	-0.010
100	157	0.386	0.397	-0.011
100	158	0.389	0.399	-0.009
102	210	0.387	0.402	-0.016
102	211	0.393	0.410	-0.017
102	214	0.385	0.401	-0.016
102	220	0.402	0.421	-0.019
102	228	0.381	0.395	-0.014
	Max	0.406	0.421	0.004
	Average	0.388	0.396	-0.008
	Min	0.379	0.383	-0.019
	Std Dev	0.006	0.007	0.005

# TID Report

## 5962R8768106VYC

1045.6_VOL(OUTA) UVLO @ 20mA		
Test Site	Junkins	Junkins
Tester	FETS01	FETS01
Test Number	EF066700	EF066700
Unit	V	V
Max Limit	1.2	1.2
Min Limit	0.01	0.01

krad	Serial #	PRERLAT	POSTRLAT	Delta
3	42	0.150	0.152	-0.002
3	43	0.141	0.143	-0.002
3	47	0.142	0.142	0.000
3	50	0.148	0.149	-0.001
3	53	0.149	0.150	-0.001
10	54	0.139	0.140	-0.001
10	55	0.154	0.155	-0.001
10	56	0.153	0.151	0.002
10	57	0.149	0.154	-0.005
10	58	0.137	0.149	-0.012
12	173	0.151	0.154	-0.003
12	176	0.154	0.157	-0.004
12	179	0.148	0.153	-0.005
12	180	0.149	0.154	-0.004
12	181	0.148	0.151	-0.003
30	61	0.146	0.148	-0.003
30	62	0.146	0.149	-0.003
30	63	0.152	0.154	-0.002
30	65	0.148	0.138	0.010
30	67	0.152	0.151	0.001
32	182	0.152	0.164	-0.013
32	183	0.150	0.166	-0.016
32	184	0.146	0.157	-0.010
32	185	0.150	0.166	-0.015
32	186	0.148	0.160	-0.012
50	69	0.149	0.153	-0.004
50	70	0.138	0.142	-0.004
50	72	0.151	0.154	-0.003
50	73	0.155	0.157	-0.001
50	74	0.149	0.150	-0.001
52	187	0.148	0.172	-0.023
52	192	0.145	0.166	-0.021
52	193	0.150	0.167	-0.017
52	195	0.149	0.167	-0.018
52	196	0.137	0.156	-0.019
100	86	0.150	0.155	-0.005
100	87	0.149	0.155	-0.006
100	89	0.140	0.147	-0.006
100	91	0.149	0.154	-0.005
100	92	0.150	0.156	-0.006
100	93	0.148	0.154	-0.006
100	95	0.151	0.156	-0.005
100	97	0.148	0.154	-0.007
100	99	0.151	0.156	-0.006
100	100	0.149	0.154	-0.005
100	102	0.148	0.153	-0.005
100	103	0.138	0.144	-0.007
100	104	0.142	0.148	-0.006
100	106	0.154	0.159	-0.005
100	108	0.149	0.155	-0.005
100	109	0.149	0.155	-0.006
100	153	0.140	0.147	-0.006
100	154	0.151	0.156	-0.005

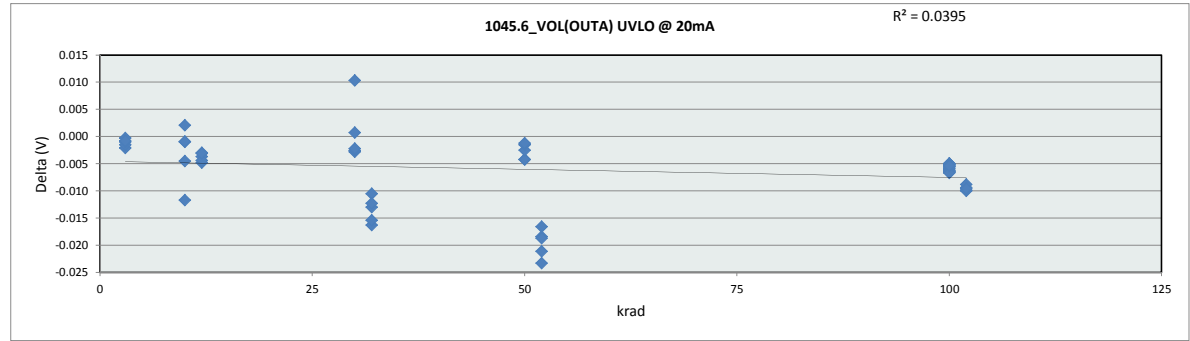

1045.6_VOL(OUTA) UVLO @		
Test Site	Junkins	
Tester	FETS01	
Test Number	EF066700	
Max Limit	1.2	V
Min Limit	0.01	V

krad	3(unbias)	10(unbias)	10(bias)	30(unbias)	30(bias)	50(unbias)	50(bias)	100(unbias)	100(bias)
LL	0.010	0.010	0.010	0.010	0.010	0.010	0.010	0.010	0.010
Min	0.142	0.140	0.151	0.138	0.157	0.142	0.156	0.144	0.151
Average	0.147	0.149	0.154	0.148	0.163	0.151	0.166	0.153	0.157
Max	0.152	0.155	0.157	0.154	0.166	0.157	0.172	0.159	0.161
UL	1.200	1.200	1.200	1.200	1.200	1.200	1.200	1.200	1.200

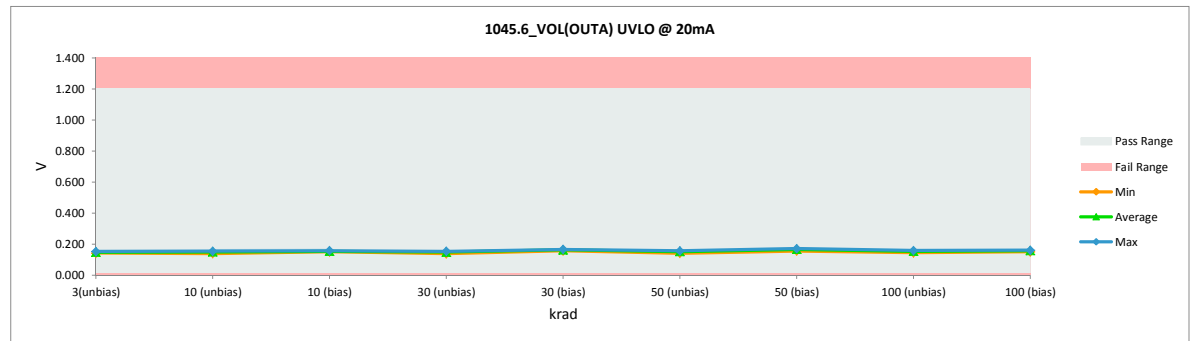



TID Report  
5962R8768106VYC

100	155	0.149	0.155	-0.006
100	156	0.144	0.150	-0.006
100	157	0.143	0.150	-0.007
100	158	0.152	0.157	-0.005
102	210	0.141	0.151	-0.009
102	211	0.151	0.161	-0.010
102	214	0.150	0.160	-0.010
102	220	0.149	0.158	-0.009
102	228	0.148	0.158	-0.010
	Max	0.155	0.172	0.010
	Average	0.148	0.154	-0.006
	Min	0.137	0.138	-0.023
	Std Dev	0.004	0.007	0.006

# TID Report

## 5962R8768106VYC

1045.7_VOL(OUTB) UVLO @ 20mA		
Test Site	Junkins	Junkins
Tester	FETS01	FETS01
Test Number	EF066700	EF066700
Unit	V	V
Max Limit	1.2	1.2
Min Limit	0.01	0.01

krad	Serial #	PRERLAT	POSTRLAT	Delta
3	42	0.149	0.151	-0.002
3	43	0.140	0.141	-0.001
3	47	0.140	0.141	0.000
3	50	0.146	0.147	-0.001
3	53	0.148	0.148	0.000
10	54	0.138	0.139	-0.001
10	55	0.151	0.152	-0.001
10	56	0.153	0.149	0.004
10	57	0.148	0.153	-0.005
10	58	0.137	0.149	-0.012
12	173	0.149	0.152	-0.003
12	176	0.152	0.155	-0.004
12	179	0.147	0.151	-0.004
12	180	0.146	0.150	-0.004
12	181	0.147	0.149	-0.002
30	61	0.145	0.148	-0.002
30	62	0.145	0.147	-0.002
30	63	0.150	0.152	-0.002
30	65	0.147	0.136	0.011
30	67	0.150	0.149	0.001
32	182	0.151	0.163	-0.012
32	183	0.148	0.164	-0.016
32	184	0.145	0.155	-0.010
32	185	0.149	0.164	-0.015
32	186	0.147	0.159	-0.012
50	69	0.148	0.152	-0.003
50	70	0.137	0.140	-0.004
50	72	0.150	0.152	-0.002
50	73	0.154	0.155	-0.001
50	74	0.148	0.149	-0.001
52	187	0.148	0.171	-0.023
52	192	0.144	0.165	-0.020
52	193	0.149	0.165	-0.016
52	195	0.148	0.165	-0.018
52	196	0.136	0.154	-0.018
100	86	0.148	0.154	-0.006
100	87	0.148	0.153	-0.006
100	89	0.140	0.146	-0.006
100	91	0.147	0.152	-0.005
100	92	0.149	0.155	-0.006
100	93	0.148	0.154	-0.006
100	95	0.150	0.154	-0.005
100	97	0.146	0.152	-0.006
100	99	0.150	0.155	-0.006
100	100	0.148	0.153	-0.005
100	102	0.146	0.152	-0.005
100	103	0.137	0.144	-0.007
100	104	0.141	0.148	-0.006
100	106	0.153	0.158	-0.005
100	108	0.148	0.153	-0.006
100	109	0.147	0.154	-0.006
100	153	0.139	0.146	-0.006
100	154	0.149	0.154	-0.005

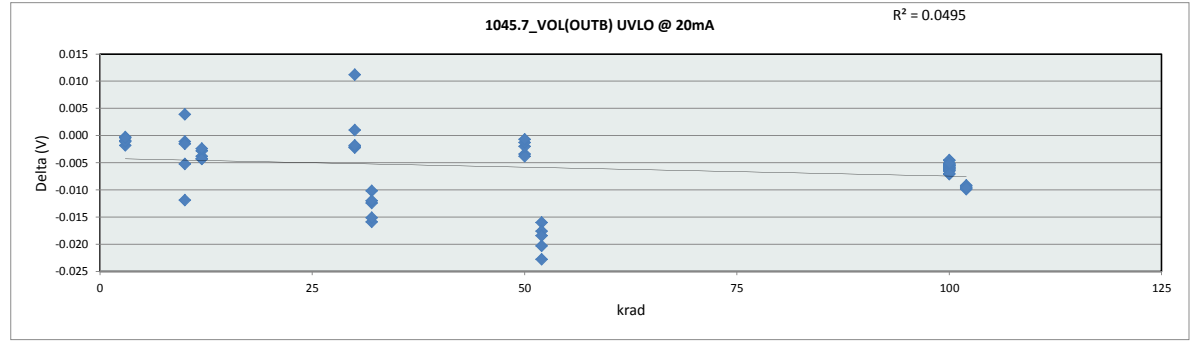

1045.7_VOL(OUTB) UVLO @		
Test Site	Junkins	Junkins
Tester	FETS01	FETS01
Test Number	EF066700	EF066700
Max Limit	1.2	V
Min Limit	0.01	V

krad	3(unbias)	10(unbias)	10(bias)	30(unbias)	30(bias)	50(unbias)	50(bias)	100(unbias)	100(bias)
LL	0.010	0.010	0.010	0.010	0.010	0.010	0.010	0.010	0.010
Min	0.141	0.139	0.149	0.136	0.155	0.140	0.155	0.144	0.151
Average	0.146	0.148	0.152	0.146	0.161	0.150	0.164	0.152	0.156
Max	0.151	0.153	0.156	0.152	0.165	0.155	0.171	0.158	0.160
UL	1.200	1.200	1.200	1.200	1.200	1.200	1.200	1.200	1.200

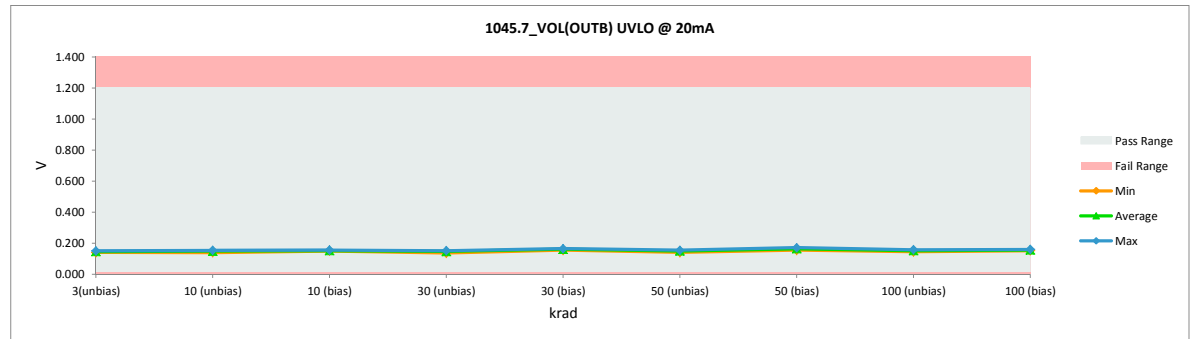

TID Report  
5962R8768106VYC

100	155	0.147	0.153	-0.006
100	156	0.143	0.149	-0.007
100	157	0.142	0.149	-0.007
100	158	0.151	0.156	-0.005
102	210	0.142	0.151	-0.009
102	211	0.150	0.160	-0.010
102	214	0.148	0.158	-0.010
102	220	0.146	0.155	-0.009
102	228	0.146	0.155	-0.010
	Max	0.154	0.171	0.011
	Average	0.146	0.153	-0.006
	Min	0.136	0.136	-0.023
	Std Dev	0.004	0.007	0.006

TID Report  
5962R8768106VYC

1045.8_VOH(OUTA) @ 20mA		
Test Site	Junkins	Junkins
Tester	FETS01	FETS01
Test Number	EF066700	EF066700
Unit	V	V
Max Limit	19	19
Min Limit	13	13

krad	Serial #	PRERLAT	POSTRLAT	Delta
3	42	13.545	13.539	0.006
3	43	13.543	13.539	0.003
3	47	13.542	13.542	0.000
3	50	13.541	13.539	0.002
3	53	13.551	13.551	0.001
10	54	13.549	13.548	0.001
10	55	13.547	13.546	0.001
10	56	13.546	13.557	-0.010
10	57	13.543	13.546	-0.003
10	58	13.547	13.552	-0.004
12	173	13.547	13.542	0.005
12	176	13.549	13.541	0.008
12	179	13.547	13.536	0.011
12	180	13.541	13.531	0.009
12	181	13.554	13.550	0.005
30	61	13.550	13.550	0.001
30	62	13.547	13.547	0.000
30	63	13.540	13.541	-0.001
30	65	13.545	13.598	-0.053
30	67	13.548	13.559	-0.011
32	182	13.548	13.486	0.062
32	183	13.551	13.480	0.071
32	184	13.553	13.503	0.050
32	185	13.551	13.483	0.068
32	186	13.553	13.495	0.059
50	69	13.547	13.550	-0.003
50	70	13.552	13.553	-0.001
50	72	13.547	13.550	-0.003
50	73	13.542	13.548	-0.006
50	74	13.551	13.559	-0.008
52	187	13.552	13.489	0.063
52	192	13.557	13.501	0.056
52	193	13.547	13.510	0.037
52	195	13.555	13.511	0.044
52	196	13.554	13.507	0.047
100	86	13.547	13.546	0.002
100	87	13.552	13.550	0.002
100	89	13.552	13.548	0.003
100	91	13.554	13.552	0.003
100	92	13.551	13.549	0.002
100	93	13.554	13.551	0.003
100	95	13.550	13.549	0.001
100	97	13.545	13.542	0.003
100	99	13.549	13.547	0.002
100	100	13.552	13.549	0.002
100	102	13.552	13.551	0.001
100	103	13.550	13.547	0.003
100	104	13.551	13.550	0.002
100	106	13.547	13.545	0.002
100	108	13.552	13.550	0.003
100	109	13.546	13.544	0.002
100	153	13.549	13.547	0.002
100	154	13.552	13.550	0.002

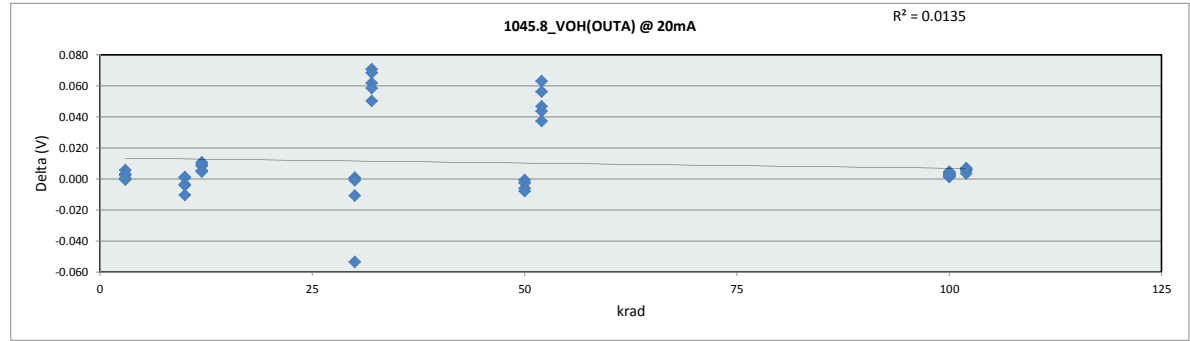

1045.8_VOH(OUTA) @ 20m		
Test Site	Junkins	Junkins
Tester	FETS01	FETS01
Test Number	EF066700	EF066700
Max Limit	19	V
Min Limit	13	V

krad	3(unbias)	10(unbias)	10(bias)	30(unbias)	30(bias)	50(unbias)	50(bias)	100(unbias)	100(bias)
LL	13.000	13.000	13.000	13.000	13.000	13.000	13.000	13.000	13.000
Min	13.539	13.546	13.531	13.541	13.480	13.548	13.489	13.542	13.536
Average	13.542	13.550	13.540	13.559	13.489	13.552	13.504	13.548	13.545
Max	13.551	13.557	13.550	13.598	13.503	13.559	13.511	13.552	13.551
UL	19.000	19.000	19.000	19.000	19.000	19.000	19.000	19.000	19.000

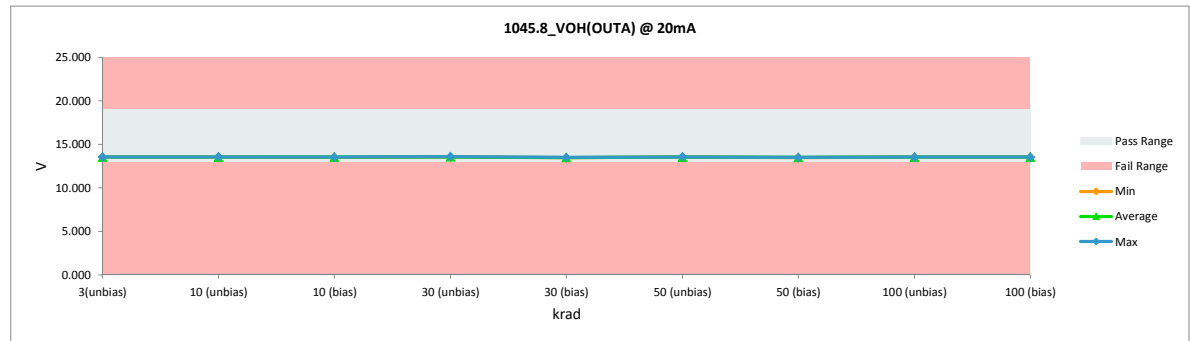

TID Report  
5962R8768106VYC

100	155	13.555	13.552	0.003
100	156	13.554	13.549	0.005
100	157	13.553	13.549	0.005
100	158	13.550	13.546	0.004
102	210	13.554	13.549	0.005
102	211	13.548	13.542	0.007
102	214	13.553	13.547	0.006
102	220	13.540	13.536	0.003
102	228	13.558	13.551	0.007
	Max	13.558	13.598	0.071
	Average	13.549	13.540	0.010
	Min	13.540	13.480	-0.053
	Std Dev	0.004	0.021	0.022

# TID Report

## 5962R8768106VYC

1045.9_VOH(OUTA) @ 200mA		
Test Site	Junkins	Junkins
Tester	FETS01	FETS01
Test Number	EF066700	EF066700
Unit	V	V
Max Limit	19	19
Min Limit	12	12

krad	Serial #	PRERLAT	POSTRLAT	Delta
3	42	13.395	13.391	0.005
3	43	13.393	13.390	0.003
3	47	13.390	13.390	0.000
3	50	13.389	13.387	0.002
3	53	13.404	13.404	0.000
10	54	13.401	13.399	0.001
10	55	13.398	13.396	0.002
10	56	13.398	13.408	-0.010
10	57	13.394	13.397	-0.003
10	58	13.399	13.405	-0.005
12	173	13.399	13.394	0.005
12	176	13.400	13.392	0.007
12	179	13.399	13.389	0.010
12	180	13.388	13.380	0.009
12	181	13.408	13.404	0.005
30	61	13.403	13.402	0.002
30	62	13.399	13.399	0.001
30	63	13.390	13.391	0.000
30	65	13.396	13.439	-0.043
30	67	13.401	13.411	-0.010
32	182	13.400	13.345	0.055
32	183	13.403	13.340	0.063
32	184	13.407	13.362	0.045
32	185	13.403	13.343	0.059
32	186	13.406	13.355	0.052
50	69	13.399	13.400	-0.001
50	70	13.403	13.402	0.001
50	72	13.399	13.401	-0.001
50	73	13.393	13.398	-0.004
50	74	13.404	13.410	-0.006
52	187	13.405	13.347	0.058
52	192	13.410	13.359	0.052
52	193	13.397	13.363	0.034
52	195	13.408	13.367	0.041
52	196	13.405	13.362	0.043
100	86	13.399	13.396	0.003
100	87	13.405	13.401	0.004
100	89	13.404	13.399	0.005
100	91	13.408	13.404	0.004
100	92	13.404	13.401	0.003
100	93	13.408	13.403	0.004
100	95	13.403	13.401	0.002
100	97	13.397	13.392	0.004
100	99	13.402	13.398	0.004
100	100	13.405	13.401	0.003
100	102	13.404	13.402	0.003
100	103	13.401	13.396	0.004
100	104	13.403	13.400	0.003
100	106	13.400	13.396	0.004
100	108	13.406	13.401	0.004
100	109	13.397	13.394	0.004
100	153	13.401	13.397	0.004
100	154	13.405	13.401	0.004

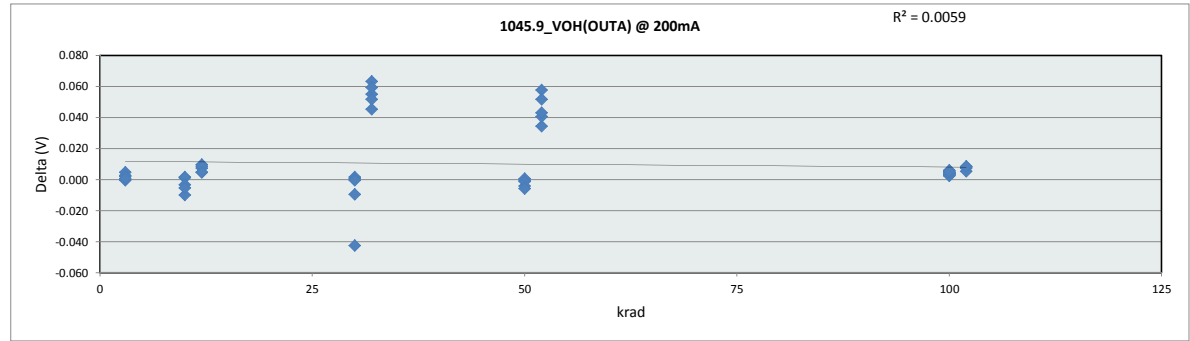

1045.9_VOH(OUTA) @ 200mA		
Test Site	Junkins	Junkins
Tester	FETS01	FETS01
Test Number	EF066700	EF066700
Max Limit	19	V
Min Limit	12	V

krad	3(unbias)	10(unbias)	10(bias)	30(unbias)	30(bias)	50(unbias)	50(bias)	100(unbias)	100(bias)
LL	12.000	12.000	12.000	12.000	12.000	12.000	12.000	12.000	12.000
Min	13.387	13.396	13.380	13.391	13.340	13.398	13.347	13.393	13.383
Average	13.393	13.401	13.392	13.408	13.349	13.402	13.360	13.399	13.394
Max	13.404	13.408	13.404	13.439	13.362	13.410	13.367	13.404	13.403
UL	19.000	19.000	19.000	19.000	19.000	19.000	19.000	19.000	19.000

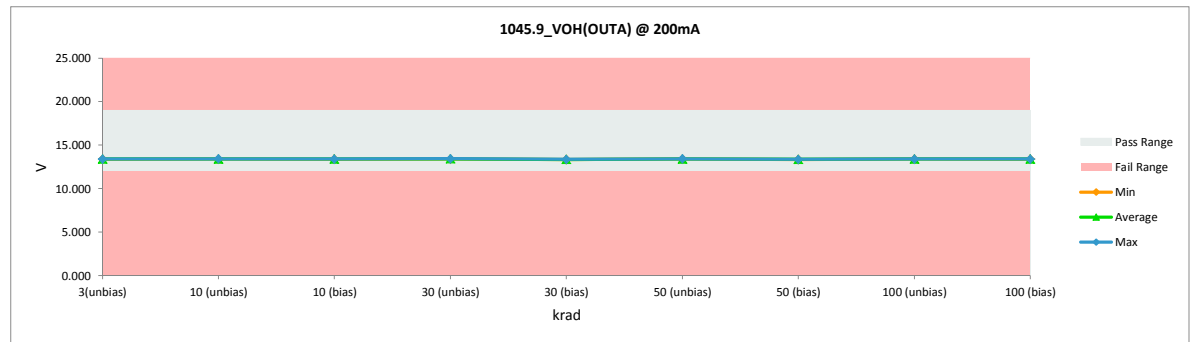

TID Report  
5962R8768106VYC

100	155	13.408	13.404	0.004
100	156	13.406	13.400	0.006
100	157	13.405	13.399	0.006
100	158	13.402	13.397	0.005
102	210	13.406	13.399	0.007
102	211	13.398	13.389	0.008
102	214	13.405	13.397	0.008
102	220	13.389	13.383	0.005
102	228	13.411	13.403	0.008
	Max	13.411	13.439	0.063
	Average	13.401	13.392	0.010
	Min	13.388	13.340	-0.043
	Std Dev	0.005	0.019	0.020

TID Report  
5962R8768106VYC

1045.10_VOH(OUTB) @ 20mA		
Test Site	Junkins	Junkins
Tester	FETS01	FETS01
Test Number	EF066700	EF066700
Unit	V	V
Max Limit	19	19
Min Limit	13	13

krad	Serial #	PRERLAT	POSTRLAT	Delta
3	42	13.552	13.546	0.005
3	43	13.552	13.549	0.003
3	47	13.551	13.551	0.000
3	50	13.547	13.545	0.003
3	53	13.560	13.559	0.001
10	54	13.560	13.559	0.001
10	55	13.555	13.553	0.002
10	56	13.553	13.564	-0.010
10	57	13.550	13.553	-0.003
10	58	13.557	13.559	-0.002
12	173	13.555	13.549	0.006
12	176	13.560	13.551	0.009
12	179	13.555	13.544	0.011
12	180	13.547	13.537	0.010
12	181	13.561	13.556	0.005
30	61	13.557	13.556	0.002
30	62	13.556	13.555	0.001
30	63	13.547	13.547	0.000
30	65	13.555	13.608	-0.052
30	67	13.555	13.566	-0.011
32	182	13.555	13.528	0.027
32	183	13.560	13.521	0.039
32	184	13.561	13.544	0.017
32	185	13.559	13.523	0.036
32	186	13.561	13.535	0.026
50	69	13.556	13.558	-0.002
50	70	13.561	13.562	0.000
50	72	13.555	13.556	-0.001
50	73	13.549	13.554	-0.005
50	74	13.558	13.566	-0.008
52	187	13.559	13.496	0.063
52	192	13.564	13.508	0.056
52	193	13.556	13.518	0.038
52	195	13.563	13.518	0.045
52	196	13.562	13.515	0.047
100	86	13.554	13.552	0.002
100	87	13.560	13.558	0.002
100	89	13.559	13.556	0.004
100	91	13.562	13.559	0.002
100	92	13.559	13.557	0.002
100	93	13.561	13.558	0.003
100	95	13.558	13.556	0.001
100	97	13.552	13.549	0.002
100	99	13.557	13.554	0.003
100	100	13.559	13.557	0.002
100	102	13.559	13.558	0.001
100	103	13.557	13.555	0.003
100	104	13.560	13.558	0.002
100	106	13.554	13.552	0.003
100	108	13.560	13.557	0.003
100	109	13.553	13.550	0.003
100	153	13.557	13.555	0.002
100	154	13.560	13.558	0.002

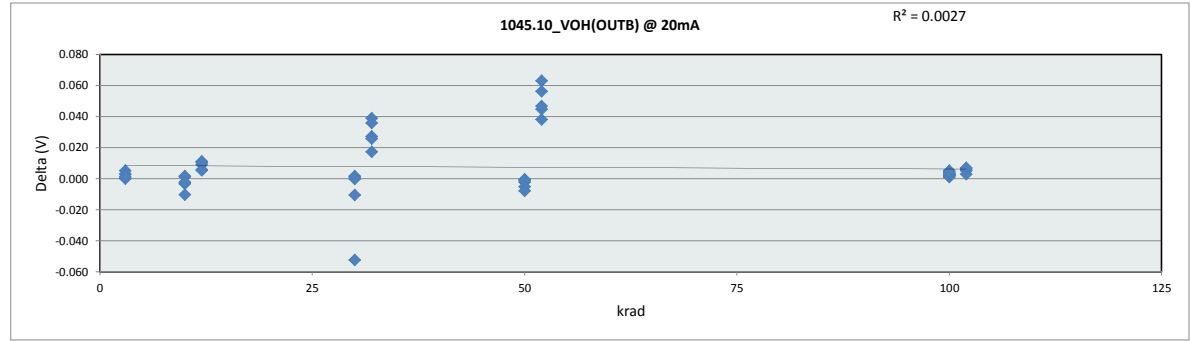

1045.10_VOH(OUTB) @ 20mA		
Test Site	Junkins	Junkins
Tester	FETS01	FETS01
Test Number	EF066700	EF066700
Max Limit	19	V
Min Limit	13	V

krad	3(unbias)	10(unbias)	10(bias)	30(unbias)	30(bias)	50(unbias)	50(bias)	100(unbias)	100(bias)
LL	13.000	13.000	13.000	13.000	13.000	13.000	13.000	13.000	13.000
Min	13.545	13.553	13.537	13.547	13.521	13.554	13.496	13.549	13.544
Average	13.550	13.558	13.547	13.566	13.530	13.559	13.511	13.556	13.553
Max	13.559	13.564	13.556	13.608	13.544	13.566	13.518	13.559	13.560
UL	19.000	19.000	19.000	19.000	19.000	19.000	19.000	19.000	19.000

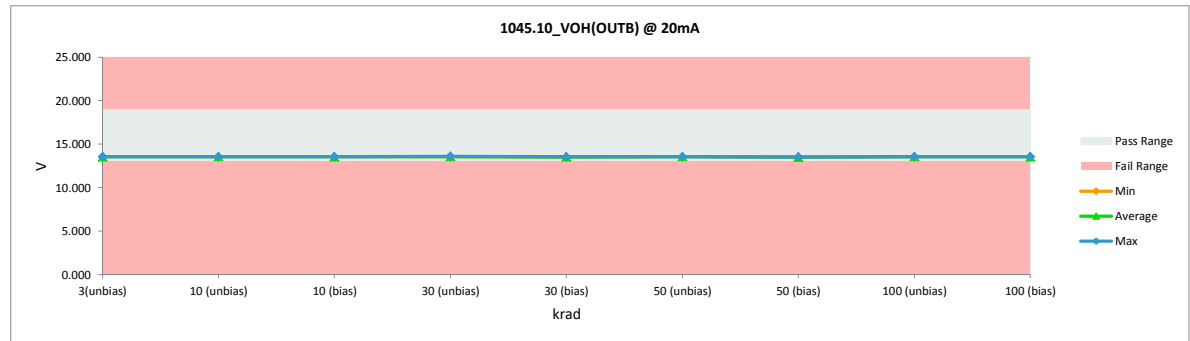



TID Report  
5962R8768106VYC

100	155	13.562	13.559	0.003
100	156	13.561	13.556	0.005
100	157	13.560	13.556	0.004
100	158	13.557	13.552	0.004
102	210	13.561	13.556	0.005
102	211	13.555	13.549	0.006
102	214	13.560	13.555	0.005
102	220	13.547	13.544	0.003
102	228	13.567	13.560	0.007
	Max	13.567	13.608	0.063
	Average	13.557	13.550	0.007
	Min	13.547	13.496	-0.052
	Std Dev	0.004	0.016	0.017

# TID Report

## 5962R8768106VYC

1045.11_VOH(OUTB) @ 200mA		
Test Site	Junkins	Junkins
Tester	FETS01	FETS01
Test Number	EF066700	EF066700
Unit	V	V
Max Limit	19	19
Min Limit	12	12

krad	Serial #	PRERLAT	POSTRLAT	Delta
3	42	13.405	13.399	0.006
3	43	13.405	13.401	0.004
3	47	13.402	13.401	0.000
3	50	13.399	13.396	0.003
3	53	13.415	13.414	0.001
10	54	13.413	13.411	0.002
10	55	13.409	13.408	0.001
10	56	13.407	13.418	-0.011
10	57	13.403	13.406	-0.003
10	58	13.410	13.415	-0.004
12	173	13.410	13.405	0.006
12	176	13.413	13.404	0.009
12	179	13.410	13.400	0.010
12	180	13.398	13.389	0.010
12	181	13.418	13.413	0.005
30	61	13.413	13.411	0.002
30	62	13.410	13.408	0.002
30	63	13.400	13.400	0.000
30	65	13.409	13.456	-0.046
30	67	13.412	13.421	-0.008
32	182	13.410	13.384	0.025
32	183	13.415	13.380	0.035
32	184	13.418	13.402	0.016
32	185	13.415	13.382	0.033
32	186	13.417	13.394	0.023
50	69	13.410	13.410	0.000
50	70	13.415	13.413	0.001
50	72	13.409	13.409	0.000
50	73	13.403	13.406	-0.004
50	74	13.415	13.420	-0.006
52	187	13.414	13.356	0.058
52	192	13.420	13.369	0.052
52	193	13.409	13.374	0.035
52	195	13.418	13.377	0.041
52	196	13.416	13.372	0.044
100	86	13.408	13.406	0.003
100	87	13.417	13.413	0.004
100	89	13.414	13.409	0.005
100	91	13.418	13.415	0.004
100	92	13.415	13.411	0.004
100	93	13.419	13.414	0.004
100	95	13.413	13.410	0.003
100	97	13.406	13.402	0.004
100	99	13.411	13.408	0.003
100	100	13.416	13.413	0.003
100	102	13.415	13.411	0.003
100	103	13.411	13.407	0.004
100	104	13.414	13.410	0.004
100	106	13.408	13.405	0.003
100	108	13.415	13.411	0.004
100	109	13.407	13.403	0.004
100	153	13.411	13.407	0.004
100	154	13.416	13.413	0.003

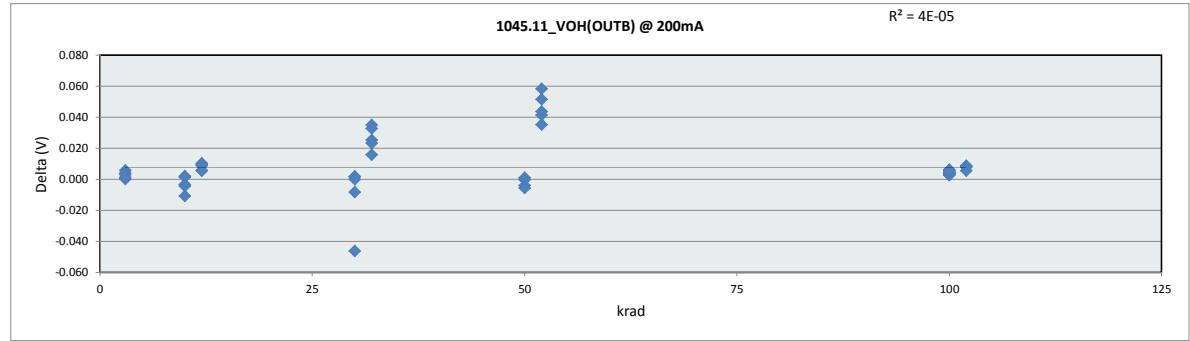

1045.11_VOH(OUTB) @ 200mA		
Test Site	Junkins	Junkins
Tester	FETS01	FETS01
Test Number	EF066700	EF066700
Max Limit	19	V
Min Limit	12	V

krad	3(unbias)	10(unbias)	10(bias)	30(unbias)	30(bias)	50(unbias)	50(bias)	100(unbias)	100(bias)
LL	12.000	12.000	12.000	12.000	12.000	12.000	12.000	12.000	12.000
Min	13.396	13.407	13.389	13.400	13.380	13.407	13.356	13.402	13.395
Average	13.402	13.412	13.402	13.419	13.388	13.412	13.370	13.409	13.405
Max	13.414	13.418	13.413	13.456	13.402	13.420	13.377	13.415	13.414
UL	19.000	19.000	19.000	19.000	19.000	19.000	19.000	19.000	19.000

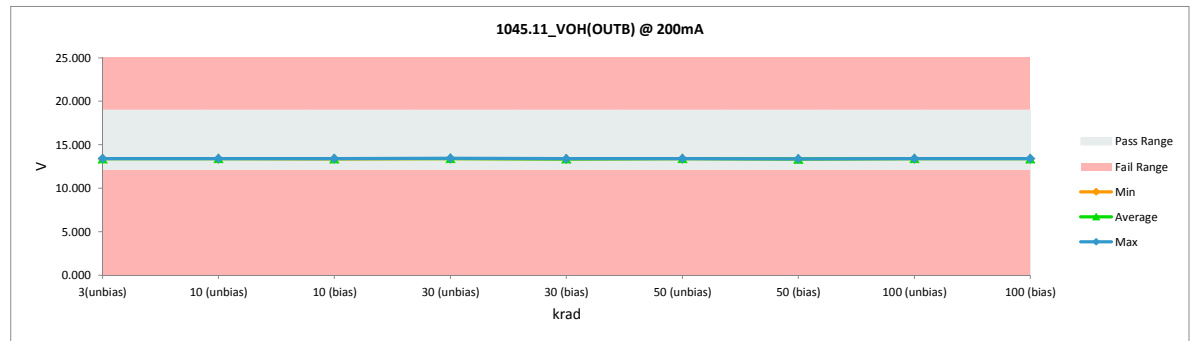

TID Report  
5962R8768106VYC

100	155	13.419	13.414	0.005
100	156	13.415	13.409	0.006
100	157	13.415	13.409	0.006
100	158	13.411	13.406	0.005
102	210	13.417	13.409	0.008
102	211	13.408	13.400	0.009
102	214	13.416	13.408	0.008
102	220	13.400	13.395	0.005
102	228	13.423	13.414	0.009
	Max	13.423	13.456	0.058
	Average	13.412	13.404	0.008
	Min	13.398	13.356	-0.046
	Std Dev	0.006	0.015	0.015

## IMPORTANT NOTICE AND DISCLAIMER

TI PROVIDES TECHNICAL AND RELIABILITY DATA (INCLUDING DATASHEETS), DESIGN RESOURCES (INCLUDING REFERENCE DESIGNS), APPLICATION OR OTHER DESIGN ADVICE, WEB TOOLS, SAFETY INFORMATION, AND OTHER RESOURCES "AS IS" AND WITH ALL FAULTS, AND DISCLAIMS ALL WARRANTIES, EXPRESS AND IMPLIED, INCLUDING WITHOUT LIMITATION ANY IMPLIED WARRANTIES OF MERCHANTABILITY, FITNESS FOR A PARTICULAR PURPOSE OR NON-INFRINGEMENT OF THIRD PARTY INTELLECTUAL PROPERTY RIGHTS.

These resources are intended for skilled developers designing with TI products. You are solely responsible for (1) selecting the appropriate TI products for your application, (2) designing, validating and testing your application, and (3) ensuring your application meets applicable standards, and any other safety, security, or other requirements. These resources are subject to change without notice. TI grants you permission to use these resources only for development of an application that uses the TI products described in the resource. Other reproduction and display of these resources is prohibited. No license is granted to any other TI intellectual property right or to any third party intellectual property right. TI disclaims responsibility for, and you will fully indemnify TI and its representatives against, any claims, damages, costs, losses, and liabilities arising out of your use of these resources.

TI's products are provided subject to TI's Terms of Sale ([www.ti.com/legal/termsofsale.html](http://www.ti.com/legal/termsofsale.html)) or other applicable terms available either on [ti.com](http://ti.com) or provided in conjunction with such TI products. TI's provision of these resources does not expand or otherwise alter TI's applicable warranties or warranty disclaimers for TI products.

Mailing Address: Texas Instruments, Post Office Box 655303, Dallas, Texas 75265  
Copyright © 2019, Texas Instruments Incorporated