

User's Guide
DRV8300xxx-EVM User's Guide



ABSTRACT

This document is provided with the DRV8300Dxxx-EVM customer evaluation module (EVM) as a supplement to the DRV8300 Datasheet. This user's guide details the hardware implementation of the EVM.

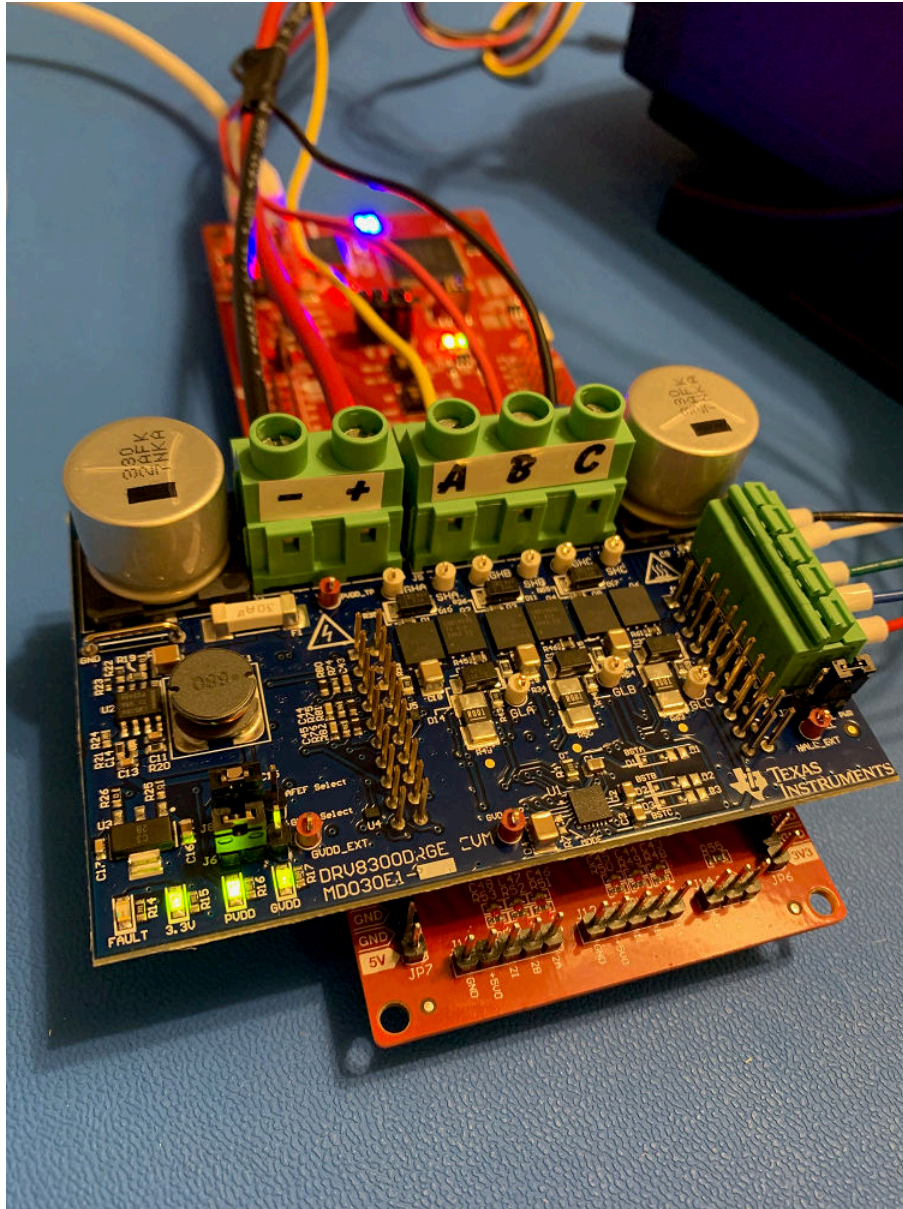

Figure 1-1. DRV8300Dxxx-EVM

CAUTION

The DRV8300Dxxx-EVMs are designed to be evaluated only with the LAUNCHXL-F280049C MCU PCB which must be ordered separately.

The 3.3V_{DC} power to the LAUNCHXL-F280049C is provided from the DRV8300Dxxx-EVM.

To ensure high voltage isolation between the DRV8300Dxxx-EVM and the LAUNCHXL-F280049C board, the three isolation jumpers must be removed as shown below.

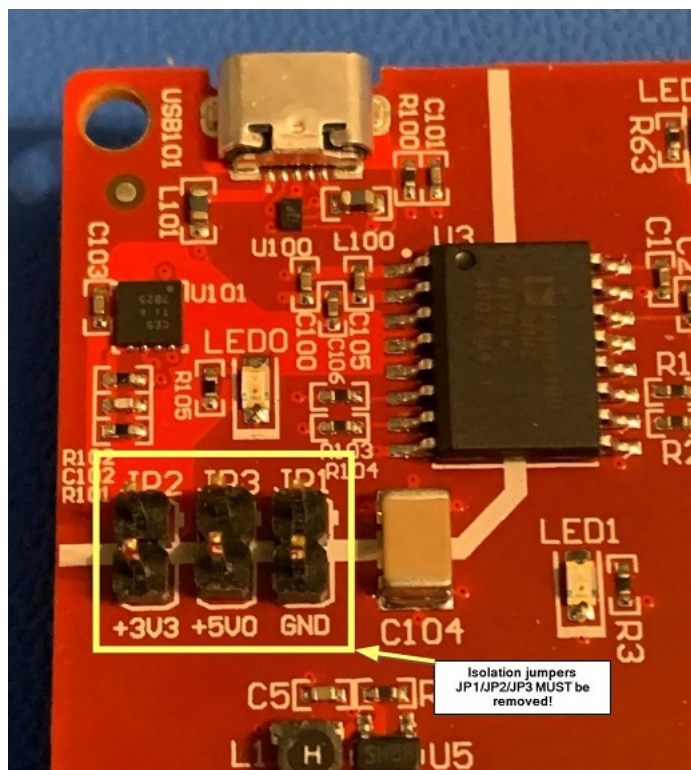

Figure 1-2. JP1/JP2/JP3 Removed

WARNING

Although the MCU PCB provides isolation of up to 3000 V_{RMS} to the USB, the DRV8300Dxxx-EVM itself is considered an electrically live EVM and is not intended nor designed for isolation voltage testing. Voltages exceeding the standard EVM ratings as specified on the data sheet may cause personal injury, electrical shock hazard, damage the EVM, or a combination.

Additionally, do not leave power connections to the EVM connected while not in operation.

WARNING



Hot surface. Contact may cause burns. Do not touch.

WARNING

High Voltage. Electric shock is possible when connecting board to live wire. The board should be handled with care by a professional.

For safety, use of isolated test equipment with overvoltage and overcurrent protection is highly recommended.

Table of Contents

1 Introduction	4
1.1 Overview.....	4
1.2 Purpose and Scope.....	4
2 Hardware and Software Overview	5
2.1 Hardware Connections Overview – DRV8300Dxxx-EVM + LAUNCHXL-F280049C.....	5
2.2 Faults, Indicators, and Jumper Settings.....	8
2.3 EVM Hardware Quick-Start.....	9
2.4 DRV8300 EVM GUI Software.....	10
3 References	12

List of Figures

Figure 1-1. DRV8300Dxxx-EVM.....	1
Figure 1-2. JP1/JP2/JP3 Removed.....	2
Figure 1-1. Block Diagram.....	4
Figure 2-1. EVM Board Overview.....	5
Figure 2-2. DRV8300Dxxx-EVM Mating to LAUNCHXL-F280049C.....	6
Figure 2-3. PVDD Input (J4).....	6
Figure 2-4. Hall Sensor Input and Power Connections (J7).....	7
Figure 2-5. Motor Phase Connector (J5).....	8
Figure 2-6. Status LEDs, AREF Select, and GVDD Select.....	9
Figure 2-7. DRV8300Dxxx-EVM GUI Software.....	10

List of Tables

1 Introduction

1.1 Overview

The DRV8300 is a gate driver IC for three-phase motor drive applications. It provides three high-accuracy trimmed and temperature compensated half-bridge drivers, each capable of driving high-side and low-side N-type MOSFETs.

Along with the hardware of the DRV8300, the [TMS320F280049C](#) microcontroller-based board has reference software that sends necessary signals to the DRV8300 to spin a 3-phase Brushless-DC motor. GuiComposer software allows the user to program settings, enable the motor to spin, and monitor the system from fault conditions.

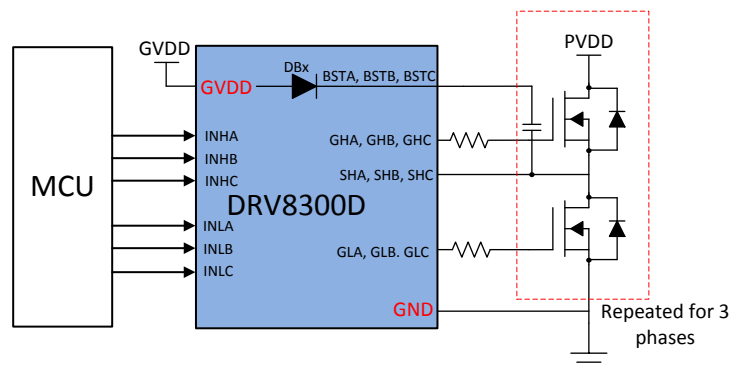

Figure 1-1. Block Diagram

1.2 Purpose and Scope

This document is designed to be used as a startup guide to the DRV8300 EVM and LAUNCHXL-F280049C solution. This document is intended for the engineers involved in the design, implementation, and validation of DRV8300 + TMS320F280049C reference software.

The scope of this document is to provide the user with a guide to evaluate the DRV8300 device with a TMS320F280049C isolated board. This document covers the hardware connections required between boards and external motor/supplies. When the hardware connections are complete, the user is required to download the necessary tools and software to spin a motor.

The reference software is composed of GuiComposer software with sensored trapezoidal algorithm for BLDC motor control.

2 Hardware and Software Overview

2.1 Hardware Connections Overview – DRV8300Dxxx-EVM + LAUNCHXL-F280049C

The following section describes the EVM hardware and connections to the external supply, hall sensors, PC via USB, and motor.

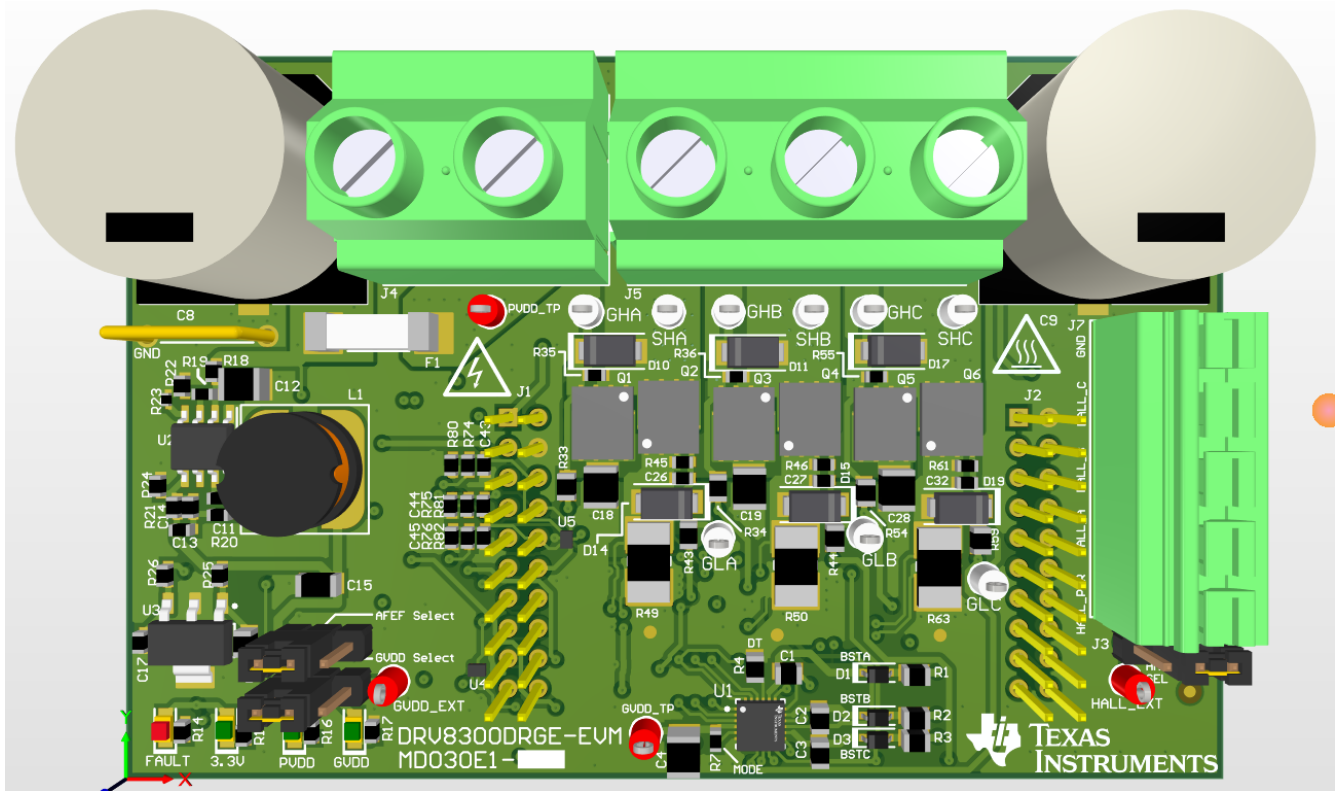

Figure 2-1. EVM Board Overview

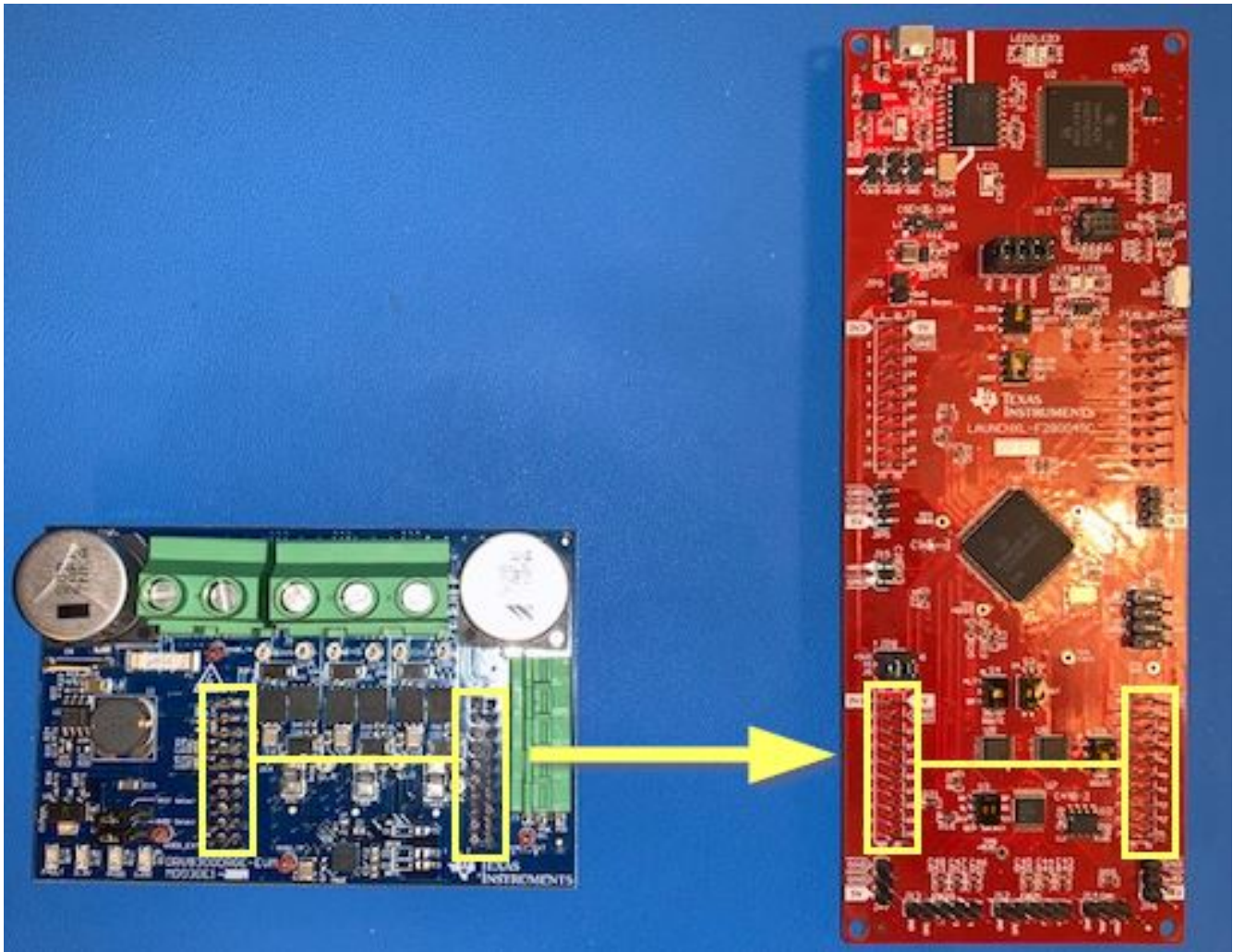

Figure 2-2. DRV8300Dxxx-EVM Mating to LAUNCHXL-F280049C

The DRV8300Dxxx-EVM must plug into the lower LAUNCHXL-F280049C Launchpad headers as shown below.

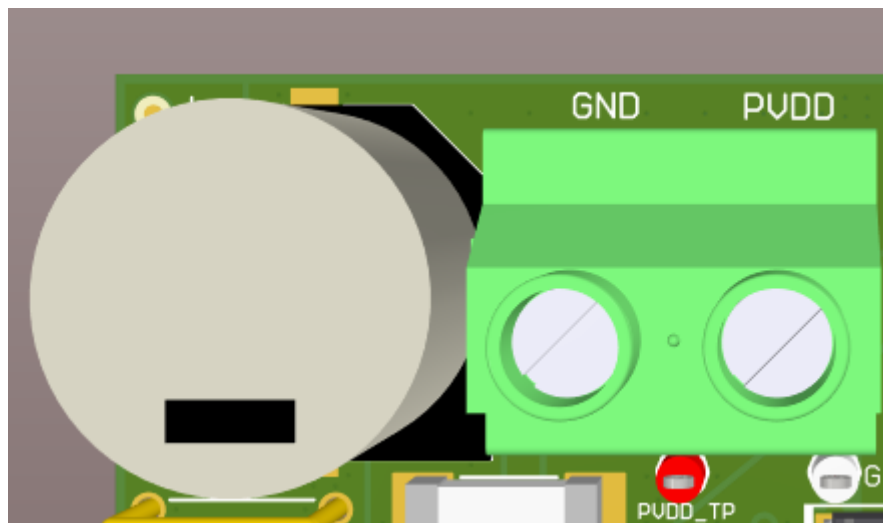

Figure 2-3. PVDD Input (J4)

WARNING

To minimize the risk of potential shock hazard and personal injury, remove all power connections and interfaces to the DRV8300Dxxx-EVM when not in use.

The DRV8300Dxxx-EVM is designed for an input supply from 6 V_{DC} to 100 V_{DC} and up to 25-A continuous drive current (software limited). The input connects to J4 with the noted polarity. PVDD_TP connects to the same node but must not be used for high current input. PVDD input is fused with a 30 A fuse and the input connector is rated for 32 A.

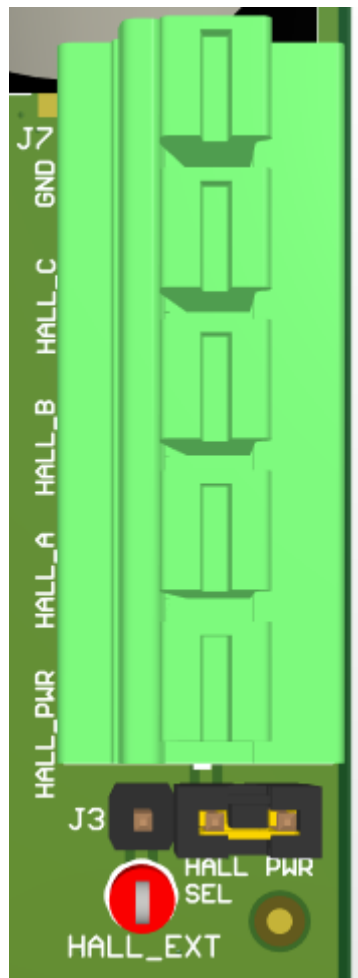

Figure 2-4. Hall Sensor Input and Power Connections (J7)

Hall sensors are connected to J7 including hall power and GND. The 3.3 V_{DC} supply to the Hall sensors is supplied from the 3.3 V LDO on the EVM. External hall power can be input through the HALL_EXT test point if a different supply or voltage level is desired. To use the included 3.3 V LDO to power the halls, connect J3 on the right side to pins 1:2 as shown. To use HALL_EXT, connect J3 on the left side to pins 2:3. To insert or remove wires/terminals on J7, use a flat blade screwdriver to push down the respective tab on top of the J7 connector.



Figure 2-5. Motor Phase Connector (J5)

WARNING

Motor Phase connections must match the hall sensor connection sequence. For example, MOTA must match HALL_A, MOTB must match HALL_B, MOTC must match HALL_C. The phases must also be in sequential order; A, then B, then C.

If the motor phases do not match the hall sensors or the connections are made out of order, the motor will not spin smoothly and current consumption will increase.

The three phase inputs of the motor connect to MOTA/MOTB/MOTC through connector J5.

2.2 Faults, Indicators, and Jumper Settings

The DRV8300 implements Bootstrap Undervoltage, GVDD Undervoltage, and Thermal Shutdown in case of overtemperature. See the DRV8300 Datasheet for more information on DRV8300 fault support.

The DRV8300Dxxx-EVM implements Overvoltage and Undervoltage on the PVDD and GVDD supplies as well as Gross Over-Current protection. Status LEDs for the 3.3 V, PVDD, GVDD, and FAULT are included and shown below.

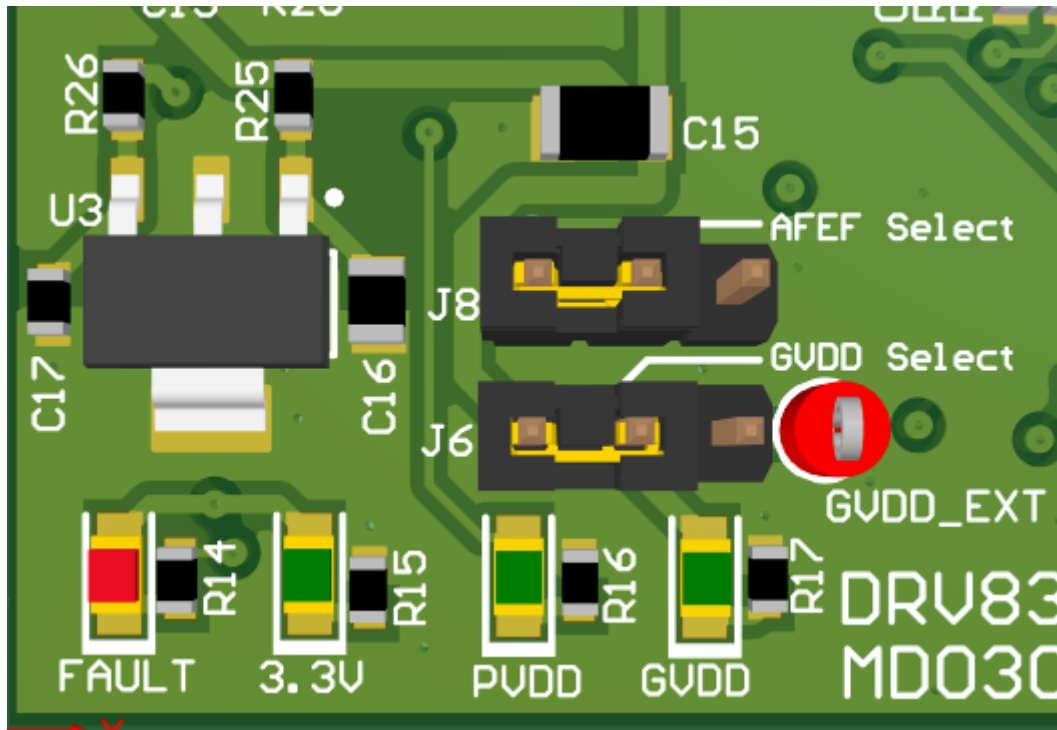

Figure 2-6. Status LEDs, AREF Select, and GVDD Select

The FAULT LED will light up if the EVM senses a fault due to the following conditions:

FAULT	Lower Limit	Upper Limit	Action Taken
PVDD	6 V	100 V	PWM Input forced to 0%.
GVDD	6 V	20 V	PWM Input forced to 0%.
Over-Current	-25 A	25 A	PWM Input forced to 0%.

The Faults can be reset in the GUI software using the CLEAR FAULTS button. More details on the GUI can be found in the Software section below.

The AREF Select jumper selects the offset for the Current Shunt Amplifiers on the EVM. The default position is to the left on pins 1:2 which configures the CSA for Bi-directional mode (offset 1.65 V) allowing the CSA input to sense positive or negative current. Placing the jumper to the right on pins 2:3 configures the CSA for Unidirectional mode (offset 0 V) which allows only positive currents to be measured. This does increase the measurement range of the CSA.

The GVDD Select jumper allows the user to use the built-in 12 V Buck Regulator to generate GVDD or input it externally through GVDD_EXT. The default position is to the left on pins 1:2 which configures the EVM for internal mode (GVDD from the buck regulator). Placing the jumper to the right on pins 2:3 configures the board for external GVDD mode (GVDD supplied into GVDD_EXT test point).

2.3 EVM Hardware Quick-Start

This section describes the steps to prepare the DRV8300Dxxx-EVM for first motor spin-up. This section assumes the default jumper positions mentioned above are used.

1. **Ensure that the isolation jumpers JP1/JP2/JP3 on the LAUNCHXL-F280049C have been removed.**
2. Plug the DRV8300Dxxx-EVM onto the lower position of the LAUNCHXL-F280049C board.
3. Connect motor phase connections to their respective MOTA/MOTB/MOTC inputs on J5, making sure to match A, B, and C.

4. Connect the Hall sensor connections, Hall power, and ground to J7. Make sure that Hall A, B, and C are in the correct order.
5. Connect the provided micro-USB cable to the LAUNCHXL-F280049C.
6. Connect PVDD and GND to connector J4. A low current limit of 300 mA on the PVDD supply is recommended for first power-up to ensure the EVM is connected correctly. If there is no issue upon power-up, the current limit can be raised to allow for current based on your motor specifications.
7. Start the GUI per the instructions below in the software section.

2.4 DRV8300 EVM GUI Software

This section details the features of the EVM GUI Software. The GUI is written in GUI Composer and is available on the development software gallery at dev.ti.com/gallery. Once logged into the TI system, if you cannot find the GUI you may need to request access from your TI representative.

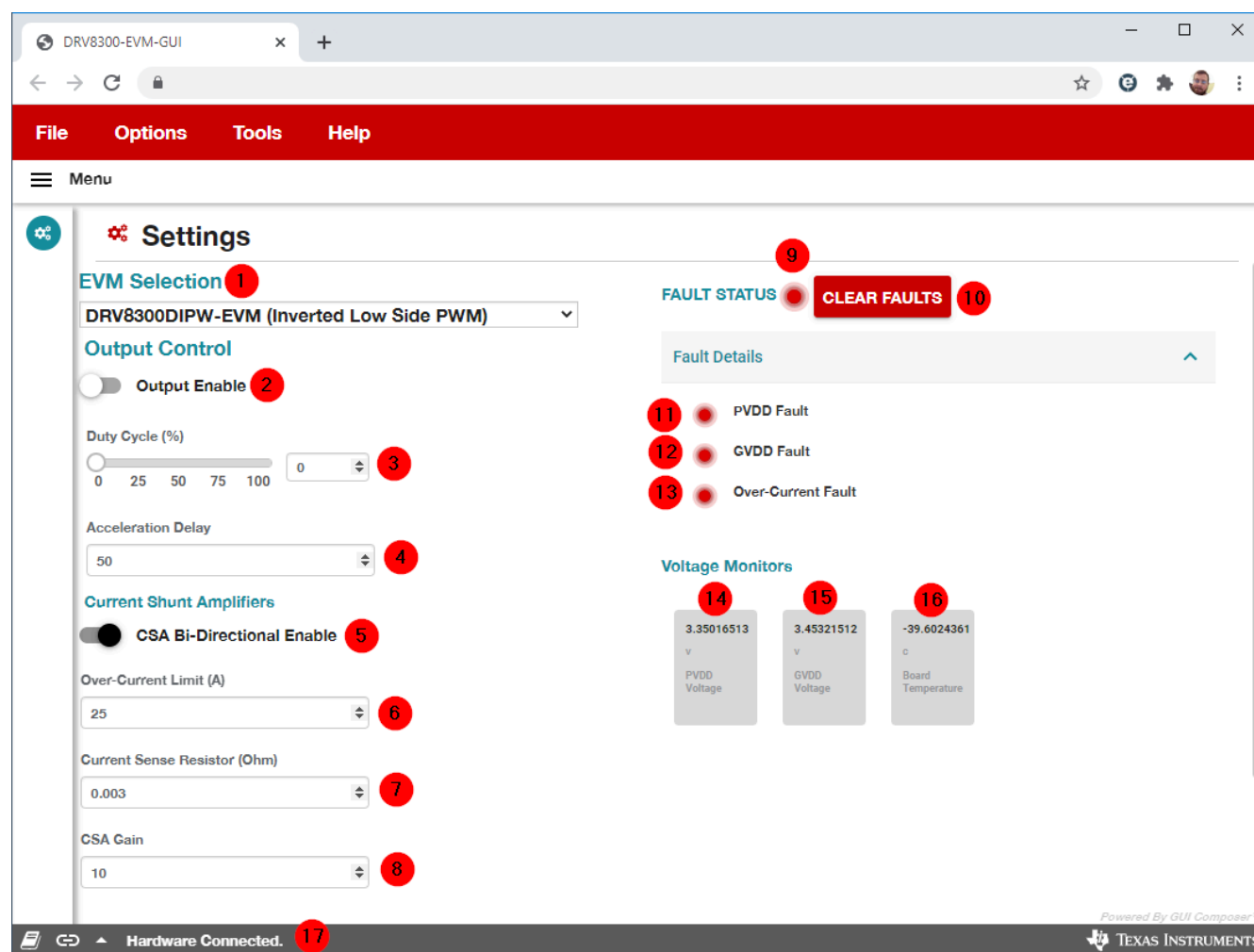

Figure 2-7. DRV8300Dxxx-EVM GUI Software

The GUI will Connect to and program the C2000 MCU on the LAUNCHXL-F280049C board when launched assuming the board is connected/powered.

The GUI includes the following indicators and controls:

Item #	Item Name	Item Description
1	EVM Selection	Select the EVM connected to the PC, either DRGE or DIPW.

Item #	Item Name	Item Description
2	Output Enable	This will enable or disable the Duty Cycle slider. When disabled, the Duty Cycle is automatically set to 0%.
3	Duty Cycle %	This controls the Duty Cycle % input sent to the DRV8300. Note that the PWM frequency is fixed at 20 kHz.
4	Acceleration Delay	Number of processing cycles to skip in each update of the PWM and GUI controls. Increase this for slower PWM update rate or decrease for faster PWM update rate.
5	CSA Bi-Directional Enable	Enabled by default, this controls the software offset for the CSA. This should match the selection of jumper J8.
6	Over-Current Limit	Software Over-Current limit for gross overcurrent detection and Fault.
7	Current Sense Resistor	Current sense resistor value populated on board, default is 0.003 ohms.
8	CSA Gain	CSA gain resistor setting, hardware resistor, default 10 V/V.
9	Fault Status LED	Indicator for overall Fault status. Logical OR of all faults.
10	CLEAR FAULTS	Click this button to clear the Fault warning. If the Fault persists, this control will not disable or clear the Faults.
11	PVDD Fault LED	Indicates a PVDD fault has occurred, either overvoltage or undervoltage.
12	GVDD Fault LED	Indicates a GVDD fault has occurred, either overvoltage or undervoltage.
13	Over-Current Fault LED	Indicates a gross Over-Current fault has occurred. Limit is set by control (5).
14	PVDD Voltage Indicator	PVDD voltage sensed by the MCU.
15	GVDD Voltage Indicator	GVDD voltage sensed by the MCU.
16	Board Temperature	Temperature sensor on the bottom of the PCB located under the FETs.
17	Connection Status and Control	Displays if the GUI is connected to the hardware.

Once the hardware is connected, the FAULT Status and Voltage Monitors should match the EVM. If these do not match then please remove EVM power and recheck the setup.

To spin the motor:

1. Use the EVM Selection drop down to select which EVM is connected to the PC, either DIPW or DRGE.
2. Enable the PWM using the Output Enable toggle switch.
3. Use the Duty Cycle slider or input field to change the PWM Input Duty Cycle.
4. The motor should now be spinning!

3 References

See these documents for additional reference:

- Texas Instruments, [DRV8300 Datasheet](#)
- Texas Instruments, [TMS320F280049C Product Page](#)
- Texas Instruments, [LAUNCHXL-F280049C Product Page](#)

IMPORTANT NOTICE AND DISCLAIMER

TI PROVIDES TECHNICAL AND RELIABILITY DATA (INCLUDING DATA SHEETS), DESIGN RESOURCES (INCLUDING REFERENCE DESIGNS), APPLICATION OR OTHER DESIGN ADVICE, WEB TOOLS, SAFETY INFORMATION, AND OTHER RESOURCES "AS IS" AND WITH ALL FAULTS, AND DISCLAIMS ALL WARRANTIES, EXPRESS AND IMPLIED, INCLUDING WITHOUT LIMITATION ANY IMPLIED WARRANTIES OF MERCHANTABILITY, FITNESS FOR A PARTICULAR PURPOSE OR NON-INFRINGEMENT OF THIRD PARTY INTELLECTUAL PROPERTY RIGHTS.

These resources are intended for skilled developers designing with TI products. You are solely responsible for (1) selecting the appropriate TI products for your application, (2) designing, validating and testing your application, and (3) ensuring your application meets applicable standards, and any other safety, security, regulatory or other requirements.

These resources are subject to change without notice. TI grants you permission to use these resources only for development of an application that uses the TI products described in the resource. Other reproduction and display of these resources is prohibited. No license is granted to any other TI intellectual property right or to any third party intellectual property right. TI disclaims responsibility for, and you will fully indemnify TI and its representatives against, any claims, damages, costs, losses, and liabilities arising out of your use of these resources.

TI's products are provided subject to [TI's Terms of Sale](#) or other applicable terms available either on ti.com or provided in conjunction with such TI products. TI's provision of these resources does not expand or otherwise alter TI's applicable warranties or warranty disclaimers for TI products.

TI objects to and rejects any additional or different terms you may have proposed.

Mailing Address: Texas Instruments, Post Office Box 655303, Dallas, Texas 75265
Copyright © 2022, Texas Instruments Incorporated