

TLC5540/TLC5510/TLC5510A

Evaluation Module

User's Guide

IMPORTANT NOTICE

Texas Instruments Incorporated and its subsidiaries (TI) reserve the right to make corrections, modifications, enhancements, improvements, and other changes to its products and services at any time and to discontinue any product or service without notice. Customers should obtain the latest relevant information before placing orders and should verify that such information is current and complete. All products are sold subject to TI's terms and conditions of sale supplied at the time of order acknowledgment.

TI warrants performance of its hardware products to the specifications applicable at the time of sale in accordance with TI's standard warranty. Testing and other quality control techniques are used to the extent TI deems necessary to support this warranty. Except where mandated by government requirements, testing of all parameters of each product is not necessarily performed.

TI assumes no liability for applications assistance or customer product design. Customers are responsible for their products and applications using TI components. To minimize the risks associated with customer products and applications, customers should provide adequate design and operating safeguards.

TI does not warrant or represent that any license, either express or implied, is granted under any TI patent right, copyright, mask work right, or other TI intellectual property right relating to any combination, machine, or process in which TI products or services are used. Information published by TI regarding third-party products or services does not constitute a license from TI to use such products or services or a warranty or endorsement thereof. Use of such information may require a license from a third party under the patents or other intellectual property of the third party, or a license from TI under the patents or other intellectual property of TI.

Reproduction of information in TI data books or data sheets is permissible only if reproduction is without alteration and is accompanied by all associated warranties, conditions, limitations, and notices. Reproduction of this information with alteration is an unfair and deceptive business practice. TI is not responsible or liable for such altered documentation.

Resale of TI products or services with statements different from or beyond the parameters stated by TI for that product or service voids all express and any implied warranties for the associated TI product or service and is an unfair and deceptive business practice. TI is not responsible or liable for any such statements.

Mailing Address:

Texas Instruments
Post Office Box 655303
Dallas, Texas 75265

Read This First

About This Manual

This user's guide serves as a reference book for the TLC5540/TLC5510/TLC5510A. This document provides information to assist managers and hardware/software engineers in application development.

How to Use This Manual

This document contains the following chapters:

- Chapter 1 Overview
- Chapter 2 Circuit Description
- Chapter 3 Physical Description

Information About Cautions and Warnings

This book may contain cautions and warnings.

This is an example of a caution statement.

A caution statement describes a situation that could potentially damage your software or equipment.

This is an example of a warning statement.

A warning statement describes a situation that could potentially cause harm to you.

The information in a caution or a warning is provided for your protection. Please read each caution and warning carefully.

Related Documentation From Texas Instruments

The following documents may be ordered by contacting the Texas Instruments Product Information Center at one of the numbers listed on the next page, or, they may be downloaded at:

<http://www-s.ti.com/sc/docs/psheets/pids2.htm>

TLC5510/TLC5510A Data Sheet (literature number SLAS095) contains electrical specifications, available temperature options, general overview of the device, and application information.

TLC5540 Data Sheet (literature number SLAS105) contains electrical specifications, available temperature options, general overview of the device, and application information.

CE/FCC Warnings

This equipment is intended for use in a laboratory test environment only. It generates, uses, and can radiate radio frequency energy and has not been tested for compliance with the limits of computing devices pursuant to subpart J of part 15 of FCC rules. This device has been tested and found to comply with the limits for a CISPR II Group 1 and the following directives: EMC Directive 89/336/EEC amending directive 92/31/EEC and 93/68/EEC as per ENV50204:1995, EN55011: 1995 Class A, EN61000-4-4: 1995, and EN6100-4-3: 1993. Operation of this equipment in other environments may cause interference with radio communications, in which case the user at his own expense will be required to take whatever measures may be required to correct this interference.

Contents

| | | |
|----------|------------------------------------|------------|
| 1 | Overview | 1-1 |
| 1.1 | Purpose | 1-2 |
| 1.2 | Power Supply Requirements | 1-2 |
| 2 | Circuit Description | 2-1 |
| 2.1 | EVM Analog Input | 2-2 |
| 2.1.1 | Direct Input | 2-2 |
| 2.1.2 | Amplifier Input, DC-Coupled | 2-2 |
| 2.1.3 | Amplifier Input, AC-Coupled | 2-3 |
| 2.1.4 | Input Bias Operational Range | 2-3 |
| 2.1.5 | Test Points | 2-3 |
| 2.1.6 | User Supplied Input Circuit | 2-4 |
| 2.2 | Digital Output | 2-4 |
| 2.3 | Clock Circuit | 2-4 |
| 2.4 | Board Schematic | 2-4 |
| 3 | Physical Description | 3-1 |
| 3.1 | Board Layout | 3-2 |
| 3.2 | Board Layers | 3-3 |
| 3.3 | Part Descriptions | 3-7 |

Figures

| | | |
|-----|-------------------------|-----|
| 2-1 | Board Schematic | 2-5 |
| 3-1 | EVM Board Layout | 3-2 |
| 3-2 | EVM Board Layer 1 | 3-3 |
| 3-3 | EVM Board Layer 2 | 3-4 |
| 3-4 | EVM Board Layer 3 | 3-5 |
| 3-5 | EVM Board Layer 4 | 3-6 |

Tables

| | | |
|-----|--------------------------------|-----|
| 1-1 | Power Supplies | 1-2 |
| 2-1 | Amplifier Input Coupling | 2-3 |
| 2-2 | Input Voltage Setting | 2-3 |
| 2-3 | Test Points | 2-4 |
| 3-1 | Part Descriptions | 3-7 |

Overview

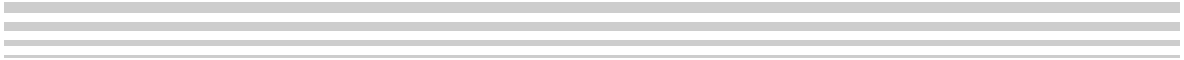

This chapter gives an overview of the TLC5540/TLC5510/TLC5510A evaluation module (EVM).

| Topic | Page |
|-------------------------------------|-------------|
| 1.1 Power Supply Requirements | 1-2 |
| 1.2 Power Supply Requirements | 1-2 |

1.1 Purpose

The TLC5540/TLC5510/TLC5510A evaluation module (EVM) provides a platform for lab prototype evaluation of the Texas Instruments TLC5540/TLC5510/TLC5510A 8-bit, high-speed analog-to-digital converters.

Since practical operation can be achieved with a clock speed in excess of 40 MHz, the circuit layout is critical and does not lend itself to classic breadboarding techniques. In fact, proper operation requires use of surface-mount components.

1.2 Power Supply Requirements

The TLC5540/TLC5510/TLC5510A EVM is designed to be powered by regulated lab power supplies. Three lab supplies are required for the best performance.

Table 1–1. Power Supplies

| Connector | Supply | If Amp Used | By-pass Amp |
|-----------|------------------------|--------------------|--------------------|
| | | TLC5540/5510/5510A | TLC5510/5540/5510A |
| J2 | Positive analog supply | 5 V \pm 10% | 5 V \pm 10% |
| J3 | Negative analog supply | –5 V \pm 10% | N/A |
| J8 | Digital supply | 5 V \pm 10% | 5 V \pm 10% |

The 5 V and –5 V analog supplies share an analog ground plane. The digital supply uses an isolated ground plane.

The two ground planes can be easily connected by soldering jumpers from E21 to E22 or from E13 to E14. This allows the user to adapt the EVM to various grounding conditions that can exist in an evaluation circuit interface.

Circuit Description

This chapter describes the EVM circuit and its operation.

| Topic | Page |
|-----------------------------------|-------------|
| 2.1 EVM Analog Input | 2-2 |
| 2.2 Digital Output | 2-4 |
| 2.3 Clock Circuit | 2-4 |
| 2.4 Board Schematic | 2-4 |

2.1 EVM Analog Input

The EVM analog input signal is applied to BNC connector J4 by one of four methods:

- Direct
- Amplifier input (dc-coupled)
- Amplifier input (ac-coupled)
- User supplied input

2.1.1 Direct Input

To route the signal directly to the TLC5540/TLC5510/TLC5510A input, solder jumpers from E7 to E8 and from E23 to E12. This provides a 50- Ω load (R5) at input connector J4. The input signal must be dc-biased to the specifications defined by the data sheet. The TLC5540/TLC5510/TLC5510A is connected using its internal bias resistors. Jumper J6 bypasses one of the internal bias resistors and thus alters the input bias range required by the input signal. With J6 installed, the voltage range of the TLC5540/TLC5510 is 0 V to 2.28 V (at 3.3 V_{DDA}).

The TLC5510A uses only the center internal bias resistor with an externally-applied regulated 4-V reference to generate the device reference voltage. Hence the input signal range applied to J4 can be between 0 V–4 V.

The input signal is band-limited to 12 MHz by the LC filter consisting of FB5, R15, and C5. For a bandwidth of 20 MHz, select a value for C5 in the 15 pF to 33 pF range.

2.1.2 Amplifier Input, DC-Coupled

A THS3001 high-speed transconductance operational amplifier provides buffering for dc-coupled amplifier-input signals. The amplifier circuit provides a flat response to 300 MHz with a gain of two. It can drive a low impedance load.

The values of R6 and R8 set the amplifier gain to two.

The gain can be reduced to one by removing R6. Since the inverting input is a low-impedance current-controlled input, R8 must remain in the circuit, and its value must be changed to 1 k Ω . This resistance value is critical because it controls the high frequency response of the circuit. The TLC5510A amplifier gain is set to one.

The output rolloff filter, consisting of R4 and C14, provides a small amount of filtering against frequencies in excess of 20 MHz ($f_g/2$). The value of C14 can be altered to change the filter characteristics, or C14 can be removed entirely. In most cases, R4 should be retained to lower the direct capacitive load on the operational amplifier, thereby avoiding high frequency peaking of the output signal.

Resistor R7 also provides isolation against a direct capacitive load (such as a scope probe) on the test point terminal.

The amplifier output circuit is connected to the TLC5540/TLC5510/TLC5510A by soldering a jumper between terminals E10 and E12.

The amplifier input can be either dc-coupled or ac-coupled to the ADC input. Table 2–1 shows the jumpers required to select either input coupling method.

Table 2–1. Amplifier Input Coupling

| Coupling | Jumper Terminals |
|----------|------------------|
| dc | E3 to E4 |
| ac | E1 to E2 |

2.1.3 Amplifier Input, AC-Coupled

Potentiometer R2 controls the dc input bias for amplifier ac-coupled inputs. This allows the bias to be varied from near ground to near 5 V/3.6 V (analog). With an amplifier gain of two, the output approaches the positive power supply when the bias potentiometer approaches 2.5 V for the TLC5510/TLC5540.

For a 4-V input and a gain of 1 (R6 removed and R8 set to 1 k Ω for optimum settling time and minimum ringing) bias potentiometer R2 is adjusted such that E1 is at 2 V and the amplifier output swing is 0 V to 4 V at TP2. With an amplifier supply voltage of +5 V the output positive peak will be distorted slightly; therefore, it is necessary to adjust the 5-V supply to 5.56 V in order to prevent clipping of the amplifier output voltage.

The low frequency response pole is dominated by the 4.7- μ F capacitor (C6) and the resistance setting of the potentiometer.

2.1.4 Input Bias Operational Range

Jumper J6 determines the signal input range (0 to full scale) at the analog input of the TLC5540/TLC5510/TLC5510A. Table 2–2 shows the effects of J6.

Table 2–2. Input Voltage Setting

| Jumper J6 | TLC5540/TLC5510 Input Voltage Range at 5 V _{DDA} | TLC5510A Input Voltage Range at 5 V _{DDA} |
|-----------|---|--|
| Removed | 0.6 V to 2.6 V | 0 V to 4 V (J11 and J16 installed) |
| Installed | 0 V to 2.28 V | 0 V to 4 V (J11 and J16 installed) |

Other output ranges can be configured. See the TLC5540/TLC5510/TLC5510A data sheets.

2.1.5 Test Points

Test points TP1 and TP2 provide an oscilloscope connection to monitor the output of the analog input conditioning amplifier stage as shown in Table 2–3.

Table 2–3. Test Points

| Test Point | Connection |
|------------|--------------------------|
| TP1 | Analog ground |
| TP2 | Analog output of THS3001 |

2.1.6 User Supplied Input Circuit

A breadboarding area allows the use of custom input filters or other signal conditioning circuits. To route the input signal to the breadboarding area (terminal E24), solder a jumper between terminals E5 and E6.

To route the signal from the breadboard area (terminal E25) to the TLC5540/TLC5510/TLC5510A input, solder a jumper between terminals E11 and E12.

Only one of the above configurations should be used at one time to prevent excessive capacitance on the signal path. This excessive capacitance can degrade the input signal quality at high frequencies.

2.2 Digital Output

An octal high-speed latch (U4) provides buffered digital data. The factory configuration uses this latch as a buffer to drive the 22-ohm line damping resistors.

Pin 24 on the output connector (J5) can be used to drive the U4 output to a high impedance (3-state) allowing a bus interface to external circuitry. To do so, the jumper between terminals E17 and E18 must be removed to eliminate the ground connection. Logic 1 applied to J5 pin 24 makes the latch output a 3-state output.

This latch can be transparent by using external circuitry to drive the strobe input (pin 11). The jumper at E19 and E20 must be removed and the external drive be connected to E19. A logic 0 on this input captures and holds the input data on the output. A logic 1 allows the outputs to follow the inputs.

2.3 Clock Circuit

An external clock of up to 40 MHz is required for operation. The clock source is required to drive the 50- Ω BNC input J1. If the clock signal comes from a DSP or microcontroller, resistor R1 should be removed from the circuit. The clock is buffered by inverters (U1) and provides a true (noninverted) output to the TLC5540/TLC5510/TLC5510A and a true equivalent output at pin 22 of the output connector J5. This provides the user a buffered reference clock output for external circuitry.

2.4 Board Schematic

Figure 2–1 shows the EVM board schematic.

Figure 2–1. Board Schematic

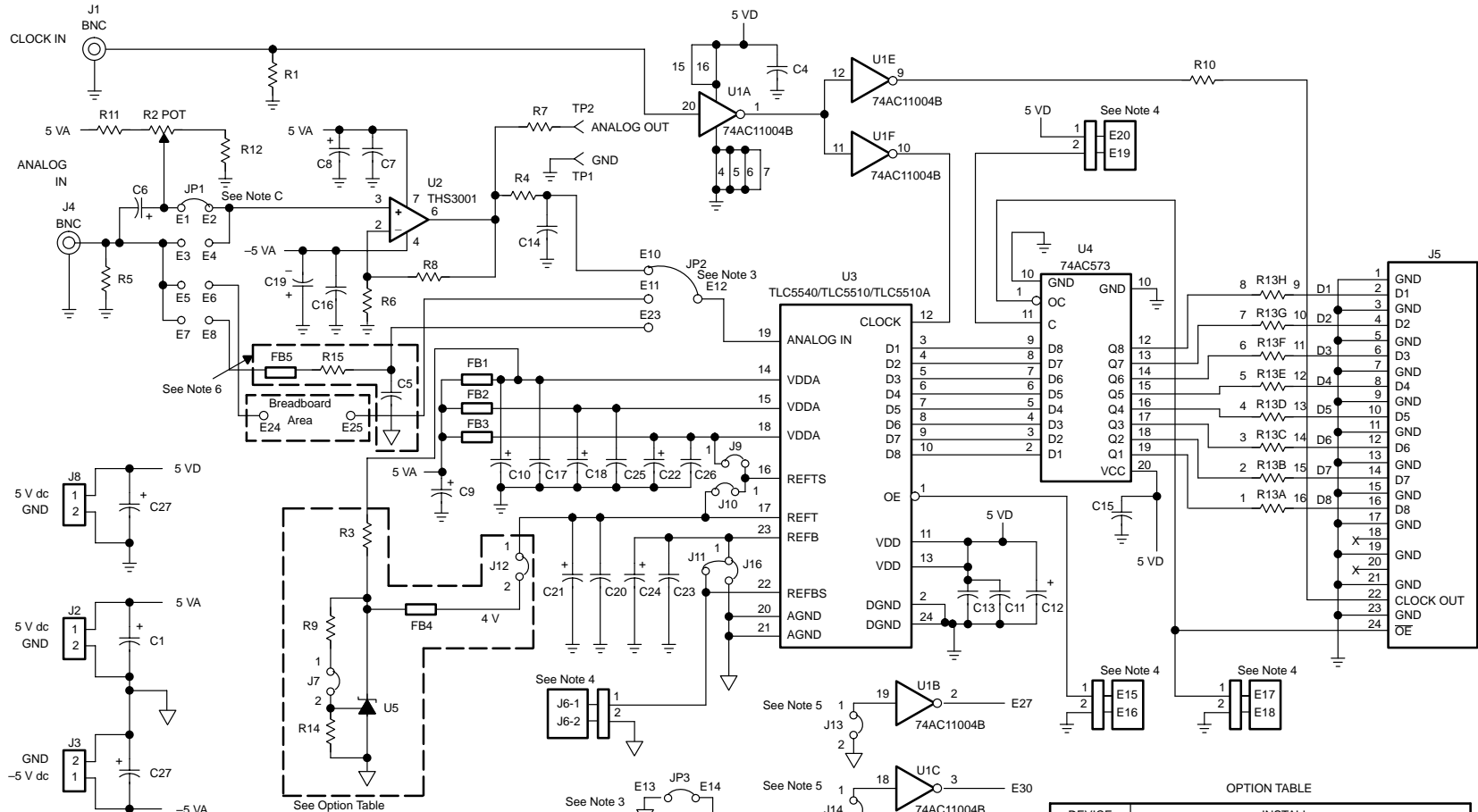

- Notes:**
- 1) Unless otherwise specified capacitors are in μF , $\pm 20\%$, 50 Vdc.
 - 2) Unless otherwise specified resistors are in ohms, $\pm 5\%$.
 - 3) JP1, JP2, JP3, JP4 are jumper wires that are installed at the factory.
 - 4) (J6-1–J6-2), (E15–E16), (E17–E18), and (E19–E20) are 1" center headers with removable jumpers.
 - 5) E-26, E28, and E30 inverter inputs should be tied to J13-2, J14-2, and J15-2, respectively, if not being used.
 - 6) FB5, R15 and C5 are optional LP filter components.

| OPTION TABLE | |
|--------------|---|
| DEVICE | INSTALL |
| TLC5510 | JP1, JP2, JP3, JP4, (J6-1–J6-2), J13, J14, J15, |
| TLC5540 | JP1, JP2, JP3, JP4, (J6-1–J6-2), J13, J14, J15, |
| TLC5510A | JP1, JP2, JP3, JP4, (J6-1–J6-2), J13, J14, J15, (E15–E16), (E17–E18), (E19–E20), J11, J7, J12, R14, R9, R3 U5, J9 AND J16 |

Physical Description

This chapter describes the physical characteristics and PCB layout of the EVM and lists the components used on the module.

| Topic | Page |
|------------------------------------|-------------|
| 3.1 Board Layout | 3-2 |
| 3.2 Board Layers | 3-3 |
| 3.3 Part Descriptions | 3-7 |

3.1 Board Layout

Figure 3-1 shows the EVM board layout.

Figure 3-1. EVM Board Layout

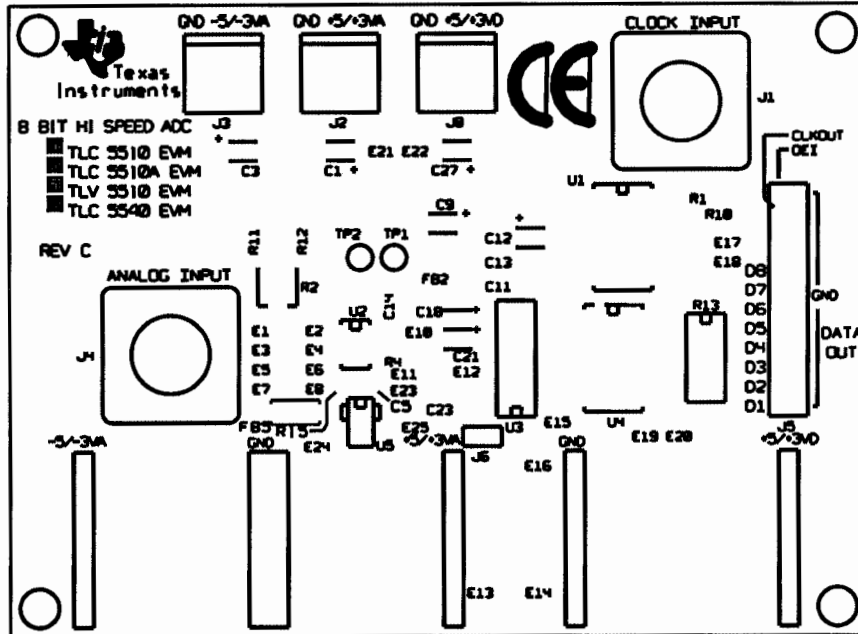

TI TLC 5540 EVM REV. C
SILKSCREEN TOP SIDE

3.2 Board Layers

Figures 3–2 through 3–5 show the EVM board layers.

Figure 3–2. EVM Board Layer 1

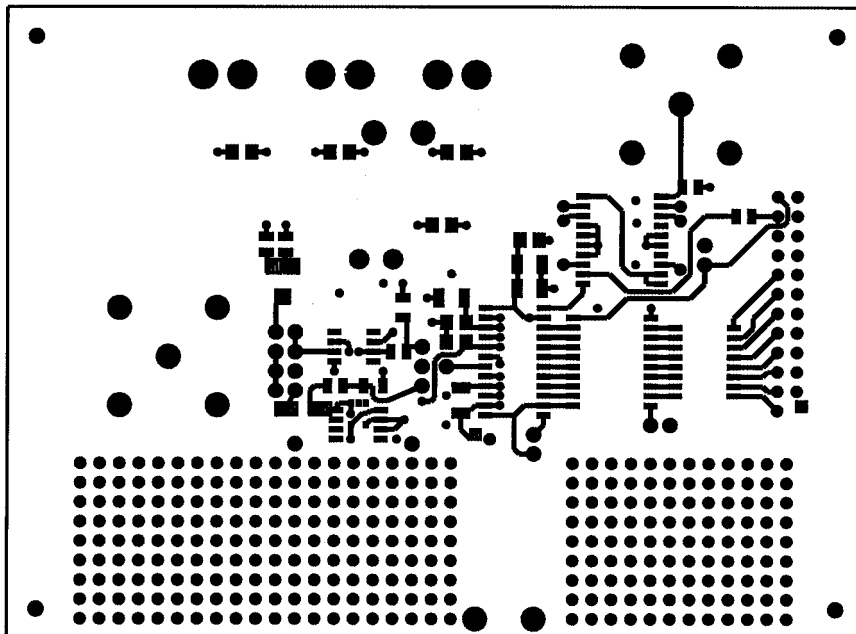

TI TLC 5540 EVM REV. C
LAYER 1 TOP SIDE

Figure 3–3. EVM Board Layer 2

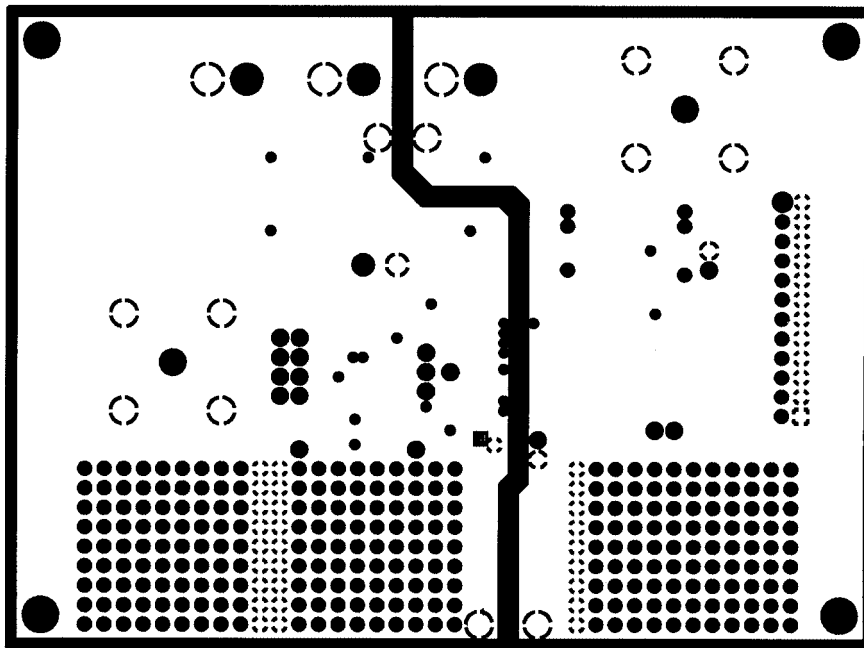

TI TLC 5540 EVM REV. C
LAYER 2 GND PLANE

Figure 3–4. EVM Board Layer 3

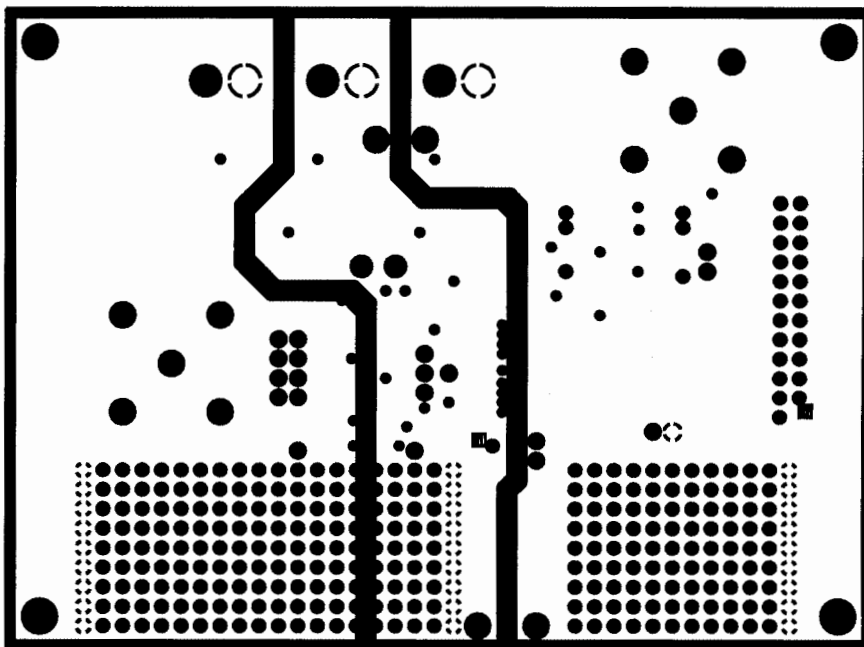

TI TLC 5540 EVM REV. C
LAYER 3 +5V PLANE

Figure 3–5. EVM Board Layer 4

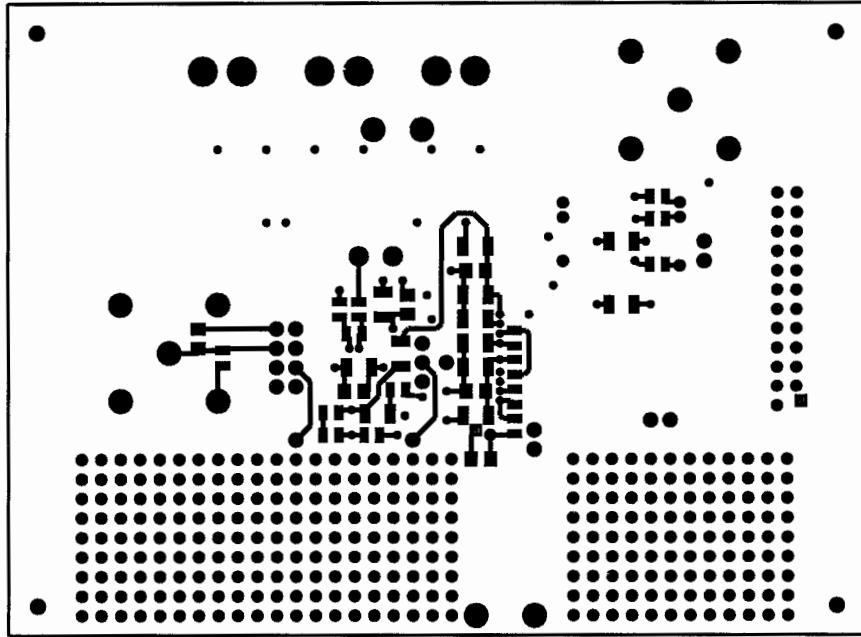

TI TLC 5540 EVM REV. C
LAYER 4 BACK SIDE

3.3 Part Descriptions

Table 3–1 lists and describes the EVM parts. C2 and E9 are not used.

Table 3–1. Part Descriptions

| Quantity | Reference | Description |
|----------|---|--|
| 11 | C4, C7, C11 C13, C15, C16, C17, C20, C23, C25, C26 | 0.1 μ F capacitor, 50 V, 10%, COG, SMD, size 1206 |
| 13 | C1, C3, C6, C8–C10, C12, C18, C19, C21, C22, C24, C27 | 4.7 μ F capacitor, tantalum electrolytic, SMD, size A |
| 1 | C5† | 68 pF capacitor, 50 V, 5%, NPO, SMD, size 1210 |
| 1 | C14 | 100 pF (TLC5540)/150 pF(TLC5510/TLC5510A) capacitor, 50 V, 5%, NPO, SMD, size 0805 |
| 3 | FB1–FB5† | Ferrite bead, SMD, size 1206, Murata BLM31B601SPT |
| 2 | J1, J4 | Connector, BNC, 50 Ω , vertical, PC mount |
| 3 | J2, J3, J8 | Screw terminal, 2 pin, vertical |
| 1 | J5 | Header, 2 \times 12, 0.025 inch square pins, 0.1 inch centers |
| 4 | J6, (E15, E16), (E17, E18), (E19, E20) | Header, 1 \times 2, 0.025 inch square pins, 0.1 inch centers |
| 4 | R1, R4, R5, R7 | Resistor, 49.9 Ω , 1/8 W, 1 %, SMD, size 0805 |
| 1 | R2 | Potentiometer, 10 k Ω , multiturn SMD |
| 1 | R3 | Resistor, 20 Ω , 1/4 W, SMD, size 1210 |
| 2 | R6, R8 | Resistor, 750 Ω , 1/10 W, 1 %, SMD, size 0805 |
| 1 | R9 | Resistor, 15K, 1/10 W, 1%, SMD, size 1210 |
| 1 | R10 | Resistor, 22 Ω , 1/10 W, 5%, SMD, size 0805 |
| 2 | R11, R12 | Resistor, 1 k Ω , 1/10 W, 5 %, SMD, size 0805 |
| 1 | R13 | Resistor pack, 22 Ω \times 8, 1/8 W, 5%, SMD, SOIC-16 |
| 1 | R14 | Resistor, 24.9K, 1/10 W, 1%, SMD, size 1210 |
| 1 | R15† | Resistor, 10 Ω , 1/10 W, 1%, SMD, size 1210 |
| 2 | TP1, TP2 | Test point terminal |
| 4 | P6, (P15, P16), (P17, P18), (P19, P20) | Jumper, for 0.025 inch, square pins, 0.1 inch centers |
| 1 | U1 | IC, (SN)74AC11004DW inverter, SOIC-16 |
| 1 | U2 | IC, THS3001CD operational amplifier, SOIC-8 |
| 1 | U3 | IC, TLC5540INSLE/TLC5510INSLE/TLC5510AINSLE |
| 1 | U4 | IC, SN74AC573DW octal transparent latch, SOIC-20 |
| 1 | U5 | IC, TL431AID or TLV431AIDBV5, SOIC–8, SOT–23 |
| 1 | PCB1 | PCB, TLC5540/TLC5510/TLC5510A |

† C5, FB5 and R15 not on REV C PCB

