

TSC2101EVM

Touch Screen Controller Evaluation Module

User's Guide

IMPORTANT NOTICE

Texas Instruments Incorporated and its subsidiaries (TI) reserve the right to make corrections, modifications, enhancements, improvements, and other changes to its products and services at any time and to discontinue any product or service without notice. Customers should obtain the latest relevant information before placing orders and should verify that such information is current and complete. All products are sold subject to TI's terms and conditions of sale supplied at the time of order acknowledgment.

TI warrants performance of its hardware products to the specifications applicable at the time of sale in accordance with TI's standard warranty. Testing and other quality control techniques are used to the extent TI deems necessary to support this warranty. Except where mandated by government requirements, testing of all parameters of each product is not necessarily performed.

TI assumes no liability for applications assistance or customer product design. Customers are responsible for their products and applications using TI components. To minimize the risks associated with customer products and applications, customers should provide adequate design and operating safeguards.

TI does not warrant or represent that any license, either express or implied, is granted under any TI patent right, copyright, mask work right, or other TI intellectual property right relating to any combination, machine, or process in which TI products or services are used. Information published by TI regarding third-party products or services does not constitute a license from TI to use such products or services or a warranty or endorsement thereof. Use of such information may require a license from a third party under the patents or other intellectual property of the third party, or a license from TI under the patents or other intellectual property of TI.

Reproduction of information in TI data books or data sheets is permissible only if reproduction is without alteration and is accompanied by all associated warranties, conditions, limitations, and notices. Reproduction of this information with alteration is an unfair and deceptive business practice. TI is not responsible or liable for such altered documentation.

Resale of TI products or services with statements different from or beyond the parameters stated by TI for that product or service voids all express and any implied warranties for the associated TI product or service and is an unfair and deceptive business practice. TI is not responsible or liable for any such statements.

Following are URLs where you can obtain information on other Texas Instruments products & application solutions:

Products		Applications	
Amplifiers	amplifier.ti.com	Audio	www.ti.com/audio
Data Converters	dataconverter.ti.com	Automotive	www.ti.com/automotive
DSP	dsp.ti.com	Broadband	www.ti.com/broadband
Interface	interface.ti.com	Digital Control	www.ti.com/digitalcontrol
Logic	logic.ti.com	Military	www.ti.com/military
Power Mgmt	power.ti.com	Optical Networking	www.ti.com/opticalnetwork
Microcontrollers	microcontroller.ti.com	Security	www.ti.com/security
		Telephony	www.ti.com/telephony
		Video & Imaging	www.ti.com/video
		Wireless	www.ti.com/wireless

Mailing Address: Texas Instruments
Post Office Box 655303 Dallas, Texas 75265

EVM IMPORTANT NOTICE

Texas Instruments (TI) provides the enclosed product(s) under the following conditions:

This evaluation kit being sold by TI is intended for use for **ENGINEERING DEVELOPMENT OR EVALUATION PURPOSES ONLY** and is not considered by TI to be fit for commercial use. As such, the goods being provided may not be complete in terms of required design-, marketing-, and/or manufacturing-related protective considerations, including product safety measures typically found in the end product incorporating the goods. As a prototype, this product does not fall within the scope of the European Union directive on electromagnetic compatibility and therefore may not meet the technical requirements of the directive.

Should this evaluation kit not meet the specifications indicated in the EVM User's Guide, the kit may be returned within 30 days from the date of delivery for a full refund. **THE FOREGOING WARRANTY IS THE EXCLUSIVE WARRANTY MADE BY SELLER TO BUYER AND IS IN LIEU OF ALL OTHER WARRANTIES, EXPRESSED, IMPLIED, OR STATUTORY, INCLUDING ANY WARRANTY OF MERCHANTABILITY OR FITNESS FOR ANY PARTICULAR PURPOSE.**

The user assumes all responsibility and liability for proper and safe handling of the goods. Further, the user indemnifies TI from all claims arising from the handling or use of the goods. Please be aware that the products received may not be regulatory compliant or agency certified (FCC, UL, CE, etc.). Due to the open construction of the product, it is the user's responsibility to take any and all appropriate precautions with regard to electrostatic discharge.

EXCEPT TO THE EXTENT OF THE INDEMNITY SET FORTH ABOVE, NEITHER PARTY SHALL BE LIABLE TO THE OTHER FOR ANY INDIRECT, SPECIAL, INCIDENTAL, OR CONSEQUENTIAL DAMAGES.

TI currently deals with a variety of customers for products, and therefore our arrangement with the user **is not exclusive**.

TI assumes **no liability for applications assistance, customer product design, software performance, or infringement of patents or services described herein**.

Please read the EVM User's Guide and, specifically, the EVM Warnings and Restrictions notice in the EVM User's Guide prior to handling the product. This notice contains important safety information about temperatures and voltages. For further safety concerns, please contact the TI application engineer.

Persons handling the product must have electronics training and observe good laboratory practice standards.

No license is granted under any patent right or other intellectual property right of TI covering or relating to any machine, process, or combination in which such TI products or services might be or are used.

Mailing Address:

Texas Instruments
Post Office Box 655303
Dallas, Texas 75265

EVM WARNINGS AND RESTRICTIONS

It is important to operate this EVM within the input voltage range of 0 VDC to 10 VDC and the output voltage range of 3 VDC as described in the EVM User's Guide.

Exceeding the specified input range may cause unexpected operation and/or irreversible damage to the EVM. If there are questions concerning the input range, please contact a TI field representative prior to connecting the input power.

Applying loads outside of the specified output range may result in unintended operation and/or possible permanent damage to the EVM. Please consult the EVM User's Guide prior to connecting any load to the EVM output. If there is uncertainty as to the load specification, please contact a TI field representative.

During normal operation, some circuit components may have case temperatures greater than 40°C. The EVM is designed to operate properly with certain components above 80°C as long as the input and output ranges are maintained. These components include but are not limited to linear regulators, switching transistors, pass transistors, and current sense resistors. These types of devices can be identified using the EVM schematic located in the EVM User's Guide. When placing measurement probes near these devices during operation, please be aware that these devices may be very warm to the touch.

Mailing Address:

Texas Instruments
Post Office Box 655303
Dallas, Texas 75265

Read This First

About This Manual

This user's guide describes the function and operation of the TSC2101 touch screen controller evaluation module. This manual helps the user quickly set up the evaluation board and its accompanying software, to rapidly test and evaluate the TSC2101. A complete circuit description, schematic diagram, and bill of materials are included.

How to Use This Manual

This manual begins with an introductory chapter that describes the EVM and what it can do. If the user is anxious to set up the EVM and start testing, it is recommended that the user reads at least the first two chapters. These two chapters introduce you to the board and how to set it up. Later chapters go into more detail on the board's design and how to access its many features.

Information About Cautions and Warnings

This book may contain cautions and warnings.

This is an example of a caution statement.

A caution statement describes a situation that could potentially damage your software or equipment.

This is an example of a warning statement.

A warning statement describes a situation that could potentially cause harm to you.

The information in a caution or a warning is provided for your protection. Please read each caution and warning carefully.

Related Documentation From Texas Instruments

To obtain a copy of any of the following TI documents, call the Texas Instruments literature response center at (800) 477-8924 or the product information center (PIC) at (972) 644-5580. When ordering, please identify this booklet by its title and literature number. Updated documents can also be obtained through the TI Web Site at www.ti.com.

Data Sheets	Literature Number
TSC2101	SLAS392
TAS1020B	SLES025A
TPS767D301/318	SLVS209D
SN74LVC125A	SCAS290M

FCC Warning

This equipment is intended for use in a laboratory test environment only. It generates, uses, and can radiate radio frequency energy and has not been tested for compliance with the limits of computing devices pursuant to subpart J of part 15 of FCC rules, which are designed to provide reasonable protection against radio frequency interference. Operation of this equipment in other environments may cause interference with radio communications, in which case the user at his own expense will be required to take whatever measures may be required to correct this interference.

Trademarks

3M is a trademark of 3M Company

I²S is a trademark of Philips Corporation

SPI is a trademark of Motorola

Windows is a registered trademark of Microsoft Corporation. (Windows™ 95, Windows™)

Contents

1	Introduction	1-1
1.1	Device Characteristics	1-2
1.2	EVM Block Diagram	1-2
1.3	Analog Inputs/Outputs	1-3
1.4	External Voltage Reference	1-3
1.5	Power Requirements	1-3
1.6	Computer Requirements	1-3
2	Getting Started	2-1
2.1	Unpacking the EVM	2-2
2.2	Default Configuration	2-2
2.3	Quick Start	2-3
3	Operation	3-1
3.1	Switches	3-2
3.1.1	Power Supply Selection	3-2
3.1.2	SPI Selection	3-2
3.1.3	I ² S Selection	3-3
3.1.4	MCLK Selection	3-3
3.1.5	USB Reset	3-3
3.1.6	Cap or Capless Headset Interface	3-3
3.2	Jumpers	3-3
3.2.1	Power Supply Current Measurement	3-4
3.2.2	MIC BIAS Selection	3-4
3.2.3	MIC Input Selection	3-4
3.2.4	EEPROM A1 Select	3-4
3.2.5	Power Supply Selection	3-4
3.2.6	IOVDD Voltage Selection	3-5
3.2.7	AUX Input Selection	3-5
3.3	I/O Connector and Signals	3-5
3.3.1	Audio Connectors	3-5
3.3.2	USB Interface Connector	3-6
3.3.3	External Power Connectors	3-6
3.3.4	Audio Data (I ² S) Connector	3-7
3.3.5	External SPI Connector	3-7
3.3.6	Touch Screen Connectors	3-8
3.3.7	Analog Input Connector	3-8
3.4	Circuit Description	3-8
3.4.1	USB Microprocessor	3-8

3.4.2	Power Supply	3-9
3.4.3	Touch Screen and Analog Inputs	3-10
3.4.4	Audio Interface Circuitry	3-10
3.5	Program Description	3-10
3.5.1	Human Interface Screen	3-10
3.5.2	Data Acquisition Screen	3-12
3.5.3	Configuration Scan	3-16
3.5.4	Audio Screens	3-20
4	Physical Description	4-1
4.1	Bill of Materials	4-2
4.2	EVM Board Silk Screen/Top Layer	4-5
4.3	Schematics	4-6

Figures

1-1	TSC2101 Evaluation Kit Block Diagram	1-2
2-1	Default Software Screen	2-3
3-1	Human Interface Screen (Solid Mode)	3-11
3-2	Human Interface Screen (Dot Mode)	3-12
3-3	Data Acquisition Screen	3-13
3-4	Data Acquisition Screen With Enabled Buffer Function	3-14
3-5	Human Interface Screen With Enabled Buffer Function	3-15
3-6	Reading Content List Screen	3-16
3-7	Configuration Screen	3-17
3-8	Configuration Screen at Median Mode	3-18
3-9	Configuration Screen With External Reference Selection	3-19
3-10	Audio 1 Screen at Default	3-21
3-11	Audio 2 Screen at Default	3-22
3-12	Base Boost Filter Screen at Default	3-23
3-13	Audio 2 Screen With Headset AGC On	3-26
3-14	Audio 2 Screen With Handset AGC On	3-27
3-15	Audio 2 Screen With Cell-Phone AGC On	3-28
3-16	Bass Boost Filter Screen With Different Left/Right Channels	3-30
3-17	Bass Boost Filter Screen With Bad Data	3-31
3-18	Bass Boost Filter Screen With Boost Filter Selection	3-32
4-1	Top Board Layer Silk Screen	4-5

Tables

2-1	Default Configuration Settings	2-2
3-1	Switch Function Reference	3-2
3-2	Jumper Function Reference	3-3
3-3	JUMP4 Settings Reference	3-4
3-4	Audio Connectors	3-5
3-5	Other Audio Inputs	3-6
3-6	USB Interface Connector	3-6
3-7	External Power Connectors	3-6
3-8	Audio Data Connector	3-7
3-9	External SPI Connector	3-7
3-10	Touch Screen Input	3-8
3-10	Analog Input Connector	3-8



Introduction

The TSC2101 is an advanced touch screen controller, which communicates to a host processor through an SPI serial interface. In addition, a mono-input/stereo-output audio codec is included in the TSC2101, and audio data is communicated to the device over an I²S bus. The TSC2101EVM accesses both of these buses through the use of a USB microcontroller, which provides a way to generate data for both buses from a PC running Windows 98SE, 2000, or XP.

Topic	Page
1.1 Device Characteristics	1-2
1.2 EVM Block Diagram	1-2
1.3 Analog Inputs/Outputs	1-3
1.4 External Voltage Reference	1-3
1.5 Power Requirements	1-3
1.6 Computer Requirements	1-3

1.1 Device Characteristics

The TSC2101 is a complete PDA analog interface circuit. It contains a complete 12-bit A/D resistive touch screen converter, including the drivers and the control to measure touch pressure. The TSC2101 interfaces to the host controller through a standard SPI serial interface. The TSC2101 offers two auxiliary analog inputs and one battery voltage measurements. The battery measurement is capable of reading battery voltages up to 6 V, while operating with only a 2.7-V supply. It also has an on-chip temperature sensor capable of reading 1°C resolution.

In addition to these features, the TSC2101 has a high performance audio codec. Access to the audio DAC and ADC sections of the TSC2101 is through an I²S interface. For more detail about TSC2101 device, refer to the TSC2101 data sheet.

1.2 EVM Block Diagram

A block diagram of the TSC2101 evaluation kit is shown in Figure 1–1.

Figure 1–1. TSC2101 Evaluation Kit Block Diagram

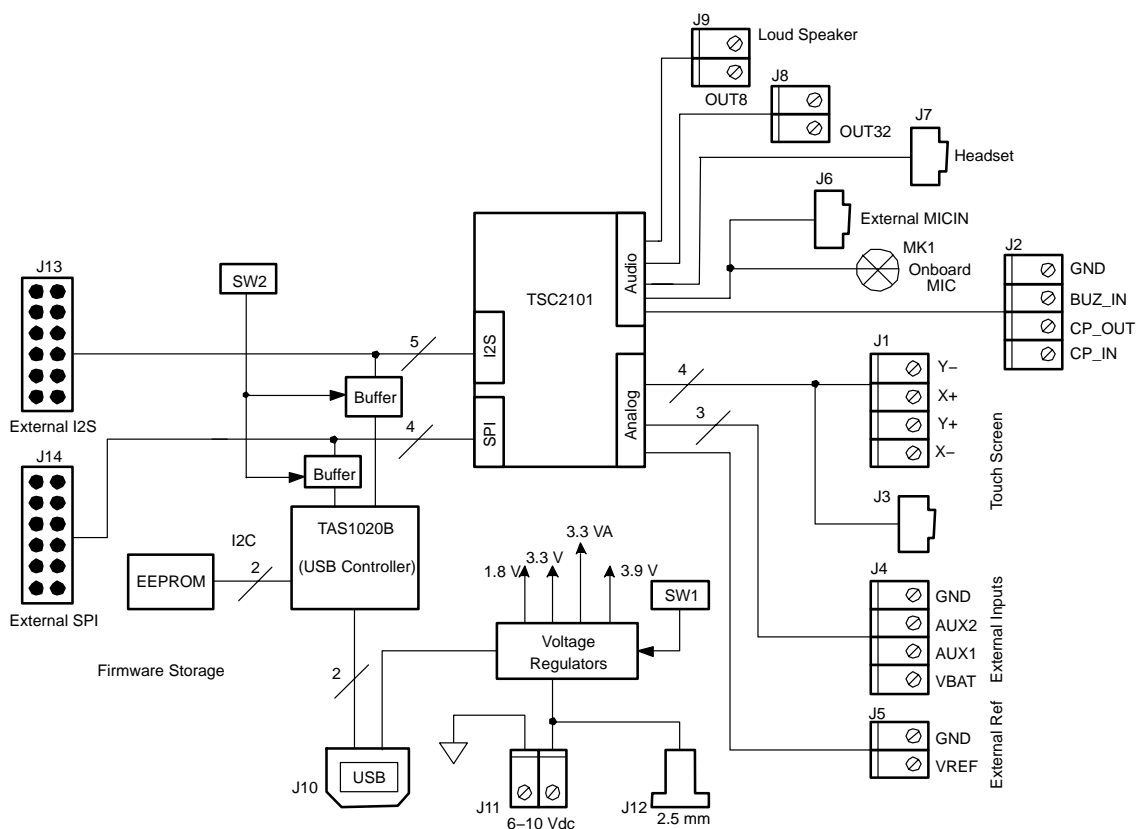

The digital control interface is through either the USB bus or an external SPI bus, selectable through the SW2. While the SW2 is not at the *USB*-controlled position, the onboard SPI bus from the onboard microprocessor is disabled, allowing the external SPI bus to control the TSC2101.

Power supplies are derived from the *USB* bus, or may be provided to the kit through external connectors from an external user-supplied laboratory power supply.

1.3 Analog Inputs/Outputs

Touch screen inputs are provided to the controller through J3. This connector is standard on 3M™ Touch Systems (formerly MicroTouch) TouchTek 4 touch screens. Alternate touch screen input connections are provided on the J1 terminal block. The other analog inputs are brought onto the board through the J4 terminal block. The AUX inputs must be between 0 V and 3.3 V, whereas the battery input VBAT can range from 0 V to 6 V.

On the audio side, there are various audio input/output connectors or plugs that allow the onboard microphone (MK1) or external microphone (J6) signal, and a cell phone input signal or a *BUZZ* input (J2), into the device. The J8 output terminal provides a connector to a 32-Ω speaker; and the J9 output terminal provides a connector to an 8-Ω speaker. Also, a headset can be directly connected into the EVM board through the J7 audio plug.

1.4 External Voltage Reference

If the external voltage reference is used, the reference can be input to the TSC2101 device through the J5 terminal block.

1.5 Power Requirements

The TSC2101EVM can be powered from either the USB port or an external 6-Vdc to 10-Vdc power supply.

1.6 Computer Requirements

The TSC2101EVM software is designed for a Windows based platform PC that supports USB (Windows 98SE, 2000, XP, etc).

Minimum requirements include:

- IBM-compatible Pentium PC or higher
- Windows 98SE/2000/XP
- 64-MByte RAM minimum
- 20-MByte available hard disk space
- CD-ROM drive
- USB port



Getting Started

This chapter guides you through unpacking your EVM and setting it up so you can begin working with it immediately.

Topic	Page
2.1 Unpacking the EVM	2-2
2.2 Default Configuration	2-2
2.3 Quick Start	2-3

2.1 Unpacking the EVM

When unpacking the TSC2101EVM, check the material in the box. The EVM kit includes the following:

- TSC2101EVM board, PWB 6444330
- CD-ROM, 6444333

If any of these components is missing, contact Texas Instruments for a replacement.

2.2 Default Configuration

The TSC2101EVM features a few simple means of configuring its operation. The default settings are shown in Table 2–1. When you unpack your TSC2101EVM, ensure that the board is initially configured as listed in Table 2–1.

Table 2–1. Default Configuration Settings

Board Identifier	Description		Default Setting
SW1	Onboard power supply enables:	1.8 V Enable	SW1_1 ON (Enabled)
		3.9 V Enable	SW1_2 ON (Enabled)
		3.3 V Enable	SW1_3 ON (Enabled)
		Spare	SW1_4 OFF
SW2	On/OFF board control selection:	Onboard I2S	SW1_1 ON (Onboard)
		Onboard MCLK	SW1_2 ON (Onboard)
		Onboard SPI	SW1_3 ON (Onboard)
		USB Reset	SW1_4 ON (Enabled)
SW3	Headset cap/cap-less selection:		Cap-Less Output
JMP3	MIC BIAS source from (3.3 V or TSC2101)		2 to 3 (TSC2101)
JMP4	Differential MIC input selection		Removed (Single-ended)
JMP5	FW Boot source selection		Installed (EEPROM)
JMP6	Power Supply (USB or external) selection		1 to 2 (USB)
JMP7	TSC2101 IOVDD (3.3 V or 1.8 V) power selection		1 to 2 (3.3 V)
JMP8	AUX2 resistance measurement		Removed
JMP9	AUX1 resistance measurement		Removed

Notes: 1) For more detail about the onboard configurations, refer to the next chapter.

Notes: 2) JMP1, JMP2, and JMP10 through JMP13 are installed by default. These jumpers can be replaced by current meters for evaluating or testing the corresponding power consumption.

2.3 Quick Start

Once the TSC2101EVM has been unpacked and you have verified that the board is configured as shown in Table 2–1, install the software.

Place the CD-ROM into the CD-ROM drive of the PC. Locate and run the Setup program on the disk. The Setup program installs the TSC2101EVM software on your PC. Note that if you are running Windows 2000 or XP, you need administrator privileges to install the software. Follow the instructions provided by the installer.

When the installation is complete, connect a USB cable from the PC to the TSC2101EVM. When the TSC2101EVM is connected to the PC the first time, the user may see a message that a Human Interface / Audio Device has been connected. Once this connection has been made, launch the TSC2101EVM software on the PC.

The software should automatically find the TSC2101EVM. If the board is found, the screen shown in Figure 2–1 appears.

Figure 2–1. Default Software Screen

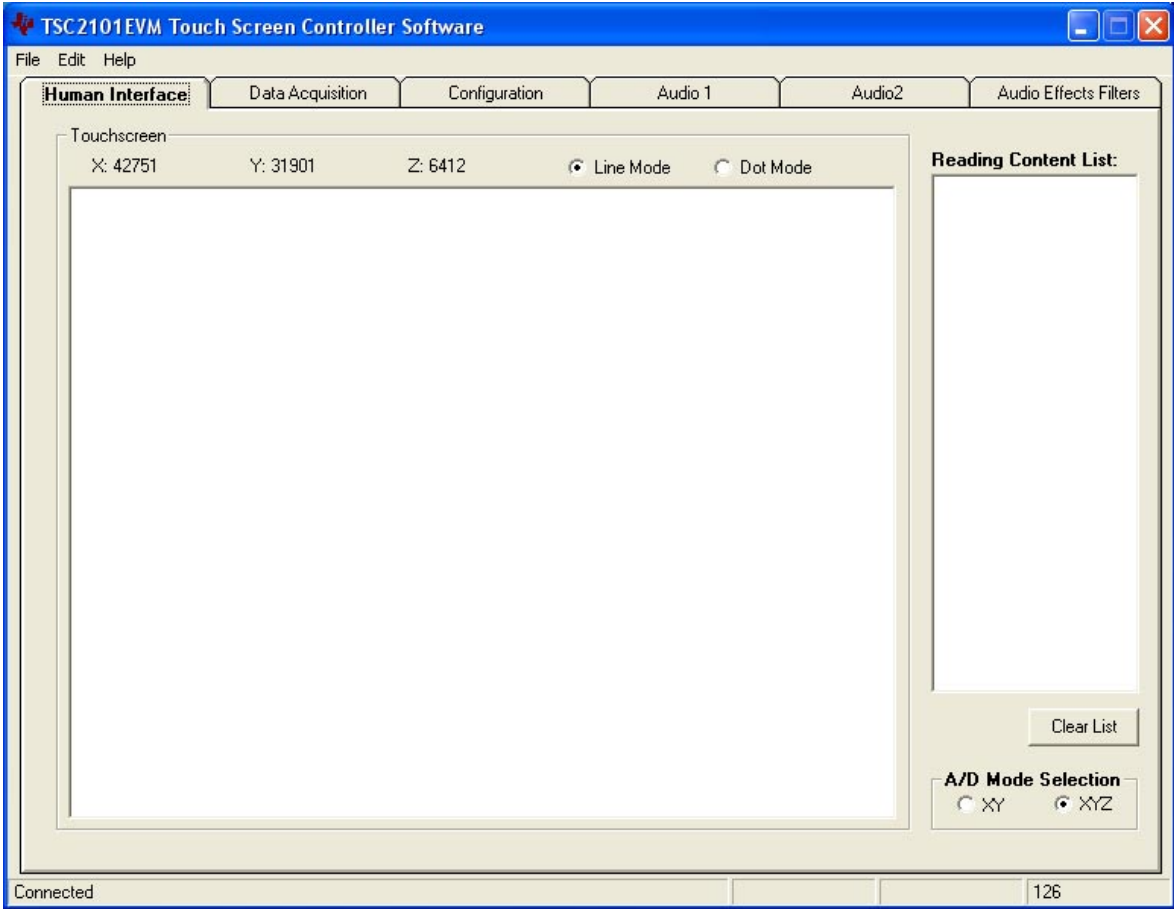

In order to use the touch screen features, a 4-wire resistive touch screen must be connected to J3 or J1 of the TSC2101EVM.

If a speaker is connected to J9 (the loud speaker connection terminal), a *ding* sound is heard when the USB cable from the PC is plugged into J10 of the EVM. Additional *dings* are heard when launching the software.

The EVM is set to default with the side-tone function enabled. Therefore, when powered up, signals to the onboard, mini-microphone (MX1) are heard through the speaker connected to J9.

Operation

This chapter describes each function of the TSC2101 evaluation kit and how to use the accompanying software to control and use the TSC2101.

Topic	Page
3.1 Switches	3-2
3.2 Jumpers	3-3
3.3 I/O Connector and Signals	3-5
3.4 Circuit Description	3-8
3.5 Program Description	3-10

3.1 Switches

Table 3–1 shows the function of each switch on the EVM.

Table 3–1. Switch Function Reference

Reference Designator		Setting	Function	Factory Default	Subsection
SW1	SW1–1	ON	1.8-V power supply enabled	ON	3.1.1
		OFF	1.8-V power supply disabled		
	SW1–2	ON	3.9-V power supply enabled		
		OFF	3.9-V power supply disabled		
	SW1–3	ON	3.3-V power supply enabled		
		OFF	3.3-V power supply disabled		
SW2	SW2–1	ON	Onboard I2S selected	ON	3.1.3
		OFF	External I2S selected		
	SW2–2	ON	Onboard MCLK selected	ON	3.1.4
		OFF	External MCLK selected		
	SW2–3	ON	Onboard SPI selected	ON	3.1.2
		OFF	External SPI selected		
	SW2–4	ON	USB reset connected to the TSC2101	ON	3.1.5
		OFF	USB reset is not connected to the TSC2101		
SW3		CAP	Output to headset jack with CAPs	CAPLESS	3.1.6
		CAPLESS	Output to headset jack without CAPs		

3.1.1 Power Supply Selection

SW1 enables or disables the onboard power supplies, including the 1.8 V, the 3.3 VA, and the 3.9 V, so that the power up/down performance of the TSC2101 can be evaluated. The 1.8 V provides the 1.8-V digital core power for the TSC2101; the 3.3 VA provides the analog power supply for the TSC2101; and the 3.9 V gives the analog driver power for the TSC2101.

Note that the EVM board has four regulated power supplies. In addition to the 1.8 V, 3.3 VA and 3.9 V supplies, the fourth power supply 3.3 V cannot be disabled. This power supply provides the power for the TSC2101's digital I/Os, when selected, and the power for the USB control device TAS1020B.

3.1.2 SPI Selection

The SPI bus on the TSC2101 provides the main interface between a host processor and the TSC2101 device. The onboard TAS1020B plays the role of the host processor, if the SW2–3 is set ON. If an external processor or SPI device is used, set the SW2–3 to the OFF position so as to disable the onboard SPI interface and open the TSC2101 SPI port to the external SPI bus.

3.1.3 I²S Selection

The I²S bus on the TSC2101 can interface with the onboard host processor, the TAS1020B USB controller, or with other offboard external I²S processor or devices. When the SW2-1 is set to *ON*, the manufacture default, the TSC2101 I²S is connected to the TAS1020B's I²S. Otherwise, if the SW2-1 is shifted to *OFF*, the buffer between the onboard I²S ports is disabled so that an external I²S can communicate with the TSC2101 I²S port.

3.1.4 MCLK Selection

The TSC2101 needs a proper MCLK for the basic audio ADC/DAC functions. The onboard processor, TAS1020B, generates an 11.2896-MHz frequency to provide the MCLK. If an external MCLK is preferred, turn off the SW2-2.

3.1.5 USB Reset

A reset signal output from the onboard TAS1020B processor can be used to reset the TSC2101 whenever the TAS1020B is resetting. SW2-4 enables/disables the connection. By default, the connection is enabled. If the processor is not active, the connection to TSC2101 should be disabled by turning off the SW2-4.

3.1.6 Cap or Capless Headset Interface

Corresponding to the onchip cap or capless headset interface selection, the EVM has the SW3 built in for use with the different headset interface configurations. For more details, refer to the TSC2101 data sheet.

3.2 Jumpers

Table 3-2 shows the function of each jumper on the EVM.

Table 3-2. Jumper Function Reference

Reference Designator	Setting	Function	Factory Default	Subsection
JMP1, JMP2, JMP10, JMP11, JMP12, JMP13	Removed	Power is not provided to the TSC2101	Installed	3.2.1
	Installed	Power is provided to the TSC2101		
JMP3	1 to 2	MIC BIAS from fixed resistor	2 to 3	3.2.2
	2 to 3	MIC BIAS from TSC2101		
JMP4		Differential MIC input selection	Removed	3.2.3
JMP5	Removed	FW boot from external resources	Installed	3.2.4
	Installed	FW boot from EEPROM		
JMP6	1 to 2	EVM board power supply by USB	1 to 2	3.2.5
	2 to 3	EVM board power supply externally		
JMP7	1 to 2	TSC2101 uses 3.3 V IOVDD	1 to 2	3.2.6
	2 to 3	TSC2101 uses 1.8 V IOVDD		
JMP8	Removed	AUX2 as voltage measurement	Removed	3.2.7
	Installed	AUX2 as resistance measurement		
JMP9	Removed	AUX1 as voltage measurement	Removed	
	Installed	AUX1 as resistance measurement		

3.2.1 Power Supply Current Measurement

Six jumpers are on the front of the six power supply pins of the TSC2101. The jumpers can be replaced by current meters that measure and monitor the currents to the corresponding power supply pins. Refer to Table 2–1, Note 2.

3.2.2 MIC BIAS Selection

JMP3 selects the handset microphone bias to come from the TSC2101 (MICBIAS_HND pin) or from an external resistor, R14, which is not installed on the TSC2101EVM board. If an external bias is needed, the appropriate size resistor can be soldered into the R14 location on the board, and JMP3 is set to connect between positions 1 and 2. If the microphone bias is not required, do not install the jumper top for JMP3 in any position.

3.2.3 MIC Input Selection

The headset microphone input MICIN_HED and the handset microphone input MICIN_HND can be connected to the TSC2101 device in single-ended mode.

Differential microphone input is selected using pins MICIN_HED and AUX1/AUX2 as a differential input pair; and/or by using the pins MICIN_HND and AUX1/AUX2 as differential input pair, selected through bits 5 to 7 (D5, D6, D7) in the TSC2101 control register page 02 and address 0x03. If a differential microphone input is selected, the JMP4 must be set to provide the AUX1/AUX2 with microphone bias. Table 3–3 gives the JMP4 settings corresponding to the selected differential inputs.

Table 3–3. JUMP4 Settings Reference

Reference Designator	Setting	MICIN Selection
JMP4	All removed	Single-Ended MICINs
	4 to 6	MICIN_HED and AUX1 differential pair
	4 to 2	MICIN_HED and AUX2 differential pair
	3 to 5	MICIN_HND and AUX1 differential pair
	3 to 1	MICIN_HND and AUX2 differential pair

3.2.4 EEPROM A1 Select

The TSC2101EVM loads its firmware from an onboard EEPROM. In order to use the firmware in this EEPROM, its A1 address line must be pulled low; therefore, JMP5 should stay installed for normal use.

This jumper can be removed when firmware updates are to be made.

3.2.5 Power Supply Selection

The TSC2101EVM can be powered from the USB port directly, or an external power supply can be provided through J11 or J12. JMP6 allows the user to select either the USB or external power sources.

3.2.6 IOVDD Voltage Selection

One of the features of the TSC2101 device is that the digital IO power supply for the TSC2101 device is flexible, ranging from 1.1 V to 3.6 V. To evaluate the feature, the EVM has the JMP7 for the selection of the IOVDD, either 3.3 V (JMP7 to 1 and 2 position), or 1.8 V (JMP7 to 2 and 3 position).

3.2.7 AUX Input Selection

The auxiliary analog input pins, AUX1 and AUX2, can be used to measure the voltages applied on the pins or the resistance on the pins, selectable in the TSC2101 control register page 1 and address 0x0C. Also, under the resistance measurement mode, there are two operation modes, either internal bias or external bias resistance measurement. When AUX1 is used for the external bias resistance measurement, install the JMP9; when AUX2 is used for the external resistance measurement, install the JMP8. Otherwise, leave the jumper(s) uninstalled. Refer to the TSC2101 data sheet for more details.

Additionally, the AUX1 or AUX2 can be paired with the MICIN-HED or MICIN-HND to be used as the TSC2101 audio codec's differential microphone input port. Refer to section 3.2.3 and the TSC2101 data sheet for more details.

3.3 I/O Connector and Signals

The various connectors on the TSC2101EVM are described in this section.

3.3.1 Audio Connectors

The TSC2101 audio inputs and outputs are routed through the 3,5-mm jacks or terminal blocks. Note the polarity of channel assignments for these connectors.

Table 3–4. Audio Connectors

Reference Designator	Name	Description	
J6	Mic In	Microphone input to handset microphone in (MICIN_HND)	Tip = mic input
			ring = mic bias voltage (or MICIN if differential)
			sleeve = ground
J7	HEADSET	Headset input/output connection	tip1 = headset microphone input
			tip2= headset right output channel
			ring = headset left output channel
			sleeve = audio common ground
J8	OUT32	Receiver driver (32-Ω output) connection	J8+ = OUT32P(SPK1)
			J8- = OUT32M
J9	OUT8	Loud speaker (8-Ω output) connection	J9+ = OUT8P
			J9- = OUT8M

Additionally, the cell-phone input and output signals can be brought to the EVM board through the terminal block J2. The buzz input is also routed to J2.

Table 3–5. Other Audio Inputs

Reference Designator	Description	Pin Number	Signal Name	Function
J2	Other audio inputs	1	CP IN	Cell-phone input
		2	CP OUT	Cell-phone output
		3	BUZZ IN	Buzz signal input
		4	GND	Ground

3.3.2 USB Interface Connector

Connection to a USB cable from a PC is made through J10, a standard USB type-B receptacle.

Table 3–6. USB Interface Connector

Reference Designator	Description	Pin Number	Signal Name	Function
J10	USB slave connection to PC	1	VCC	+5-V supply from USB
		2	D–	–Differential USB signal
		3	D+	+Differential USB signal
		4	GND	Ground

3.3.3 External Power Connectors

Whereas it is most convenient to power the TSC2101EVM from the USB bus, external power supplies can be used. The two connectors detailed in Table 3–7 are provided for the external power.

Table 3–7. External Power Connectors

Reference Designator	Description	Pin Number	Signal Name
J11	External power	1	6-Vdc to 10-Vdc input
	Terminal block	2	Ground
J12	External power jack	—	6-Vdc to 10-Vdc input, positive center terminal

3.3.4 Audio Data (I²S) Connector

The I²S bus, which carries audio data to and from the TSC2101, is connected to header J13. The I²S signals from the on-board host processor (TAS1020B) can be disabled by turning off the SW2-1. Also refer to the previous section on switch settings.

Table 3–8. Audio Data Connector

Reference Designator	Description	Pin Number	Signal Name
J13	Audio data (I ² S) connector	1	MCLK
		3	BCLK
		5	LRCLK
		7	I2SDIN
		9	I2SDOUT
		11	Power down
		2, 4, 6, 8, 10, 12	Ground

3.3.5 External SPI Connector

The TSC2101 SPI port is connected to header J14. It can be driven by an external source if the onboard microprocessor is disabled by turning off the SW2-3 and removing the A1 select jumper (JMP5). Also refer to the previous sections on switch and jumper settings.

Table 3–9. External SPI Connector

Reference Designator	Description	Pin Number	Signal Name	Function
J14	External SPI bus	1	RESET	Reset line
		3	SS	Slave select for SPI bus
		5	SCLK	Serial clock for SPI bus
		7	MOSI	Master out, slave in data line
		9	MISO	Master in, slave out data line
		11	PENIRQ	Pen down or \overline{DAV} interrupt line
		2, 4, 6, 8, 10, 12	GND	Ground

3.3.6 Touch Screen Connectors

A 4-wire touch screen connects to the EVM board through connector J3. This connector is standard on 3M Touch Systems (formerly MicroTouch) TouchTek 4 touch screens. A standard terminal block connection is available on J1 for those users who have touch screen connectors that do not match the J3 configuration.

Table 3–10. Touch Screen Input

Reference Designator	Description	Pin Number	Signal Name	Function
J3, J1	Touch screen input	1	X–	Touch screen X– electrode
		2	Y+	Touch screen Y+ electrode
		3	X+	Touch screen X+ electrode
		4	Y–	Touch screen Y– electrode

3.3.7 Analog Input Connector

The auxiliary and battery inputs to the touch screen controller are brought onto the EVM board through terminal block J4. The pinout is shown in Table 3– 11.

Table 3–11. Analog Input Connector

Reference Designator	Description	Pin Number	Signal Name	Function
J4	Battery and auxiliary inputs to the touch screen control	1	VBAT	Battery input, 0 V to 6 V
		2	AUX1	Auxiliary input 1, 0 V to VREF
		3	AUX2	Auxiliary input 2, 0 V to VREF
		4	GND	Ground

3.4 Circuit Description

The TSC2101 evaluation kit circuitry consists of a USB microprocessor, power supply circuitry, touch screen and analog input interfaces, and audio interface circuitry (both analog and digital). These circuits are described in the following sections.

3.4.1 USB Microprocessor

The TSC2101EVM has a USB interface for connecting to a PC. This connection is made through a TAS1020B streaming audio processor, U10. The SPI interface to the TSC2101 can be controlled from two sources: the external SPI header, J14, or through the onboard microprocessor (U10) via USB. The U10 outputs are enabled only when the supplied firmware is loaded, and the corresponding bus(es) is enabled, refer to switch description for SW2 in section 3.1.

The firmware resides in the serial EEPROM chip, U2. U10 only loads firmware from U2 when the U2 A1 address line is pulled low. To disable firmware loading, A1 must be high, by having JM5 removed. Refer to section 3.2.4.

When the firmware is loaded and active, D2 (a yellow LED) is lit. If no firmware is loaded, the U10 output should be in 3-state. In order to ensure that the onboard host processor does NOT effect the interface between the external SPI bus to drive the TSC2101, turn OFF the SW2-3.

When the SW2-3 is ON and the firmware is loaded, the PC software enables the onboard microprocessor to control the SPI bus.

Caution

Do not drive the external SPI bus when the firmware is loaded and the onboard microprocessor is active. If you want to use the external SPI bus, disable the microprocessor by removing JMP5, turning OFF the SW2-3 to isolate the microprocessor SPI bus, and cycling power to the TSC2101EVM.

Likewise, the I²S signals for the digital audio can be driven either externally by J13 or by the USB audio controller.

Caution

Do not drive the external I²S bus when the firmware is loaded and the onboard microprocessor is active. If you want to use the external I²S bus, disable the microprocessor by removing JMP5, turning OFF the SW2-1 to isolate the microprocessor I²S bus, and cycling power to the TSC2101EVM.

3.4.2 Power Supply

Power to the TSC2101EVM can be derived directly from the USB interface or externally supplied through the J11 terminal block or the J12 barrel jack connector. Supply voltages of 6 Vdc to 10 Vdc must be supplied from an external supply. Because it is regulated on the TSC2101EVM, this input voltage does not need to be regulated as long as it falls within this range. D1 prevents damage to the board in the event a power supply is connected in reverse polarity.

Two linear regulators are on the board. U3 regulates the digital power-supply voltage to provide 1.8 V for the TSC2101 digital core, or the digital IO power supply if the IOVDD is selected as 1.8 V by JMP7. Also, U3 provides the 3.3-V digital power for all of other digital circuits. U4 regulates the analog power supplies. Its 3.9-V power supply is used for the TSC2101 analog driver power DRVDD2; its 3.3 VA powers the rest of the analog circuits on the board.

The regulated supply voltages have LEDs attached that alert the user that the supply is working. D2 (red) is the indicator for the 1.8-V power supply; D4 (green) is the indicator for the 3.3-V power supply; D5 (green) is the indicator for the 3.9-V driver power; and D6 (green) is the indicator for the 3.3-VA analog power supply.

3.4.3 Touch Screen and Analog Inputs

Terminal block J4 provides input connection points for the battery and auxiliary inputs. Battery input can range from 0 V to 6 V, and the auxiliary inputs can range from 0 V to VREF. The touch screen can be connected to J3 or to the J1 terminal block.

Each of these seven inputs has a provision for an RC filter to be placed in line with the signal. As shipped, all resistors are 0 Ω , and the capacitors are not installed. If noisy conditions prevent obtaining good readings from the TSC2101, 0.1- μ F capacitors can be installed in positions C1 through C7. If more filtering is required, the 0- Ω resistors should be unsoldered from the board and replaced with small resistors. Note that increasing the capacitance on the touch screen inputs requires increased panel voltage stabilization time and increased precharge and sense times, thus lowering the available number of readings per second.

3.4.4 Audio Interface Circuitry

A mono Electret microphone can be connected to J6. This jack provides both audio and bias connections. Bias for the microphone can be supplied either from the TSC2101 mic bias circuitry or from an external resistor, R14. R14 is not installed on the TSC2101EVM, but can be installed by the user. Internal or external bias is selected by JMP3.

A small onboard microphone is also on the EVM, parallel to the J6. Without an external electrical microphone, voice can be input to the TSC2101 through this microphone.

The TSC2101 has a built-in headset interface. J7 is the jack for connection to the headset where the microphone input is mono and the audio output can be stereo. The signal to the headset can be dc-decoupled through the capacitors (C21 and C22) or *capless*. Note that the switch SW3 must be used according to the software settings to work either at the *CAP* mode or the *CAPLESS* mode. Refer to the related description in the data sheet.

The audio output can also be connected to a 32- Ω speaker through J8, and the 8- Ω loud speaker through J9.

Additionally, the cell-phone input/output, and the buzz input, can be connected to the TSC2101 device through the onboard terminal block J2.

3.5 Program Description

After installing the software for the TSC2101EVM as described in section 2.3, the user can begin to evaluate and develop with the TSC2101.

3.5.1 Human Interface Screen

The program's interface is a simple, six-tab interface. Clicking on a tab takes you to the functions associated with that tab. The program begins on the Human Interface screen (the default) as shown in Figure 3–1.

Figure 3–1. Human Interface Screen (Solid Mode)

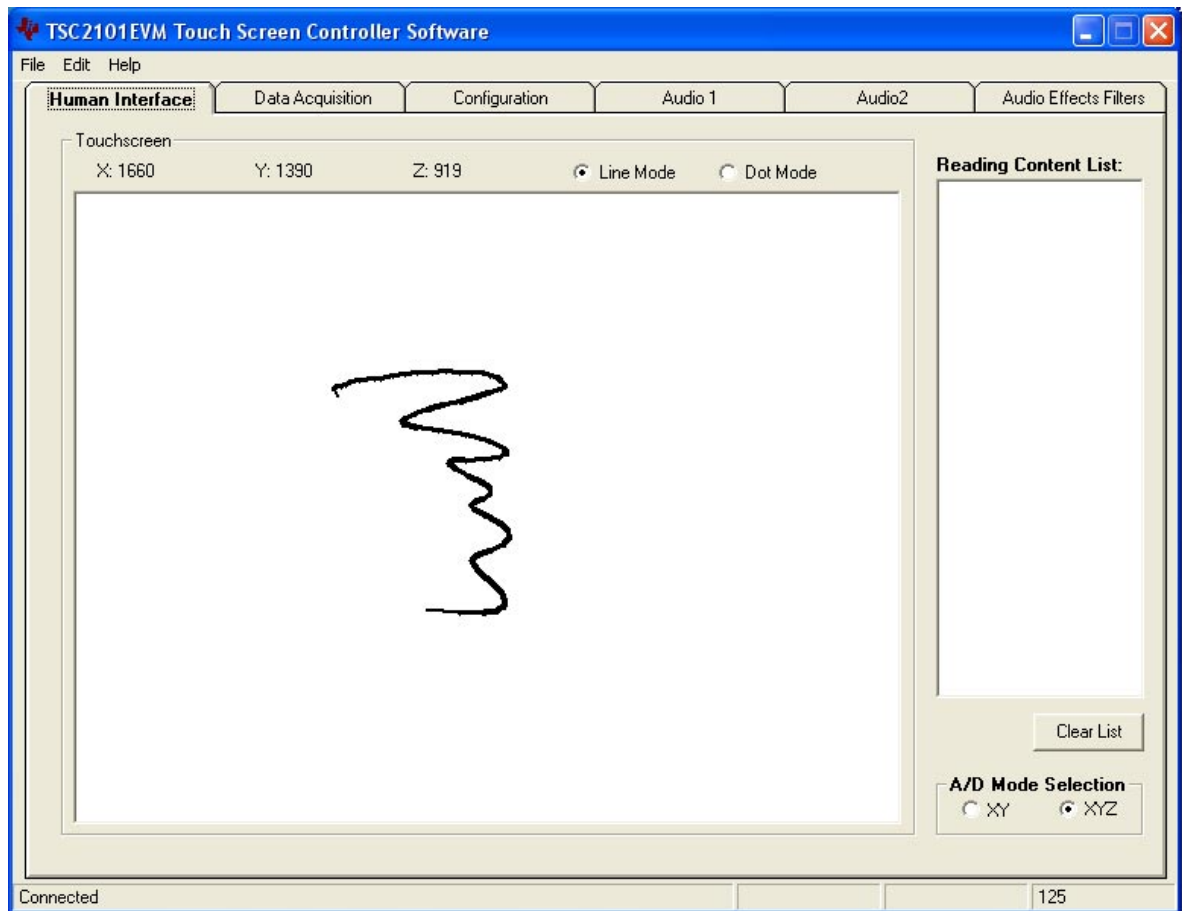

This screen reflects the touch screen from the TSC2101EVM. The status bar at the bottom of the screen is divided into four sections and shows the status of communication between the PC and the EVM. Starting from the left, the first section shows the status of the connection. If an error in communication occurs, an error message appears here; otherwise, it looks as shown in Figure 3–1. The final section, on the right side of the status bar, shows the number of readings per second being taken from the touch screen.

The touch screen box on this screen is updated when a touch is detected on the touch screen. As the touch screen is drawn on, the motion on the touch screen is translated into pixels on the screen. The software takes X and Y, or X, Y, and Z readings, which are shown at the top of this box. Even though TSC2101 has five different touch screen scan modes, this EVM allows only two selections at this tab, either X and Y, or X, Y, and Z. Default is the X, Y, and Z mode. In X and Y mode, the pixel size is fixed. In the X, Y, and Z mode, as the touch pressure is increased, the pixel size increases. A lighter touch results in smaller pixel sizes. Refer to Figure 3–1.

The X and Y, or X, Y, and Z mode is selected by clicking on the option at the *A/D Mode Selection Box*. The touch is shown on the screen in solid mode, as shown in Figure 3–1, or dot mode as shown in Figure 3–2. The line or dot mode is selected by the corresponding option on the top of the drawing screen.

The display can be cleared by pressing the Enter or Backspace key on the PC keyboard.

Figure 3–2. Human Interface Screen (Dot Mode)

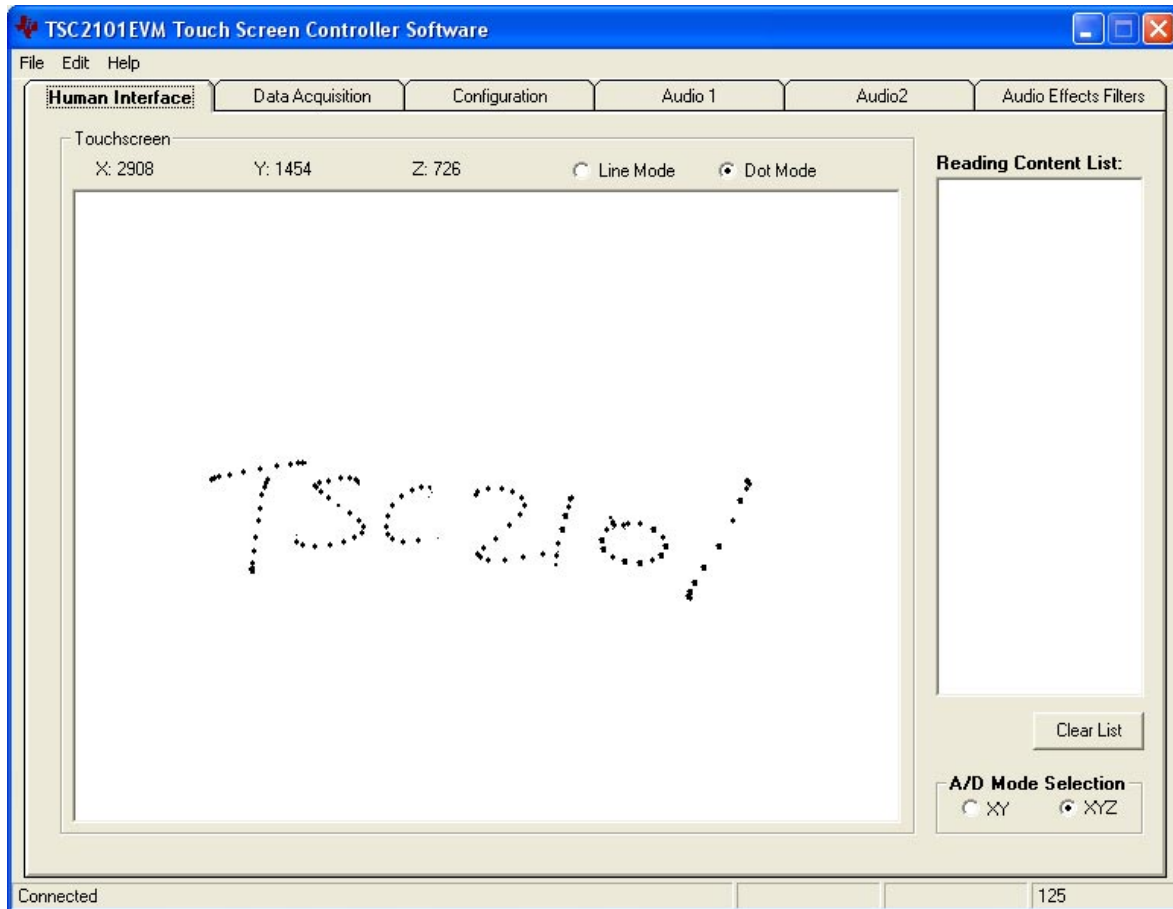

By the right side of the screen, another window is used to show the touch screen data when the TSC2101 is under the *buffer* mode, which is explained in the next section: Data Acquisition Screen.

3.5.2 Data Acquisition Screen

The data acquisition functions of the TSC2101 can be accessed on this screen as shown on the left side of the Figure 3–3.

Figure 3–3. Data Acquisition Screen

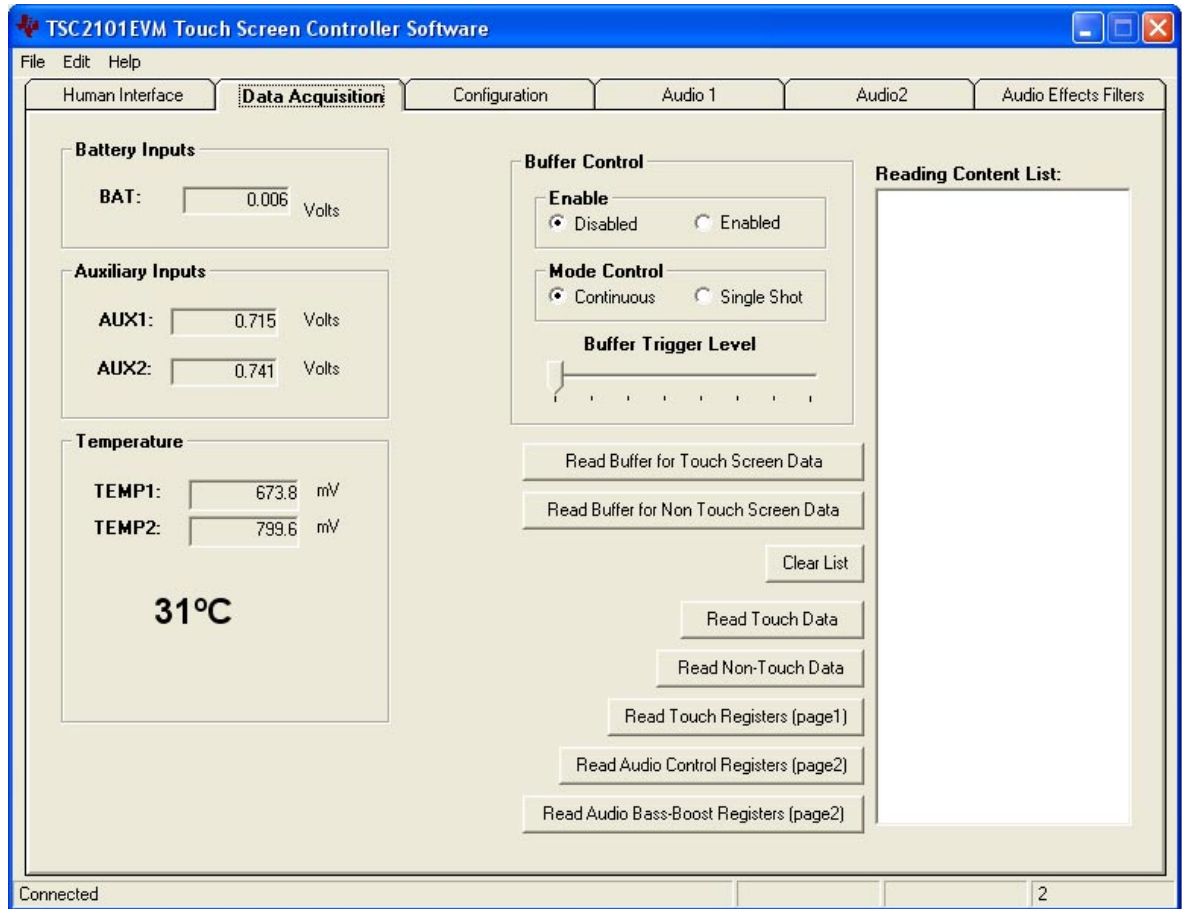

3.5.2.1 Nontouch Data Acquisition

At this screen with the buffer mode *NOT* enabled, the TSC2101 is commanded to perform the battery and auxiliary input voltage readings, and then a TEMP1 and TEMP2 measurement. These measurements are all repeated twice every second, and the results are displayed on the three boxes at the left side of this screen.

3.5.2.2 Buffer Function

In the middle of the screen, the buffer mode settings can be accessed. By default, the buffer function is disabled and all touch or nontouch data are converted and stored to the corresponding registers. When the *buffer* function is enabled, by checking the *Enable* option, as shown at Figure 3–4, the data is converted and saved to the *buffer* registers in page 3 of the TSC2101 memory space. Refer to the data sheet for the details of the *buffer function*.

Figure 3–4. Data Acquisition Screen With Enabled Buffer Function

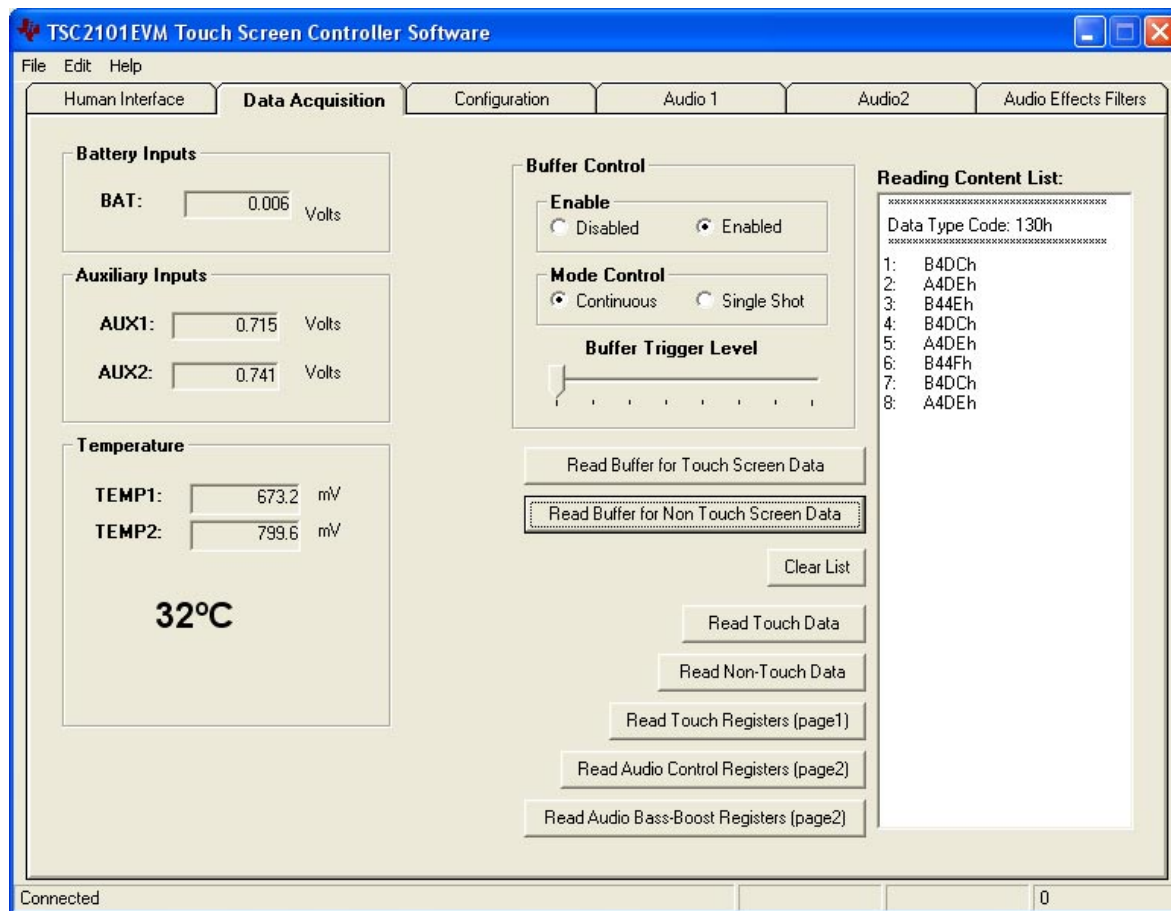

When the buffer function is enabled, the two data-reading buttons place the TSC2101 into either self-controlled mode, by clicking on the button *Read Buffer for Touch Screen Data*, or host-controlled mode, by clicking on the button *Read Buffer for Non Touch Screen Data*.

When clicking on *Read Buffer for Touch Screen Data*, the SW shifts from this screen to the Human Interface screen. The touch screen data in the TSC2101 page 3 registers shows up on the right side list box when the screen is touched, as Figure 3–5 illustrates. Note that under the buffer mode, the touch screen data does not show up on the touch screen drawing box.

Figure 3–5. Human Interface Screen With Enabled Buffer Function

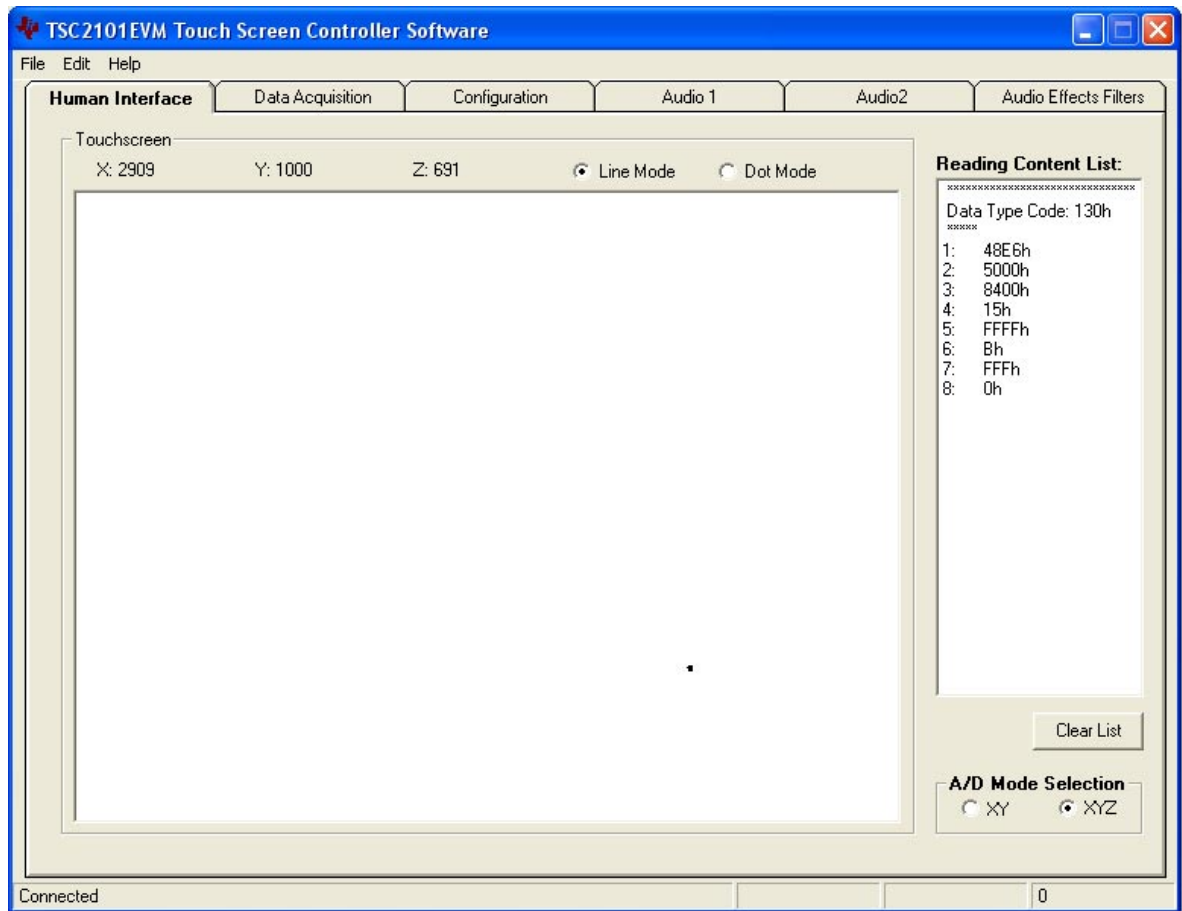

When clicking on *Read Buffer for Non Touch Screen Data*, the TSC2101 enters *auto-scan* mode to perform the auto scan on AUX1, AUX2, and TEMP1. These nontouch screen raw data are moved into the *Reading Content List* on the right side of the Data Acquisition tab, as shown in Figure 3–6. The data in Figure 3–6 is listed in this order: AUX1, AUX2, TEMP1, AUX1, AUX2, etc.

Figure 3–6. Reading Content List Screen

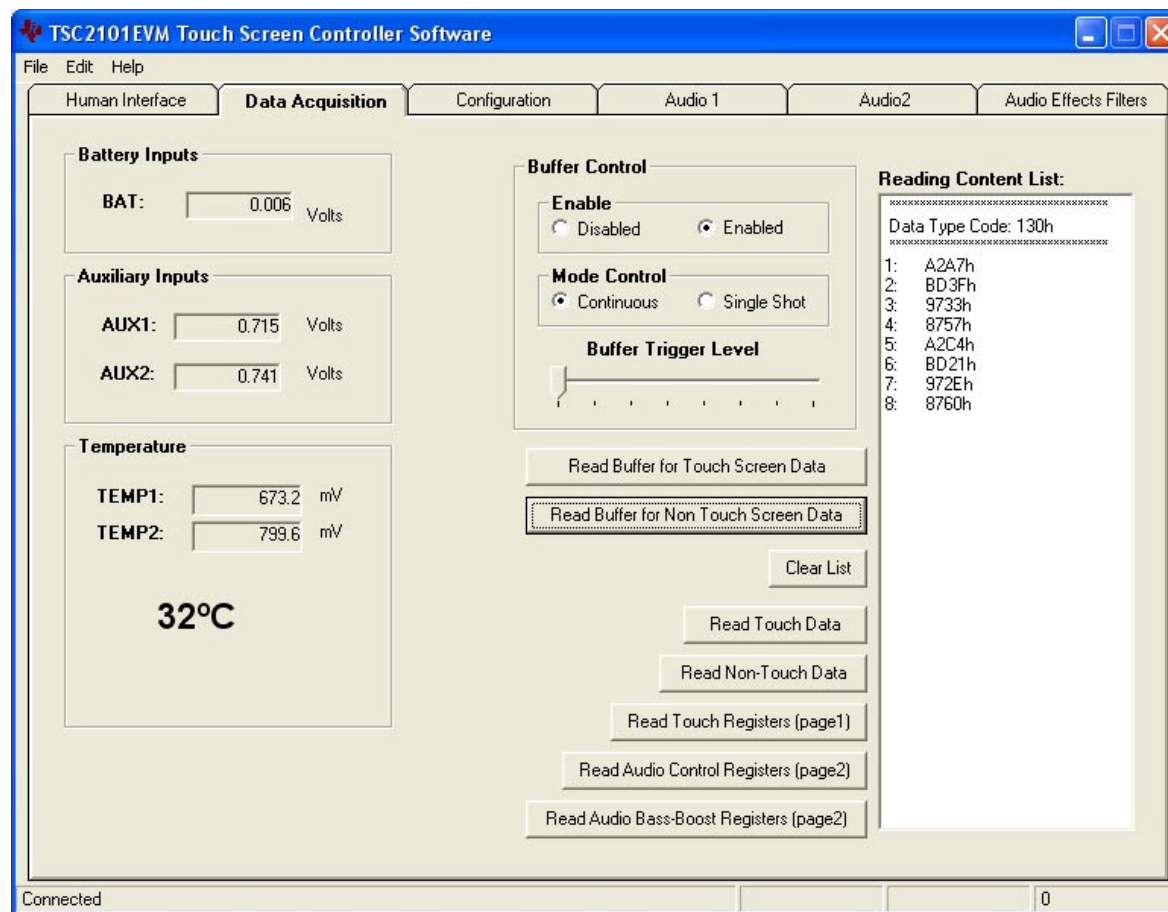

With this EVM, the buffer trigger level is either 8 or 16, selected by the *Buffer Trigger Level* selection slide. Even though the TSC2101 can be set to a higher trigger level up to 64, this EVM allows only 8 or 16. The buffer function can be controlled in either Continuous or Single Shot mode, which is selected on the mode control option box. Refer to the data sheet for more on TSC2101 buffer function.

The data in the list is cleared by clicking on the *Clear List* button on this screen.

3.5.2.3 Register Readings

Five additional register reading buttons trigger the lead corresponding registers and move the raw data into the list. This is helpful for testing and debugging.

3.5.3 Configuration Screen

This screen accesses all the configurable settings for the TSC2101 A/C converter and reference as shown in Figure 3–7.

Figure 3–7. Configuration Screen

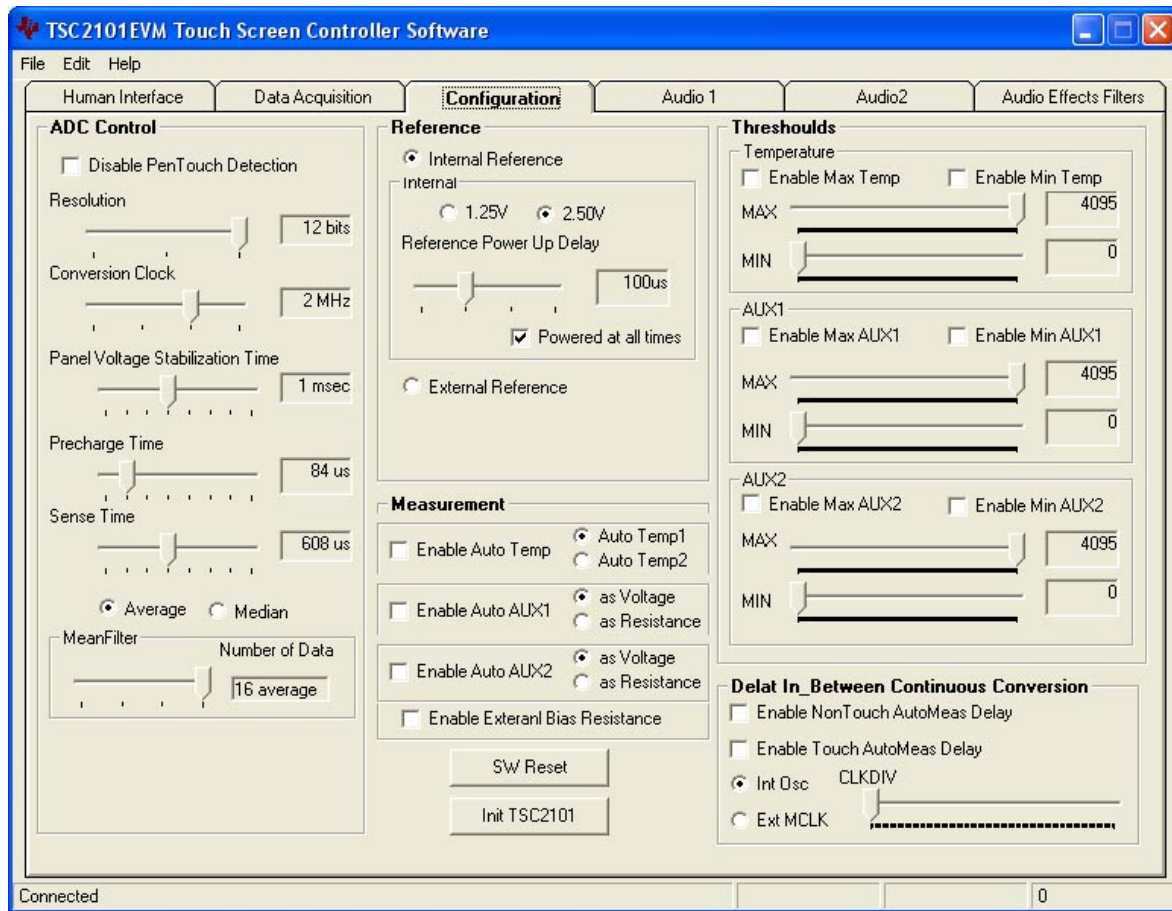

3.5.3.1 ADC Control Section

This section controls all of the parameters of the A/D converter. Each slider controls one parameter, whose value is shown next to the slider. Each slider is described as follows.

- Resolution**—Selects between 8-, 10-, and 12-bit resolution.
- Conversion Clock**—The internal clock which runs the A/D converter can run at 8, 4, 2, or 1 MHz. When running at 8 MHz, only 8-bit resolution is possible; when running at 4 MHz, 8- or 10-bit resolution is possible, but 12-bit is not. These restrictions are reflected in the operation of this program, because only 1- or 2-MHz clock rates allow 12-bit resolution to be chosen.
- Panel Voltage Stabilization Time**—This is the time that the TSC2101 allows for the touch screen to settle after turning the drivers on.
- Precharge Time and Sense Time**—These two parameters are the time allowed to precharge the touch panel capacitance and then sense to see if the screen is touched. For more details on these parameters, refer to the TSC2101 data sheet.

- Average/Median**—There are two ways to reduce noise effect to the ADC result. One is averaging, where 4, 8, or 16 readings are averaged; another option is to find the median value among 5, 9, or 15 readings. The default is the average mode, as shown in Figure 3–7. When Median mode is selected, you see the configuration tab as shown in Figure 3–8.

Figure 3–8. Configuration Screen at Median Mode

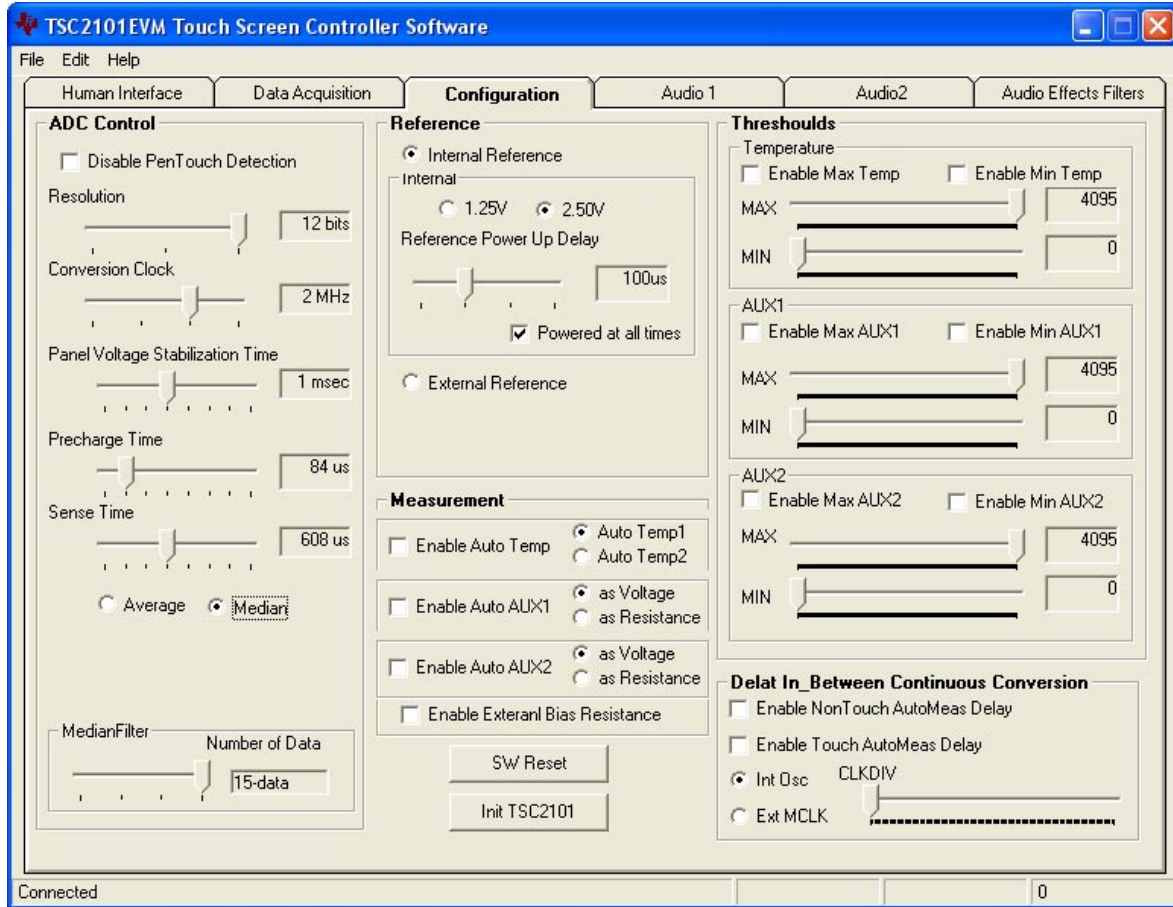

Note that these settings apply to all operations of the A/D converter, not just the touch screen operations. Thus, resolution and averaging can be changed to increase accuracy in the data acquisition functions.

3.5.3.2 Reference Section

The touch screen function is always performed using a ratiometric mode; for all other A/D functions, a reference voltage is needed for the A/D converter. Figure 3–7 and Figure 3–8 show this section with the TSC2101 internal reference chosen.

The internal reference voltage can be set to either 1.25 V or 2.5 V. The internal reference powers down between conversions to save power if the *Powered at all times* checkbox is not checked. Using the *Powered at all times* checkbox, this can be overridden and the reference does not power down. If the reference is allowed to power down, the TSC2101 must allow a delay time for the reference to power up when a conversion is to take place. This delay time can be set using the slider in this section.

If an external reference is to be used, it can be selected as shown in Figure 3–9. The value of the external reference should be entered in the text box shown.

Figure 3–9. Configuration Screen With External Reference Selection

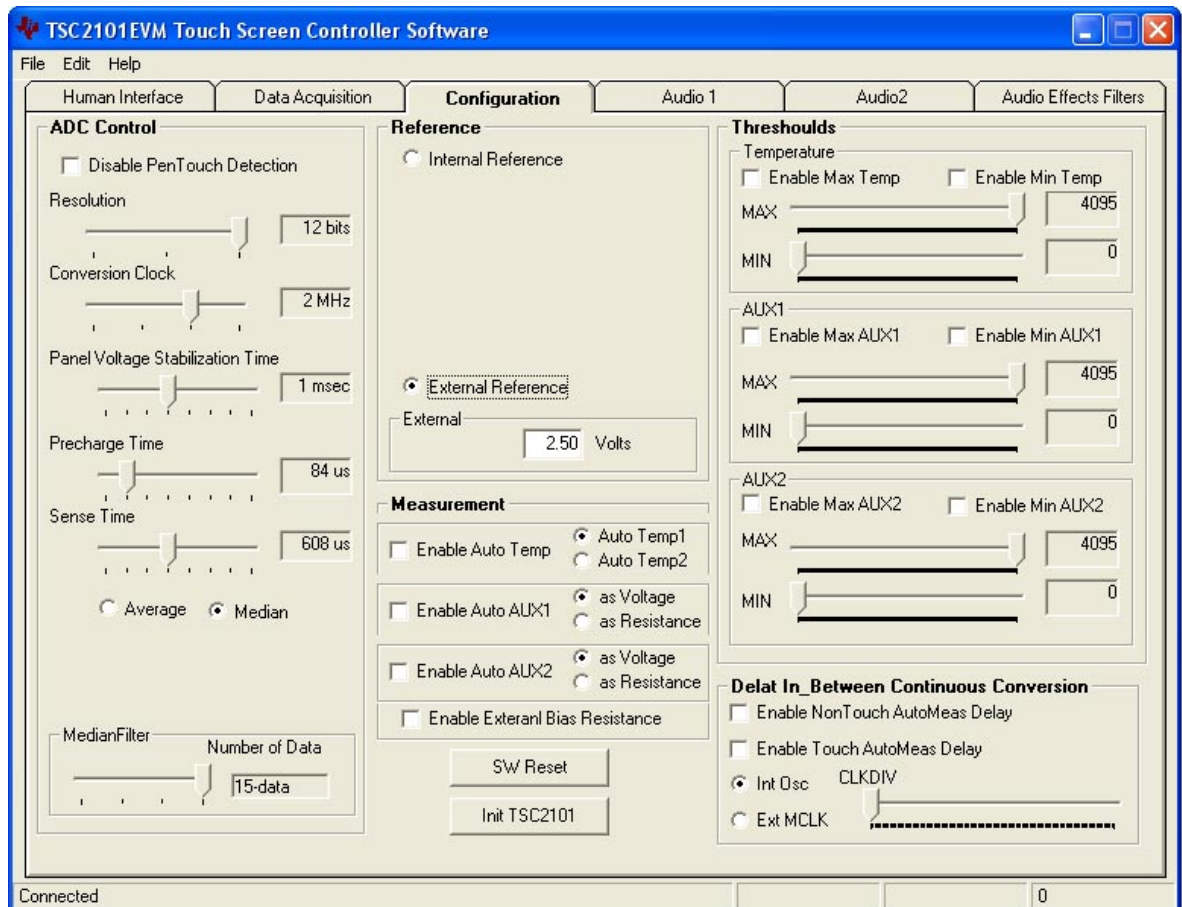

3.5.3.3 Measurement Section

The TSC2101 supports programmable auto-temperature and auto-auxiliary measurement mode. In the auto measurement mode, the TSC2101 can auto start the TEMP1, TEMP2, AUX1, and/or AUX2 measurement after a programmable interval. The checkboxes in the Measurement section provide choices.

Additionally, the AUX1 and AUX2 can be configured to measure voltage or resistance. Under the resistance measurement, the bias can be configured as external or internal by checking or unchecking the box *Enable External Bias Resistance*.

3.5.3.4 Threshold Section

Another feature with the temperature and auxiliary input measurements in TSC2101 is that the maximum and minimum of the analog input can be set up so that whenever the corresponding input signal goes outside the thresholds, the corresponding flags are set.

In this section, if the threshold function has not been enabled, that is the *Enable* checkbox has not been checked, the corresponding MAX/MIN slider does not move. Also note that the MAX value must be larger or equal to the MIN value.

3.5.3.5 Continuous Conversion Delay Section

In the auto measurement mode, the delays between the conversions are programmable. This section can be used to program to delays between the continuous conversions.

The nontouch and touch auto measurement delays can be programmed individually. Whenever the delay is enabled, by clicking on the corresponding checkbox, the delay-time option shows up for the selection.

The clock used here can be the internal oscillator or the external MCLK. The clock divider (CLKDIV) is used to get 1-MHz clock for the programmable delay. This sets the CLKDIV so that $MCLK/CLKDIV = 1 \text{ MHz}$.

3.5.3.6 Reinitialization and Reset

Two buttons on this screen allow the user to reset and reinitialize the TSC2101.

By clicking the button SW Reset , a software device reset is issued to the TSC2101. By clicking the button Init TSC2101 , the control registers (for ADC and audio) revert back to the startup (firmware) default settings.

To bring the TSC2101 EVM back to its power-up status, you can click SW Reset, followed by Init TSC2101 .

3.5.4 Audio Screens

Three tabs control the TSC2101 audio functions: *Audio 1*, *Audio 2*, and *Audio Effects Filters* tabs.

Figure 3–10 shows the default condition of the Audio 1 tab with the following sections:

- INTERFACE: set up the audio I²S port
 - PLL: set up PLL parameters to get the desired FSref frequency
 - ADC: set up the audio ADC, and select the ADC input source
- DAC/Outputs: set up the audio DAC and the all analog output features
 - GPIO1: set up GPIO1 function/status
 - GPIO2: set up GPIO2 function/status

Figure 3–10. Audio 1 Screen at Default

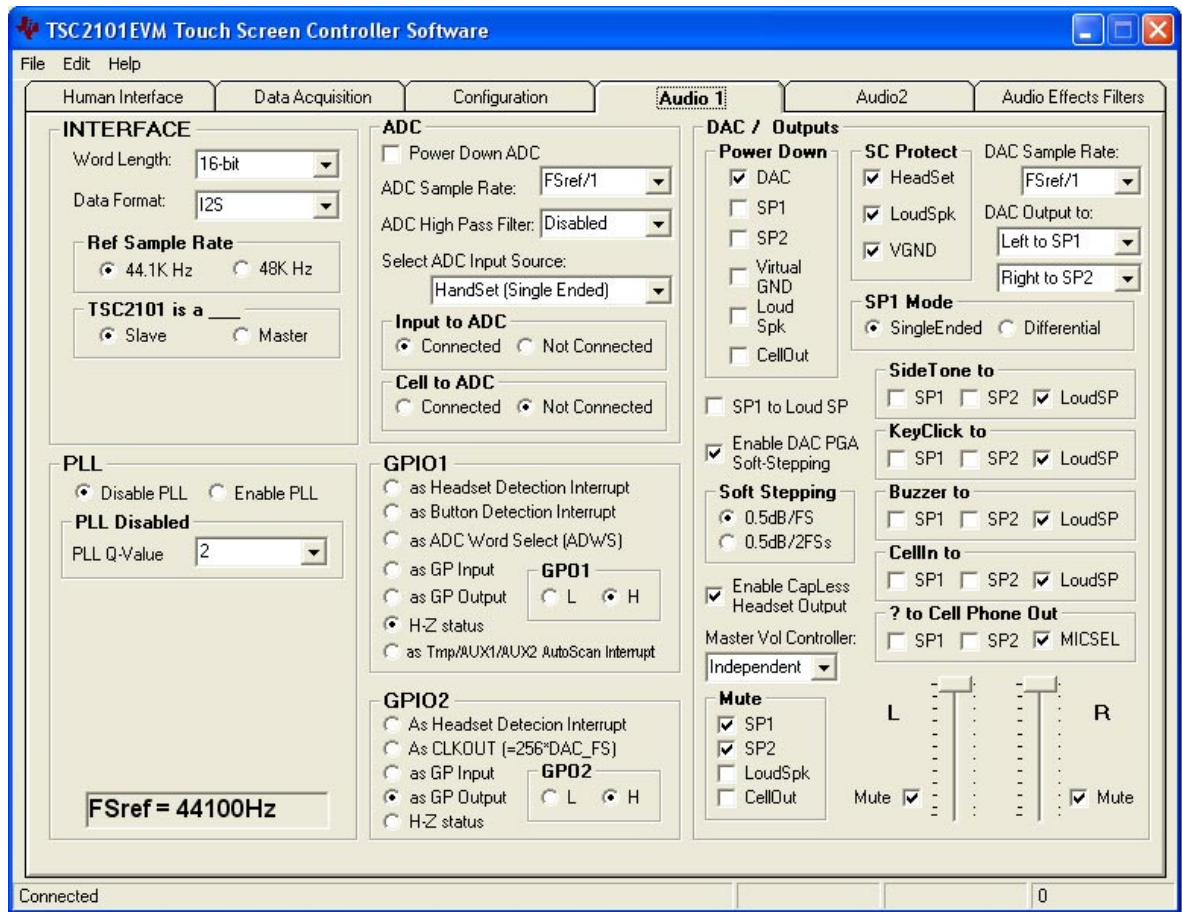

Figure 3–11 shows the default condition of the Audio 2 tab. The functions and setting on Audio 2 mainly control the audio analog inputs with the following sections:

- HeadSet: set up the headset input power and gain control (PGA or AGC) function and other headset specified functions.
- HandSet: set up the handset input power and gain control (PGA or AGC) function and other handset specified functions.
- Cell Phone: set up the cell-phone input power and gain control (PGA or AGC) function.
- SideTone: set up the sidetone power and gain.
- KeyClick: set up the key-click tone.
- Buzz Input: set up the power and gain for the input from the BUZZ_IN pin.

Figure 3–11. Audio 2 Screen at Default

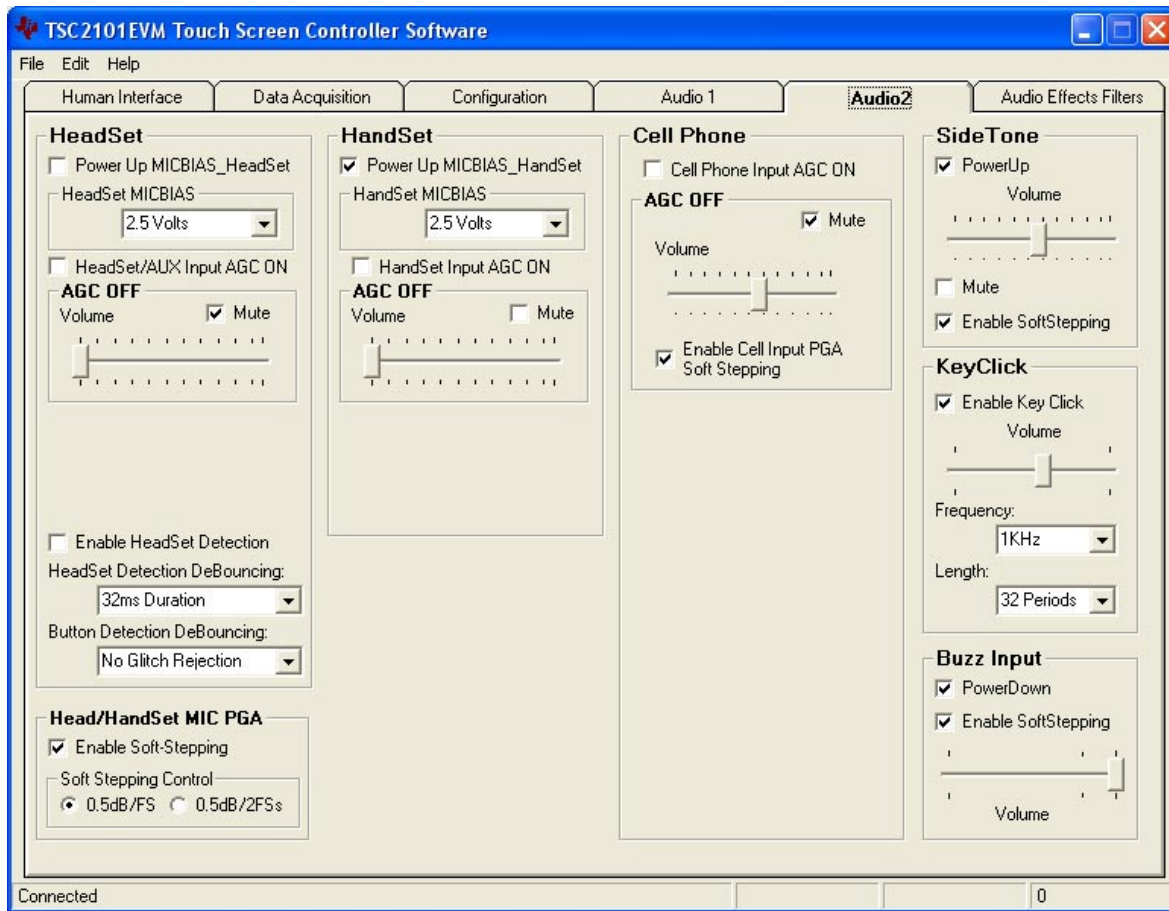
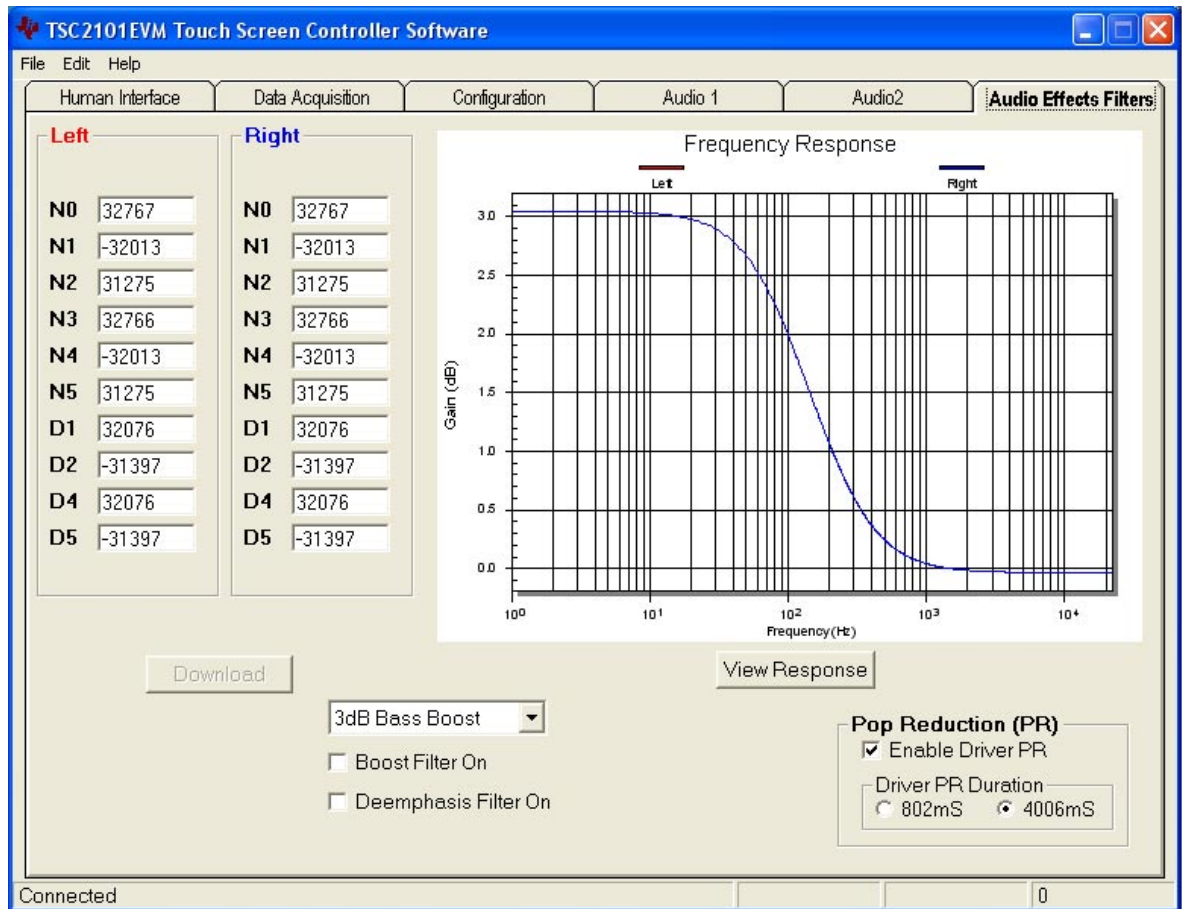

Figure 3–12 shows the default condition of the AudioEffects Filters tab. This tab displays the boost filters, the de-emphasis filter, and the DAC and output driver *pop* noise reduction functions.

Figure 3–12. Base Boost Filter Screen at Default



3.5.4.1 Interface Section

This section (refer to Figure 3–10) controls the behavior of the I²S port (BCLK, LRCLK, DIN, and DOUT pins). In this EVM, the audio port transfers the 16 bit data in I²S format, and the codec reference sample rate is at 44.1 kHz.

The TSC2101 is programmed as a slave by default. The onboard processor TAS1020B is the *master*, which generates the BCLK and LRCLK signal.

If the TSC2101 is used as a master, the onboard processor should be disabled and the I²S port should be *detached* from the processor by turning OFF the onboard I²S interface. Refer to the previous chapter for the hardware settings.

3.5.4.2 PLL Section

There is an on-chip phase-locked loop (PLL) on the audio codec part of the TSC2101. The PLL can be enabled or disabled, based on the given master clock (MCLK) to the TSC2101 and the required reference frequency (FSref) for the codec. For more details on the PLL, refer to the TSC2101 data sheet. The PLL can be set on the PLL Section of Audio 1 screen (Figure 3–10).

With the EVM board, the MCLK is at 11.2896 MHz, and the reference sample rate is at 44.1 kHz by default.

On the bottom of the section, the corresponding FSref frequency is shown based on the selection of:

- 1) the Q-value if the PLL has not been enabled, or
- 2) the P, J, D values if the PLL has been enabled.

3.5.4.3 ADC Section

This section (Audio 1 Tab, Figure 3–10) sets up the audio ADC power and the analog input source.

By default, the audio ADC has been powered up so that the audio recording function can start to run with any SW settings. By checking Power Down ADC, audio ADC power is disabled.

The ADC sample rate can be set as a divider frequency from the reference frequency, FSref. For example, when FSref = 44.1 kHz (set at the INTERFACE section of the same tab), an 8-K sample rate is achieved by setting the divider to 5.5 ($44100/5.5 = 8018$ Hz).

The audio ADC also has a high-pass filter, which is a submultiple of the sample rate, to remove dc or low frequency components from the input signal.

The input signal to the audio ADC can be obtained from different analog resources and under a different mode, selectable from the *Select ADC Input Source* option list. The microphone input from the headset or the handset can be selected; the single-ended or the differential input (paired with AUX1 or AUX2) can be used.

Also, there is the option to connect the above selected signal or the cell-phone input to the audio ADC.

3.5.4.4 DAC/Outputs Section

This section sets up the audio DAC power and all functions of the analog outputs, such as the power, the gain control, and the destination, which identifies the analog output pin or pins where the analog output signal is sent.

In the *Power Down* subsection, the DAC and the output driver circuits can be powered up/down individually. By checking a checkbox, the corresponding TSC2101 circuit is powered down.

In the *SC Protect* subsection, the short-circuit (SC) protection function can be enabled or disabled. When the short-circuit protection function is enabled and a short-circuit occurs, all analog outputs are disabled and the corresponding flag is set. For example, to set the headset SC protection, check the box. In the event of a headset short circuit, all analog outputs are disabled, and D1 of control registers in page 2 address 0x1D is set. The TSC2101 requires hardware or software reset to return to normal operation.

Similar to the ADC, the DAC sample rate can be set as a divider frequency from the reference FSref frequency, through the *DAC Sample Rate* option list.

The TSC2101 has the capability to route the stereo DAC output signals to any of the selected analog output. To route the signals to the headset drivers (SP1

and SP2 pins), select from the *DAC Output to* lists. By default, the left channel DAC output is routed to SP1 and the right channel to SP2.

The signal routed to SP1 can also be output to the loud speaker (OUT8P/OUT8N), if the *SP1 to Loud SP* checkbox is checked.

The SP1 can be used in single-ended or differential mode. In the single-ended mode, it is driven as one channel of the stereo headset outputs, and the audio sound is received through a headset that has been plugged into the jack J7 on the EVM. In the differential mode, the SP1 is paired with the OUT32N pin as the *receiver driver*, and the audio sound is received through a speaker that has been connected to the terminal block J8 on the EVM. Note that the receiver driver and the headphone drivers are not allowed to be turned on at the same time. By default, the SP1 is set to single-ended mode.

Besides the DAC outputs, other inputs, such as the SideTone, KeyClick, CP_IN, and BUZZ_IN can be routed to speaker 1 (SP1), speaker 2 (SP2), and/or the loud speaker (LoudSP). The routing among these signals can be done on this section by clicking on the corresponding checkbox. The signals to SP1, SP2, or the ADC can be output to the TSC's cellphone output pin.

Like the audio ADC gain controls, the DAC PGA gain, can be set to soft-stepping mode. Under the soft-stepping mode, the *soft stepping* can be set to either 0.5-dB per one sample, or 0.5-dB per two samples.

The stereo DAC audio volumes is controlled three different ways by the left (L) and right (R) volume control slides, selectable through setting the master volume controller: 1) independent, 2) right channel controlled, or 3) left channel controlled.

In addition to the left and right DAC channel volume controls and mutes, the analog signals from the SPK1, SPK2, OUT8P/OUT8N (loud speaker), and CP_OUT pins can be individually muted or unmuted.

TSC2101 supports both capacitor-coupled (cap) and capacitor-less (capless) interfaces for headset through software. Check the box *Enable Capless Headset Output* to turn on the capless outputs. Note that SW3 on the EVM board is associated with the software setting to have the proper cap or capless audio outputs on the EVM.

3.5.4.5 GPIO1 and GPIO2 Sections

The two GPIO pins on the TSC2101 are programmed for several different functions, selectable through the GPIO1 or GPIO2 section. Refer to the data sheet for all of the functions. When a GPIO pin is used as a digital output, its status can be controlled by the *GPO Command* to either logic high or low. When not being used, the GPIO pin should be put on high impedance (Hi-Z) status.

3.5.4.6 Headset Section

The headset section is in the Audio 2 tab, which is used mainly to set up the headset input gain through the headset PGA or the AGC, selectable by the *Headset/AUX Input AGC ON* checkbox.

By default, the AGC is OFF and the programmable gain amplifier (PGA) on the headset circuit is selected for the gain control, allowing analog input gain control from 0 dB to 59.5 dB. When the AGC is OFF, moving the volume slide on the *AGC OFF* subsection adjusts the PGA on the MICIN_HED path and checking the Mute box mutes the headset input signal.

When the PGA changes from the current value to a newly programmed value, the change rate can be controlled if the PGA Soft Stepping box is checked in the *Head/Handset MIC PGA* section, where the PGA changes 0.5 dB at either 1 step per sample or one step per two samples.

When the box by AGC ON is checked, the AGC is enabled and all of the options or settings for programming the AGC are now accessible, as shown in Figure 3–13. Refer to the TSC 2101 data sheet for setting and using the AGC.

Figure 3–13. Audio 2 Screen With Headset AGC On

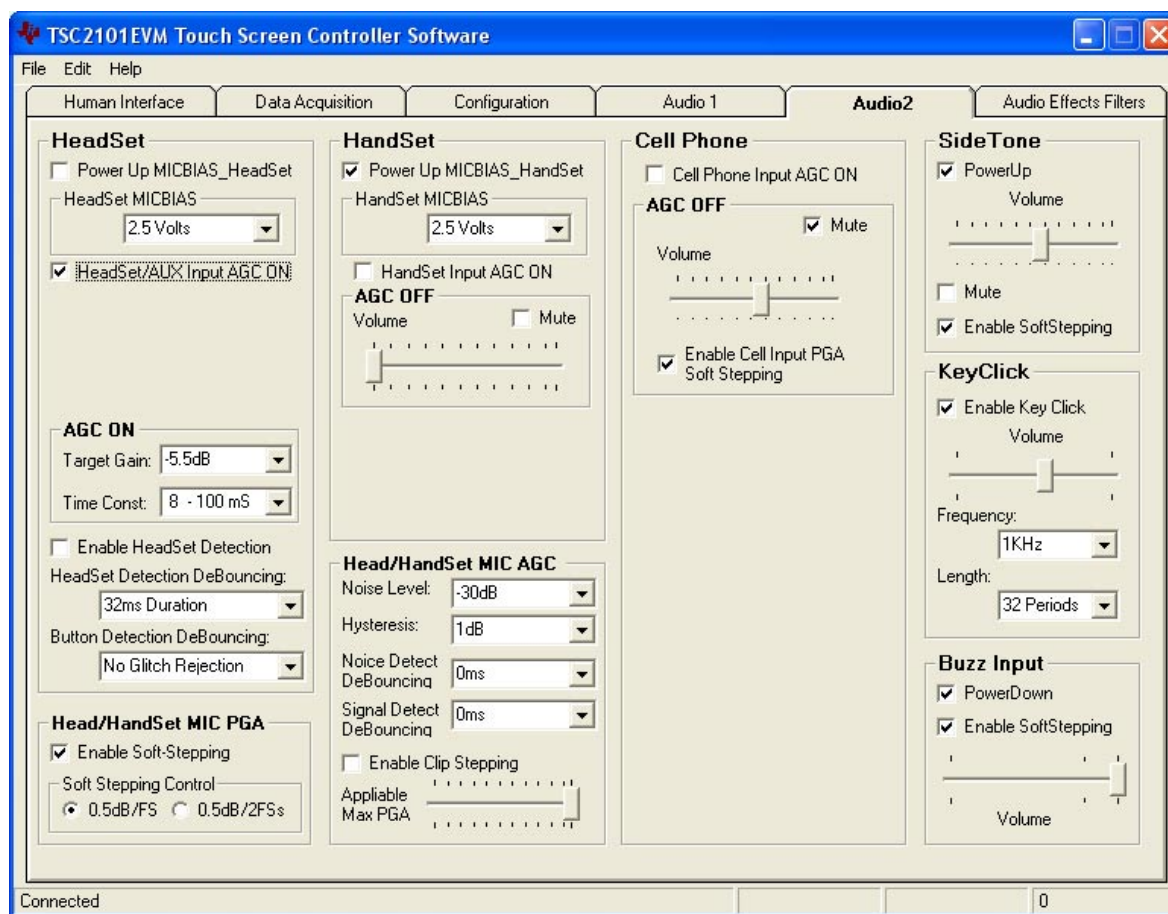

In addition to the input gain control, the headset microphone bias can be selected. The programmable de-bounce features for the headset and button detect can also set up in this section. Refer to data sheet for the details on the detection and de-bounce.

3.5.4.7 Handset Section

Similar to the headset section, the handset section is used mainly to set up the handset input gain through the handset PGA or the AGC, selectable by the *Handset Input AGC ON* checkbox.

By default, when the handset AGC is OFF, and the programmable gain amplifier (PGA) is selected for the input gain control, allowing analog input gain control from 0 dB to 59.5 dB. Under the case (AGC OFF), moving the volume slide on the *AGC OFF* subsection adjusts the PGA on the MICIN_HND path and checking the Mute box mutes the handset input signal.

The handset and headset share the soft-stepping settings. Refer to the explanation in the *Headset Section* for the feature and settings.

Similar to the headset, when the box by AGC ON is checked, the handset AGC is enabled, as shown in Figure 3–14. Refer to the TSC 2101 data sheet for setting and using the AGC.

Figure 3–14. Audio 2 Screen With Handset AGC On

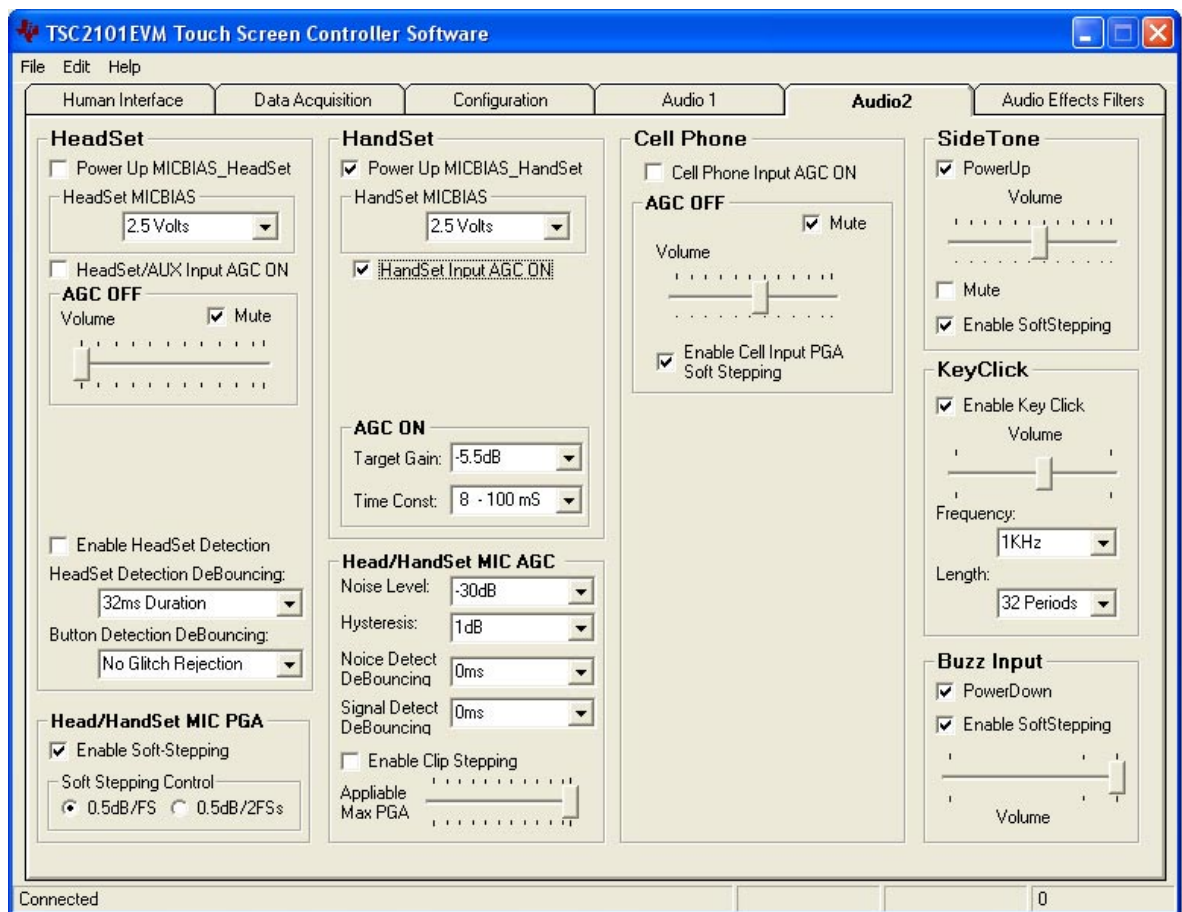

In addition to the handset input gain control, the handset microphone bias can be selected inside the Handset Section, similar to that in the *Headset Section*.

3.5.4.8 Cell-Phone Section

The cell-phone section is used to set up the cell-phone input gain, by using the CP_IN PGA or AGC.

When the checkbox by *Cell Phone Input AGC ON*, is not checked, the PGA controls the gain, from -34.5 dB to 12 dB, and in 0.5 dB steps if the soft-stepping option was selected. The cell-phone input is muted when the Mute box under the slider is checked.

When the box by AGC ON is checked, the cell-phone input AGC is enabled, as shown in Figure 3–15. Refer to the TSC 2101 data sheet for setting and using the AGC.

Figure 3–15. Audio 2 Screen With Cell-Phone AGC On

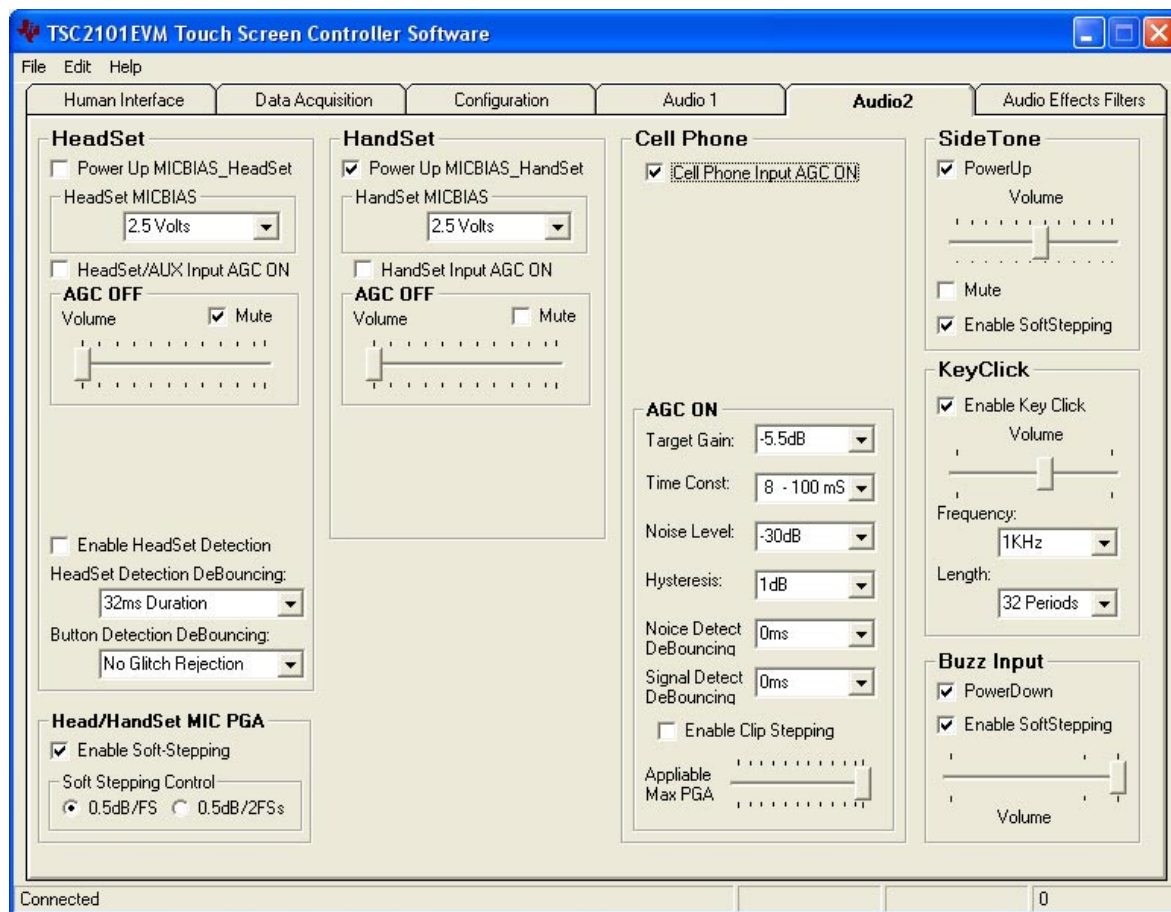

3.5.4.9 Sidetone Section

The TSC2101 has an analog sidetone circuit. The audio outputs of the TSC2101 includes a mix so that the sidetone can be mixed with the audio output signals, in proportion to their respective volume settings.

The sidetone is enabled when the PowerUp box is checked. Its volume can be adjusted by the analog volume control slider, ranging from -34.5 dB to 12 dB, and in 0.5 -dB steps if the soft-stepping option is used. The sidetone is muted when the Mute box under the slider is checked.

At the EVM power up, the sidetone is defaulted to power up.

3.5.4.10 Keyclick Section

When the *Enable Key Click* box is checked, a clicking sound is heard whenever an audio-related setting is selected or checked in the Audio 1, Audio 2 and the Audio Effects Filters screens.

The volume, frequency, and duration (length) of this keyclick can be adjusted using the corresponding slider and selectors.

At the EVM power up, the keyclick is enabled by default.

3.5.4.11 Buzz Input Section

The buzzer input from the cell phone can be routed to TSC2101 through the BUZZ_IN pin, if the checkbox by PowerDown is not selected. This input path supports the PGA range of from -45 dB to 0 dB, and in 3 dB steps if the soft-stepping option was chosen.

3.5.4.12 Audio Effects Filters Screen

The Audio Effects Filters screen displays all of the coefficients for the boost filter function of the TSC2101. These coefficients are programmable. Refer to the default Audio Effects Filters Screen shown in Figure 3–12.

Different filter coefficients can be loaded for left and right channels, although usually these are set the same. Figure 3–16 shows an example with the different left and right channel filters.

Figure 3–16. Bass Boost Filter Screen With Different Left/Right Channels

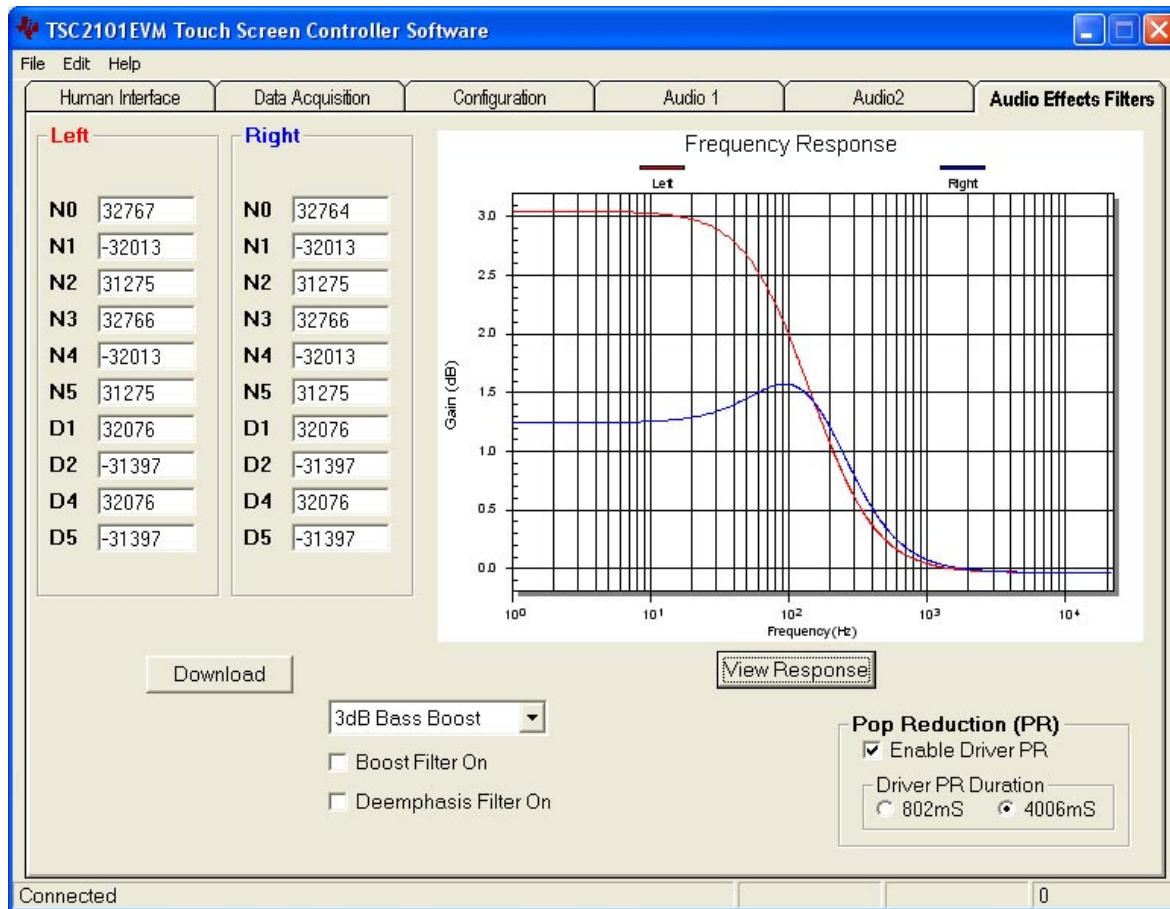

If changes are made to coefficient values directly, the response can be viewed on the graph by pressing the *View Response* button. It is recommended that the user view the response before downloading values to the TSC2101, as some values can cause clipping or oscillation of the filter. The filter equation is described in the TSC2101 data sheet. When the entered data is outside the range, a warning window appears to indicate the improper coefficient entered, as shown in Figure 3–17.

Figure 3–17. Bass Boost Filter Screen With Bad Data

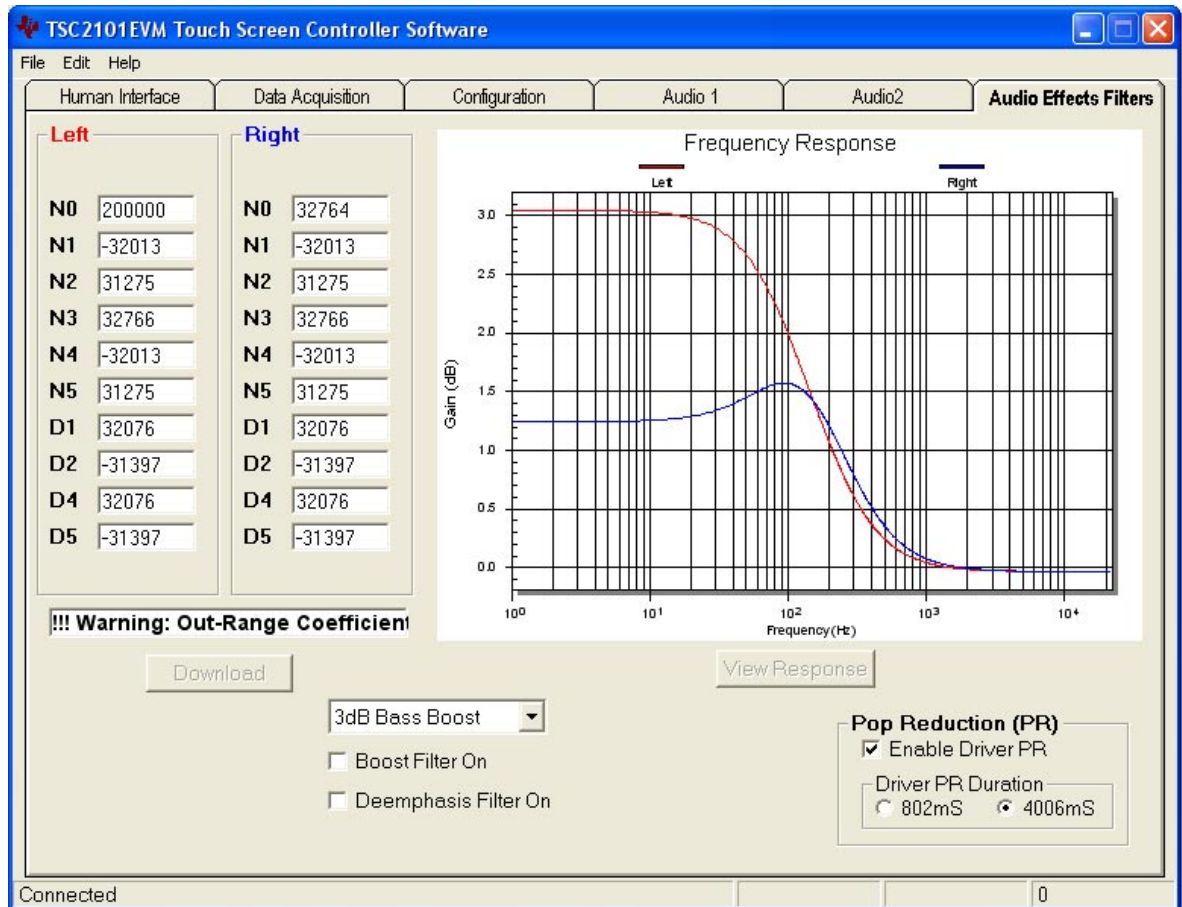

In addition to the direct coefficient settings previously described, there are six preconfigured filters designed with the EVM software, selectable using the drop-down list of this screen, refer to Figure 3–18. On selection, the coefficients are updated along with the graph of the filter response to the selection. However, nothing is loaded into the TSC2101 until the Download button is pressed.

Checking the *Boost Filter* box enables the filter selected.

In addition to the boost filter, is another digital filter, the de-emphasis filter is provided by TSC2101 for the audio DAC. Checking the *Deemphasis Filter On* box enables the filter.

Settings on this tab can reduce the *pop* noise heard at the moment the power supply (-ies) is brought up to the TSC2101. The pop noise reduction can be set on the DAC or the analog output driver circuit. Click on the *Enable DAC PR* checkbox to enable the DAC pop reduction feature. Click on the *Enable Driver PR* checkbox to enable the output driver pop reduction feature. Set the *Clock Frequency* and duration to change and optimize the noise reduction effects.

Figure 3–18. Bass Boost Filter Screen With Boost Filter Selection

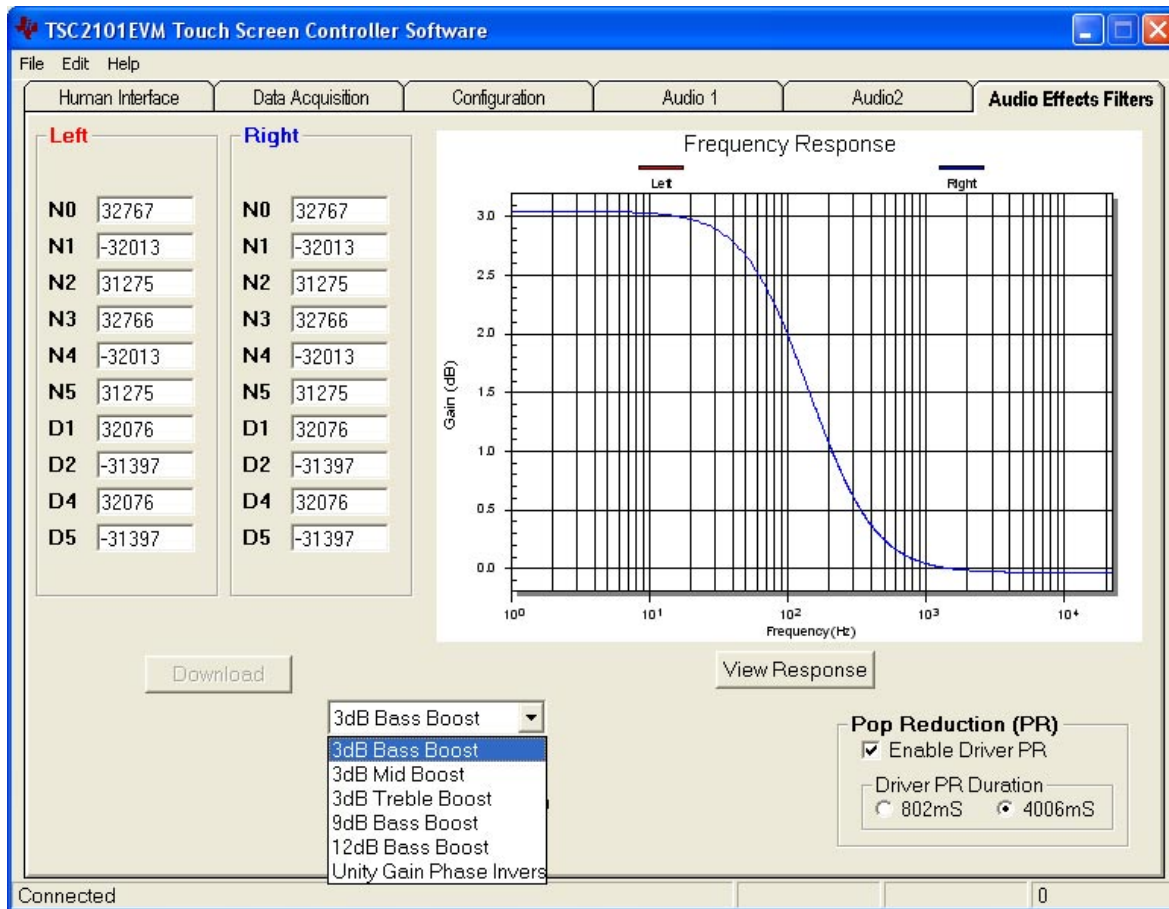

Physical Description

This chapter contains the bill of materials, the EVM board silk screen/top layer, and the schematics.

Topic	Page
4.1 Bill of Materials	4-2
4.2 EVM Silk Screen/Top Layer	4-5
4.3 Schematics	4-6

4.1 Bill of Materials

Item No.	Qty	Value	Ref Des	Description	Vendor	Part Number
1	6	0	R1–R4, R6, R7	1/8W 5% Chip resistor	Panasonic	ERJ–6GEY0R00V
2	1	0	R20	1/4W 5% Chip resisto	Panasonic	ERJ–8GEY0R00V
3	1	10	R37	1/16W 1% Chip resistor	Panasonic	ERJ–3EKF10R0V
4	2	27.4	R35, R36	1/16W 1% Chip resistor	Panasonic	ERJ–3EKF27R4V
5	2	220	R38, R39	1/10W 5% Chip resistor	Panasonic	ERJ–3GEYJ221V
6	1	220	R5	1/8W 5% Chip resistor	Panasonic	ERJ–6GEYJ221V
7	1	270	R43	1/10W 5% Chip resistor	Panasonic	ERJ–3GEYJ271V
8	1	649	R40	1/16W 1% Chip resistor	Panasonic	ERJ–3EKF6490V
9	1	680	R28	1/4W 5% Chip resistor	Panasonic	ERJ–8GEYJ681V
10	1	1.5 k	R34	1/10W 5% Chip resistor	Panasonic	ERJ–3GEYJ152V
11	1	2.2 k	R29	1/4W 5% Chip resistor	Panasonic	ERJ–8GEYJ222V
12	3	2.7 k	R18, R19, R21	1/10W 5% Chip resistor	Panasonic	ERJ–3GEYJ272V
13	1	2.7 k	R17	1/4W 5% Chip resistor	Panasonic	ERJ–8GEYJ272V
14	4	3.09 k	R30–R33	1/16W 1% Chip resistor	Panasonic	ERJ–3EKF3091V
15	1	30.1 k	R42	1/16W 1% Chip resistor	Panasonic	ERJ–3EKF3012V
16	1	69.8 k	R41	1/16W 1% Chip resistor	Panasonic	ERJ–3EKF6982V
17	6	100 k	R22–R27	1/10W 5% Chip resistor	Panasonic	ERJ–3GEYJ104V
18	2	10 k	RA1, RA2	1/16W 5% 4-resistor array, 8 terminal	CTS Corporation	742C083103JTR
Not Installed	9		R8–R16			
19	2	33 pF	C41, C42	50-V Ceramic chip capacitor, ±5%, NPO	Panasonic	ECJ–1VC1H330J
20	2	47 pF	C37, C38	50-V Ceramic chip capacitor, ±5%, NPO	Panasonic	ECJ–1VC1H470J
21	1	100 pF	C43	50-V Ceramic chip capacitor, ±5%, NPO	Panasonic	ECJ–1VC1H101J
22	1	1000 pF	C44	50-V Ceramic chip capacitor, ±10%, X7R	Panasonic	ECJ–1VB1H102K
23	12	0.1 μF	C8–C16, C31, C32, C40	16-V Ceramic chip capacitor, ±10%, X7R	Panasonic	ECJ–1VB1C104K
Not Installed	7	0.1 μF	C1–C5, C7	16-V Ceramic chip capacitor, ±10%, X7R	Panasonic	ECJ–2VB1C104K
24	2	0.1 μF	C29, C30	16-V Ceramic chip capacitor, ±10%, X7R	Panasonic	ECJ–3VB1C104K
25	2	0.33 μF	C39, C47	10-V Ceramic chip capacitor, ±10%, X5R	Panasonic	ECJ–1VB1A334K
26	10	1 μF	C17, C33–C36, C48–C51, C55	16-V Ceramic chip capacitor, ±10%, X5R	Panasonic	ECJ–1VB1C105K
27	12	10 μF	C18–C20, C23–C28, C45, C46, C57	6.3-V Ceramic chip capacitor, ±10%, X5R	Panasonic	ECJ–3YB0J106K
28	2	47 μF	C21, C22	6.3-V Ceramic chip capacitor, ±20%, X5R	Panasonic	ECJ–4YB0J476M

Item No.	Qty	Value	Ref Des	Description	Vendor	Part Number
Not Installed	3		C52, C53, C54			
29	1		D1	50-V, 1-A diode SMD	Micro Commercial Corp.	DL4001
30	1		D2	Red LED, SMD	Lumex	SML-LX0603IW-TR
31	1		D3	Yellow LED, SMD	Lumex	SML-LX0603YW-TR
32	3		D4-D6	Green LED, SMD	Lumex	SML-LX0603GW-TR
Not Installed	4		D7-D10	Schottky barrier diode, series configuration	Zetex	BAT54STA
33	1		MK1	Omnidirectional microphone cartridge	Knowles Acoustics	MD9745APZ-F
34	1		X1	6-MHz crystal, SMD	Epson	MA-505 6.000M-C0
35	1		U1	Touch screen controller, audio codec	Texas Instruments	TSC2101RGZ
36	1		U2	64K, I ² C EEPROM	Microchip	24LC64-I/SN
37	1		U3	Dual output LDO voltage regulator	Texas Instruments	TPS767D318PWP
38	1		U4	Dual output LDO voltage regulator	Texas Instruments	TPS767D301PWP
39	2		U5, U6	Quad IC buffer driver with 3-state output	Texas Instruments	SN74LVC125APW
40	4		U7, U8, U9	Single IC buffer driver with open drain o/p	Texas Instruments	SN74LVC1G07DBVR
41	1		U10	USB Interface to SPI™/I ² S™	Texas Instruments	TAS1020BPFB
42	1		N/A	TSC2101EVM PWB	Texas Instruments	6444330
43	3		J1, J2, J4	Screw terminal block, 4 position	On Shore Technology	ED555/4DS
44	4		J5, J8, J9, J11	Screw terminal block, 2 position	On Shore Technology	ED555/2DS
45	1		J3	Right angle 4 position socket	AMP/Tyco Electronics	103634-3
46	1		J6	3,5 mm audio jack, T-R-S, SMD	CUI Inc.	SJ-3515-SMT-1
47	1		J7	3,5 mm audio jack, T-R-S-G, Thru-Hole	CUI Inc.	SJ-43514
48	1		J12	2,5 mm Power Jack	CUI Inc.	PJ-102B
49	1		J10	USB type B socket, thru-hole	Mill-Max	897-30-004-90-000000
50	2		J13, J14	5 x 2 Position header, 0.1" spacing	Samtec	TSW-105-07-L-D
51	3		JMP5, JMP8, JMP9	2 Position jumper, 0.1" spacing	Samtec	TSW-102-07-L-S
52	3		JMP3, JMP6, JMP7	3 Position jumper, 0.1" spacing	Samtec	TSW-103-07-L-S
53	1		JMP4	3 X 2 Position header, 0.1" spacing	Samtec	TSW-103-07-L-D

Bill of Materials

Item No.	Qty	Value	Ref Des	Description	Vendor	Part Number
54	1		JMP2	Bus wire		
55	5		JMP1, JMP10, JMP11, JMP12, JMP13	Bus wire		
56	2		SW1, SW2	4 Position DIP switch, SMD half pitch	C&K	TDA04H0SK1
57	1		SW3	4 PDT right angle switch	E-Switch	EG4208
Not Installed	46		TP1-TP16, TP18-TP27, TP29-TP48	Miniature test point terminal	Keystone Electronics	5000
58	2		TP17, TP28	Miniature test point large loop terminal	Keystone Electronics	5011
59	8		N/A	Jumper top	Samtec	SNT-100-BK-T
60	4		N/A	0.25" × 0.625" Hex 4-40 threaded standoff	Keystone Electronics	1808
61	4		N/A	Pan head machine screw 4-40 × 1/2" phillips	Building Fasteners	PMS 440 0050 PH

4.2 EVM Board Silk Screen/Top Layer

Table 4-1. Top Board Layer Silk Screen

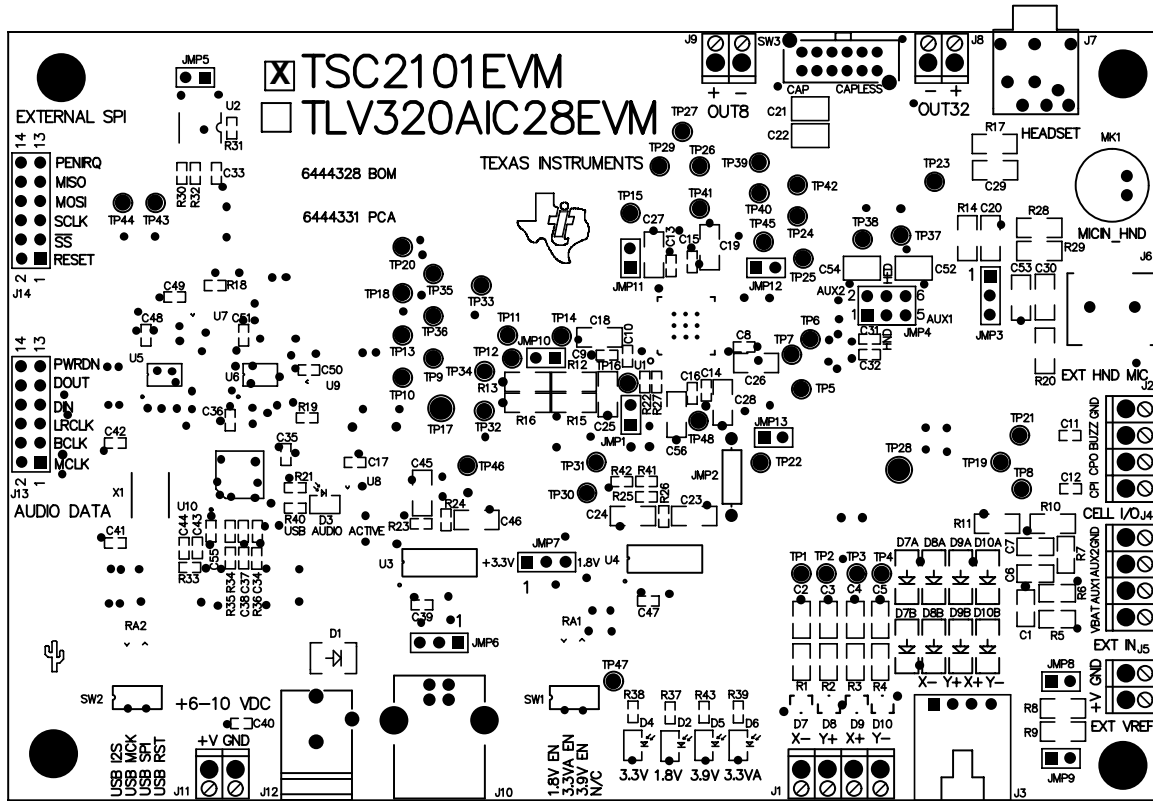

4.3 Schematics

Schematic diagrams of the TSC2101EVM showing the TSC2101 connections and the USB and connectors are shown on the following pages.

Revision History		
REV	ECN Number	Approved

PLEASE NOTE:
Components within dashed box are not included on the AIC28 version of the board.

D7 through D10 are not installed, but can be added for extra ESD protection, or for reducing touch panel noise.

JMP4 is used to select AUX inputs for differential microphone input mode.

C52, C53, and C54 are not installed, but can be used to filter noise on microphone bias outputs.

C1 through C7 are not installed, but can be added for noise filtering.

R12, R13, R15 and R16 are not installed, but can be used as pull ups or pull downs on the GPIO lines.

R8 through R11, JMP8 and JMP9 are not installed, but can be used for resistance measurements on the AUX pins.

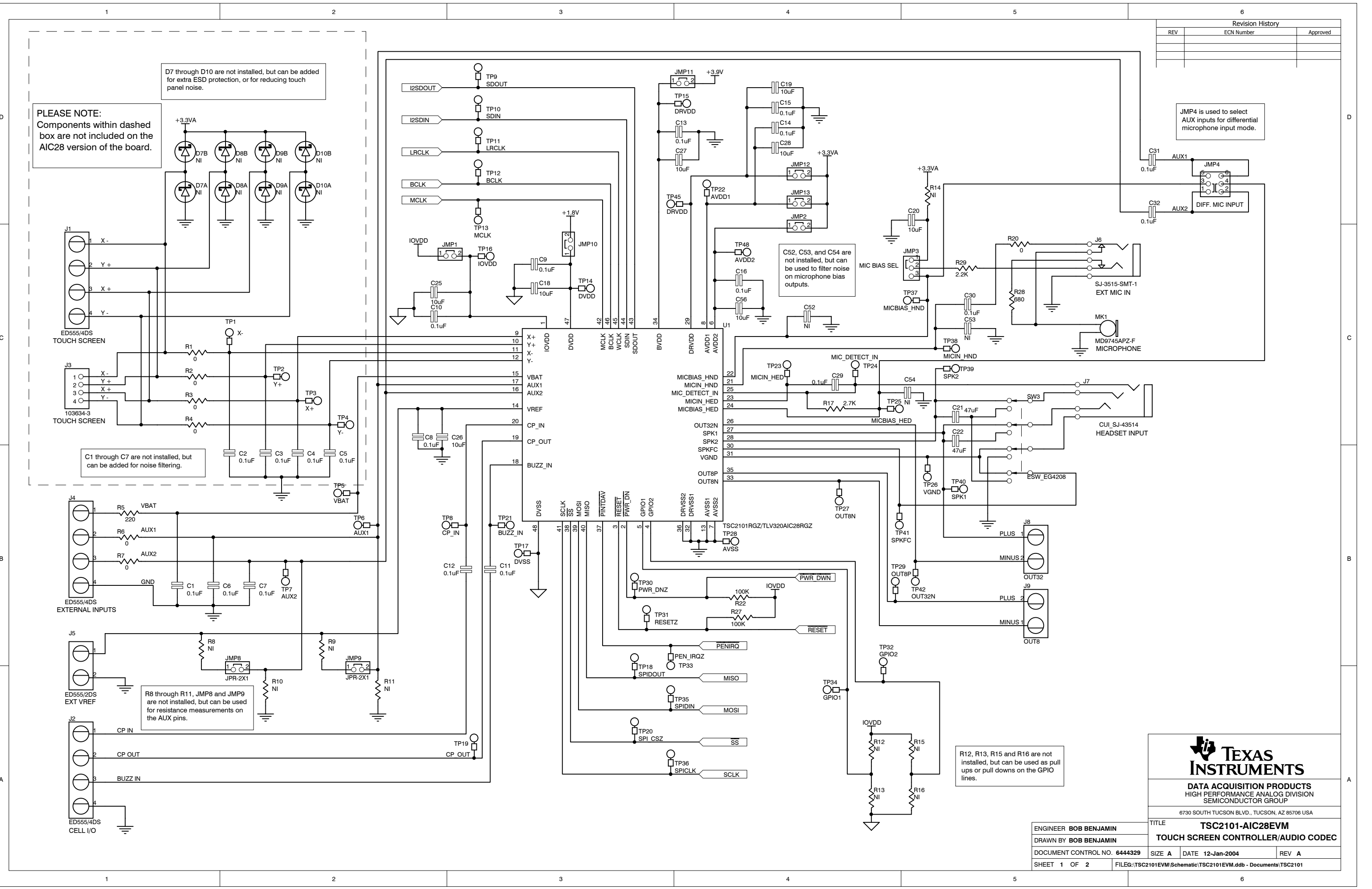

TEXAS INSTRUMENTS
 DATA ACQUISITION PRODUCTS
 HIGH PERFORMANCE ANALOG DIVISION
 SEMICONDUCTOR GROUP
 6730 SOUTH TUCSON BLVD., TUCSON, AZ 85706 USA

ENGINEER	BOB BENJAMIN	TITLE	TSC2101-AIC28EVM				
DRAWN BY	BOB BENJAMIN	TOUCH SCREEN CONTROLLER/AUDIO CODEC					
DOCUMENT CONTROL NO.	6444329	SIZE	A	DATE	12-Jan-2004	REV	A
SHEET	1 OF 2	FILE	TSC2101EVM.Schematic\TSC2101EVM.ddb - Documents\TSC2101				

REVISION HISTORY		
REV	ENGINEERING CHANGE NUMBER	APPROVED

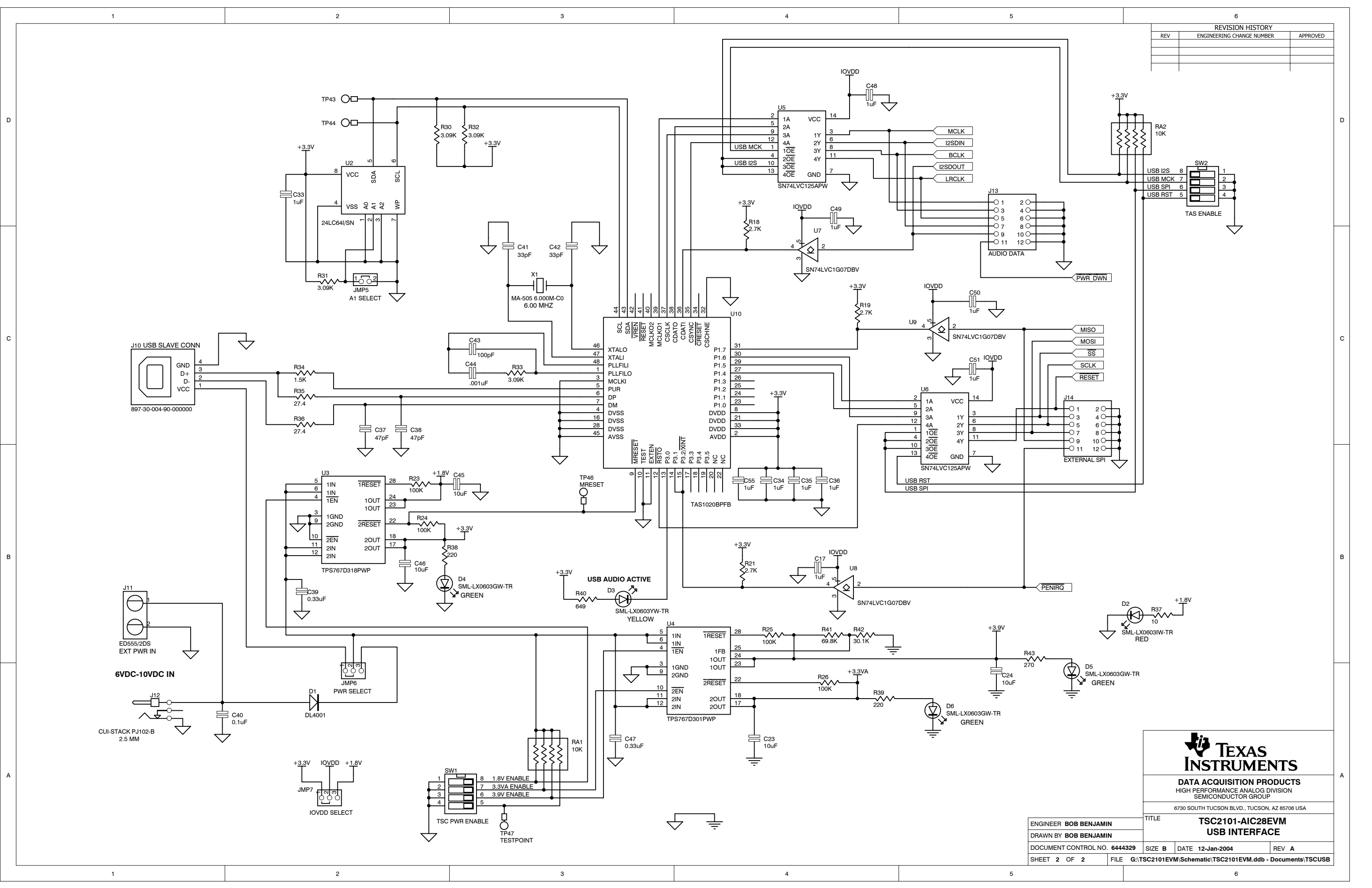

TEXAS INSTRUMENTS
 DATA ACQUISITION PRODUCTS
 HIGH PERFORMANCE ANALOG DIVISION
 SEMICONDUCTOR GROUP
 6730 SOUTH TUCSON BLVD., TUCSON, AZ 85706 USA

ENGINEER BOB BENJAMIN		TITLE TSC2101-AIC28EVM USB INTERFACE	
DRAWN BY BOB BENJAMIN		SIZE B	DATE 12-Jan-2004
DOCUMENT CONTROL NO. 6444329	REVISION A	REV A	
SHEET 2 OF 2		FILE G:\TSC2101EVM\Schematic\TSC2101EVM.ddb - Documents\TSCUSB	