

# TPS63020EVM-487

This user's guide describes the characteristics, operation, and use of the TPS63020EVM evaluation module (EVM). The EVM is designed to help the user easily evaluate and test the operation and functionality of the TPS63020. This user's guide includes setup instructions for the hardware, a schematic diagram, a bill of materials, and printed-circuit board layout drawings for the evaluation module.

## Contents

1	Introduction .....	1
2	Setup and Results .....	2
3	Board Layout .....	5
4	Schematic and Bill of Materials .....	7

## List of Figures

1	Turn ON Into Electronic Load .....	3
2	Output Ripple Vin 3 V .....	4
3	Output Ripple Vin 4 V .....	4
4	Efficiency Over Li-Ion Cell Range .....	5
5	Load Step 100 mA to 500 mA.....	5
6	Assembly Layer .....	6
7	Top Layer Routing .....	6
8	Bottom Layer Routing .....	7
9	Schematic.....	7

## List of Tables

1	Performance Specification Summary.....	2
2	TPS63020EVM-487 Bill of Materials .....	8

## 1 Introduction

The Texas Instruments TPS63020 is a highly efficient, single-inductor, buck-boost converter in a 14-pin, 3-mm x 4-mm QFN package. Both fixed and adjustable output voltage units are available.

### 1.1 Background

The TPS63020EVM-487 uses the TPS63020 adjustable version and is set to 3.3-V output. The EVM operates with full-rated performance with an input voltage between 1.8 V and 5.5 V.

### 1.2 Performance Specification

[Table 1](#) provides a summary of the TPS63020EVM-487 performance specifications. All specifications are given for an ambient temperature of 25°C.

**Table 1. Performance Specification Summary**

Specification	Test Conditions	Min	Typ	Max	Unit
Input voltage	I <sub>out</sub> = 1000 mA	2.0	3.6	5.5	V
Output voltage	I <sub>out</sub> = 0 mA to 1000 mA	3.2	3.3	3.4	V
Output current	3.6 V in	0	1000	2500	mA
Operating frequency			2400		kHz
Efficiency	3.6 V in at 1000-mA load		90%		
Output ripple	3.6 V in at 500-mA load		25		mV

### 1.3 Modifications

The printed-circuit board (PCB) for this EVM is designed to accommodate both the fixed and adjustable versions of this integrated circuit (IC). If the fixed version is installed, R1 is replaced with a 0-Ω resistor and R2 is open. Extra positions are available for additional input and output capacitors.

#### 1.3.1 Adjustable Output IC U1 Operation

U1 is configured for evaluation of the adjustable output version. This unit is set to 3.3 V. Resistors R1 and R2 are used to set the output voltage between 1.2 V and 5.5 V. See the data sheet for recommended values.

#### 1.3.2 Fixed Output Operation

U1 can be replaced with the fixed version for evaluation. With the fixed version, R1 needs to be replaced with a 0-Ω resistor; R2 position is open.

## 2 Setup and Results

This section describes how to properly use the TPS63020EVM-487.

### 2.1 Input/Output Connector and Header Descriptions

#### 2.1.1 J1 – VIN

Positive input connection from the input supply for U1.

#### 2.1.2 J2 – Sense

V<sub>in</sub> Sense and GND Sense, low current sense lines for sampling input voltage at input capacitor.

#### 2.1.3 J3 – GND

V<sub>in</sub> GND return connection from the input supply for U1, common with J6.

#### 2.1.4 J4 – VOUT

Output voltage connection.

#### 2.1.5 J5 – Sense

V<sub>out</sub> Sense and GND Sense low current sense lines for sampling output voltage at output capacitor.

#### 2.1.6 J6 – GND

V<sub>out</sub> GND return connection for output voltage, common with J3.

#### 2.1.7 J7 – PG GND

Power Good (PG) test point and GND connection.

### 2.1.8 JP1 – ENABLE

Shorting jumper between the center pin and ON turns on the unit. Installing a shorting jumper between the center pin and OFF turns the unit off.

### 2.1.9 JP2 –PWR Save

Installing a shorting jumper between the center pin and OFF disables power-saving mode; jumper between center pin and ON enables power-saving mode. The center pin can be used to synchronize the unit with an external clock; see data sheet for additional details.

## 2.2 Setup

To operate the EVM, connect an input supply to the appropriate pins, and connect a load to the appropriate pins.

## 2.3 Power-Up

The soft-start circuit is controlled by a ramp to the current limit comparator that starts the switch current limit low and increases to maximum value. Output voltage is monitored during this time and must increase for switch current to increase.

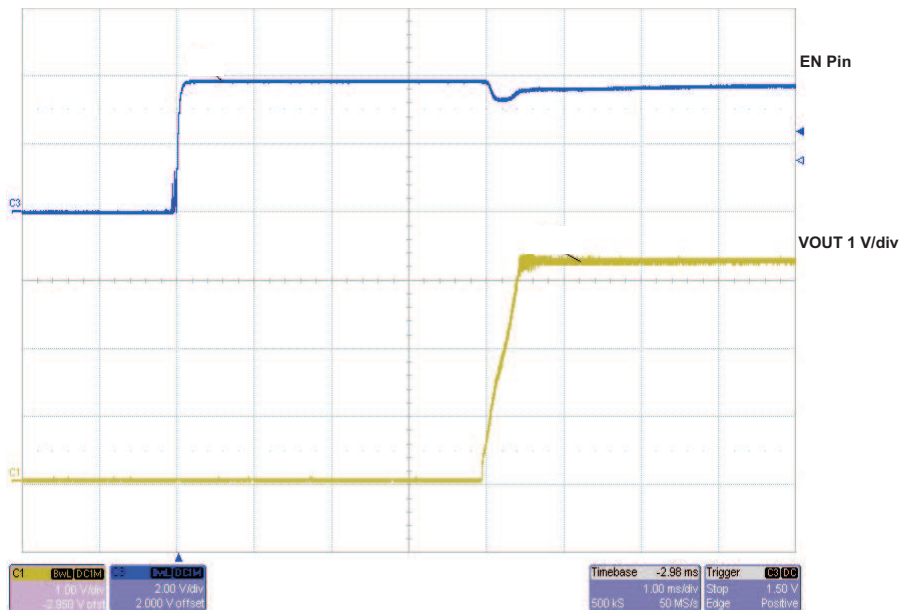

**Figure 1. Turn ON Into Electronic Load**

## 2.4 Output Ripple

Output ripple occurs at the switching frequency of 2.4 MHz, and with the recommended L and output C, is low. Amplitude of the ripple varies, depending on load current and input voltage. Ensure that the oscilloscope probe is connected as close as possible to the output capacitor, with a short ground lead, for accurate measurements. Resistance in trace and leads adds to output ripple, and ground lead length increases the amplitude of switching spikes.

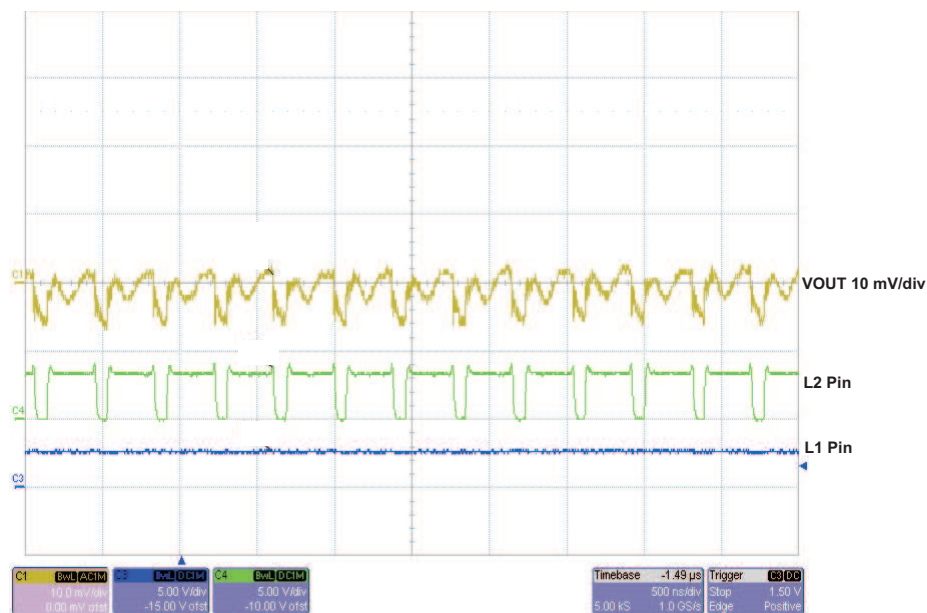
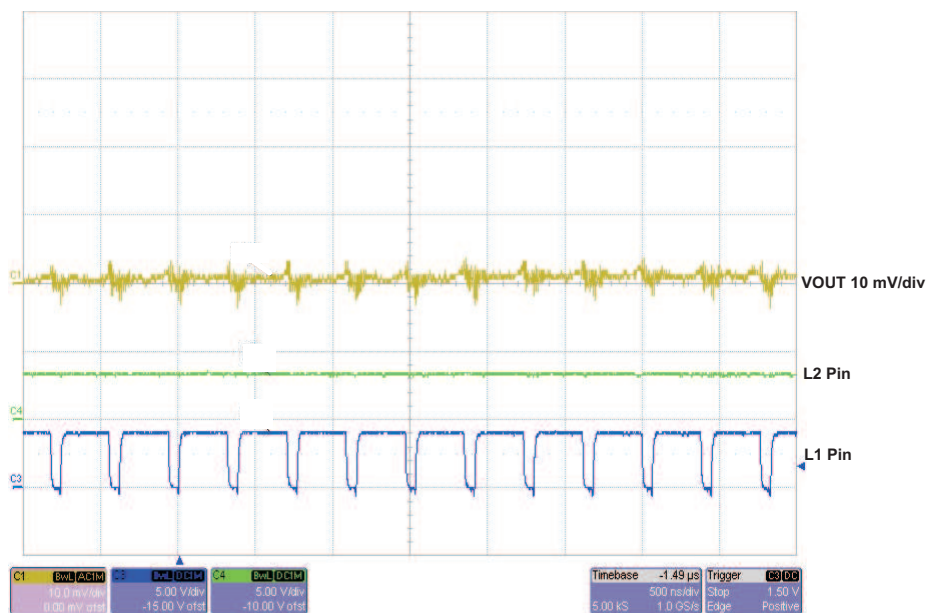
**Figure 2. Output Ripple Vin 3 V**

**Figure 3. Output Ripple Vin 4 V**

## 2.5 Efficiency

Efficiency of over 90% is common at mid-to-high loads. With power-save mode enabled, efficiency is greater than 80% at light loads of 1 mA to 100 mA.

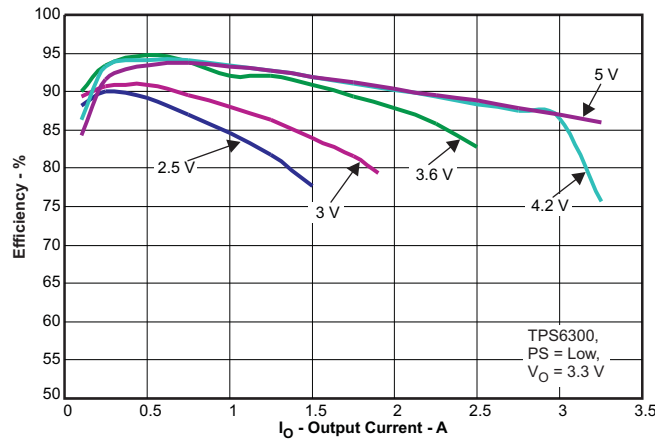

Figure 4. Efficiency Over Li-Ion Cell Range

## 2.6 Power Dissipation

With high efficiency, the power to be dissipated is low. Also, the QFN package with a solder pad is very efficient at removing heat. Care must be taken, however, to not overheat the device.

## 2.7 Load Transients

Load transient response is well regulated. Additional output capacitance reduces voltage overshoot and undershoot.

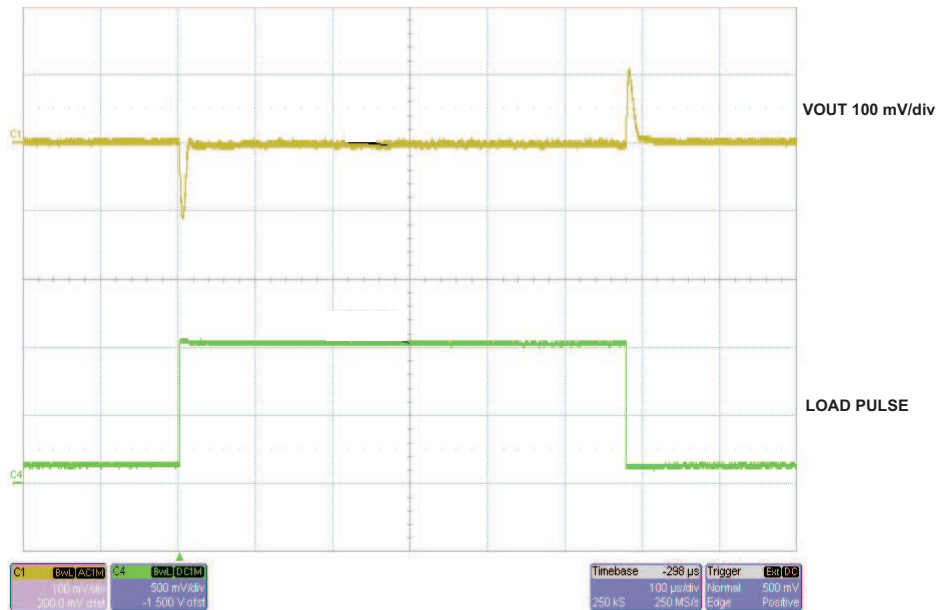

Figure 5. Load Step 100 mA to 500 mA

## 3 Board Layout

This section provides the TPS63020EVM-487 board layout and illustrations.

### 3.1 Layout

Figure 6 through Figure 8 show the board layout for the TPS63020EVM-487 PCB.

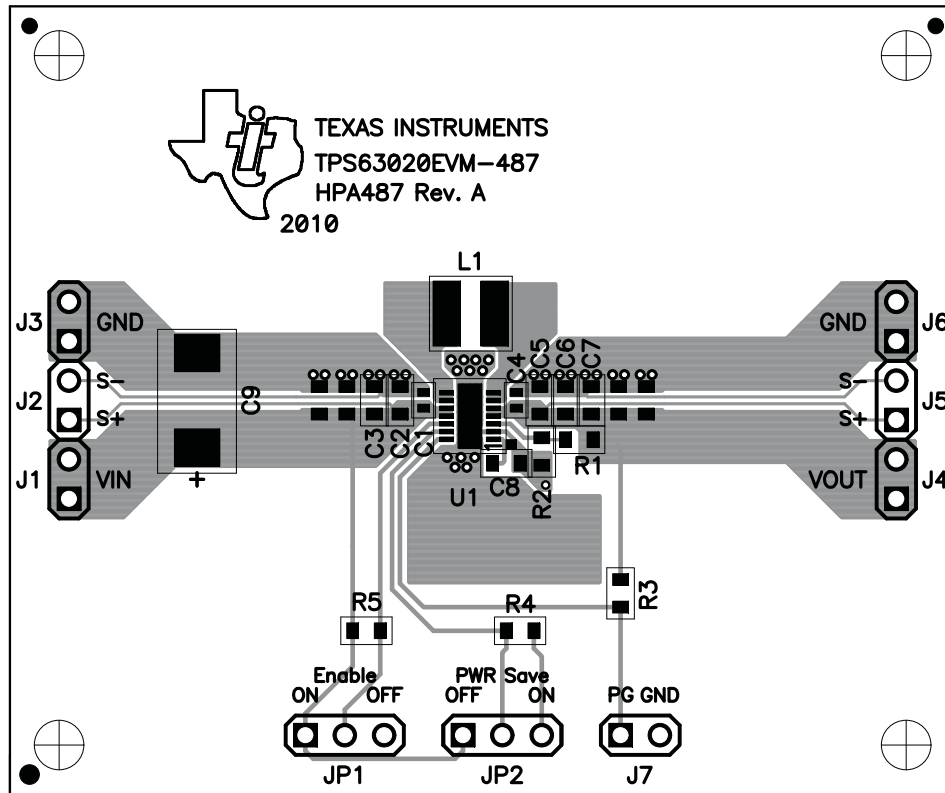

Figure 6. Assembly Layer

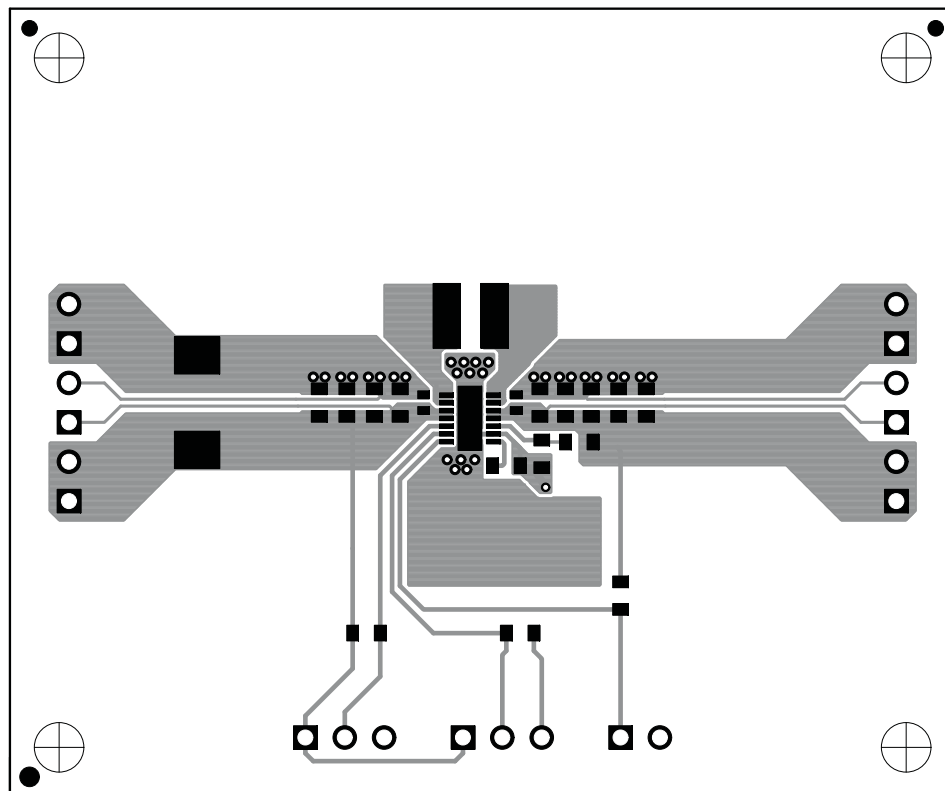

Figure 7. Top Layer Routing

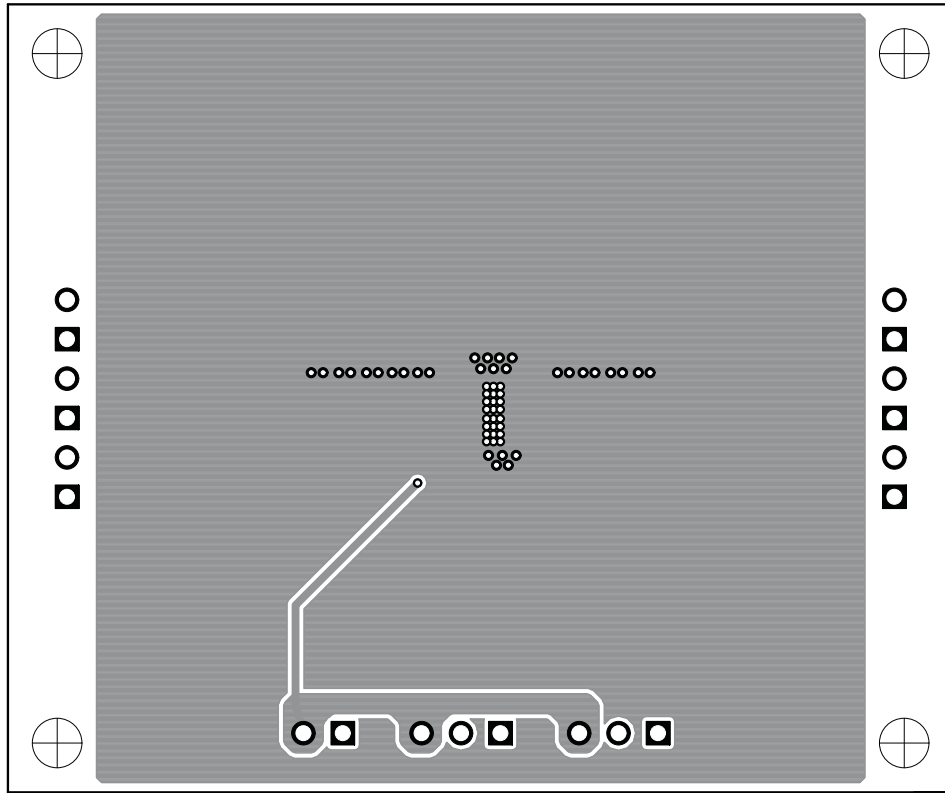

Figure 8. Bottom Layer Routing

## 4 Schematic and Bill of Materials

This section provides the TPS63020EVM-487 schematic and bill of materials.

### 4.1 Schematic

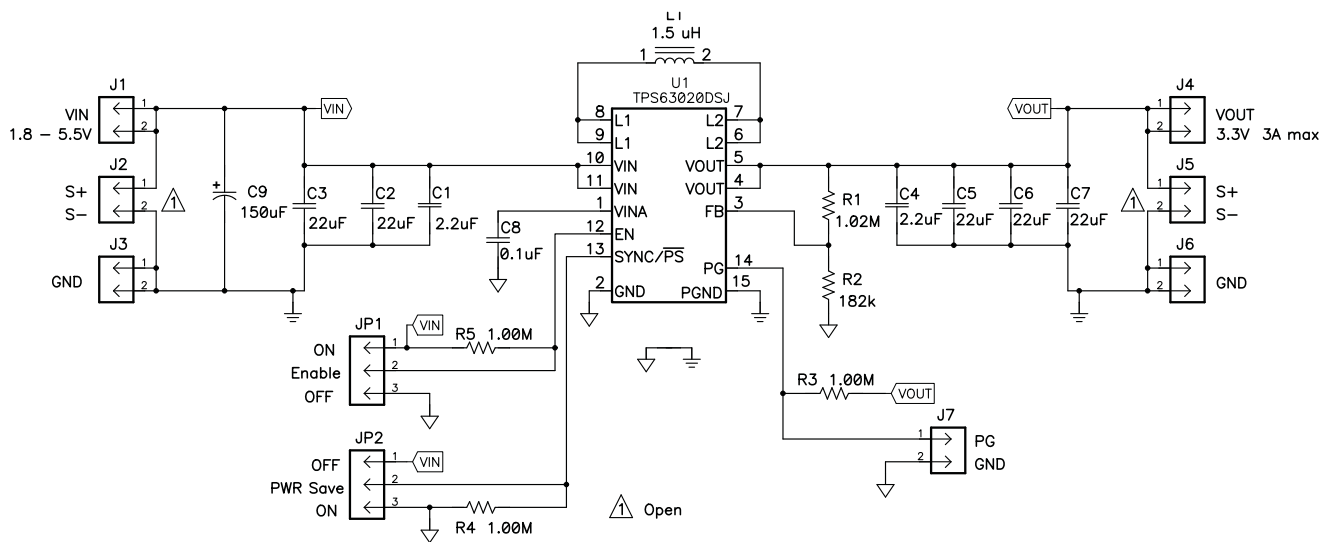

Figure 9. Schematic

## 4.2 Bill of Materials

**Table 2. TPS63020EVM-487 Bill of Materials**

Count	RefDes	Value	Description	Size	Part Number	MFR
2	C1, C4	2.2 $\mu$ F	Capacitor, ceramic, 6.3-V, X5R, 20%	0402	GRM155R60J225ME15D	Murata
5	C2, C3, C5, C6, C7	22 $\mu$ F	Capacitor, Ceramic, Low Inductance, 6.3V, X5R, 20%	0603	GRM188R60J226MEA0L	Murata
1	C8	0.1 $\mu$ F	Capacitor, Ceramic, Low Inductance, 25V, X7R, 10%	0603	Std	Std
1	C9	150 $\mu$ F	Capacitor, Tantalum, SMT, 150uF 10V, 100mOhm	D	B45197A2157K409	Kemet
1	L1	1.5 $\mu$ H	Inductor, Power, 4.1A, $\pm$ 20%	0.157 x 0.157 inch	XFL4020-152ME	Coilcraft
1	R1	1.02M	Resistor, chip, 1/16-W, 1%	0603	Std	Std
1	R2	182k	Resistor, Chip, 1/16W, 1%	0603	Std	Std
3	R3, R4, R5	1.00M	Resistor, Chip, 1/16W, 1%	0603	Std	Std
1	U1	—	IC, High Efficiency Single Inductor Buck-Boost Converter w/ 4-A Switches	SON-14	TPS63020DSJ	TI

### 4.3 Related Documentation From Texas Instruments

TPS63020, High-Current, Buck-Boost Converter data sheet ([SLVS916](#))

### 4.4 If You Need Assistance

Contact your local TI sales representative.



## FCC Warnings

This equipment is intended for use in a laboratory test environment only. It generates, uses, and can radiate radio frequency energy and has not been tested for compliance with the limits of computing devices pursuant to subpart J of part 15 of FCC rules, which are designed to provide reasonable protection against radio frequency interference. Operation of this equipment in other environments may cause interference with radio communications, in which case the user at his own expense will be required to take whatever measures may be required to correct this interference.

## EVM IMPORTANT NOTICE

Texas Instruments (TI) provides the enclosed product(s) under the following conditions:

This evaluation kit being sold by TI is intended for use for **ENGINEERING DEVELOPMENT OR EVALUATION PURPOSES ONLY** and is not considered by TI to be fit for commercial use. As such, the goods being provided may not be complete in terms of required design-, marketing-, and/or manufacturing-related protective considerations, including product safety measures typically found in the end product incorporating the goods. As a prototype, this product does not fall within the scope of the European Union directive on electromagnetic compatibility and therefore may not meet the technical requirements of the directive.

Should this evaluation kit not meet the specifications indicated in the EVM User's Guide, the kit may be returned within 30 days from the date of delivery for a full refund. **THE FOREGOING WARRANTY IS THE EXCLUSIVE WARRANTY MADE BY SELLER TO BUYER AND IS IN LIEU OF ALL OTHER WARRANTIES, EXPRESSED, IMPLIED, OR STATUTORY, INCLUDING ANY WARRANTY OF MERCHANTABILITY OR FITNESS FOR ANY PARTICULAR PURPOSE.**

The user assumes all responsibility and liability for proper and safe handling of the goods. Further, the user indemnifies TI from all claims arising from the handling or use of the goods. Please be aware that the products received may not be regulatory compliant or agency certified (FCC, UL, CE, etc.). Due to the open construction of the product, it is the user's responsibility to take any and all appropriate precautions with regard to electrostatic discharge.

**EXCEPT TO THE EXTENT OF THE INDEMNITY SET FORTH ABOVE, NEITHER PARTY SHALL BE LIABLE TO THE OTHER FOR ANY INDIRECT, SPECIAL, INCIDENTAL, OR CONSEQUENTIAL DAMAGES.**

TI currently deals with a variety of customers for products, and therefore our arrangement with the user **is not exclusive**.

TI assumes **no liability for applications assistance, customer product design, software performance, or infringement of patents or services described herein**.

Please read the EVM User's Guide and, specifically, the EVM Warnings and Restrictions notice in the EVM User's Guide prior to handling the product. This notice contains important safety information about temperatures and voltages. For further safety concerns, please contact the TI application engineer.

Persons handling the product must have electronics training and observe good laboratory practice standards.

No license is granted under any patent right or other intellectual property right of TI covering or relating to any machine, process, or combination in which such TI products or services might be or are used.

Mailing Address: Texas Instruments, Post Office Box 655303, Dallas, Texas 75265  
Copyright © 2010, Texas Instruments Incorporated

## EVM WARNINGS AND RESTRICTIONS

It is important to operate this EVM within the input voltage range of 3 V to 5.5 V. Maximum recommended output current is 1000 mA with 3.6-V input.

Exceeding the specified input range may cause unexpected operation and/or irreversible damage to the EVM. If there are questions concerning the input range, please contact a TI field representative prior to connecting the input power.

During normal operation, some circuit components may have case temperatures greater than 50°C. The EVM is designed to operate properly with certain components above 50°C as long as the input and output ranges are maintained. These components include but are not limited to linear regulators, switching transistors, pass transistors, and current sense resistors. These types of devices can be identified using the EVM schematic located in the EVM User's Guide. When placing measurement probes near these devices during operation, please be aware that these devices may be very warm to the touch.

Mailing Address: Texas Instruments, Post Office Box 655303, Dallas, Texas 75265  
Copyright © 2010, Texas Instruments Incorporated

## IMPORTANT NOTICE

Texas Instruments Incorporated and its subsidiaries (TI) reserve the right to make corrections, modifications, enhancements, improvements, and other changes to its products and services at any time and to discontinue any product or service without notice. Customers should obtain the latest relevant information before placing orders and should verify that such information is current and complete. All products are sold subject to TI's terms and conditions of sale supplied at the time of order acknowledgment.

TI warrants performance of its hardware products to the specifications applicable at the time of sale in accordance with TI's standard warranty. Testing and other quality control techniques are used to the extent TI deems necessary to support this warranty. Except where mandated by government requirements, testing of all parameters of each product is not necessarily performed.

TI assumes no liability for applications assistance or customer product design. Customers are responsible for their products and applications using TI components. To minimize the risks associated with customer products and applications, customers should provide adequate design and operating safeguards.

TI does not warrant or represent that any license, either express or implied, is granted under any TI patent right, copyright, mask work right, or other TI intellectual property right relating to any combination, machine, or process in which TI products or services are used. Information published by TI regarding third-party products or services does not constitute a license from TI to use such products or services or a warranty or endorsement thereof. Use of such information may require a license from a third party under the patents or other intellectual property of the third party, or a license from TI under the patents or other intellectual property of TI.

Reproduction of TI information in TI data books or data sheets is permissible only if reproduction is without alteration and is accompanied by all associated warranties, conditions, limitations, and notices. Reproduction of this information with alteration is an unfair and deceptive business practice. TI is not responsible or liable for such altered documentation. Information of third parties may be subject to additional restrictions.

Resale of TI products or services with statements different from or beyond the parameters stated by TI for that product or service voids all express and any implied warranties for the associated TI product or service and is an unfair and deceptive business practice. TI is not responsible or liable for any such statements.

TI products are not authorized for use in safety-critical applications (such as life support) where a failure of the TI product would reasonably be expected to cause severe personal injury or death, unless officers of the parties have executed an agreement specifically governing such use. Buyers represent that they have all necessary expertise in the safety and regulatory ramifications of their applications, and acknowledge and agree that they are solely responsible for all legal, regulatory and safety-related requirements concerning their products and any use of TI products in such safety-critical applications, notwithstanding any applications-related information or support that may be provided by TI. Further, Buyers must fully indemnify TI and its representatives against any damages arising out of the use of TI products in such safety-critical applications.

TI products are neither designed nor intended for use in military/aerospace applications or environments unless the TI products are specifically designated by TI as military-grade or "enhanced plastic." Only products designated by TI as military-grade meet military specifications. Buyers acknowledge and agree that any such use of TI products which TI has not designated as military-grade is solely at the Buyer's risk, and that they are solely responsible for compliance with all legal and regulatory requirements in connection with such use.

TI products are neither designed nor intended for use in automotive applications or environments unless the specific TI products are designated by TI as compliant with ISO/TS 16949 requirements. Buyers acknowledge and agree that, if they use any non-designated products in automotive applications, TI will not be responsible for any failure to meet such requirements.

Following are URLs where you can obtain information on other Texas Instruments products and application solutions:

<b>Products</b>		<b>Applications</b>	
Amplifiers	<a href="http://amplifier.ti.com">amplifier.ti.com</a>	Audio	<a href="http://www.ti.com/audio">www.ti.com/audio</a>
Data Converters	<a href="http://dataconverter.ti.com">dataconverter.ti.com</a>	Automotive	<a href="http://www.ti.com/automotive">www.ti.com/automotive</a>
DLP® Products	<a href="http://www.dlp.com">www.dlp.com</a>	Communications and Telecom	<a href="http://www.ti.com/communications">www.ti.com/communications</a>
DSP	<a href="http://dsp.ti.com">dsp.ti.com</a>	Computers and Peripherals	<a href="http://www.ti.com/computers">www.ti.com/computers</a>
Clocks and Timers	<a href="http://www.ti.com/clocks">www.ti.com/clocks</a>	Consumer Electronics	<a href="http://www.ti.com/consumer-apps">www.ti.com/consumer-apps</a>
Interface	<a href="http://interface.ti.com">interface.ti.com</a>	Energy	<a href="http://www.ti.com/energy">www.ti.com/energy</a>
Logic	<a href="http://logic.ti.com">logic.ti.com</a>	Industrial	<a href="http://www.ti.com/industrial">www.ti.com/industrial</a>
Power Mgmt	<a href="http://power.ti.com">power.ti.com</a>	Medical	<a href="http://www.ti.com/medical">www.ti.com/medical</a>
Microcontrollers	<a href="http://microcontroller.ti.com">microcontroller.ti.com</a>	Security	<a href="http://www.ti.com/security">www.ti.com/security</a>
RFID	<a href="http://www.ti-rfid.com">www.ti-rfid.com</a>	Space, Avionics & Defense	<a href="http://www.ti.com/space-avionics-defense">www.ti.com/space-avionics-defense</a>
RF/IF and ZigBee® Solutions	<a href="http://www.ti.com/lprf">www.ti.com/lprf</a>	Video and Imaging	<a href="http://www.ti.com/video">www.ti.com/video</a>
		Wireless	<a href="http://www.ti.com/wireless-apps">www.ti.com/wireless-apps</a>