

TPS740xxDPTEVM-713 Evaluation Module

This user's guide describes the characteristics, operation, and use of the TPS74001DPTEVM-713 and TPS74012DPTEVM-713 evaluation modules (EVM). The TPS740xxDPTEVM-713 is a fully assembled and tested platform for evaluating the performance of the TPS740xx low-dropout voltage regulator in a Jr S-Pak™ package. The TPS740xx family is a set of wide bandwidth, very low-dropout, 1.5A voltage regulators, ideal for powering microprocessors, with adjustable output voltages between 0.9V and 4.0V. TPS74001DPTEVM-713 EVM has an output voltage of 1.5V, set by external resistors, while the TPS74012DPTEVM-713 has an output voltage of 1.2V, set by internal resistors and cannot be changed. This user's guide includes setup configuration instructions, a complete schematic diagram, bill of materials (BOM), and printed circuit board (PCB) layout drawings for the evaluation module.

Contents

1	Introduction	2
	1.1 Features	2
	1.2 Orderable Options	2
2	Schematic	3
3	Setup and Board Description	3
	3.1 EVM Input/Output Connectors and Test Jumpers	3
	3.2 Connection Setup	4
4	Operation	4
	4.1 Adjustable Output Voltage	4
	4.2 Transient Response	5
	4.3 Dropout Voltage, V_{DO}	5
	4.4 Enable / Shutdown (Fixed Voltage Version Only – TPS74012DPT)	6
	4.5 Internal Current Limit	6
	4.6 Thermal Protection	6
5	Board Layout	7
6	Bill of Materials	9

List of Figures

1	TPS74001DPTEVM-713 Rev A Schematic	3
2	Quick Start Connection Setup	4
3	Transient Response of TPS74001DPTEVM-713 with $V_{IN} = 3.5V$, $V_{BIAS} = 5.0V$, Load = 1.2A	5
4	Dropout Voltage, V_{DO} , measurement of TPS74001DPTEVM-713 for $V_{BIAS} = 5.0V$, $V_{OUT} = 1.5V$	6
5	Silkscreen Layer	7
6	Assembly Layer	7
7	Top Layer Routing	8
8	Bottom Layer Routing	8

List of Tables

1	List of Input and Output Connectors	3
2	Sample Resistor Values for Common Output Voltages for TPS74001DPT EVM	5
3	Bill of Materials	9
4	Assembly Number and Corresponding Label Text	9

1 Introduction

The TPS740xxDPTEVM-713 helps designers evaluate the operation and performance of the TPS740xx low voltage, low-dropout regulator in a 5-pin Jr S-Pak™ package. This particular EVM configuration contains a low voltage, low-dropout 1.5A voltage regulator (LDO) with dual input voltages with input voltage range of 1.2V to 5.5V and input V_{BIAS} range of 3.0V to 5.5V. There are two TPS740xxDPT EVMs available: one with an adjustable output voltage and one with a fixed voltage of 1.2V. The output voltage of TPS74001DPT EVM is adjustable and is configured with external resistors, R1 and R2, to 1.5V. The output voltage for this part can be adjusted to be between 0.9V and 4.0V. The output voltage of TPS74012DPT EVM is fixed to 1.2V, set by resistors internal to the IC, and cannot be modified. The TPS740xx is also available in an 8-pin POWER MSOP-8 package, which has its own orderable evaluation module, TPS74001DGKEVM-722 (adjustable output voltage) or TPS74012DKGEVM-722 (fixed output voltage of 1.2V). The TPS740xx is ideal for powering microprocessors.

1.1 Features

- Small consumption current: 3mA maximum
- Input voltage ranges:
 - V_{IN} : 1.2 V to 5.5 V
 - V_{BIAS} : 3.0 V to 5.5 V
- Stable with any output capacitor $\geq 2.2\mu\text{F}$
- $\pm 1\%$ initial tolerance
- Maximum dropout voltage ($V_{IN}-V_{OUT}$) of 300 mV over temperature
- Ultra fast transient response
- Excellent line and load regulation
- Thermal shutdown and current limit protection
- Logic controlled shutdown option
- Junction temperature range of -40°C to 125°C

1.2 Orderable Options

- TPS74001DPTEVM-713: EVM output voltage configured to 1.5 V by external resistors, and is adjustable to between 0.9 V and 4.0 V
- TPS74012DPTEVM-713: fixed EVM output voltage of 1.2 V, set by resistors internal to the IC

2 Schematic

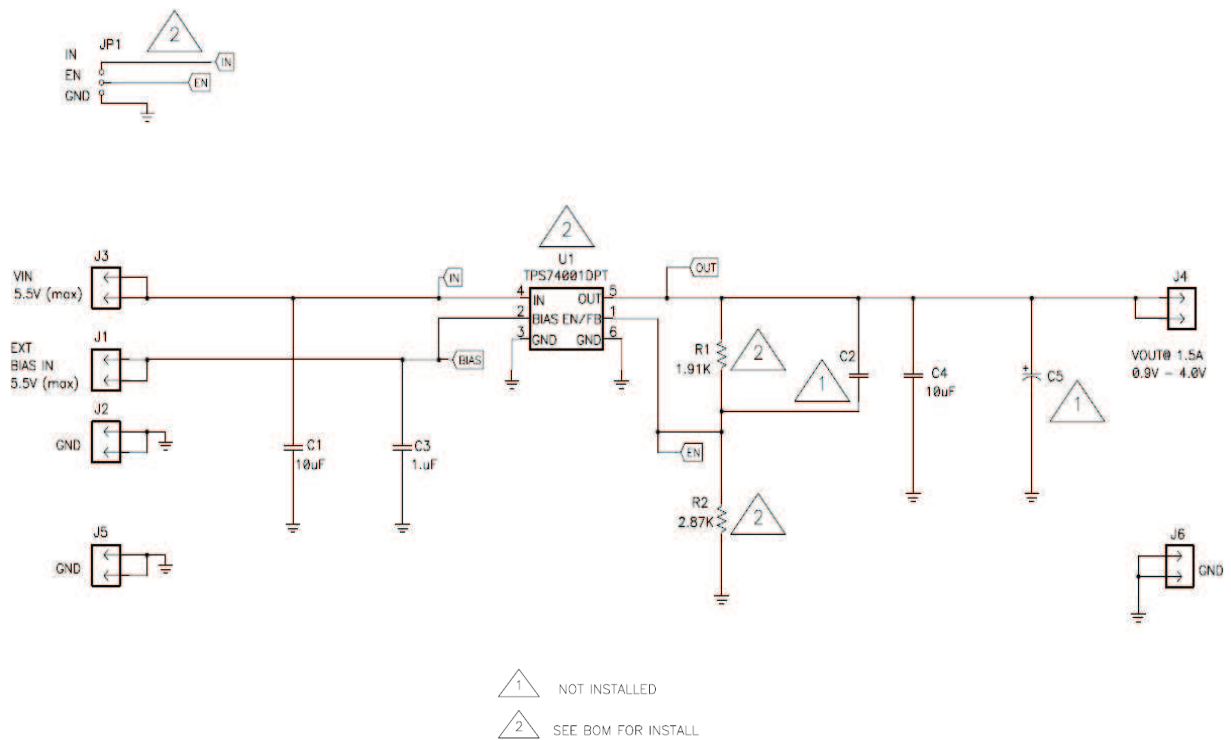

Figure 1. TPS74001DPTEVM-713 Rev A Schematic

3 Setup and Board Description

3.1 EVM Input/Output Connectors and Test Jumpers

Table 1. List of Input and Output Connectors

Connector	Label	Description
J1	BIAS	V_{BIAS} input power supply connection: 3.0V to 5.5V. Used to power error amplifier, reference, and internal control circuits.
J2	GND	Return connection for V_{BIAS} input power supply.
J3	VIN	V_{IN} input power supply connection: 1.2V to 5.5V. Note: $V_{IN} \geq V_{OUT} + V_{DO}$ for proper operation
J4	VOUT	Regulated output voltage connection.
J5	GND	Return connection for V_{IN} input power supply.
J6	GND	Return connection for V_{OUT} .
JP1	IN/EN/GND	Ties EN pin to either V_{IN} (high) or GND (low). Used for TPS74001DPT only. Not used for TPS74001DPT. Driving this pin high enables the regulator. Driving this pin low puts the regulator into shutdown mode. This pin must not be left unconnected.

3.2 Connection Setup

1. Connect power supply #1 to V_{IN} (J3) and its return connection to J5 as shown in Figure 2. V_{IN} should be at least 300mV (or V_{DO}) greater than V_{OUT} , up to 5.5V.
2. Connect power supply #2 to V_{BIAS} (J1) and its return connection to J2 as shown in Figure 2. V_{BIAS} must be between 3.0V and 5.5V.
3. An ammeter can be connected in series with either power supply to measure the supply current or bias current.
4. For TPS74012DPT (fixed voltage part), attach a jumper on JP1 shorting EN and V_{IN} (ties EN high).
5. If desired, a load can be connected at the output, J4 and J6.
6. Connect a voltmeter or an oscilloscope voltage probe across the output pins J4 and J6 to observe and measure the regulated output voltage.

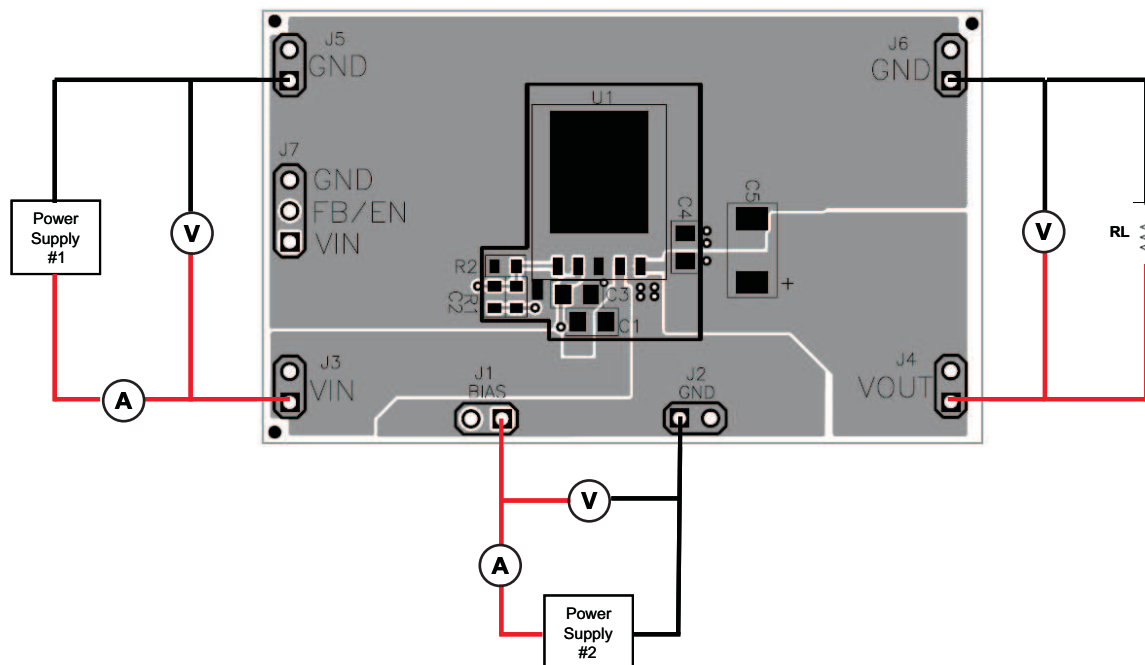

Figure 2. Quick Start Connection Setup

4 Operation

This section provides information about the operation of the TPS740xxDPTEVM and expected outputs. The TPS740xx parts can support input voltages (V_{IN}) between 1.2V and 5.5V and output voltages (V_{OUT}) between 0.9V and 4.0V. A separate V_{BIAS} input supply (3.0V to 5.5V) powers the error amplifier, reference, and internal control circuits to allow for very low main input supply voltage. The TPS740xx requires only a small output ceramic capacitor of 2.2 μ F (minimum) to ensure stability of the IC.

4.1 Adjustable Output Voltage

TPS74001DPT EVM comes configured for a 1.5V output voltage. However, this output voltage can easily be modified to range between 0.9V and 4.0V by changing the values of the resistors R_1 and R_2 that form a voltage divider at the output of the IC. In order to achieve maximum accuracy, R_2 is recommended to be lower than 4.99k Ω . Proper values for R_1 and R_2 for a desired V_{OUT} can be calculated using:

$$V_{OUT} = 0.9 \times \left(1 + \frac{R_1}{R_2} \right) \quad (1)$$

Sample resistor values of common output voltages are shown in Table 2.

Table 2. Sample Resistor Values for Common Output Voltages for TPS74001DPT EVM

R ₁ [kΩ]	R ₂ [kΩ]	V _{OUT} [V]
Short	Open	0.9
0.562	5.11	1.0
0.75	4.53	1.05
1.07	4.99	1.1
1.58	4.75	1.2
1.91	2.87	1.5
2.43	2.43	1.8
3.01	1.69	2.5
4.22	1.58	3.3
5.23	1.74	3.6

TPS74012DPTEVM is a fixed output voltage IC and cannot be modified. The output voltage is fixed at 1.2V.

4.2 Transient Response

The TPS740xx is designed to have excellent transient response for most applications with a small amount of output capacitance. The TPS740xx is stable with a ceramic output capacitor as low as 2.2μF. Additional output capacitance will serve to reduce undershoot and overshoot at the output during a transient event.

Below is an example load transient response captured with V_{IN} = 3.5V, V_{BIAS} = 5.0V, Load = 1.2A.

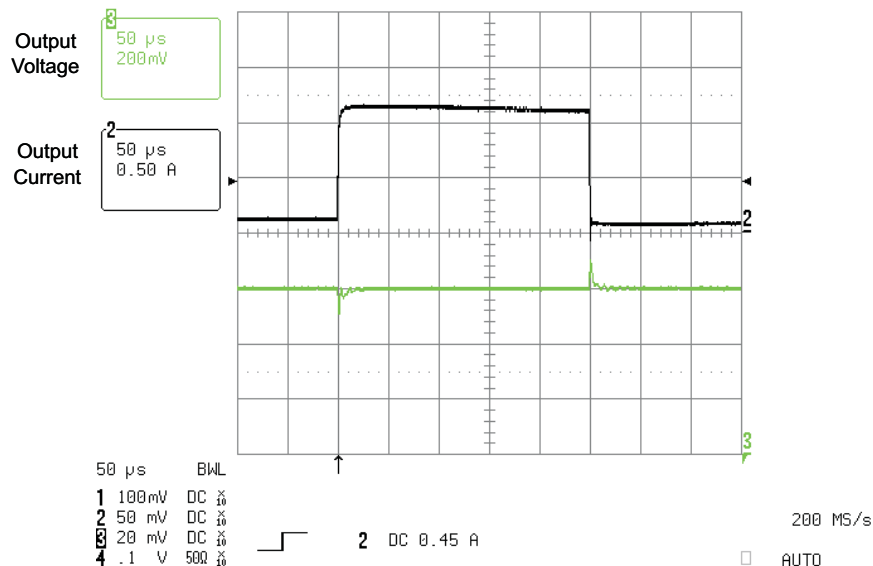

Figure 3. Transient Response of TPS74001DPT EVM-713 with V_{IN} = 3.5V, V_{BIAS} = 5.0V, Load = 1.2A

4.3 Dropout Voltage, V_{DO}

TPS740xxDPT offers very low dropout performance and allows the device to be used in place of a DC/DC converter and still achieve good efficiency. The V_{IN} dropout voltage, V_{IN}-V_{OUT}, for the TPS740xxDPT is specified to be a maximum of 300mV at 1.5A load for V_{BIAS} = V_{OUT} + 2.0V. The V_{IN} dropout voltage decreases as V_{BIAS} increases.

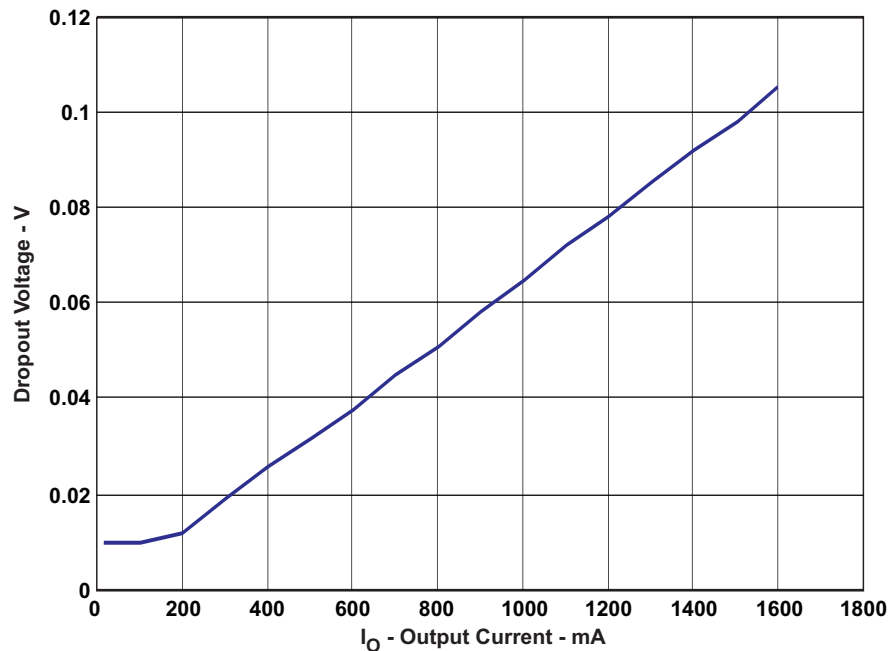

Figure 4. Dropout Voltage, V_{DO} , measurement of TPS74001DPTEVM-713 for $V_{BIAS} = 5.0V$, $V_{OUT} = 1.5V$

4.4 Enable / Shutdown (Fixed Voltage Version Only – TPS74012DPT)

The EN pin is active high and enables the regulator. When V_{EN} is above 1.1V, the regulator turns on. When V_{EN} is below 0.4V, the regulator turns off. The enable circuitry has hysteresis and deglitching to help avoid on/off cycling as a result of small glitches in the V_{EN} signal. V_{EN} threshold is typically 0.8V but varies slightly with temperature and process variations. See the TPS740xx datasheet for more information.

4.5 Internal Current Limit

TPS740xxDPT features an internal current limit protection circuitry that is designed to protect against overload conditions. The current limit responds in approximately 10 μ s to reduce the current during a short-circuit fault. The current limit circuitry will allow up to a maximum of 4.0A before clamping the output current. The resulting V_{OUT} will be 80% of V_{OUT} nominal. See the TPS740xx datasheet for more information.

4.6 Thermal Protection

TPS740xxDPT comes with a thermal protection circuit that disables the output of the IC when the junction temperature rises to approximately 160°C. When the junction temperature cools down to approximately 140°C, the output circuitry is once again enabled. The thermal protection circuit may cycle on and off depending on the power dissipation, thermal resistance, and ambient temperature of the EVM. See the TPS740xx datasheet for more information.

5 Board Layout

This section provides the TPS740xxDPTEVM-713 board layout and illustrations.

NOTE: Board layouts are not to scale. These figures are intended to show how the board is laid out; they are not intended to be used for manufacturing TPS740xxDPTEVM-713 PCBs.

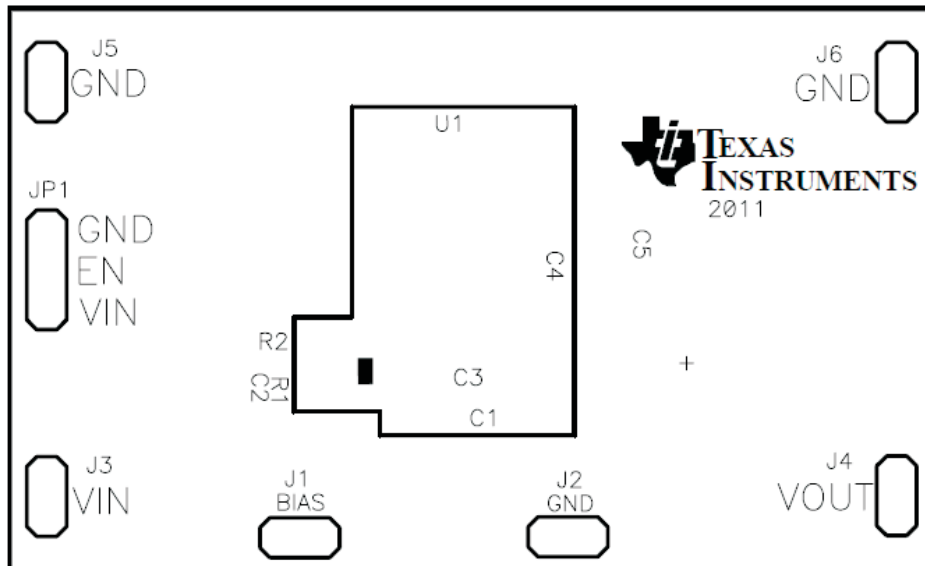

Figure 5. Silkscreen Layer

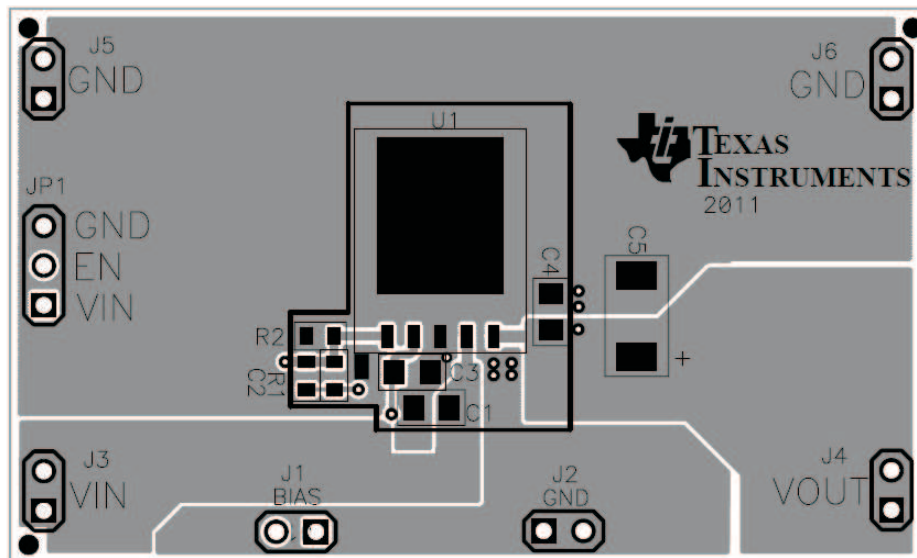

Figure 6. Assembly Layer

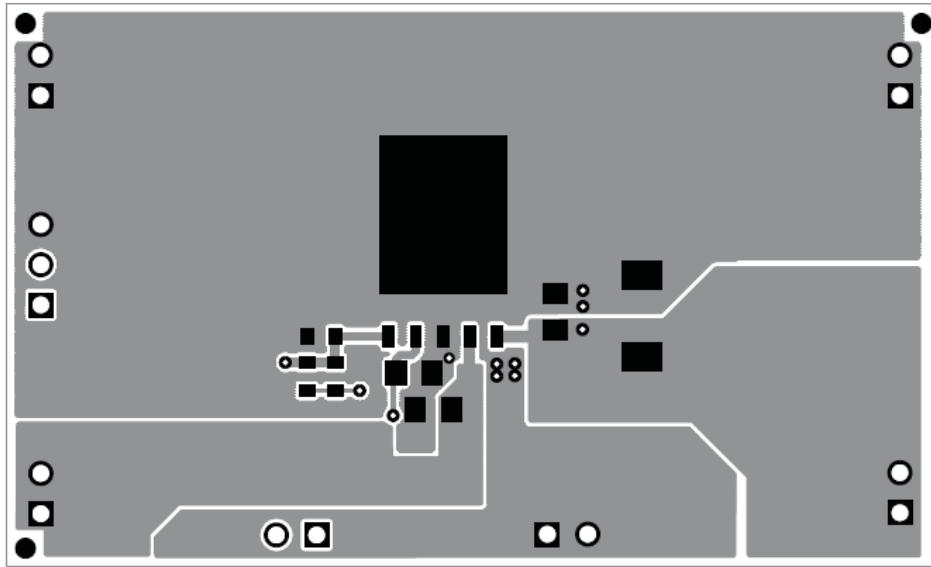

Figure 7. Top Layer Routing

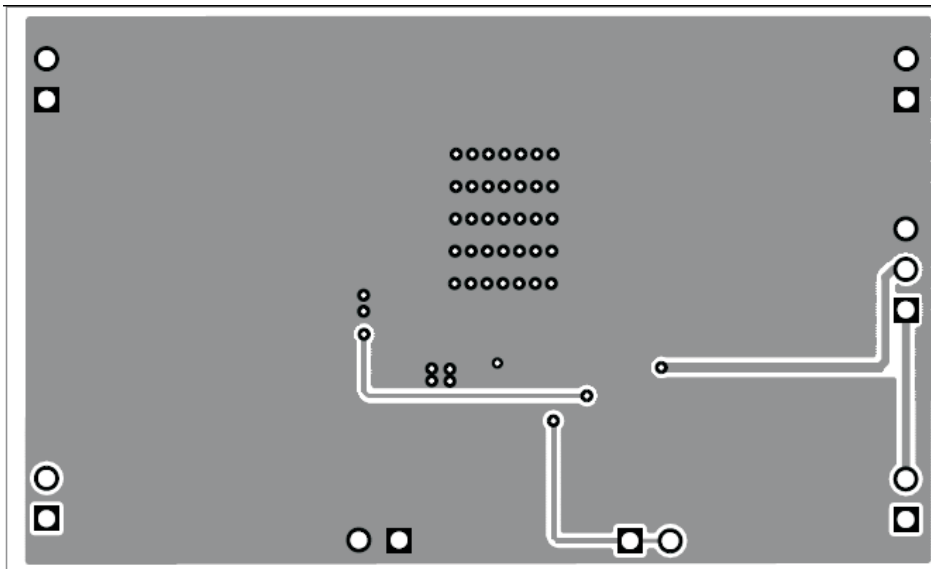

Figure 8. Bottom Layer Routing

6 Bill of Materials

Table 3. Bill of Materials

HPA713-001	HPA713-002						
Count	Count	RefDes	Value	Description	Size	Part Number	MFR
2	2	C1, C4	10 μ F	Capacitor, Ceramic, 10V, X5R 20%	0805	STD	STD
0	0	C2	DNI	Capacitor, Ceramic	0603	STD	STD
1	1	C3	1 μ F	Capacitor, Ceramic, 6.3V, X5R, 10%	0805	STD	STD
0	0	C5	DNI	Capacitor, Ceramic	6032	STD	STD
6	6	J1, J2, J3, J4, J5, J6	PEC02SAAN	Header, Male 2-pin, 100mil spacing	0.100 inch x 2	PEC02SAAN	Sullins
0	1	JP1	PEC03SAAN	Header, Male 3-pin, 100mil spacing	0.100 inch x 3	PEC03SAAN	Sullins
1	0	R1	1.91K	Resistor, Chip, 1/16W, 1%	0603	STD	STD
1	0	R2	2.87K	Resistor, Chip, 1/16W, 1%	0603	STD	STD
1	0	U1	TPS74001DPT	IC, 1.5A Low Voltage LDO Regulator with Dual Input Voltages	PVSON	TPS74001DPT	TI
0	1	U1	TPS74012DPT	IC, 1.5A Low Voltage LDO Regulator with Dual Input Voltages	PVSON	TPS74012DPT	TI

Notes: 1. These assemblies are ESD sensitive, ESD precautions shall be observed.
 2. These assemblies must be clean and free from flux and all contaminants. Use of no clean flux is not acceptable.
 3. These assemblies must comply with workmanship standards IPC-A-610 Class 2.
 4. Ref designators marked with an asterisk (***) cannot be substituted. All other components can be substituted with equivalent MFG's components.
 5. Install label after final wash. Text shall be 8 pt font. Text shall be per [Table 4](#).

Table 4. Assembly Number and Corresponding Label Text

ASSEMBLY NUMBER	TEXT
HPA713-001	TPS74001DPTEVM-713
HPA713-002	TPS74012DPTEVM-713

Evaluation Board/Kit Important Notice

Texas Instruments (TI) provides the enclosed product(s) under the following conditions:

This evaluation board/kit is intended for use for **ENGINEERING DEVELOPMENT, DEMONSTRATION, OR EVALUATION PURPOSES ONLY** and is not considered by TI to be a finished end-product fit for general consumer use. Persons handling the product(s) must have electronics training and observe good engineering practice standards. As such, the goods being provided are not intended to be complete in terms of required design-, marketing-, and/or manufacturing-related protective considerations, including product safety and environmental measures typically found in end products that incorporate such semiconductor components or circuit boards. This evaluation board/kit does not fall within the scope of the European Union directives regarding electromagnetic compatibility, restricted substances (RoHS), recycling (WEEE), FCC, CE or UL, and therefore may not meet the technical requirements of these directives or other related directives.

Should this evaluation board/kit not meet the specifications indicated in the User's Guide, the board/kit may be returned within 30 days from the date of delivery for a full refund. **THE FOREGOING WARRANTY IS THE EXCLUSIVE WARRANTY MADE BY SELLER TO BUYER AND IS IN LIEU OF ALL OTHER WARRANTIES, EXPRESSED, IMPLIED, OR STATUTORY, INCLUDING ANY WARRANTY OF MERCHANTABILITY OR FITNESS FOR ANY PARTICULAR PURPOSE.**

The user assumes all responsibility and liability for proper and safe handling of the goods. Further, the user indemnifies TI from all claims arising from the handling or use of the goods. Due to the open construction of the product, it is the user's responsibility to take any and all appropriate precautions with regard to electrostatic discharge.

EXCEPT TO THE EXTENT OF THE INDEMNITY SET FORTH ABOVE, NEITHER PARTY SHALL BE LIABLE TO THE OTHER FOR ANY INDIRECT, SPECIAL, INCIDENTAL, OR CONSEQUENTIAL DAMAGES.

TI currently deals with a variety of customers for products, and therefore our arrangement with the user **is not exclusive.**

TI assumes **no liability for applications assistance, customer product design, software performance, or infringement of patents or services described herein.**

Please read the User's Guide and, specifically, the Warnings and Restrictions notice in the User's Guide prior to handling the product. This notice contains important safety information about temperatures and voltages. For additional information on TI's environmental and/or safety programs, please contact the TI application engineer or visit www.ti.com/esh.

No license is granted under any patent right or other intellectual property right of TI covering or relating to any machine, process, or combination in which such TI products or services might be or are used.

FCC Warning

This evaluation board/kit is intended for use for **ENGINEERING DEVELOPMENT, DEMONSTRATION, OR EVALUATION PURPOSES ONLY** and is not considered by TI to be a finished end-product fit for general consumer use. It generates, uses, and can radiate radio frequency energy and has not been tested for compliance with the limits of computing devices pursuant to part 15 of FCC rules, which are designed to provide reasonable protection against radio frequency interference. Operation of this equipment in other environments may cause interference with radio communications, in which case the user at his own expense will be required to take whatever measures may be required to correct this interference.

EVM Warnings and Restrictions

It is important to operate this EVM within the input voltage range of 1.2 V to 5.5 V and the output voltage range of 0.9 V to 4.0 V . Exceeding the specified input range may cause unexpected operation and/or irreversible damage to the EVM. If there are questions concerning the input range, please contact a TI field representative prior to connecting the input power.

Applying loads outside of the specified output range may result in unintended operation and/or possible permanent damage to the EVM. Please consult the EVM User's Guide prior to connecting any load to the EVM output. If there is uncertainty as to the load specification, please contact a TI field representative.

During normal operation, some circuit components may have case temperatures greater than 85° C. The EVM is designed to operate properly with certain components above 85° C as long as the input and output ranges are maintained. These components include but are not limited to linear regulators, switching transistors, pass transistors, and current sense resistors. These types of devices can be identified using the EVM schematic located in the EVM User's Guide. When placing measurement probes near these devices during operation, please be aware that these devices may be very warm to the touch.

Mailing Address: Texas Instruments, Post Office Box 655303, Dallas, Texas 75265
Copyright © 2011, Texas Instruments Incorporated

IMPORTANT NOTICE

Texas Instruments Incorporated and its subsidiaries (TI) reserve the right to make corrections, modifications, enhancements, improvements, and other changes to its products and services at any time and to discontinue any product or service without notice. Customers should obtain the latest relevant information before placing orders and should verify that such information is current and complete. All products are sold subject to TI's terms and conditions of sale supplied at the time of order acknowledgment.

TI warrants performance of its hardware products to the specifications applicable at the time of sale in accordance with TI's standard warranty. Testing and other quality control techniques are used to the extent TI deems necessary to support this warranty. Except where mandated by government requirements, testing of all parameters of each product is not necessarily performed.

TI assumes no liability for applications assistance or customer product design. Customers are responsible for their products and applications using TI components. To minimize the risks associated with customer products and applications, customers should provide adequate design and operating safeguards.

TI does not warrant or represent that any license, either express or implied, is granted under any TI patent right, copyright, mask work right, or other TI intellectual property right relating to any combination, machine, or process in which TI products or services are used. Information published by TI regarding third-party products or services does not constitute a license from TI to use such products or services or a warranty or endorsement thereof. Use of such information may require a license from a third party under the patents or other intellectual property of the third party, or a license from TI under the patents or other intellectual property of TI.

Reproduction of TI information in TI data books or data sheets is permissible only if reproduction is without alteration and is accompanied by all associated warranties, conditions, limitations, and notices. Reproduction of this information with alteration is an unfair and deceptive business practice. TI is not responsible or liable for such altered documentation. Information of third parties may be subject to additional restrictions.

Resale of TI products or services with statements different from or beyond the parameters stated by TI for that product or service voids all express and any implied warranties for the associated TI product or service and is an unfair and deceptive business practice. TI is not responsible or liable for any such statements.

TI products are not authorized for use in safety-critical applications (such as life support) where a failure of the TI product would reasonably be expected to cause severe personal injury or death, unless officers of the parties have executed an agreement specifically governing such use. Buyers represent that they have all necessary expertise in the safety and regulatory ramifications of their applications, and acknowledge and agree that they are solely responsible for all legal, regulatory and safety-related requirements concerning their products and any use of TI products in such safety-critical applications, notwithstanding any applications-related information or support that may be provided by TI. Further, Buyers must fully indemnify TI and its representatives against any damages arising out of the use of TI products in such safety-critical applications.

TI products are neither designed nor intended for use in military/aerospace applications or environments unless the TI products are specifically designated by TI as military-grade or "enhanced plastic." Only products designated by TI as military-grade meet military specifications. Buyers acknowledge and agree that any such use of TI products which TI has not designated as military-grade is solely at the Buyer's risk, and that they are solely responsible for compliance with all legal and regulatory requirements in connection with such use.

TI products are neither designed nor intended for use in automotive applications or environments unless the specific TI products are designated by TI as compliant with ISO/TS 16949 requirements. Buyers acknowledge and agree that, if they use any non-designated products in automotive applications, TI will not be responsible for any failure to meet such requirements.

Following are URLs where you can obtain information on other Texas Instruments products and application solutions:

Products

Audio	www.ti.com/audio
Amplifiers	amplifier.ti.com
Data Converters	dataconverter.ti.com
DLP® Products	www.dlp.com
DSP	dsp.ti.com
Clocks and Timers	www.ti.com/clocks
Interface	interface.ti.com
Logic	logic.ti.com
Power Mgmt	power.ti.com
Microcontrollers	microcontroller.ti.com
RFID	www.ti-rfid.com
RF/IF and ZigBee® Solutions	www.ti.com/lprf

Applications

Communications and Telecom	www.ti.com/communications
Computers and Peripherals	www.ti.com/computers
Consumer Electronics	www.ti.com/consumer-apps
Energy and Lighting	www.ti.com/energy
Industrial	www.ti.com/industrial
Medical	www.ti.com/medical
Security	www.ti.com/security
Space, Avionics and Defense	www.ti.com/space-avionics-defense
Transportation and Automotive	www.ti.com/automotive
Video and Imaging	www.ti.com/video
Wireless	www.ti.com/wireless-apps

TI E2E Community Home Page

e2e.ti.com

Mailing Address: Texas Instruments, Post Office Box 655303, Dallas, Texas 75265
Copyright © 2011, Texas Instruments Incorporated