

# TPS562209 Step-Down Converter Evaluation Module User's Guide



## ABSTRACT

This user's guide contains information for the TPS562209 as well as support documentation for the TPS562209EVM-601 evaluation module. Included are the performance specifications, schematic, and the bill of materials of the TPS562209EVM-601.

## Table of Contents

<b>1 Introduction</b> .....	3
<b>2 Performance Specification Summary</b> .....	4
<b>3 Modifications</b> .....	4
3.1 Output Voltage Setpoint.....	4
<b>4 Test Setup and Results</b> .....	5
4.1 Input/Output Connections.....	5
4.2 Start-Up Procedure.....	5
4.3 Efficiency.....	6
4.4 Load Regulation.....	7
4.5 Line Regulation.....	7
4.6 Load Transient Response.....	8
4.7 Output Voltage Ripple.....	9
4.8 Input Voltage Ripple.....	9
4.9 Start-Up.....	10
4.10 Shut-Down.....	11
<b>5 Board Layout</b> .....	12
5.1 Layout.....	12
<b>6 Schematic, Bill of Materials, and Reference</b> .....	14
6.1 Schematic.....	14
6.2 Bill of Materials.....	15
6.3 Reference.....	15
<b>7 Revision History</b> .....	15

## List of Figures

Figure 4-1. TPS562209EVM-601 Efficiency.....	6
Figure 4-2. TPS562209EVM-601 Light Load Efficiency.....	6
Figure 4-3. TPS562209EVM-601 Load Regulation.....	7
Figure 4-4. TPS562209EVM-601 Line Regulation.....	7
Figure 4-5. TPS562209EVM-601 Load Transient Response, 25% to 75% Load Step.....	8
Figure 4-6. TPS562209EVM-601 Output Voltage Ripple, $I_{OUT} = 2\text{ A}$ .....	9
Figure 4-7. TPS562209EVM-601 Input Voltage Ripple, $I_{OUT} = 2\text{ A}$ .....	9
Figure 4-8. TPS562209EVM-601 Start-Up Relative to $V_{IN}$ .....	10
Figure 4-9. TPS562209EVM-601 Start-Up Relative to EN.....	10
Figure 4-10. TPS562209EVM-601 Shut-Down Relative to $V_{IN}$ .....	11
Figure 4-11. TPS562209EVM-601 Shut-Down Relative to EN.....	11
Figure 5-1. Top Assembly.....	12
Figure 5-2. Bottom Layer.....	13
Figure 6-1. TPS562209EVM-601 Schematic Diagram.....	14

## List of Tables

Table 1-1. Input Voltage and Output Current Summary.....	3
--	---

Table 2-1. TPS562209EVM-601 Performance Specifications Summary.....	4
Table 3-1. Output Voltages.....	4
Table 4-1. Connection and Test Points.....	5
Table 6-1. Bill of Materials.....	15

**Trademarks**

D-CAP2™ is a trademark of Texas Instruments.

All trademarks are the property of their respective owners.

## 1 Introduction

The TPS562209 is a single, adaptive on-time, D-CAP2™-mode, synchronous buck converter requiring a very low external component count. The D-CAP2 control circuit is optimized for low-ESR output capacitors such as POSCAP, SP-CAP, or ceramic types and features fast transient response with no external compensation. The switching frequency is internally set at a nominal 650 kHz. The high-side and low-side switching MOSFETs are incorporated inside the TPS562209 package along with the gate-drive circuitry. The low drain-to-source on resistance of the MOSFETs allows the TPS562209 to achieve high efficiencies and helps keep the junction temperature low at high output currents. The TPS562209 dc/dc synchronous converter is designed to provide up to a 2-A output from an input voltage source of 4.5 V to 17 V. The output voltage range is from 0.8 V to 6.5 V. Rated input voltage and output current ranges for the evaluation module are given in [Table 1-1](#).

The TPS562209EVM-601 evaluation module (EVM) is a single, synchronous buck converter providing 1.05 V at 2 A from 4.5-V to 17-V input. This user's guide describes the TPS562209EVM-601 performance.

**Table 1-1. Input Voltage and Output Current Summary**

EVM	Input Voltage Range	Output Current Range
TPS562209EVM-601	$V_{IN} = 4.5 \text{ V to } 17 \text{ V}$	0 A to 2 A

## 2 Performance Specification Summary

A summary of the TPS562209EVM-601 performance specifications is provided in [Table 2-1](#). Specifications are given for an input voltage of  $V_{IN} = 12\text{ V}$  and an output voltage of  $1.05\text{ V}$ , unless otherwise noted. The ambient temperature is  $25^{\circ}\text{C}$  for all measurement, unless otherwise noted.

**Table 2-1. TPS562209EVM-601 Performance Specifications Summary**

Specifications		Test Conditions	Min	Typ	Max	Unit
Input voltage range ( $V_{IN}$ )			4.5	12	17	V
CH1	Output voltage		1.05			V
	Operating frequency	$V_{IN} = 12\text{ V}, I_O = 2\text{ A}$	650			kHz
	Output current range		0	2		A
	Over current limit	$V_{IN} = 12\text{ V}, L_O = 2.2\text{ }\mu\text{H}$				A
	Output ripple voltage	$V_{IN} = 12\text{ V}, I_O = 2\text{ A}$	20			mV <sub>PP</sub>

## 3 Modifications

These evaluation modules are designed to provide access to the features of the TPS562209. Some modifications can be made to this module.

### 3.1 Output Voltage Setpoint

To change the output voltage of the EVMs, it is necessary to change the value of resistor R5. Changing the value of R5 can change the output voltage above  $0.765\text{ V}$ . The value of R5 for a specific output voltage can be calculated using [Equation 1](#).

$$R5 = \frac{R6 \times (V_{OUT} - 0.765\text{ V})}{0.765\text{ V}} \quad (1)$$

[Table 3-1](#) lists the R5 values for some common output voltages. For higher output voltages of  $1.8\text{ V}$  or above, a feedforward capacitor (C9) may be used to improve phase margin. Pads for this component (C9) are provided on the printed-circuit board (PCB). Note that the values given in [Table 3-1](#) are standard values and not the exact value calculated using [Table 3-1](#).

**Table 3-1. Output Voltages**

Output Voltage (V)	R5 (k $\Omega$ )	R6 (k $\Omega$ )	C9 (pF)	L1 ( $\mu\text{H}$ )			C6 + C7 + C8 ( $\mu\text{F}$ )
				Min	Typ	Max	
1.0	15.4	49.9		1.5	2.2	4.7	20 - 68
1.05	18.7	49.9		1.5	2.2	4.7	20 - 68
1.2	28.7	49.9		1.5	2.2	4.7	20 - 68
1.5	47.5	49.9		1.5	2.2	4.7	20 - 68
1.8	68.1	49.9	optional, 10 pF max	1.5	2.2	4.7	20 - 68
2.5	113	49.9	optional, 10 pF max	2.2	3.3	4.7	20 - 68
3.3	165	49.9	optional, 10 pF max	2.2	3.3	4.7	20 - 68
5.0	274	49.9	optional, 10 pF max	3.3	4.7	4.7	20 - 68
6.5	374	49.9	optional, 10 pF max	3.3	4.7	4.7	20 - 68

## 4 Test Setup and Results

This section describes how to properly connect, set up, and use the TPS562209EVM-601. The section also includes test results typical for the evaluation modules and efficiency, output load regulation, output line regulation, load transient response, output voltage ripple, input voltage ripple, start-up, and switching frequency.

### 4.1 Input/Output Connections

The TPS562209EVM-601 is provided with input/output connectors and test points as shown in [Table 4-1](#). A power supply capable of supplying 2 A must be connected to J1 through a pair of 20-AWG wires. The load must be connected to J2 through a pair of 20-AWG wires. The maximum load current capability is 2 A. Wire lengths must be minimized to reduce losses in the wires. Test point TP1 provides a place to monitor the  $V_{IN}$  input voltages with TP2 providing a convenient ground reference. TP7 is used to monitor the output voltage with TP8 as the ground reference.

**Table 4-1. Connection and Test Points**

Reference Designator	Function
J1	$V_{IN}$ (see <a href="#">Table 1-1</a> for $V_{IN}$ range)
J2	$V_{OUT}$ , 1.05 V at 2-A maximum
JP1	EN control. Shunt EN to GND to disable, shunt EN to $V_{IN}$ to enable.
TP1	$V_{IN}$ positive monitor point
TP2	GND monitor test point
TP3	EN test point
TP4	Switch node test point
TP5	Test point for loop response measurements
TP6	$V_{OUT}$ positive monitor point
TP7	GND monitor test point

### 4.2 Start-Up Procedure

1. Ensure that the jumper at JP1 (Enable control) pins 1 and 2 are covered to shunt EN to GND, disabling the output.
2. Apply appropriate  $V_{IN}$  voltage to VI (J1-2) and GND (J1-1).
3. Move the jumper at JP1 (Enable control) from pins 1 and 2 (EN and GND), to pins 2 and 3 (EN and  $V_{IN}$ ) enabling the output.

### 4.3 Efficiency

Figure 4-1 shows the efficiency for the TPS562209EVM-601 at an ambient temperature of 25°C.

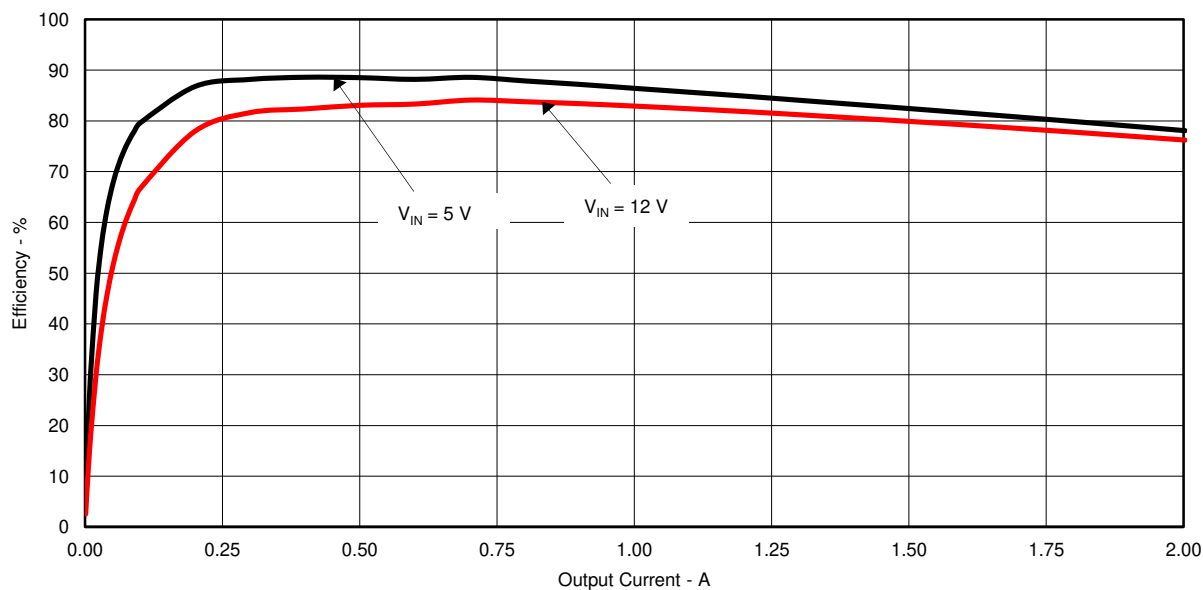

Figure 4-1. TPS562209EVM-601 Efficiency

Figure 4-2 shows the efficiency at light loads for the TPS562209EVM-601 at an ambient temperature of 25°C.

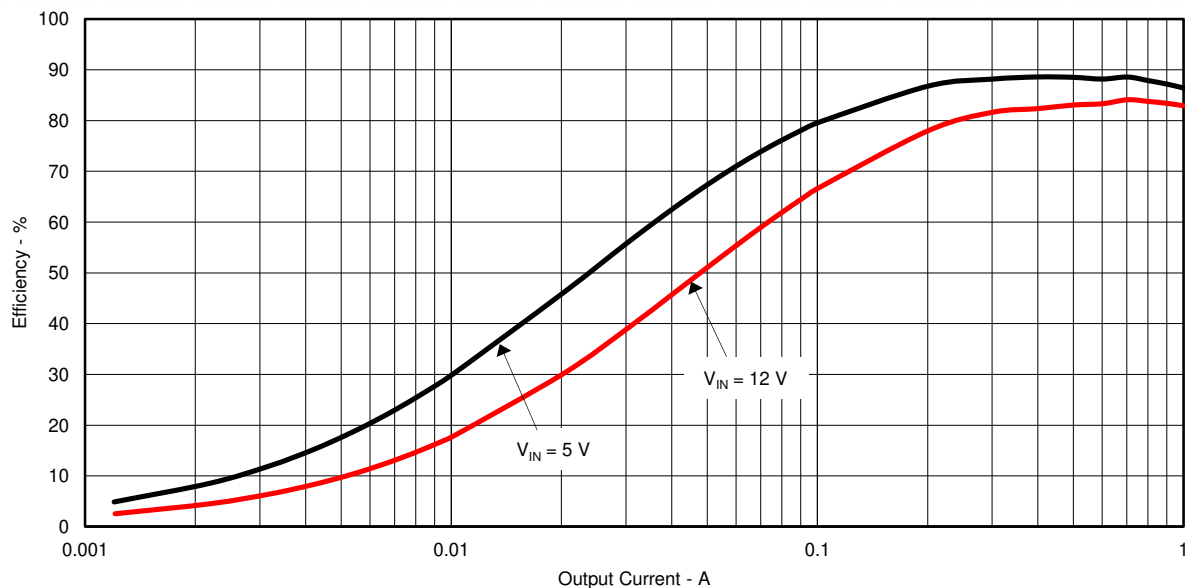
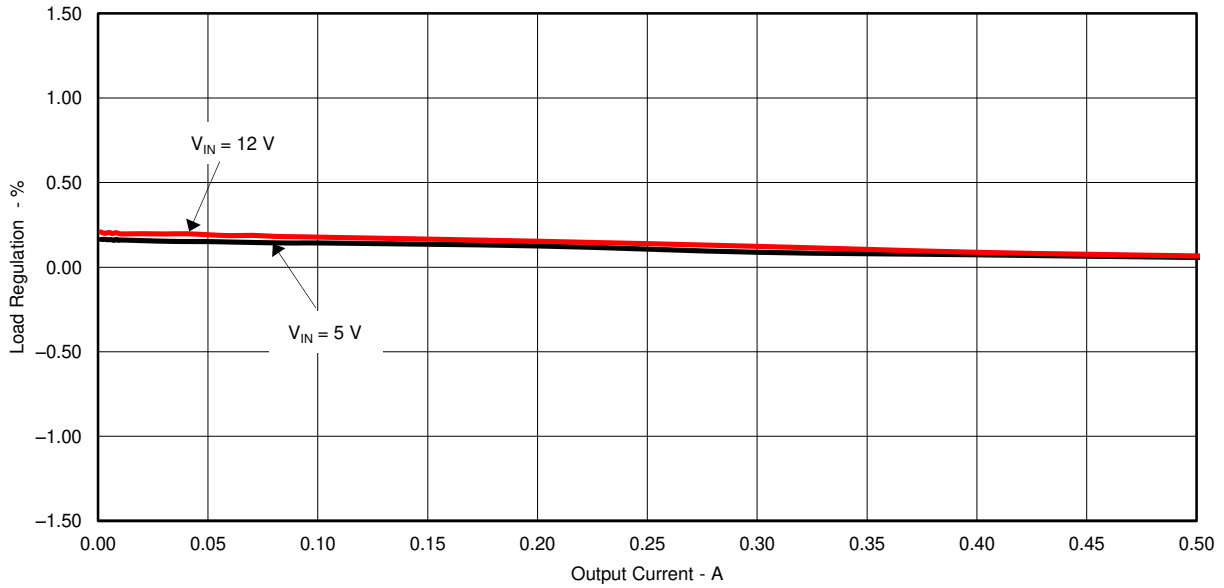

Figure 4-2. TPS562209EVM-601 Light Load Efficiency

### 4.4 Load Regulation

The load regulation for the TPS562209EVM-601 is shown in [Figure 4-3](#).



**Figure 4-3. TPS562209EVM-601 Load Regulation**

### 4.5 Line Regulation

The line regulation for the TPS562209EVM-601 is shown in [Figure 4-4](#).

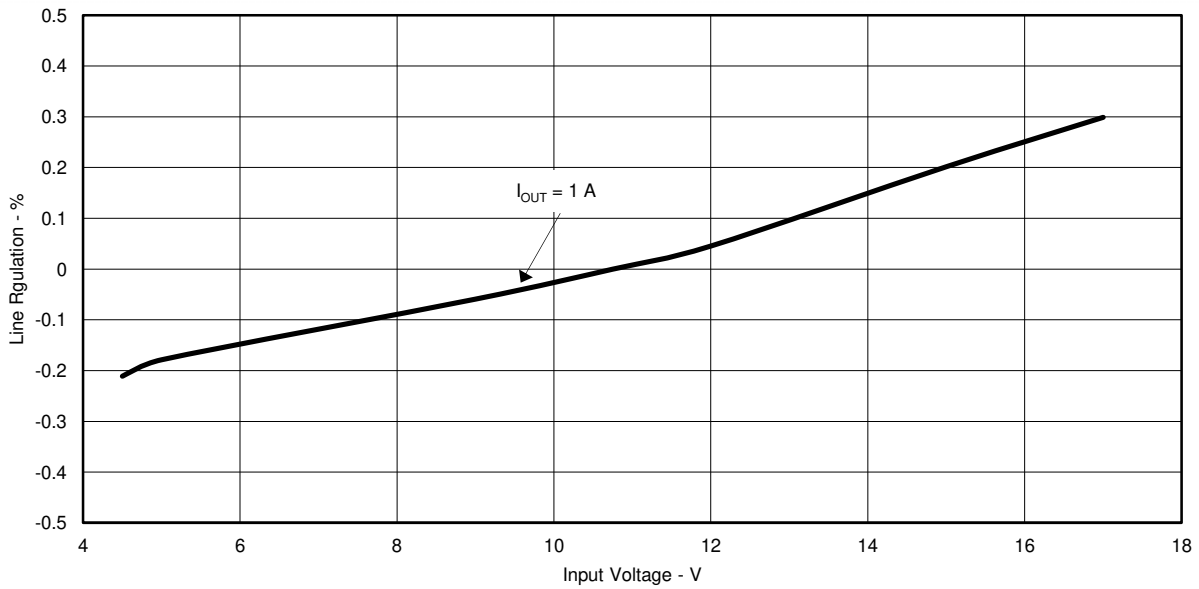

**Figure 4-4. TPS562209EVM-601 Line Regulation**

## 4.6 Load Transient Response

The TPS562209EVM-601 response to load transient is shown in [Figure 4-5](#). The current steps and slew rates are indicated in the figures. Total peak-to-peak voltage variation is as shown.

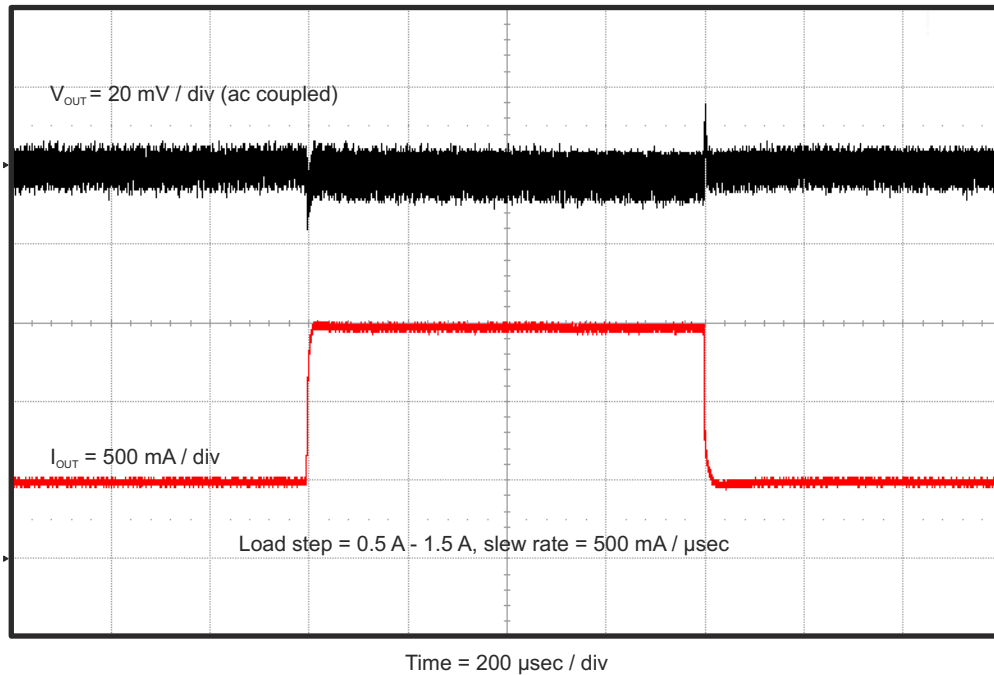
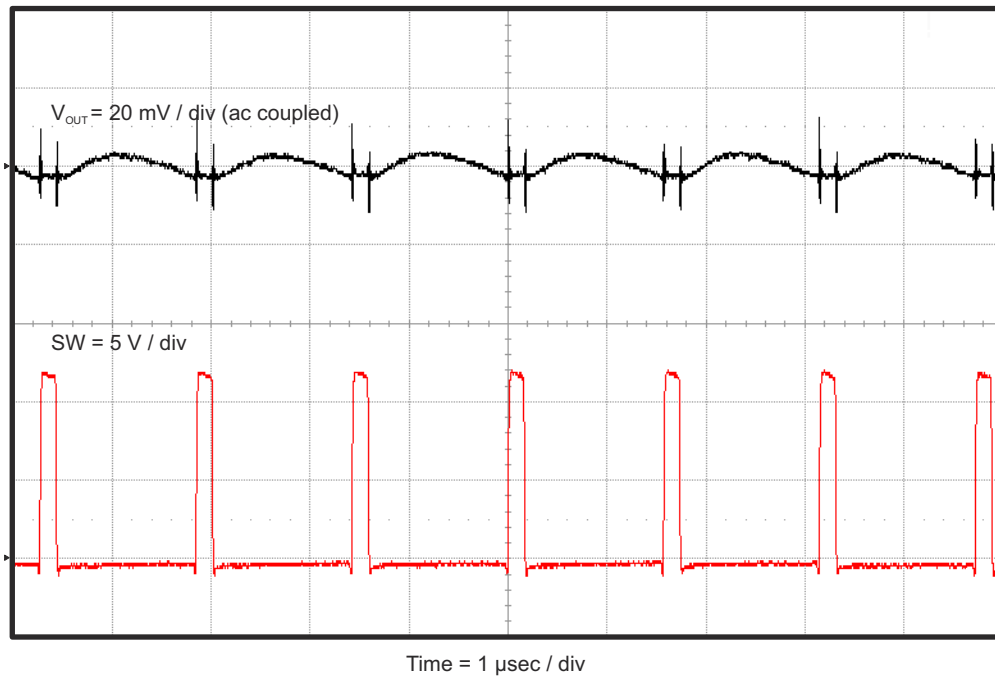

**Figure 4-5. TPS562209EVM-601 Load Transient Response, 25% to 75% Load Step**



## 4.7 Output Voltage Ripple

The TPS562209EVM-601 output voltage ripple is shown in [Figure 4-6](#). The output current is as indicated.



**Figure 4-6. TPS562209EVM-601 Output Voltage Ripple,  $I_{OUT} = 2 \text{ A}$**

## 4.8 Input Voltage Ripple

The TPS562209EVM-601 input voltage ripple is shown in [Figure 4-7](#). The output current is as indicated.

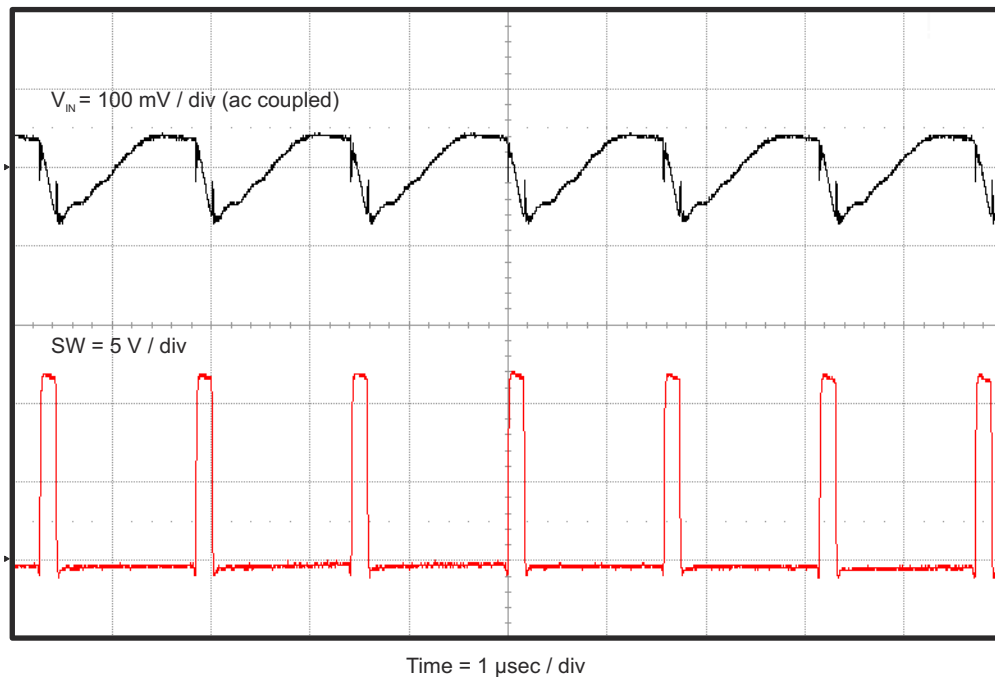

**Figure 4-7. TPS562209EVM-601 Input Voltage Ripple,  $I_{OUT} = 2 \text{ A}$**

### 4.9 Start-Up

The TPS562209EVM-601 start-up waveform relative to  $V_{IN}$  is shown in [Figure 4-8](#). Load = 1  $\Omega$  resistive.

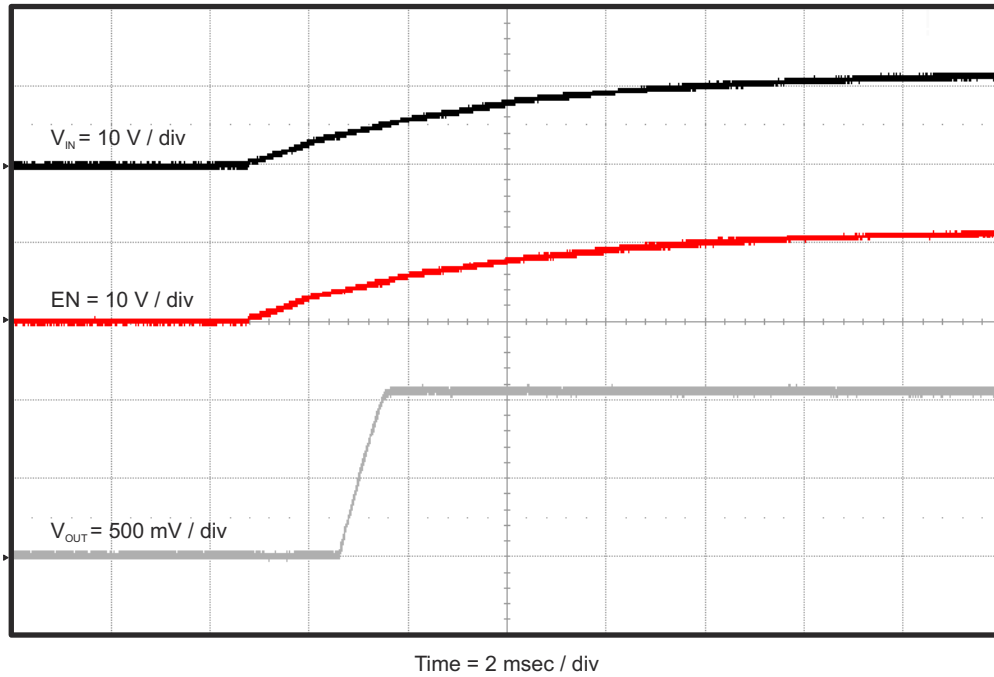

**Figure 4-8. TPS562209EVM-601 Start-Up Relative to  $V_{IN}$**

The TPS562209EVM-601 start-up waveform relative to enable (EN) is shown in [Figure 4-9](#). Load = 1  $\Omega$  resistive.

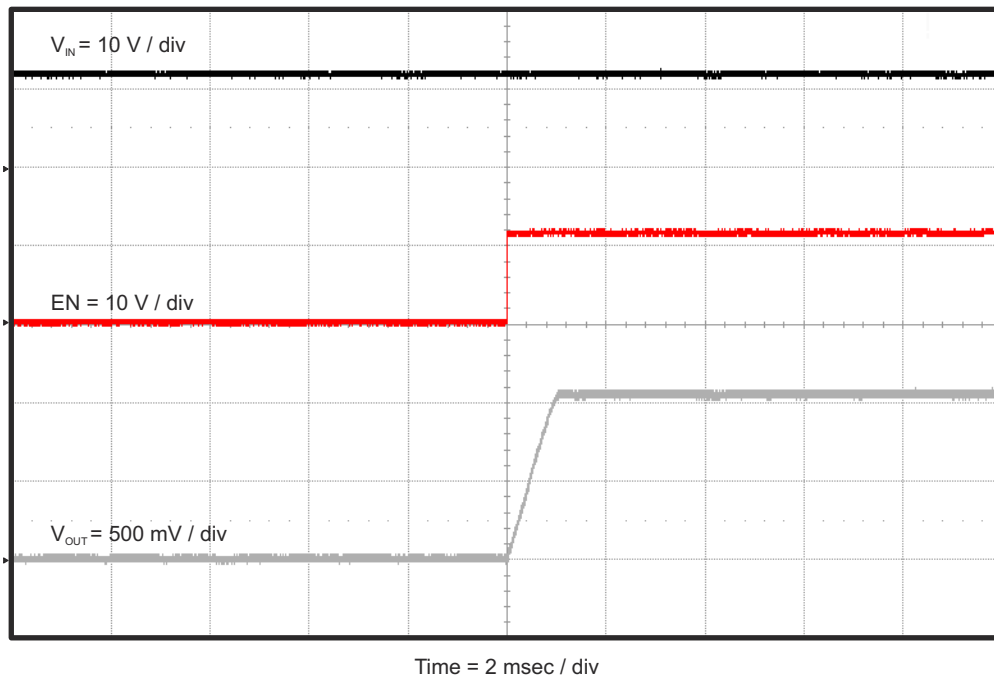

**Figure 4-9. TPS562209EVM-601 Start-Up Relative to EN**

## 4.10 Shut-Down

The TPS562209EVM-601 shut-down waveform relative to  $V_{IN}$  is shown in [Figure 4-10](#). Load = 1  $\Omega$  resistive.

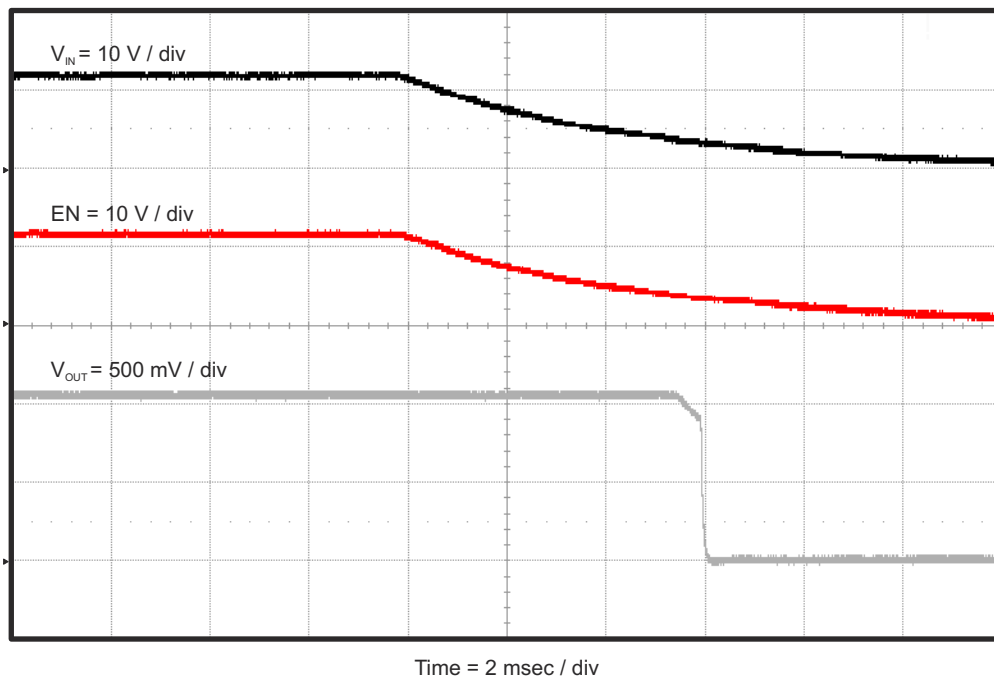

**Figure 4-10. TPS562209EVM-601 Shut-Down Relative to  $V_{IN}$**

The TPS562209EVM-601 shut-down waveform relative to EN is shown in [Figure 4-11](#). Load = 1  $\Omega$  resistive.

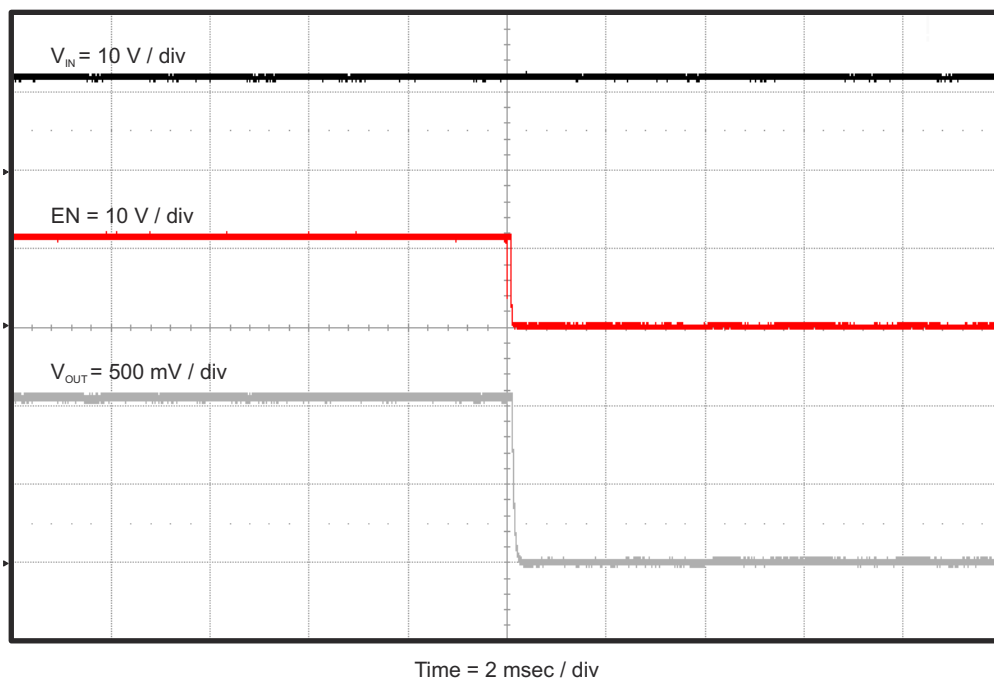

**Figure 4-11. TPS562209EVM-601 Shut-Down Relative to EN**

## 5 Board Layout

This section provides a description of the TPS562209EVM-601, board layout, and layer illustrations.

### 5.1 Layout

The board layout for the TPS562209EVM-601 is shown in [Figure 5-1](#) and [Figure 5-2](#). The top layer contains the main power traces for VIN, VOUT, and ground. Also on the top layer are connections for the pins of the TPS562209 and a large area filled with ground. Most of the signal traces also are located on the top side. The input decoupling capacitors, C1, C2, and C3 are located as close to the IC as possible. The input and output connectors, test points, and all of the components are located on the top side. The bottom layer is a ground plane along with the switching node copper fill, signal ground copper fill and the feed back trace from the point of regulation to the top of the resistor divider network.

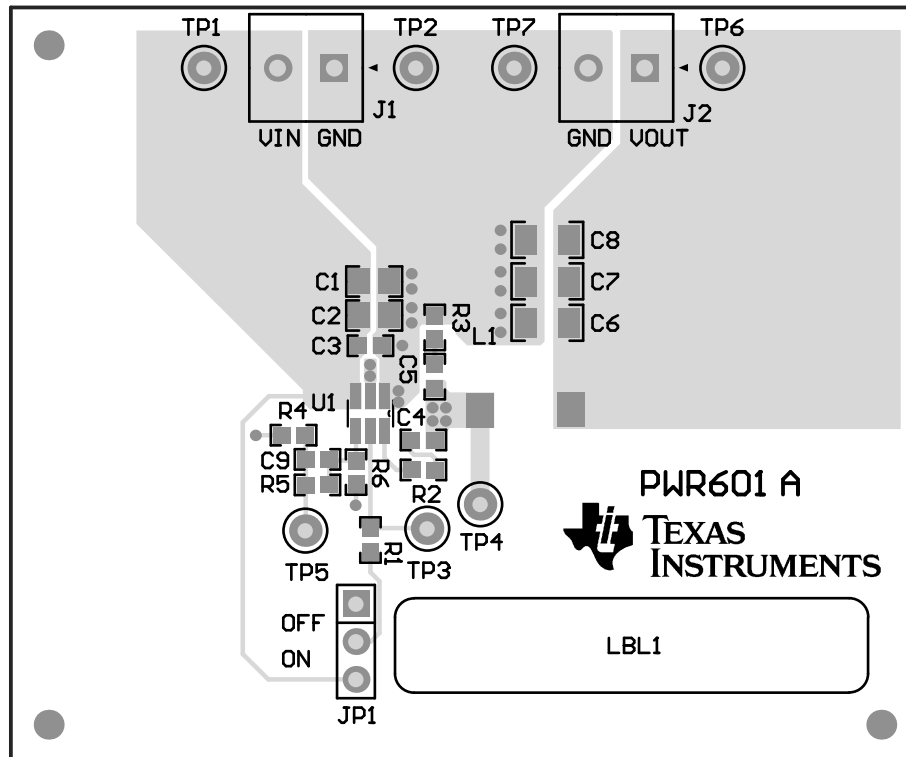

**Figure 5-1. Top Assembly**

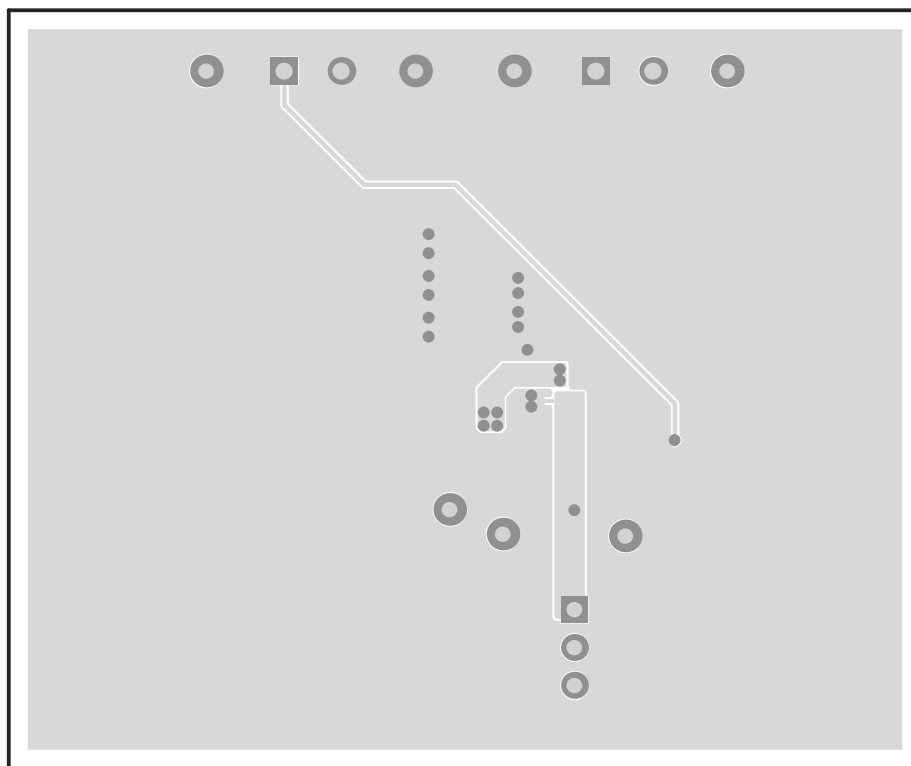

**Figure 5-2. Bottom Layer**

## 6 Schematic, Bill of Materials, and Reference

### 6.1 Schematic

Figure 6-1 is the schematic for the TPS562209EVM-601.

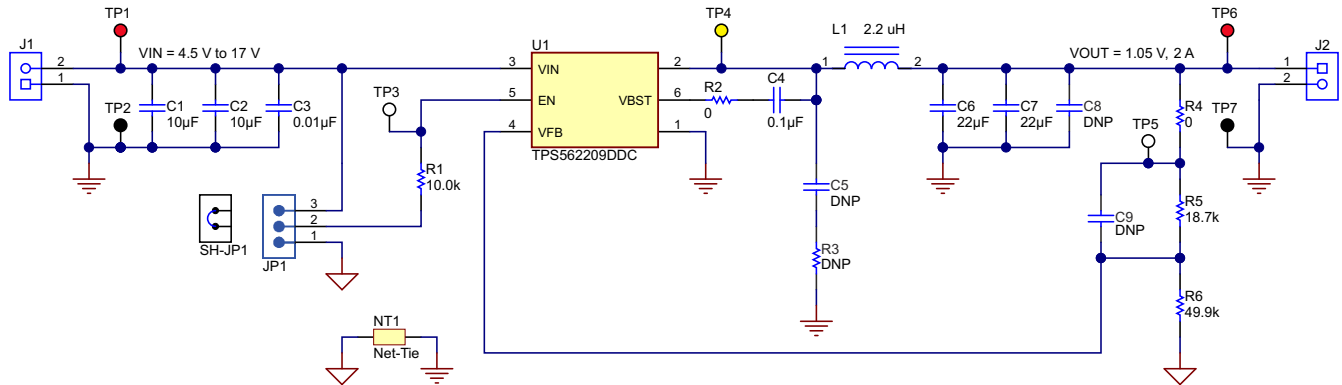

Figure 6-1. TPS562209EVM-601 Schematic Diagram

## 6.2 Bill of Materials

**Table 6-1. Bill of Materials**

QTY	Value	Description	Package Reference	Part Number	Manufacturer
1		Printed-Circuit Board		PWR601	Any
2	10uF	CAP, CERM, 10uF, 25V, +/-10%, X5R, 0805	0805	C2012X5R1E106K125AB	TDK
1	0.01uF	CAP, CERM, 0.01uF, 50V, +/-10%, X7R, 0603	0603	C1608X7R1H103K	TDK
1	0.1uF	CAP, CERM, 0.1uF, 50V, +/-10%, X7R, 0603	0603	C1608X7R1H104K	TDK
2	22uF	CAP, CERM, 22uF, 6.3V, +/-20%, X5R, 1206	1206	C3216X5R0J226K	TDK
2	2x1	Conn Term Block, 2POS, 3.81mm, TH	2POS Terminal Block	1727010	Phoenix Contact
1	1x3	Header, TH, 100mil, 1x3, Gold plated, 230 mil above insulator	PBC03SAAN	PBC03SAAN	Sullins Connector Solutions
1	2.2 uH	Inductor, Power Line, Magnetic Shielded, ±30%	6.9x7.2 mm	CLF7045T2R2N	TDK
1		Thermal Transfer Printable Labels, 1.250" W x 0.250" H - 10,000 per roll	PCB Label 1.25"H x 0.250"W	THT-13-457-10	Brady
1	10.0k	RES, 10.0k ohm, 1%, 0.1W, 0603	0603	CRCW060310K0FKEA	Vishay-Dale
2	0	RES, 0 ohm, 5%, 0.1W, 0603	0603	ERJ-3GEY0R00V	Panasonic
1	18.7k	RES, 18.7k ohm, 1%, 0.1W, 0603	0603	CRCW060318K7FKEA	Vishay-Dale
1	49.9k	RES, 49.9k ohm, 1%, 0.1W, 0603	0603	CRCW060349K9FKEA	Vishay-Dale
1	1x2	Shunt, 2mm, Gold plated, Black	2mm Shunt, Closed Top	2SN-BK-G	Samtec
2	Red	Test Point, Miniature, Red, TH	Red Miniature Testpoint	5000	Keystone
2	Black	Test Point, Miniature, Black, TH	Black Miniature Testpoint	5001	Keystone
2	White	Test Point, Miniature, White, TH	White Miniature Testpoint	5002	Keystone
1	Yellow	Test Point, Miniature, Yellow, TH	Yellow Miniature Testpoint	5004	Keystone
1		4.5V to 17 V Input, 2-A Synchronous Step-Down SWIFT Converter, DDC0006A	DDC0006A	TPS562209DDC	Texas Instruments
0		CAP, CERM, 0603	0603		
0		CAP, CERM, 1206	1206		
0		CAP, CERM, 0603	0603		
0		RES, 0603	0603		

## 6.3 Reference

1. [TPS56220x 4.5 V to 17 V Input, 2-A Synchronous Step-Down Voltage Regulator in SOT-23 data sheet \(SLVSCB0\)](#)

## 7 Revision History

NOTE: Page numbers for previous revisions may differ from page numbers in the current version.

Changes from Revision * (January 2014) to Revision A (August 2021)	Page
• Updated user's guide title.....	3
• Updated the numbering format for tables, figures, and cross-references throughout the document. ....	3

## IMPORTANT NOTICE AND DISCLAIMER

TI PROVIDES TECHNICAL AND RELIABILITY DATA (INCLUDING DATA SHEETS), DESIGN RESOURCES (INCLUDING REFERENCE DESIGNS), APPLICATION OR OTHER DESIGN ADVICE, WEB TOOLS, SAFETY INFORMATION, AND OTHER RESOURCES "AS IS" AND WITH ALL FAULTS, AND DISCLAIMS ALL WARRANTIES, EXPRESS AND IMPLIED, INCLUDING WITHOUT LIMITATION ANY IMPLIED WARRANTIES OF MERCHANTABILITY, FITNESS FOR A PARTICULAR PURPOSE OR NON-INFRINGEMENT OF THIRD PARTY INTELLECTUAL PROPERTY RIGHTS.

These resources are intended for skilled developers designing with TI products. You are solely responsible for (1) selecting the appropriate TI products for your application, (2) designing, validating and testing your application, and (3) ensuring your application meets applicable standards, and any other safety, security, regulatory or other requirements.

These resources are subject to change without notice. TI grants you permission to use these resources only for development of an application that uses the TI products described in the resource. Other reproduction and display of these resources is prohibited. No license is granted to any other TI intellectual property right or to any third party intellectual property right. TI disclaims responsibility for, and you will fully indemnify TI and its representatives against, any claims, damages, costs, losses, and liabilities arising out of your use of these resources.

TI's products are provided subject to [TI's Terms of Sale](#) or other applicable terms available either on [ti.com](http://ti.com) or provided in conjunction with such TI products. TI's provision of these resources does not expand or otherwise alter TI's applicable warranties or warranty disclaimers for TI products.

TI objects to and rejects any additional or different terms you may have proposed.

Mailing Address: Texas Instruments, Post Office Box 655303, Dallas, Texas 75265  
Copyright © 2022, Texas Instruments Incorporated