

User's Guide

LM26400Y Step-Down Converter Evaluation Module User's Guide



Table of Contents

1 Introduction.....	2
2 Powering Up The Board.....	2
3 Board Schematic.....	3
4 PCB Layout.....	5
5 Typical Performance Characteristics.....	7
6 Revision History.....	8

Trademarks

All trademarks are the property of their respective owners.

1 Introduction

The LM26400Y demonstration board was designed to provide two 2A outputs at 1.2V and 2.5V respectively. It uses the HTSSOP package option of the LM26400Y for easier probing. The design emphasizes on the compactness of the LM26400Y PCB layout and is thermally optimized. The total solution size is about 20mm by 30mm. The board supports the conversion from an input voltage ranging from 5V to 20V down to output voltages of 1.2V and 2.5V. With the availability of a separate 5V rail and a couple of small bootstrap diodes, the board also supports an input voltage down to 3.3V with 2A output currents. The EN pins are pulled up to VIN by default for easy evaluation but can also be easily controlled by external logic.

The board also has two small C_{FF} capacitors (C12 and C13) installed for improved load step response and elimination of output voltage overshoot after a short-circuit release.

The board's specifications are:

Input Voltage: 5V to 20V

Maximum load current: 2A/output

Peak Current Limit: $\approx 3A$ at 25°C

Nominal Switching Frequency: 520 kHz

Output Voltages: 1.2V and 2.5V

Minimum load current: 0A

Measured Efficiency: 83% ($V_{IN} = 5V$, $I_{OUT2} = 2A$)

Size: 2 in. x 2 in.

2 Powering Up The Board

Since the EN pins are directly tied to the input voltage, starting up the board is a single-step procedure. Simply connect a voltage rail between 5V and 20V to the VIN and GND terminals and there should be 1.2V and 2.5V output at the corresponding terminals. Certain bench-top power supplies upon powering up may shoot up to their maximum output voltages momentarily before settling to the programmed value. If their maximum voltage is above 22V, it can damage the LM26400Y demonstration board. In this case, either connect the board after the input power supply is powered up, or use the current limit knob of the power supply to bring up the input voltage.

The linear soft-start ramps for the two output voltages should last about 1ms and 2ms. Load can be applied prior to power-up. If no load is applied, the two channels will operate in pulse skipping mode or discontinuous conduction mode. If an output is shorted either before or after start-up, removal of the short-circuit condition should bring the corresponding output back to normal voltage.

If additional output capacitors are desired, C8 and C9 on the back of the board are reserved for that purpose.

If it is desired to control the start-up and shutdown timing, connect the logic signals to the EN1 and/or EN2 pads on the back of the board. Make sure the voltages on the EN pads are never higher than VIN. If only a soft-start slope needs to be adjusted, simply change the corresponding SS capacitor (C5 or C6).

To operate between 3.3V and 5V of input voltage, populate D3 and D4 (on the back of the board) each with a SOT-23 Schottky diode such as the BAT54 and apply a 5V supply to the "5V_Bias" pad on the back. Do not exceed 6V on the 5V bias. The LM26400Y device itself can work with an input voltage as low as 3V. The demonstration board when using an external bootstrap bias can operate down to 3.3V under room temperature. This extra 0.3V requirement is due to the large duty cycle in the 2.5V channel being too close to the maximum allowed.

3 Board Schematic

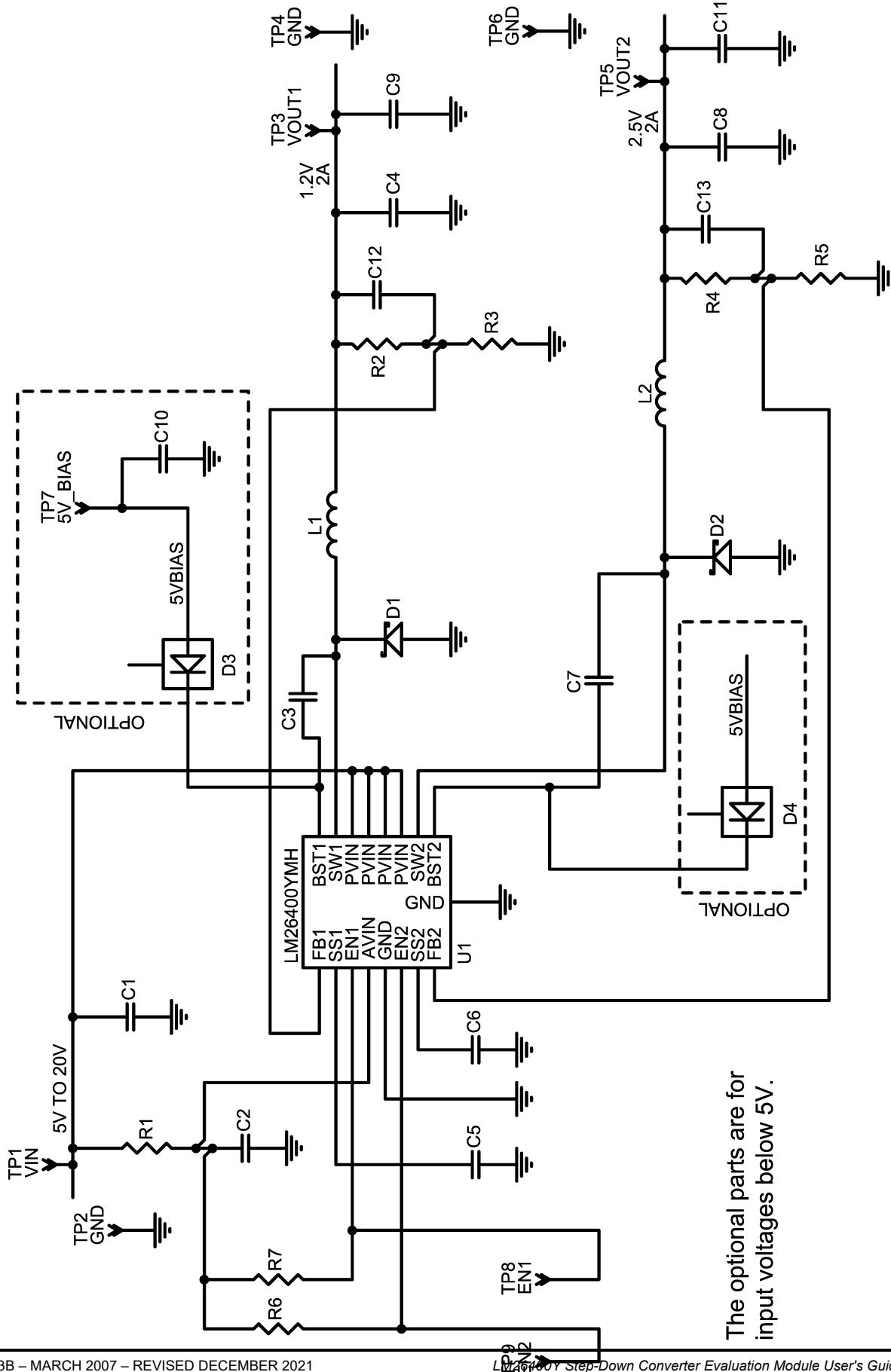

The optional parts are for input voltages below 5V.

Table 3-1. Bill of Materials

Item	Designator	Description	Manufacturer	Part No.	Qty.
1	C5, C6, C12, C13	0.022 μ F, 6.3V, X5R, 10%, 0402	Kemet	C0402C223K9PACTU	4
2	C2, C3, C7	0.1 μ F, 25V, X5R, 10%, 0402	Taiyo Yuden	TMK105BJ104KV-F	3
3	C1	10 μ F, 25V, X5R, 20%, 1210	Taiyo Yuden	TMK325BJ106MM-T	1
4	C11	47 μ F, 6.3V, X5R, 20%, 1210	Taiyo Yuden	JMK325BJ476MM-T	1
5	C4	100 μ F, 6.3V, X5R, 20%, 1210	Taiyo Yuden	JMK325BJ107MM-T	1
6	D1, D2	2A, 30V, SMB	IR	20BQ030TRPBF	2
7	L1	5 μ H, 2.2A, 23m Ω , 7x7x2.8mm ³	Sumida	CDRH6D26NP-5R0NC	1
8	L2	8.7 μ H, 2.2A, 25m Ω , 7x7x4mm ³	Sumida	CDRH6D38NP-8R7NC	1
9	R1	4.7 Ω , 1%, 0402	Vishay	CRCW04024R70FNED	1
10	R2, R3, R5	5.9k Ω , 1%, 0402	Vishay	CRCW040259R0FKED	3
11	R4, R6, R7	18.7k Ω , 1%, 0402	Vishay	CRCW0402187RFKED	3
12	TP1-TP6	0.094" Diameter Solder Terminal	Cambion	160-1026-02-01-00	6
13	U1	Dual 2A, 20V, 500kHz PWM Switcher, HTSSOP-16	TI	LM26400	1

4 PCB Layout

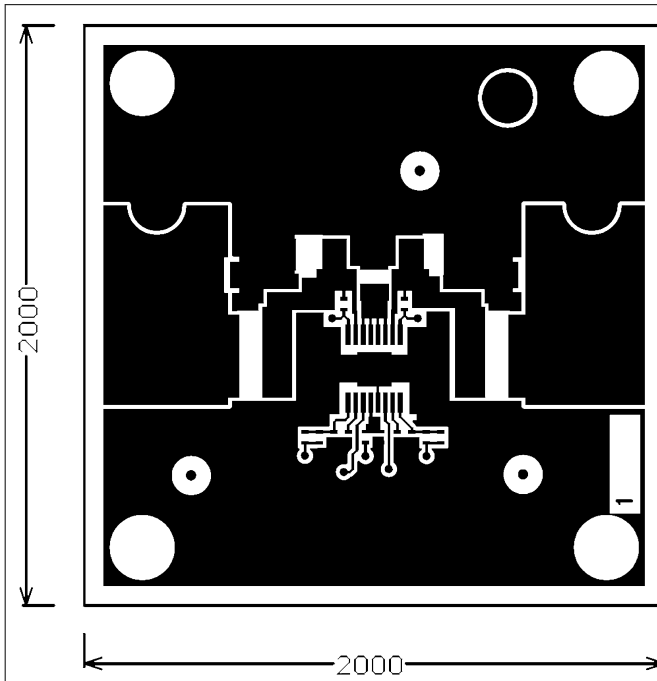

880013055-003 rev A

Figure 4-1. Top Copper

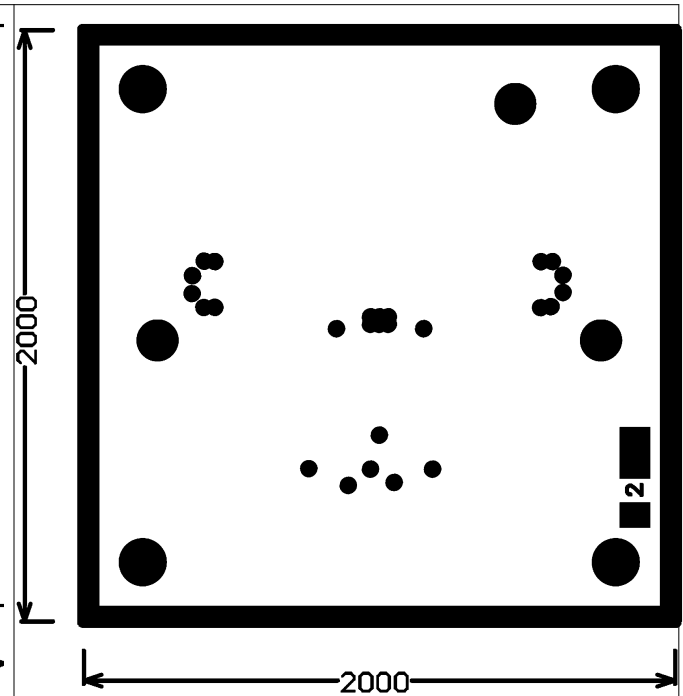

880013055-003 rev A

Figure 4-2. Ground Plane

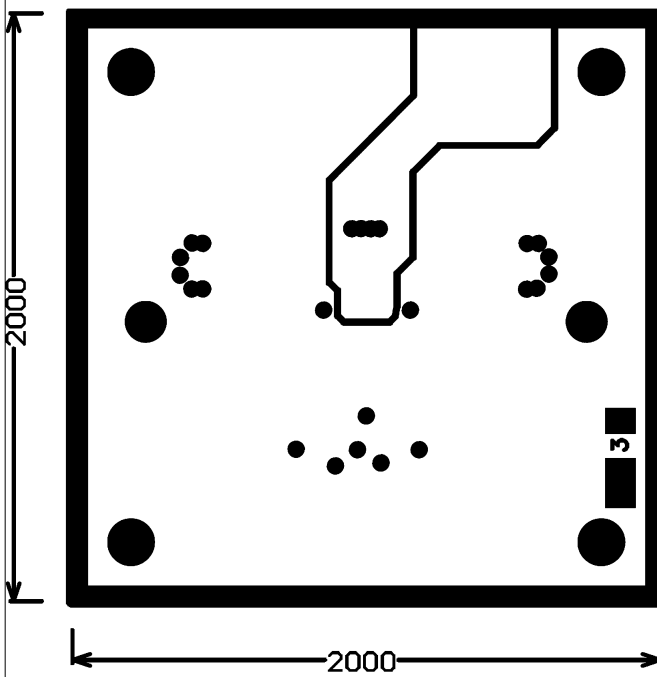

880013055-003 rev A

Figure 4-3. Power Plane

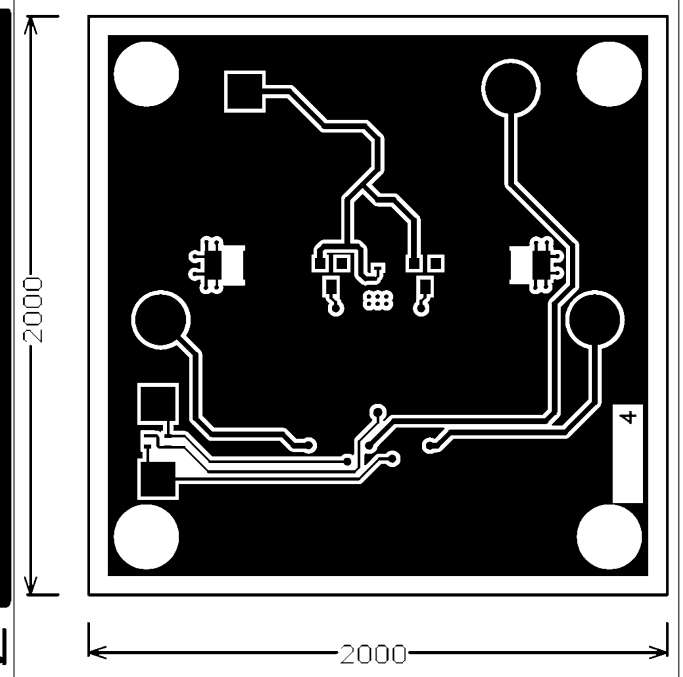

880013055-003 rev A

Figure 4-4. Bottom Copper

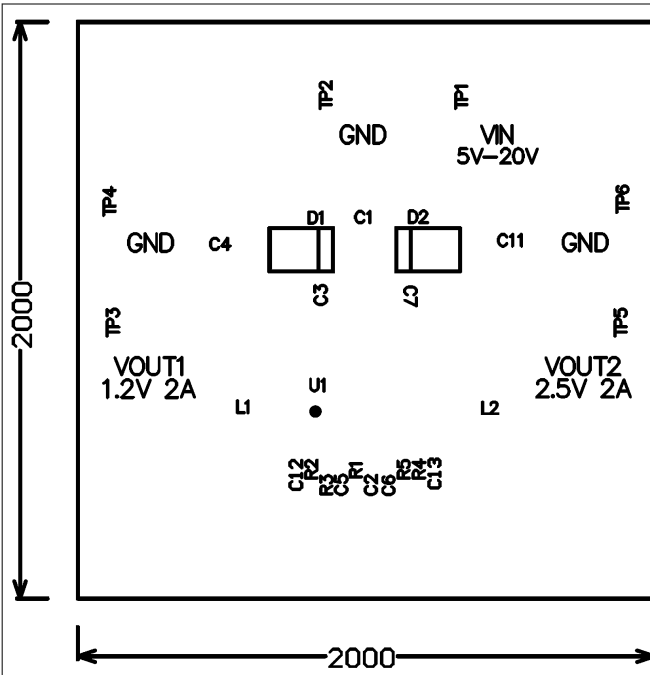

880013055-003 rev A

Figure 4-5. Top Silkscreen

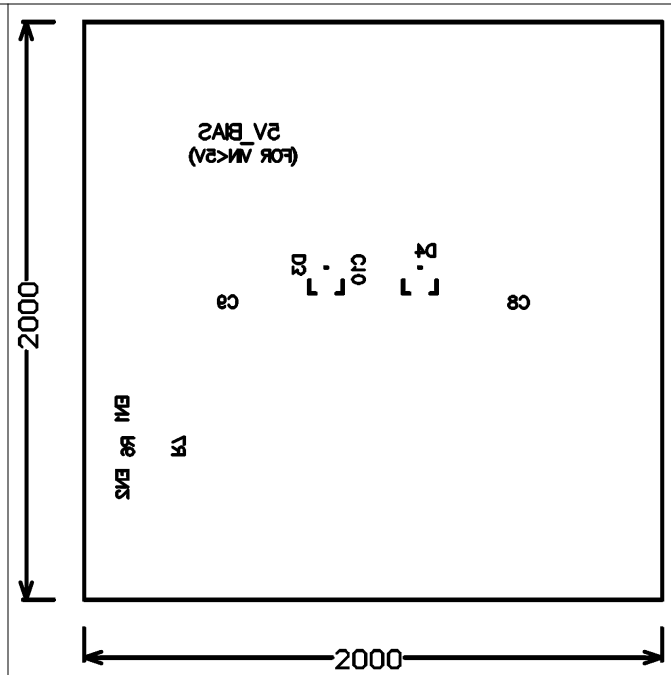

880013055-003 rev A

Figure 4-6. Bottom Silkscreen

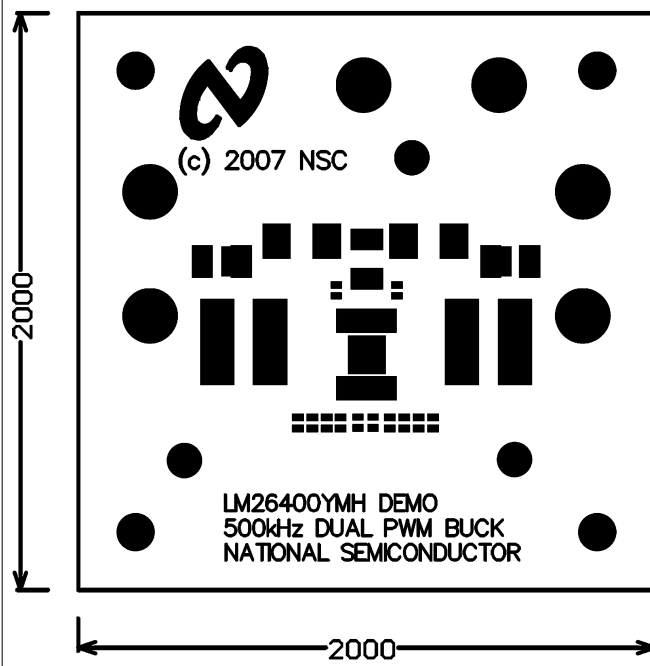

880013055-003 rev A

Figure 4-7. Top Soldermask

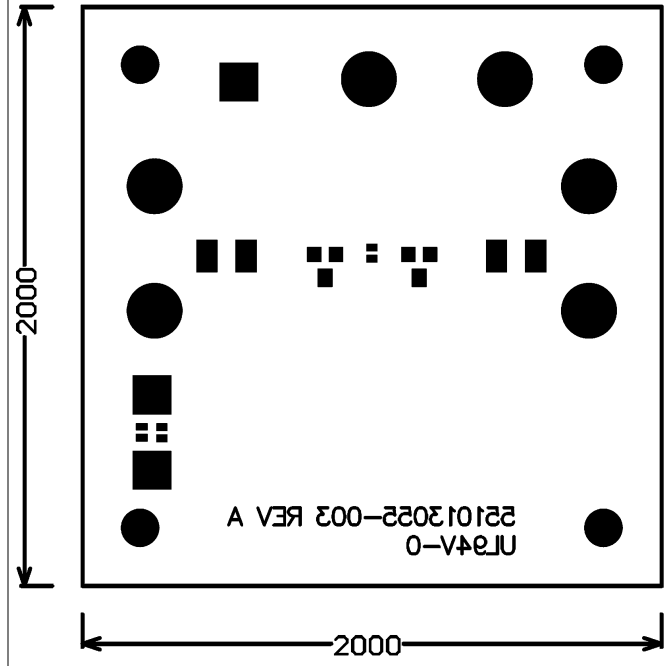

880013055-003 rev A

Figure 4-8. Bottom Soldermask

5 Typical Performance Characteristics

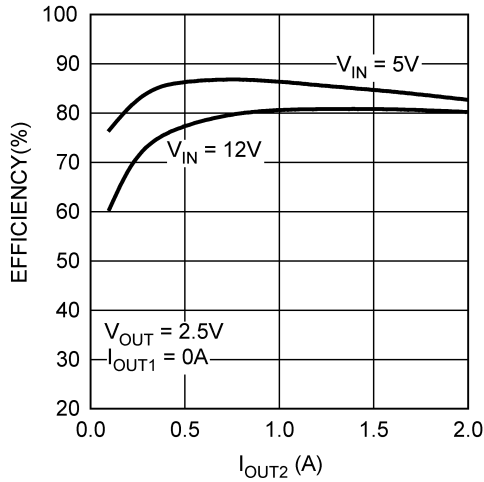

Figure 5-1. Efficiency

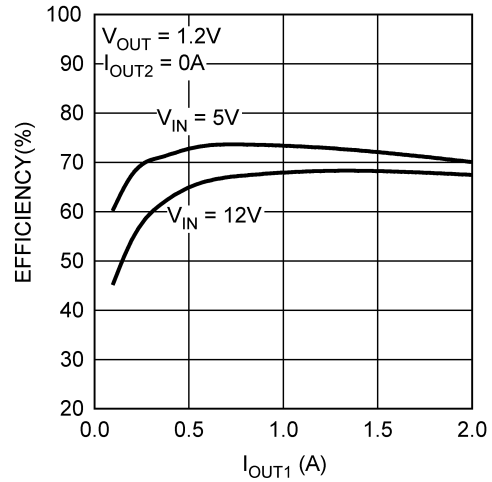

Figure 5-2. Efficiency

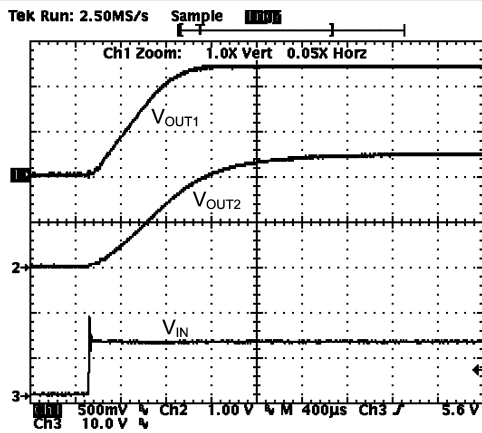

Figure 5-3. Start-up

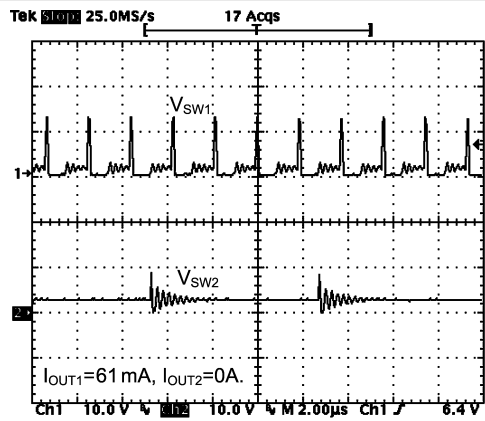

Figure 5-4. Steady State (Ch1 = DCM, Ch2 = Pulse Skipping)

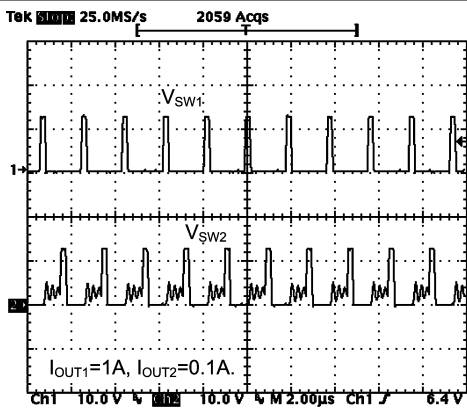

Figure 5-5. Steady State (Ch1 = CCM, Ch2 = DCM)

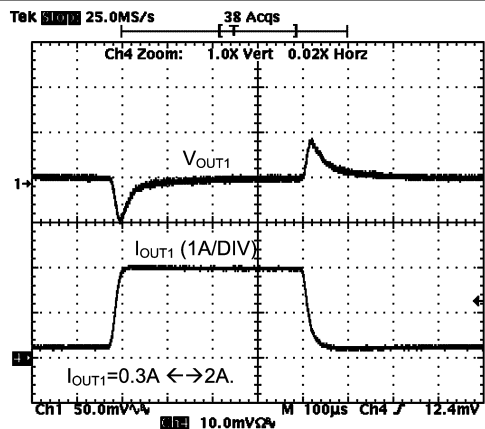

Figure 5-6. Load Step Response (Slew Rate = 0.25A/ μ s)

6 Revision History

NOTE: Page numbers for previous revisions may differ from page numbers in the current version.

Changes from Revision A (April 2013) to Revision B (December 2021)	Page
• Updated the numbering format for tables, figures, and cross-references throughout the document.	2
• Updated the user's guide title.....	2

IMPORTANT NOTICE AND DISCLAIMER

TI PROVIDES TECHNICAL AND RELIABILITY DATA (INCLUDING DATA SHEETS), DESIGN RESOURCES (INCLUDING REFERENCE DESIGNS), APPLICATION OR OTHER DESIGN ADVICE, WEB TOOLS, SAFETY INFORMATION, AND OTHER RESOURCES "AS IS" AND WITH ALL FAULTS, AND DISCLAIMS ALL WARRANTIES, EXPRESS AND IMPLIED, INCLUDING WITHOUT LIMITATION ANY IMPLIED WARRANTIES OF MERCHANTABILITY, FITNESS FOR A PARTICULAR PURPOSE OR NON-INFRINGEMENT OF THIRD PARTY INTELLECTUAL PROPERTY RIGHTS.

These resources are intended for skilled developers designing with TI products. You are solely responsible for (1) selecting the appropriate TI products for your application, (2) designing, validating and testing your application, and (3) ensuring your application meets applicable standards, and any other safety, security, regulatory or other requirements.

These resources are subject to change without notice. TI grants you permission to use these resources only for development of an application that uses the TI products described in the resource. Other reproduction and display of these resources is prohibited. No license is granted to any other TI intellectual property right or to any third party intellectual property right. TI disclaims responsibility for, and you will fully indemnify TI and its representatives against, any claims, damages, costs, losses, and liabilities arising out of your use of these resources.

TI's products are provided subject to [TI's Terms of Sale](#) or other applicable terms available either on ti.com or provided in conjunction with such TI products. TI's provision of these resources does not expand or otherwise alter TI's applicable warranties or warranty disclaimers for TI products.

TI objects to and rejects any additional or different terms you may have proposed.

Mailing Address: Texas Instruments, Post Office Box 655303, Dallas, Texas 75265
Copyright © 2022, Texas Instruments Incorporated