

AN-1790 LM20323 Evaluation Board

1 Introduction

This evaluation board provides a solution to examine the full featured LM20323 buck switching regulator that is capable of driving up to 3A of load current. This device features a 500 kHz fixed oscillator allowing the device to reach a good compromise between switching losses and inductor size. The LM20323 is capable of down converting from an input voltage between 4.5V and 36V. Fault protection features include cycle-by-cycle current limit, output power good, and output over-voltage protection. The dual function soft-start/tracking pin can be used to control the startup response of the LM20323, and the precision enable pin can be used to easily sequence the LM20323 in applications with sequencing requirements.

The LM20323 evaluation board has been optimized to work from 4.5V to 25V achieving a balance between overall solution size with the efficiency of the regulator. The evaluation board measures just under 2" x 2" on a four layer PCB, and exhibits a thermal characteristic of 27 °C/W with no air flow. The power stage and compensation components of the LM20323 evaluation board have been optimized for an input voltage of 12V, but for testing purposes, the input can be varied across the entire operating range. The output voltage of the evaluation board is nominally 3.3V, but this voltage can be easily changed by replacing one of the feedback resistors (R5 or R6).

2 Evaluation Board Schematic

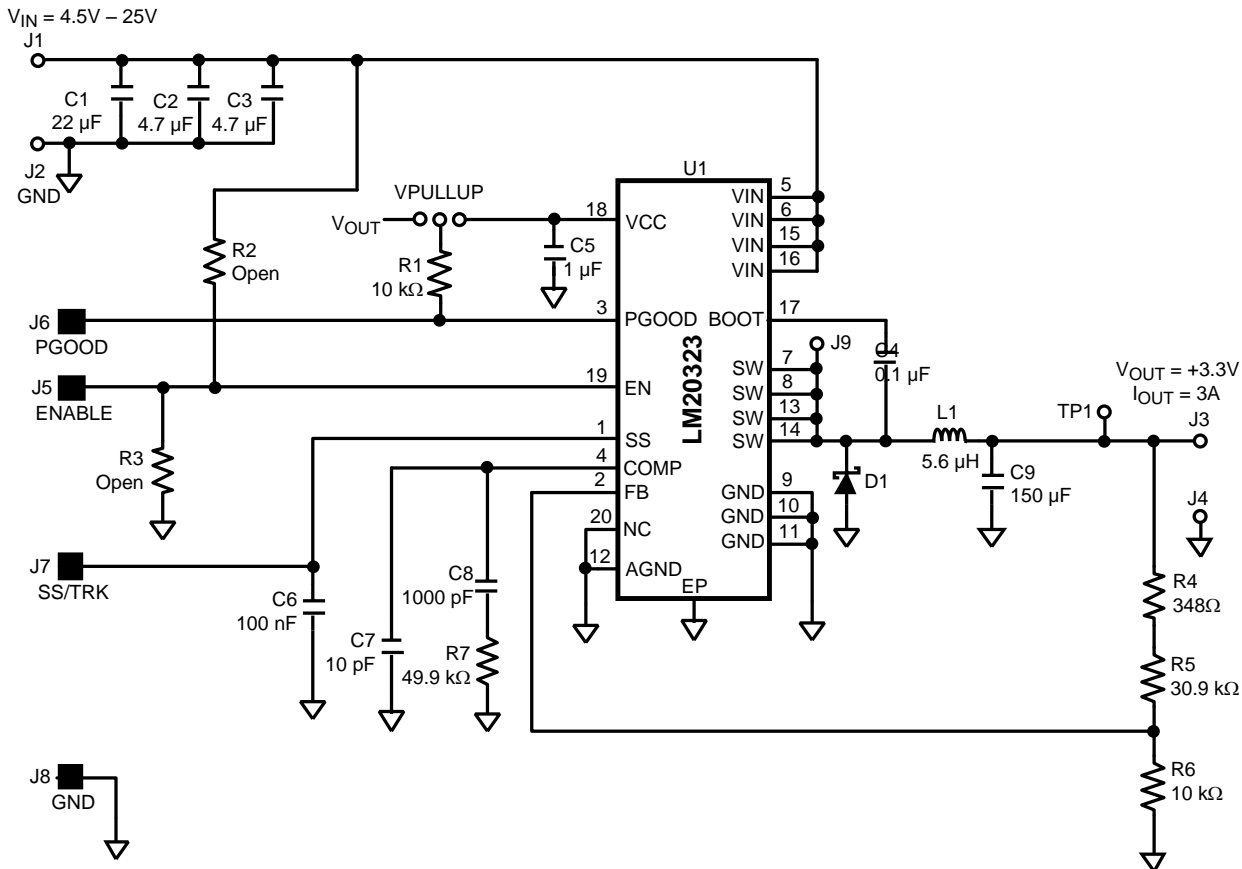

3 Powering and Loading Considerations

Read this entire page prior to attempting to power the evaluation board.

3.1 Quick Setup Procedure

1. Set the input source current limit to 3A. Turn off the input source. Connect the positive output of the input source to J1 and the negative output to J2.
2. Connect the load, with 3A capability, to J3 for the positive connection and J4 for the negative connection.
3. The ENABLE pin, J5, should be left open for normal operation.
4. Set the input source voltage to 12V and the load to 0.1A. The load voltage should be in regulation with a nominal 3.3V output.
5. Slowly increase the load while monitoring the load voltage at J3 and J4. It should remain in regulation with a nominal 3.3V output as the load is increased up to 3 Amp.
6. Slowly sweep the input source voltage from 4.5V to 25V. The load voltage should remain in regulation with a nominal 3.3V output. If desired the output of the device can be disabled by connecting the ENABLE pin (J5) to GND (J8).
7. The pull-up voltage for PGOOD can be selected by using the JP1 shunt to connect VPULLUP to VOUT or VCC.

3.2 Powering Up

It is suggested that the load power be kept low during the first power up. Set the current limit of the input source to provide about 1.5 times the anticipated wattage of the load. Once the device is powered up, immediately check for 3.3 volts at the output.

A quick efficiency check is the best way to confirm that everything is operating properly. If something is amiss you can be reasonably sure that it will affect the efficiency adversely. Few parameters can be incorrect in a switching power supply without creating losses and potentially damaging heat.

3.3 Over Current Protection

The evaluation board is configured with cycle-by-cycle over-current protection. This function is completely contained in the LM20323. The peak current is limited to approximately 5.2A.

Table 1. Connection Descriptions

Terminal Silkscreen	Description
VIN	This terminal is the input voltage to the device. The evaluation board will operation over the input voltage range of 4.5V to 25V. This voltage is limited due to the voltage rating of the input capacitors.
GND	These terminals are the ground connections to the device. There are three different GND connections on the PCB. J2 should be used for the input supply, J4 should be used for the load, and J8 should be used for low power signal connections such as ENABLE.
VOUT	This terminal connects to the output voltage of the power supply and should be connected to the load.
ENABLE	This terminal connects to the enable pin of the device. This terminal can be left floating or driven externally. If driven externally, a voltage typically less than 1.2V will disable the device. The operating voltage for this pin should not exceed 5.5V. The absolute maximum voltage rating on this pin is 6V.
SS/TRK	This terminal provides access to the SS/TRK pin of the device. Connections to this terminal are not needed for most applications. The feedback pin of the device will track the voltage on the SS/TRK pin if it is driven with an external voltage source that is below the 0.8V reference. The voltage on this pin should not exceed 5.5V during normal operation. The absolute maximum voltage rating on this pin is 6V.
PGOOD	This terminal connects to the power good output of the device. There is an option to connect this pin to VOUT or VCC through a 10 k Ω pull-up resistor. The voltage on this pin should not exceed 5.5V during normal operation and has an absolute maximum voltage rating of 6V.
JP1	This terminal block selects the pull-up voltage for the PGOOD pin to be either VCC or VOUT. An external voltage source for PGOOD may be supplied by connecting to the center terminal. The voltage applied to PGOOD should not exceed 5.5V during normal operation and has an absolute maximum voltage rating of 6V.
SW	This terminal allows easy probing of the switch node. Do not apply any external voltage source to this pin.
TP1 (VOUT)	This is a oscilloscope probe connector point used to measure the output ripple and transient response. It is design to work with most Tektronix oscilloscope probes and is the recommended measurement point for evaluating AC performance.

4 Performance Characteristics

4.1 Efficiency Plots

Figure 1 shows the conversion efficiency versus output current for a 5V and 12V input voltage.

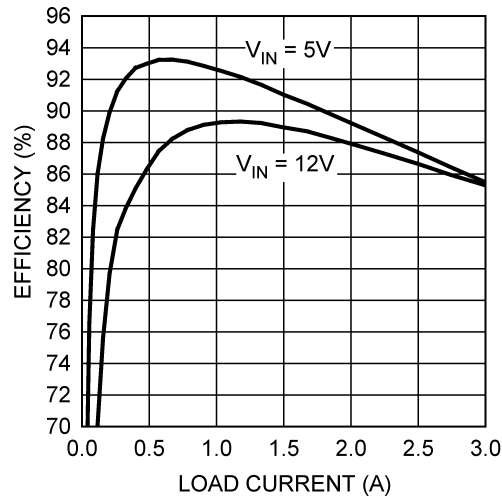

Figure 1. Conversion Efficiency Versus Output Current

4.2 Turn-On Waveform

When applying power to the LM20323 evaluation board a soft-start sequence occurs. Figure 2 shows the output voltage during a typical start-up sequence.

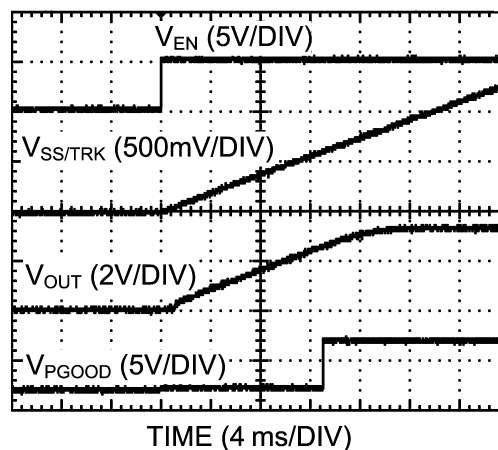
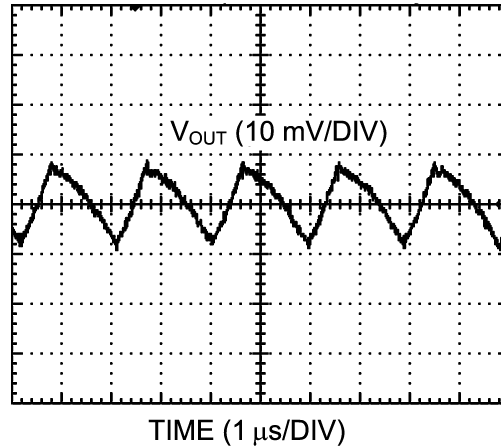

Figure 2. Output Voltage During a Typical Start-Up Sequence

4.3 Output Ripple Waveform

Figure 3 shows the output voltage ripple. This measurement was taken with the scope probe tip placed on the J3 load terminal and the scope probe ground "barrel" pushed against the J4 load terminal. The scope bandwidth is set to 20 MHz.



Bandwidth Limit = 20 MHz

Figure 3. Output Voltage Ripple

4.4 Output Transient Response

Figure 4 shows the output transient response during a 300mA to 3A transient.

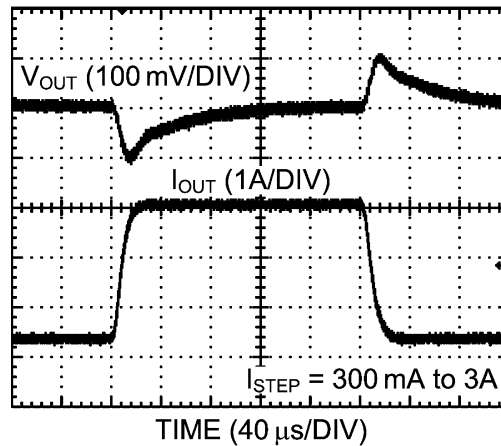

Figure 4. Output Transient Response

5 Bill of Materials (BOM)

The Bill of Materials is shown in [Table 2](#), including the manufacturer and part number.

Table 2. Bill of Materials (BOM)

QTY	DESIGNATOR	PART NUMBER	DESCRIPTION	VALUE
1	C1	GRM32ER61E226KE15	CAPACITOR, 1210 X5R CER, MURATA	22 μ F, 25V
2	C2, C3	GRM21BR61E475KA12L	CAPACITOR, 0805 X5R CER, MURATA	4.7 μ F, 25V
1	C5	GRM188R71A105KA61D	CAPACITOR, 0603 X7R CER, MURATA	1 μ F, 10V
2	C4, C6	C1608X7R1H104K	CAPACITOR, 0603 X7R CER, TDK	0.1 μ F, 50V
1	C7	C1608C0G1H100J	CAPACITOR, 0603 COG CER, TDK	10 pF, 50V
1	C8	C1608C0G1H102J	CAPACITOR, 0603 COG CER, TDK	1000 pF, 50V
1	C9	6TPB150MAZB	CAPACITOR, POSCAP B, SANYO	150 μ F, 6.3V
1	D1	CMMSH1-40-NST	DIODE, SCHOTTKY, CENTRAL SEMI	1A, 40V
1	L1	IHLP4040DZER5R6M01	INDUCTOR, VISHAY	5.6 μ H, 16A
2	R1, R6	CRCW06031002F	RESISTOR, 0603, VISHAY	10 k Ω
1	R7	CRCW06034992F	RESISTOR, 0603, VISHAY	49.9 k Ω
0	R2, R3	OPEN	-	-
1	R4	CRCW0603348RF	RESISTOR, 0603, VISHAY	348 Ω
1	R5	CRCW06033092F	RESISTOR, 0603, VISHAY	30.9 k Ω
1	U1	LM20323	SWITCHING REGULATOR, Texas Instruments	
4	J1 - J4	160-1026-02-01-00	TURRET TERMINAL, CAMBION	TERMINAL, TURRET
3	J6, J7, J9	5002	TERMINAL, SINGLE PIN, KEYSTONE	TESTPOINT, LOOP
1	J5	5000	TERMINAL, SINGLE PIN, KEYSTONE	TESTPOINT, LOOP
1	J8	5001	TERMINAL, SINGLE PIN, KEYSTONE	TESTPOINT, LOOP
1	TP1	131503100	TEKTRONIX SCOPE PROBE TESTPOINT	PROBE TESTPOINT

6 Component Selection

This section provides a walk-through of the design process of the LM20323 evaluation board. Unless otherwise indicated, all equations assume units of amps (A) for current, farads (F) for capacitance, henries (H) for inductance, and volts (V) for voltages.

6.1 Input Capacitors: C1, C2, C3

The required RMS current rating of the input capacitor for a buck regulator can be estimated by [Equation 1](#):

$$I_{CIN(RMS)} = I_{OUT} \sqrt{D(1-D)} \quad (1)$$

The variable D refers to the duty cycle, and can be approximated by:

$$D = \frac{V_{OUT}}{V_{IN}} \quad (2)$$

From this equation, it follows that the maximum $I_{CIN(RMS)}$ requirement will occur at a full 3A load current with the system operating at 50% duty cycle. Under this condition, the maximum $I_{CIN(RMS)}$ is given by:

$$I_{CIN(RMS)} = 3A \sqrt{0.5 \times 0.5} = 1.5A \quad (3)$$

Ceramic capacitors feature a very large I_{RMS} rating in a small footprint, making a ceramic capacitor ideal for this application. A two 4.7 μ F, X5R, 25V ceramic capacitor(C2, C3) from Murata are used to provide the necessary input capacitance for the evaluation board. An additional 22 μ F, X5R, 25V capacitor is used to provide additional input capacitance to counter cabling inductance to the input.

6.2 Inductor: L1

The value of the inductor was selected to allow the device to achieve a 12V to 3.3V conversion at 500kHz to provide a peak to peak ripple current 854mA, which is about 28.5% of the maximum output current. To have an optimized design, generally the peak to peak inductor ripple current should be kept to within 20% to 40% of the rated output current for a given input voltage, output voltage and operating frequency. The peak to peak inductor ripple current can be calculated by [Equation 4](#):

$$\Delta I_{P-P} = \frac{(V_{IN} - V_{OUT}) \times D}{L \times f_{SW}} \quad (4)$$

Once an inductance value is calculated, an actual inductor needs to be selected based on a trade-off between physical size, efficiency, and current carrying capability. For the LM20323 evaluation board, a Vishay IHLP4040DZER5R6M01 inductor offers a good balance between efficiency (18 mΩ DCR), size, and saturation current rating (16A I_{SAT} rating).

6.3 Output Capacitor: C9

The value of the output capacitor in a buck regulator influences the voltage ripple that will be present on the output voltage, as well as the large signal output voltage response to a load transient. Given the peak-to-peak inductor current ripple (ΔI_{P-P}) the output voltage ripple can be approximated by [Equation 5](#):

$$\Delta V_{OUT} = \Delta I_{P-P} \times \left[R_{ESR} + \frac{1}{8 \times f_{SW} \times C_{OUT}} \right] \quad (5)$$

The variable R_{ESR} above refers to the ESR of the output capacitor. As can be seen in [Equation 5](#), the ripple voltage on the output can be divided into two parts, one of which is attributed to the AC ripple current flowing through the ESR of the output capacitor and another due to the AC ripple current actually charging and discharging the output capacitor. The output capacitor also has an effect on the amount of droop that is seen on the output voltage in response to a load transient event.

For the evaluation board, a Sanyo 150 μF POSCAP output capacitor was selected to provide good transient and DC performance in a relatively small package. From the technical specifications of this capacitor, the ESR is roughly 35 mΩ, and RMS ripple current rating is 1.4A. With these values, the worst case peak to peak voltage ripple on the output when operating from a 12V input can be calculated to be 31 mV.

6.4 Soft-Start Capacitor: C6

A soft-start capacitor can be used to control the startup time of the LM20323 voltage regulator. The startup time of the regulator when using a soft-start capacitor can be estimated by [Equation 6](#):

$$t_{SS} = \frac{0.8V \times C6}{I_{SS}} \quad (6)$$

For the LM20323, I_{SS} is nominally 5 μA. For the evaluation board, the soft-start time has been designed to be roughly 15 ms, resulting in a C_{SS} capacitor value of 100 nF.

6.5 VCC Bypass: C5

The capacitor C5 is used to bypass the internal 4.5V sub-regulator. A value of 1 μF is sufficient for most applications.

6.6 Boot Capacitor: C4

C4 is the boot capacitor that is used to provide the charge needed to drive the high-side FET. An optimal value for this capacitor is 0.1 μF.

6.7 Compensation Capacitor: C8

The capacitor C8 is used to set the crossover frequency of the LM20323 control loop. Since this board was optimized to be stable over the full input and output voltage range, the value of C8 was selected to be 1 nF. Once the operating conditions for the device are known, the transient response can be optimized by reducing the value of C8 and calculating the value for R7 as outlined in [Section 6.8](#).

6.8 Compensation Resistor: R7

Once the value of C8 is known, resistor R7 is used to place a zero in the control loop to cancel the output filter pole. This resistor can be sized according to [Equation 7](#):

$$R7 = \left[\frac{C8}{C9} \times \left[\frac{I_{OUT}}{V_{OUT}} + \frac{2 \times D}{f_{SW} \times L1} \right] \right]^{-1} \quad (7)$$

For stability purposes the device should be compensated for the maximum output current expected in the application.

6.9 Optional Compensation Capacitor: C7

A second compensation capacitor C7 can be used in some designs to improve noise immunity for low duty cycle conversions, as well as, provide a high frequency pole, useful for cancelling a possible zero introduced by the ESR of the output capacitor. For the LM20323 evaluation board, a 10pF capacitor is populated for C7. Higher value capacitors can be used to improve low duty cycle performance at the expense of phase margin.

6.10 Feedback Resistors: R4, R5, and R6

The resistors labeled R5 and R6 create a voltage divider from V_{OUT} to the feedback pin that is used to set the output of the voltage regulator. Nominally, the output of the LM20323 evaluation board is set to 3.3V, giving resistor values of $R5 = 30.9 \text{ k}\Omega$ and $R6 = 10 \text{ k}\Omega$. If a different output voltage is required, the value of R5 can be adjusted according to [Equation 8](#):

$$R5 = \left(\frac{V_{OUT}}{0.8} - 1 \right) \times R6 \quad (8)$$

R6 does not need to be changed from its value of 10 kΩ. Resistor R4 has a value of 348Ω and is provided as an injection point for loop stability measurements, as well as, a way to further tweak the output voltage accuracy to account for resistor tolerance values differing from ideal calculated values.

6.11 Programmable UVLO: R2 and R3

The resistors labeled R2 and R3 create a voltage divider from V_{IN} to the enable pin that can be used to set the turn-on threshold or UVLO of the voltage regulator. To allow evaluation of the device down to 4.5V these components are not installed. To change the turn-on threshold of the device a 10 kΩ resistor is recommended for R3 and the value of R2 can be calculated using [Equation 9](#):

$$R2 = \left(\frac{V_{TO}}{1.25} - 1 \right) \times R3 \quad (9)$$

7 PCB Layout

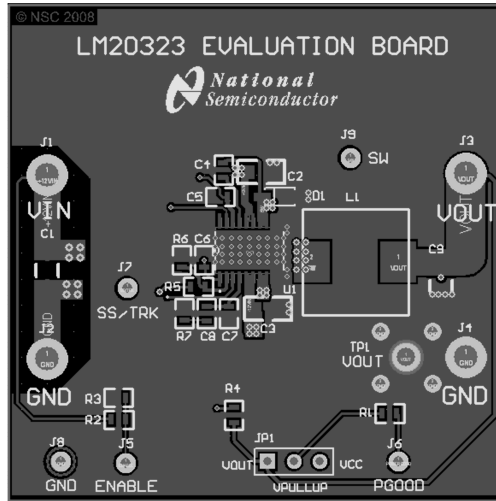

Figure 5. Top Layer

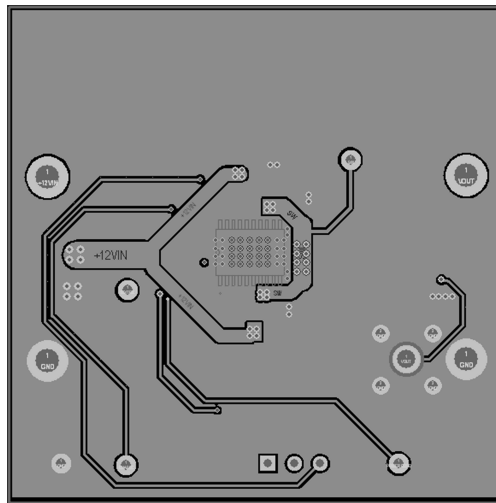

Figure 6. Mid Layer1

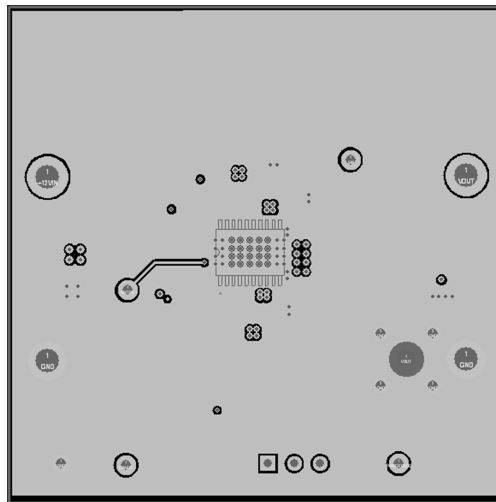

Figure 7. Mid Layer2

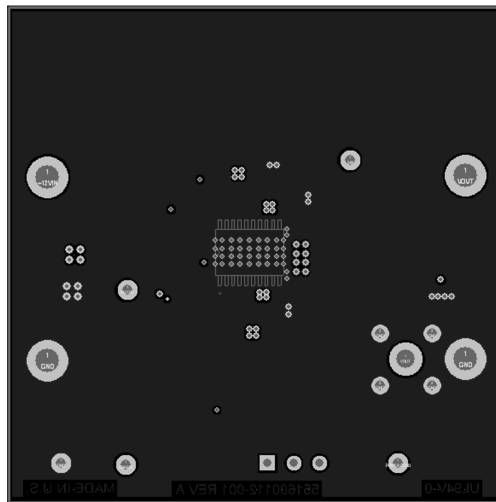

Figure 8. Bottom Layer

IMPORTANT NOTICE

Texas Instruments Incorporated and its subsidiaries (TI) reserve the right to make corrections, enhancements, improvements and other changes to its semiconductor products and services per JESD46, latest issue, and to discontinue any product or service per JESD48, latest issue. Buyers should obtain the latest relevant information before placing orders and should verify that such information is current and complete. All semiconductor products (also referred to herein as "components") are sold subject to TI's terms and conditions of sale supplied at the time of order acknowledgment.

TI warrants performance of its components to the specifications applicable at the time of sale, in accordance with the warranty in TI's terms and conditions of sale of semiconductor products. Testing and other quality control techniques are used to the extent TI deems necessary to support this warranty. Except where mandated by applicable law, testing of all parameters of each component is not necessarily performed.

TI assumes no liability for applications assistance or the design of Buyers' products. Buyers are responsible for their products and applications using TI components. To minimize the risks associated with Buyers' products and applications, Buyers should provide adequate design and operating safeguards.

TI does not warrant or represent that any license, either express or implied, is granted under any patent right, copyright, mask work right, or other intellectual property right relating to any combination, machine, or process in which TI components or services are used. Information published by TI regarding third-party products or services does not constitute a license to use such products or services or a warranty or endorsement thereof. Use of such information may require a license from a third party under the patents or other intellectual property of the third party, or a license from TI under the patents or other intellectual property of TI.

Reproduction of significant portions of TI information in TI data books or data sheets is permissible only if reproduction is without alteration and is accompanied by all associated warranties, conditions, limitations, and notices. TI is not responsible or liable for such altered documentation. Information of third parties may be subject to additional restrictions.

Resale of TI components or services with statements different from or beyond the parameters stated by TI for that component or service voids all express and any implied warranties for the associated TI component or service and is an unfair and deceptive business practice. TI is not responsible or liable for any such statements.

Buyer acknowledges and agrees that it is solely responsible for compliance with all legal, regulatory and safety-related requirements concerning its products, and any use of TI components in its applications, notwithstanding any applications-related information or support that may be provided by TI. Buyer represents and agrees that it has all the necessary expertise to create and implement safeguards which anticipate dangerous consequences of failures, monitor failures and their consequences, lessen the likelihood of failures that might cause harm and take appropriate remedial actions. Buyer will fully indemnify TI and its representatives against any damages arising out of the use of any TI components in safety-critical applications.

In some cases, TI components may be promoted specifically to facilitate safety-related applications. With such components, TI's goal is to help enable customers to design and create their own end-product solutions that meet applicable functional safety standards and requirements. Nonetheless, such components are subject to these terms.

No TI components are authorized for use in FDA Class III (or similar life-critical medical equipment) unless authorized officers of the parties have executed a special agreement specifically governing such use.

Only those TI components which TI has specifically designated as military grade or "enhanced plastic" are designed and intended for use in military/aerospace applications or environments. Buyer acknowledges and agrees that any military or aerospace use of TI components which have **not** been so designated is solely at the Buyer's risk, and that Buyer is solely responsible for compliance with all legal and regulatory requirements in connection with such use.

TI has specifically designated certain components as meeting ISO/TS16949 requirements, mainly for automotive use. In any case of use of non-designated products, TI will not be responsible for any failure to meet ISO/TS16949.

Products

Audio	www.ti.com/audio
Amplifiers	amplifier.ti.com
Data Converters	dataconverter.ti.com
DLP® Products	www.dlp.com
DSP	dsp.ti.com
Clocks and Timers	www.ti.com/clocks
Interface	interface.ti.com
Logic	logic.ti.com
Power Mgmt	power.ti.com
Microcontrollers	microcontroller.ti.com
RFID	www.ti-rfid.com
OMAP Applications Processors	www.ti.com/omap
Wireless Connectivity	www.ti.com/wirelessconnectivity

Applications

Automotive and Transportation	www.ti.com/automotive
Communications and Telecom	www.ti.com/communications
Computers and Peripherals	www.ti.com/computers
Consumer Electronics	www.ti.com/consumer-apps
Energy and Lighting	www.ti.com/energy
Industrial	www.ti.com/industrial
Medical	www.ti.com/medical
Security	www.ti.com/security
Space, Avionics and Defense	www.ti.com/space-avionics-defense
Video and Imaging	www.ti.com/video

TI E2E Community

e2e.ti.com