



ABSTRACT

The LM5156HEVM-FLY evaluation module showcases the features and performance of the LM51561-HTSSOP as wide input non-synchronous flyback controller. The standard configuration is designed to provide a regulate output of 5 V at 4 A from an input of 18 V to 36 V, switching at 250 kHz. This evaluation module is designed for ease of configuration, enabling the user to evaluate many different applications on the same module. The PCB is two layers with components populated only on one side. Functionality includes programmable slope compensation, adjustable soft-start, programmable cycle-by-cycle current limit, hiccup mode short-circuit protection, and programmable line undervoltage lockout

Table of Contents

1 Introduction	3
1.1 Features.....	3
1.2 Applications Schematic.....	3
1.3 Electrical Parameters.....	4
2 EVM Setup	5
2.1 EVM Connectors and Test Points.....	5
3 Testing Procedures	6
3.1 Testing Equipment	6
3.2 Precautions.....	6
4 Test Results	7
4.1 Efficiency Curve.....	7
4.2 Load Regulation.....	7
4.3 Thermal Performance	8
4.4 Steady State Waveforms.....	8
4.5 Start-up Waveforms.....	10
4.6 Load Transient Waveforms.....	11
4.7 Load Short-Circuit.....	12
4.8 AC Loop Response.....	14
5 PCB Layout	15
6 Schematics	16
7 Bill of Materials	17

List of Figures

Figure 1-1. Application Circuit.....	3
Figure 2-1. Test Setup.....	5
Figure 4-1. Efficiency vs ILOAD	7
Figure 4-2. Load Regulation	7
Figure 4-3. Thermal Performance: VSUPPLY = 36V, ILOAD = 4A, No forced air cooling.....	8
Figure 4-4. Steady State, VSUPPLY = 18V, ILOAD = 4A	8
Figure 4-5. Steady State, VSUPPLY = 24V, ILOAD = 4A.....	9
Figure 4-6. Steady State, VSUPPLY = 36V, ILOAD = 4A.....	9
Figure 4-7. Start-Up, VSUPPLY = 18 V, ILOAD = 0 A.....	10
Figure 4-8. Start-Up, VSUPPLY = 18 V, ILOAD = 4 A.....	10
Figure 4-9. Start-Up, VSUPPLY = 24 V, ILOAD = 0 A.....	10
Figure 4-10. Start-Up, VSUPPLY = 24 V, ILOAD = 4 A.....	10
Figure 4-11. Start-Up, VSUPPLY = 36 V, ILOAD = 0 A.....	10
Figure 4-12. Start-Up, VSUPPLY = 36 V, ILOAD = 4 A.....	10

Figure 4-13. Load Transient, VSUPPLY = 18 V, ILOAD = 2 A to 4 A.....	11
Figure 4-14. Load Transient, VSUPPLY = 24 V, ILOAD = 2 A to 4 A.....	11
Figure 4-15. Load Transient, VSUPPLY = 36 V, ILOAD = 2 A to 4 A.....	12
Figure 4-16. Short-Circuit Protection.....	12
Figure 4-17. Short-Circuit Recovery: VSUPPLY = 36 V.....	13
Figure 4-18. Control Loop Response VSUPPLY = 18 V, ILOAD = 4 A.....	14
Figure 4-19. Control Loop Response VSUPPLY = 24 V, ILOAD = 4 A.....	14
Figure 4-20. Control Loop Response VSUPPLY = 36 V, ILOAD = 4 A.....	15
Figure 5-1. Top Silkscreen.....	15
Figure 5-2. Top Layer.....	15
Figure 5-3. Bottom Layer.....	15
Figure 5-4. Bottom Silkscreen.....	15
Figure 6-1. LM5156HEVM-FLY Schematic.....	16

List of Tables

Table 1-1. Electrical Performance Standard Configuration.....	4
Table 2-1. Test Point Description.....	5
Table 7-1. LM5156HEVM-FLY Bill of Materials.....	17

Trademarks

All other trademarks are the property of their respective owners.

1 Introduction

1.1 Features

The LM5156HEVM-FLY supports the following features and performance capabilities:

- Tightly regulated output voltage of 5 V
- High conversion efficiency of > 86% at full load.
- Hiccup mode short-circuit protection
- User adjustable secondary side soft-start time
- 10-V auxiliary winding to power VCC pin
- 250-kHz switching frequency
- 2-layer PCB with components populated on 1 side

1.2 Applications Schematic

The LM5156HEVM-FLY is capable of multiple configurations. [Figure 1-1](#) shows the standard configuration of the LM5156HEVM-FLY for which the parameters in [Table 1-1](#) are valid.

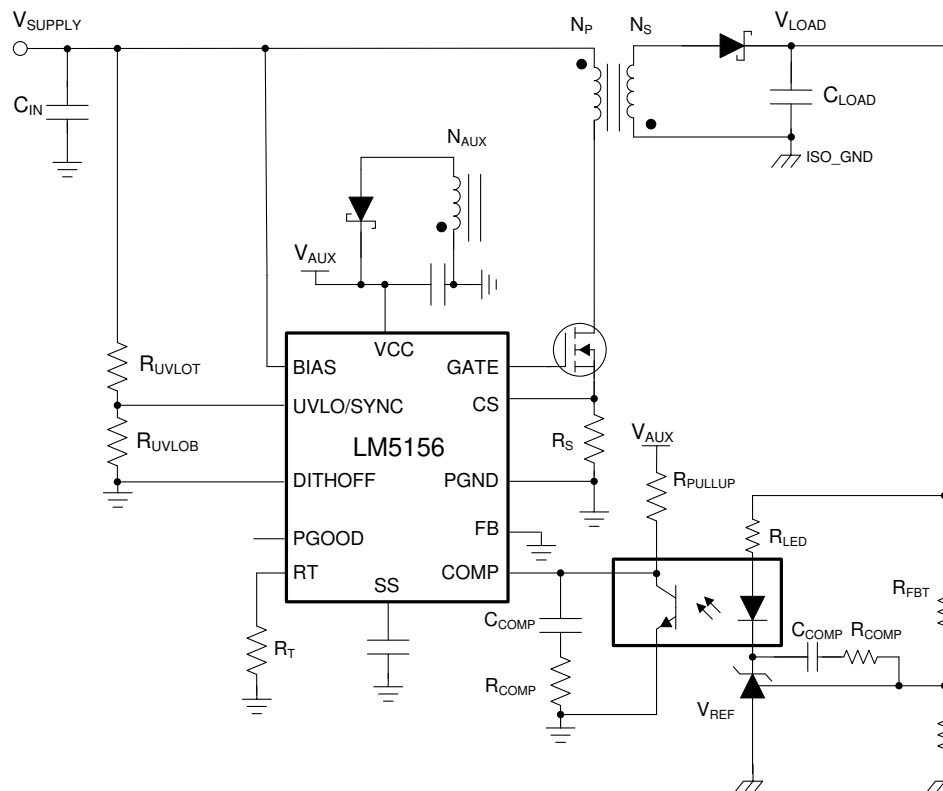

Figure 1-1. Application Circuit

1.3 Electrical Parameters

Table 1-1. Electrical Performance Standard Configuration

Parameter	Test Conditions	MIN	TYP	MAX	UNIT
INPUT CHARACTERISTICS					
Input voltage Range V_{IN}	Operation	18	24	36	V
Input voltage turn on $V_{IN(ON)}$	Adjusted by the UVLO/SYNC resistors		17		V
Input voltage turn off $V_{IN(OFF)}$			16.5		V
OUTPUT CHARACTERISTICS					
Output Voltage V_{OUT}			5		V
Maximum Output Current I_{OUT}			4		A
SYSTEM CHARACTERISTICS					
Switching frequency			250		kHz
Peak efficiency	$V_{IN} = 18V, I_{OUT} = 1.8A$		86.5		%
Junction Temperature, T_J		-40		150	C
Transformer Specifications (Würth 750319733)					
Primary Inductance			21		μH
Turns Ratio	(3-5):(2-1)		1:1		
	(3-5):(6:10) tie (6+7,9+10)		2:1		
Saturation Current	20% inductance reduction		6.2		A
Leakage Inductance			150	300	nH

2 EVM Setup

Figure 2-1 shows the correct equipment connections and measurement points to recreate the recorded values in the *Test Results* section.

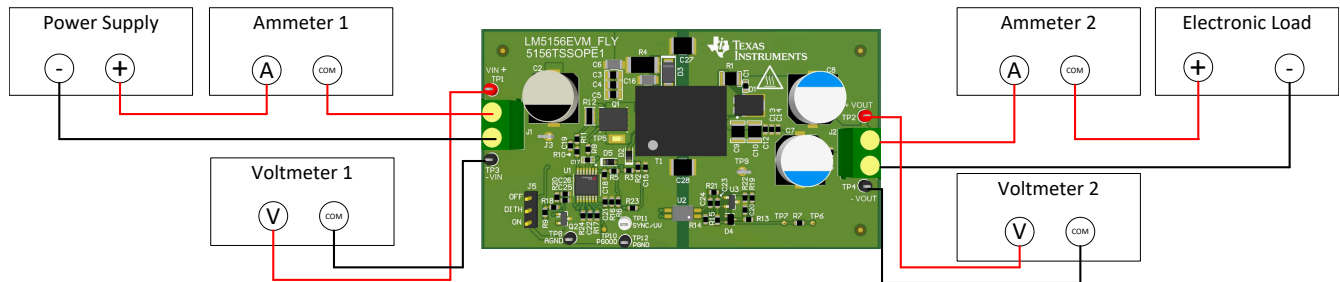

Figure 2-1. Test Setup

2.1 EVM Connectors and Test Points

Table 2-1 indicates the available test points and configuration jumpers.

Table 2-1. Test Point Description

Jumper	Name	Description
TP1	VIN	Positive input voltage sense connection
TP2	VOUT+	Positive output voltage sense connection
TP3	PGND	Negative input voltage sense connection
TP4	ISO_GND	Negative isolated output voltage sense connection
TP5	SW	Probe point for the switch node of the LM5155 flyback circuit
TP6	VOUT+	Loop response positive injection point
TP7	VOUT-	Loop response negative injection point
TP8	AGND	Analog ground connection point
TP9	ISO_GND	Isolated ground connection point
J1	-	Input power connections
J2	-	Output power connections
J3	PGND	Power ground connection point
J4	PGOOD (pin 1)	Probe voltage on the PGOOD pin of the LM5155
	COMP (pin 2)	Probe voltage on the COMP pin of the LM5155
	SS (pin 3)	Probe voltage on the SS pin of the LM5155
	VAUX (pin 4)	Auxiliary winding voltage
	PGND (pin 5)	Power ground connection
J5	DITHOFF	Placing jumper between pin 1 and pin 2 disables frequency dithering. Placing a jumper between pin 2 and pin 3 enabled frequency dithering

3 Testing Procedures

3.1 Testing Equipment

Power Supply: The input voltage source (VIN) should be a variable supply capable of 0 V to 36 V and source at least 5 A.

Multimeters:

- **Voltmeter 1:** Input voltage, connect from VIN to PGND
- **Voltmeter 2:** Output voltage, connect from VOUT to ISO_GND
- **Ammeter 1:** Input current, must be able to handle 5 A. Shunt resistor can be used as needed.
- **Ammeter 2:** Output current, must be able to handle 5 A. Shunt resistor can be used as needed.

Electronic Load: The load should be constant resistance (CR) or constant current (CC) capable. It should safely handle 4 A at 5 V.

Oscilloscope: 20-MHz bandwidth and AC coupling. Measure the output voltage ripple directly across an output capacitor with a short ground lead. It is not recommended to use a long-leaded ground connection due to the possibility of noise being coupled into the signal. To measure other waveforms, adjust the oscilloscope as needed.

3.2 Precautions



CAUTION

Prolonged operation with low input at full power will cause heating of the diode (D1).
Board surface is hot. Do not touch. Contact may cause burns.

4 Test Results

Section 4.1 through Section 4.8 present the typical performance of the LM5156HEVM-FLY according to the bill of materials and the configuration described in Section 7. Based on measurement techniques and environmental variables measurements, might differ slightly than the data presented

4.1 Efficiency Curve

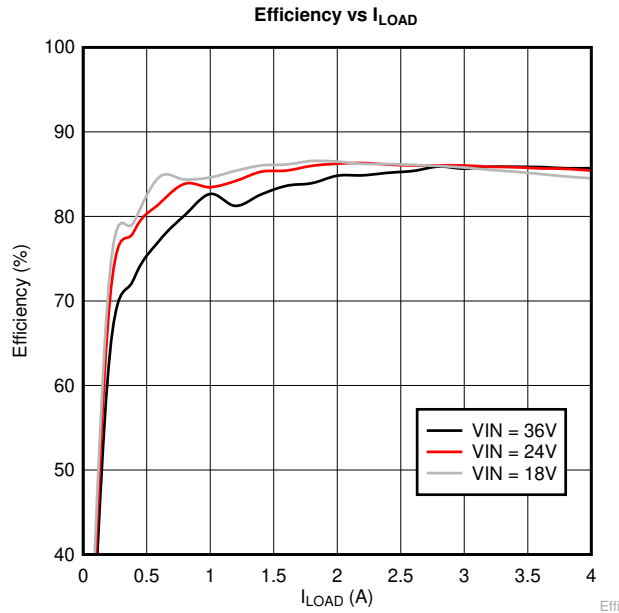

Figure 4-1. Efficiency vs I_LOAD

4.2 Load Regulation

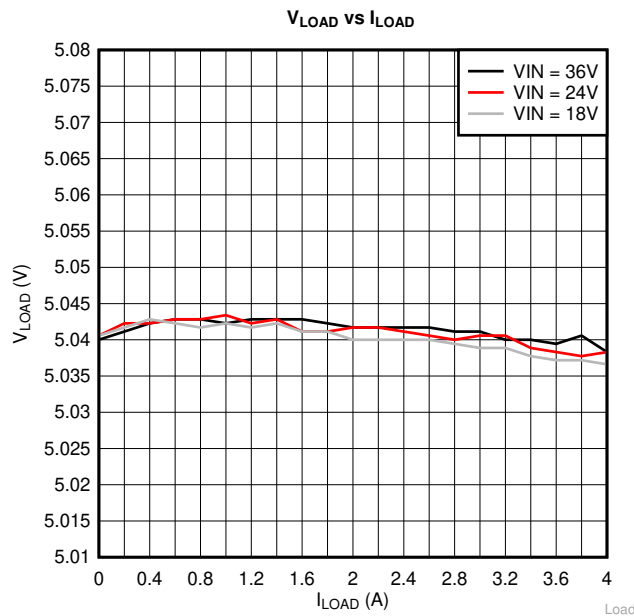

Figure 4-2. Load Regulation

4.3 Thermal Performance

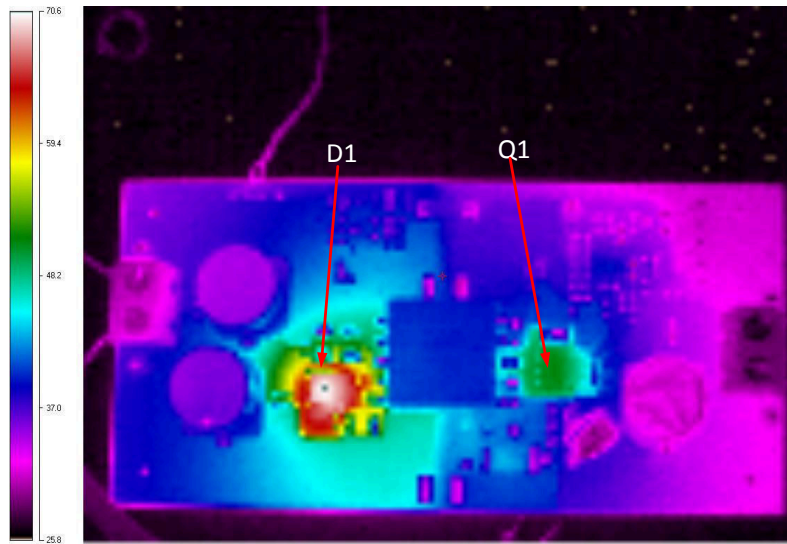

Figure 4-3. Thermal Performance: $V_{SUPPLY} = 36V$, $I_{LOAD} = 4A$, No forced air cooling

4.4 Steady State Waveforms

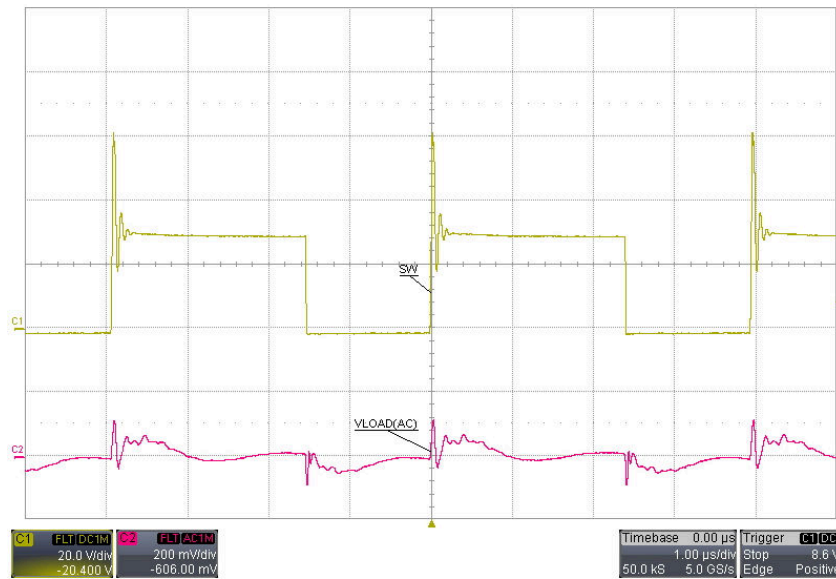

Figure 4-4. Steady State, $V_{SUPPLY} = 18V$, $I_{LOAD} = 4A$

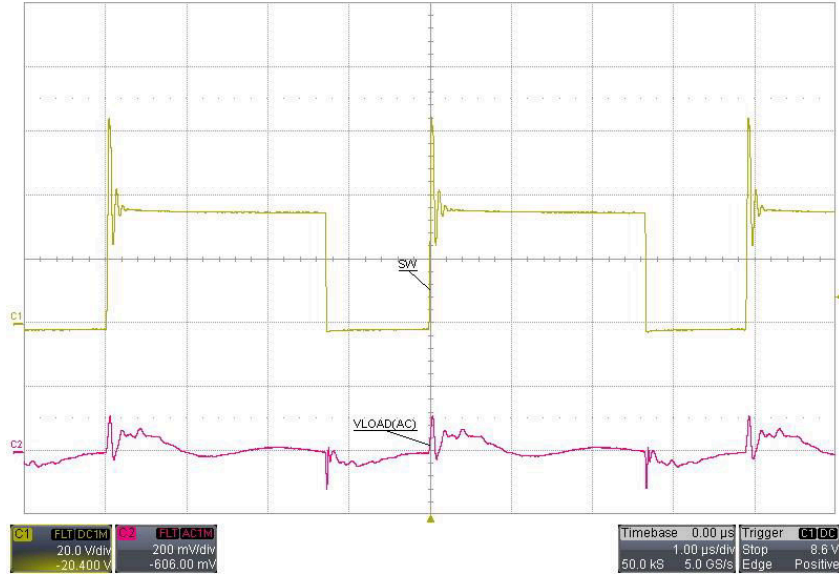

Figure 4-5. Steady State, $V_{\text{SUPPLY}} = 24\text{V}$, $I_{\text{LOAD}} = 4\text{A}$

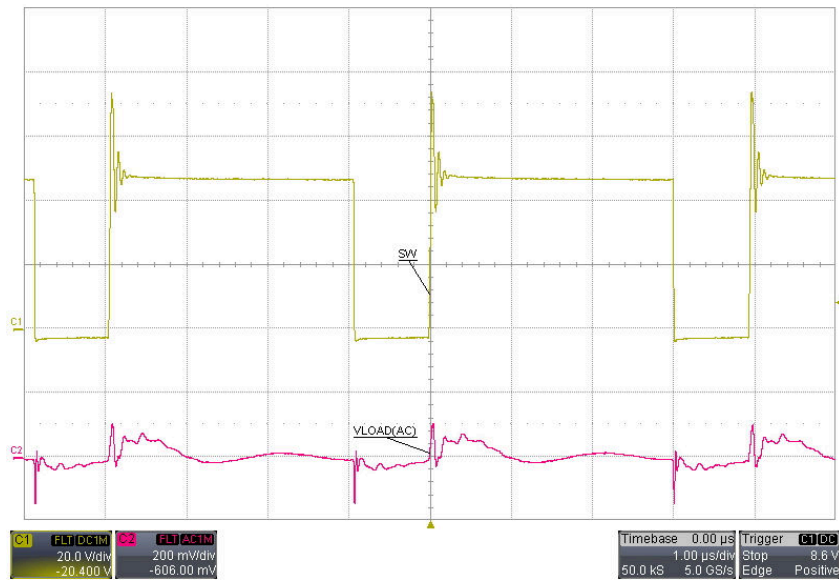

Figure 4-6. Steady State, $V_{\text{SUPPLY}} = 36\text{V}$, $I_{\text{LOAD}} = 4\text{A}$

4.5 Start-up Waveforms

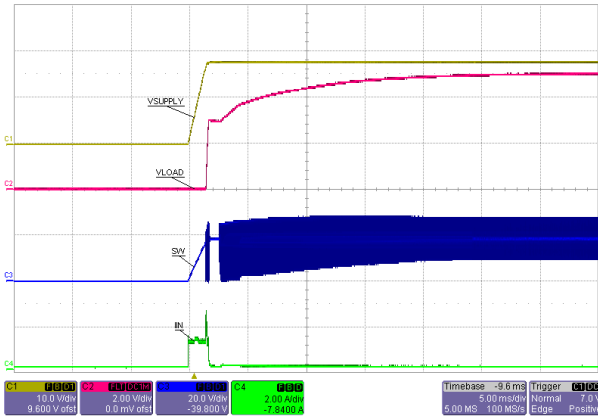

Figure 4-7. Start-Up, $V_{SUPPLY} = 18\text{ V}$, $I_{LOAD} = 0\text{ A}$

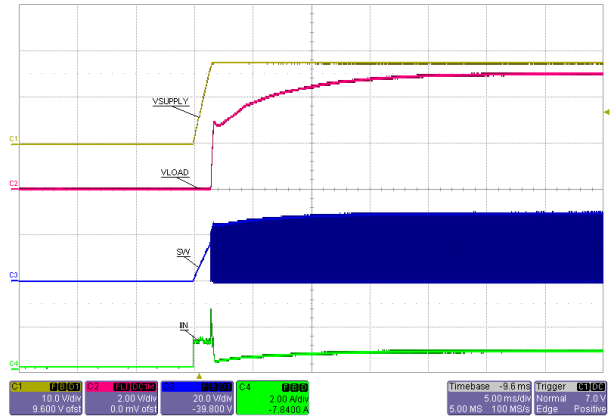

Figure 4-8. Start-Up, $V_{SUPPLY} = 18\text{ V}$, $I_{LOAD} = 4\text{ A}$

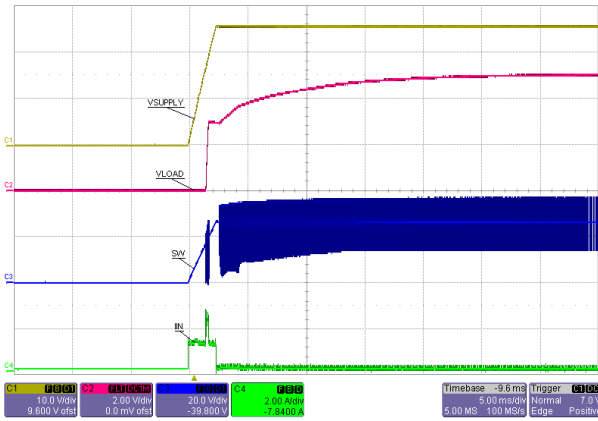

Figure 4-9. Start-Up, $V_{SUPPLY} = 24\text{ V}$, $I_{LOAD} = 0\text{ A}$

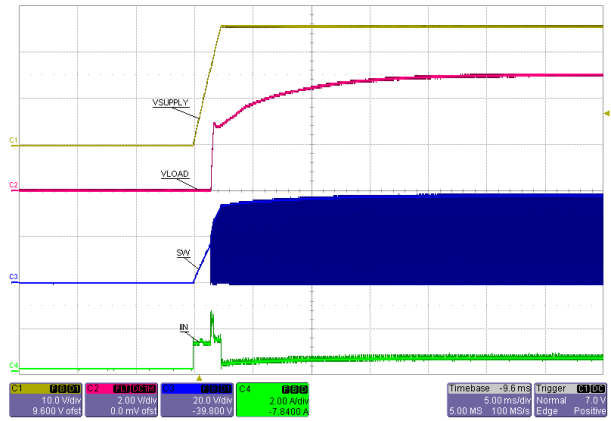

Figure 4-10. Start-Up, $V_{SUPPLY} = 24\text{ V}$, $I_{LOAD} = 4\text{ A}$

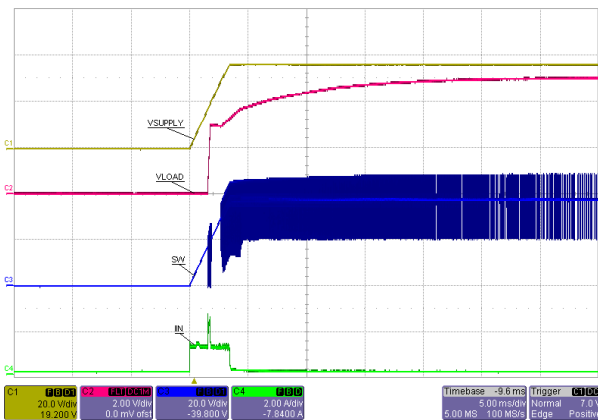

Figure 4-11. Start-Up, $V_{SUPPLY} = 36\text{ V}$, $I_{LOAD} = 0\text{ A}$

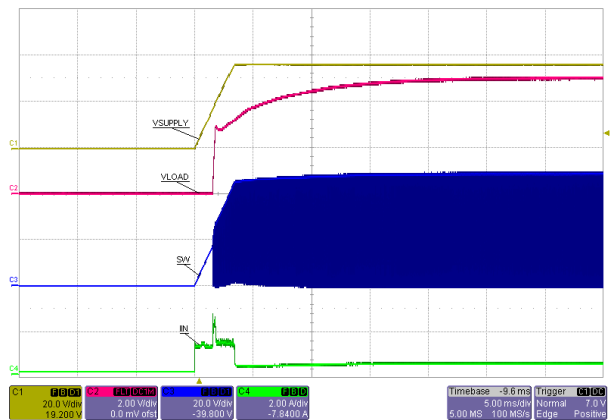

Figure 4-12. Start-Up, $V_{SUPPLY} = 36\text{ V}$, $I_{LOAD} = 4\text{ A}$

4.6 Load Transient Waveforms

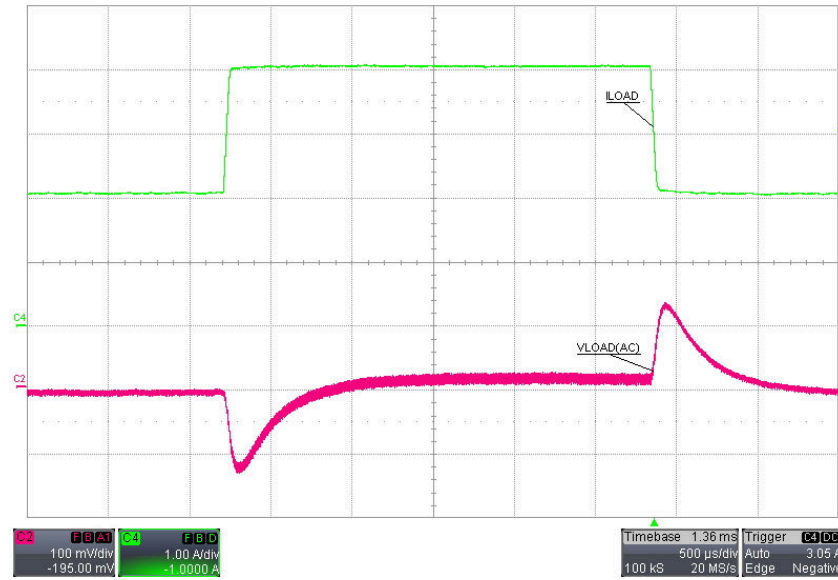

Figure 4-13. Load Transient, $V_{SUPPLY} = 18\text{ V}$, $I_{LOAD} = 2\text{ A to }4\text{ A}$

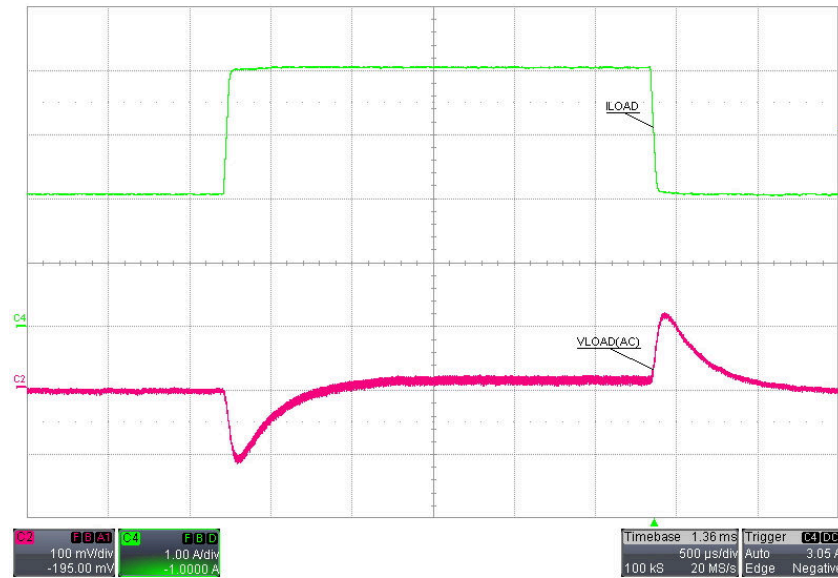

Figure 4-14. Load Transient, $V_{SUPPLY} = 24\text{ V}$, $I_{LOAD} = 2\text{ A to }4\text{ A}$



Figure 4-15. Load Transient, $V_{SUPPLY} = 36\text{ V}$, $I_{LOAD} = 2\text{ A to }4\text{ A}$

4.7 Load Short-Circuit

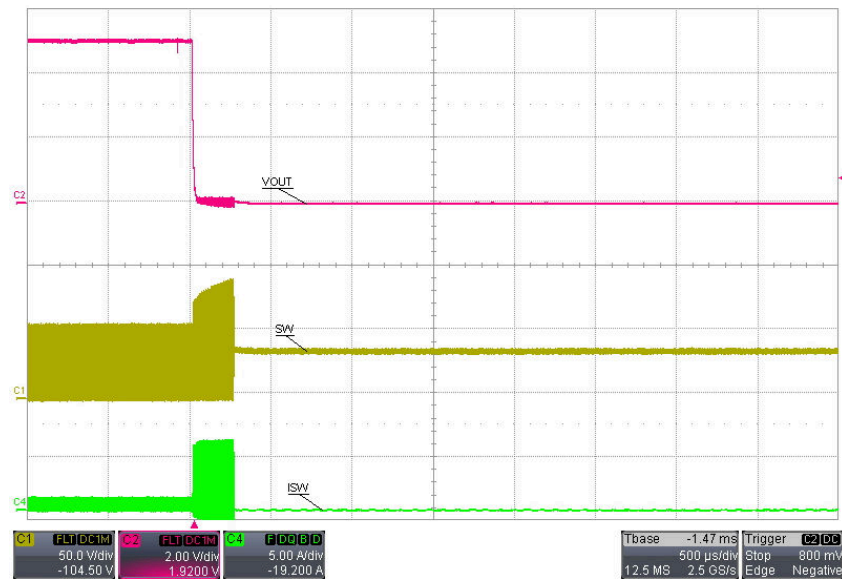

Figure 4-16. Short-Circuit Protection

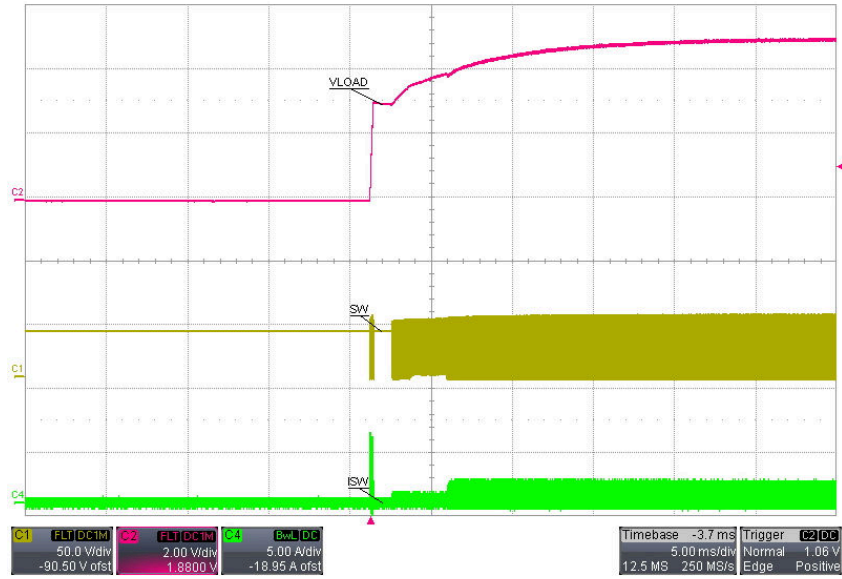

Figure 4-17. Short-Circuit Recovery: $V_{SUPPLY} = 36\text{ V}$

4.8 AC Loop Response

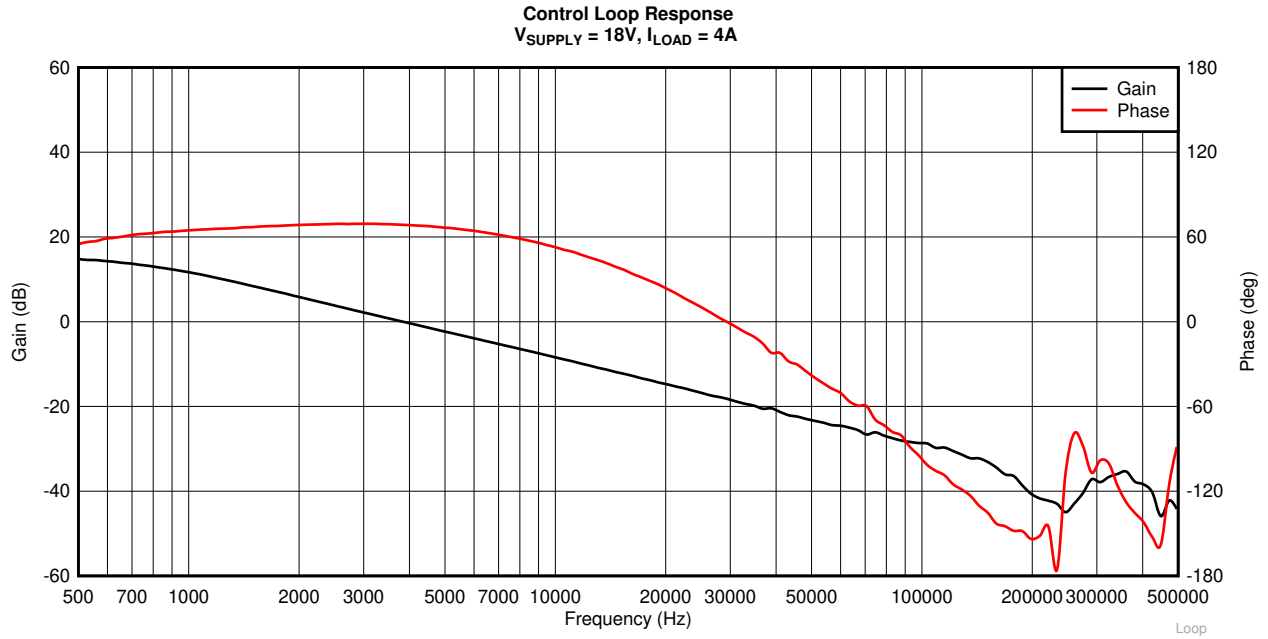

Figure 4-18. Control Loop Response $V_{\text{SUPPLY}} = 18\text{ V}, I_{\text{LOAD}} = 4\text{ A}$

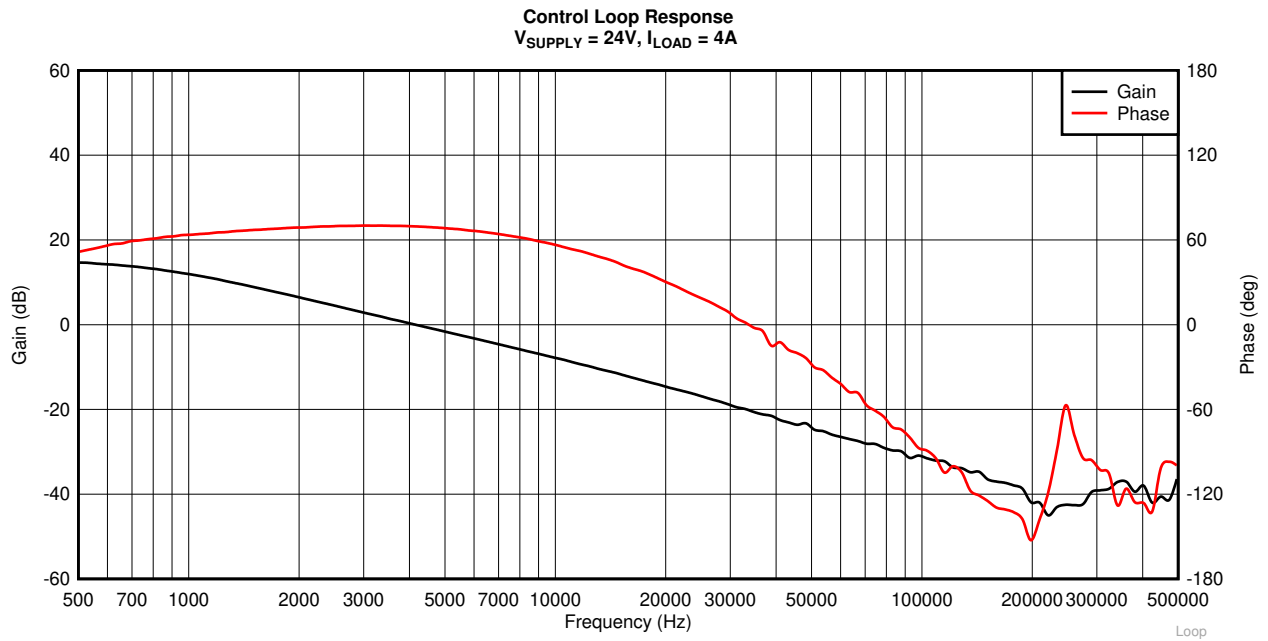

Figure 4-19. Control Loop Response $V_{\text{SUPPLY}} = 24\text{ V}, I_{\text{LOAD}} = 4\text{ A}$

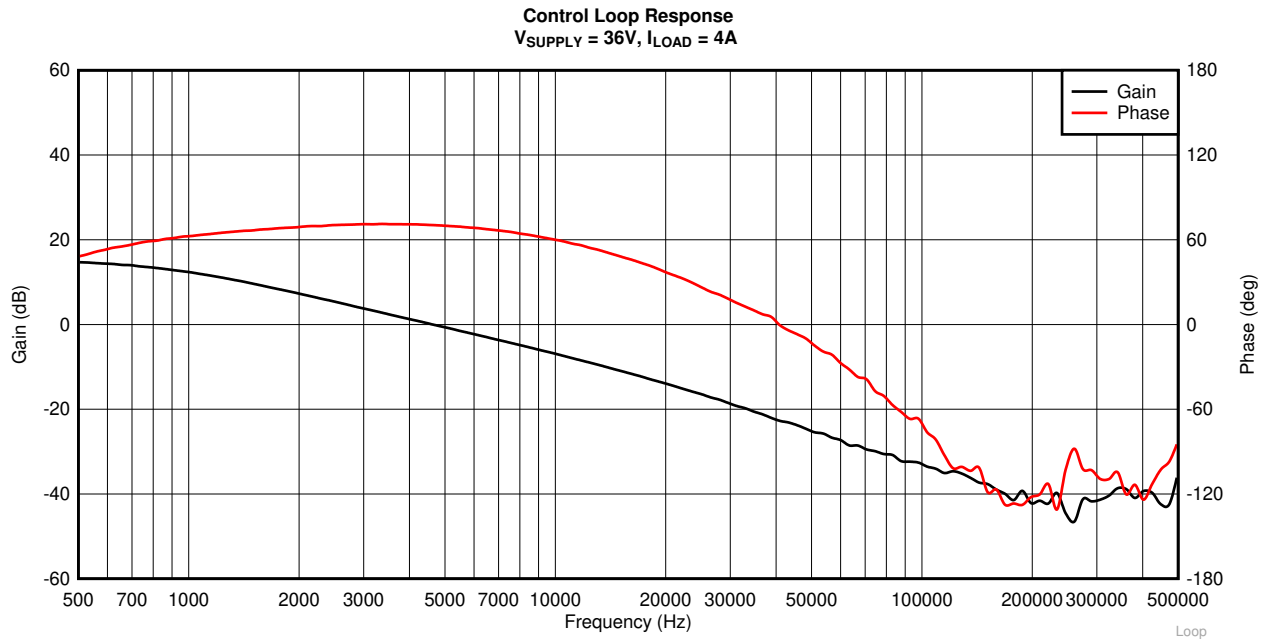

Figure 4-20. Control Loop Response $V_{SUPPLY} = 36V, I_{LOAD} = 4A$

5 PCB Layout

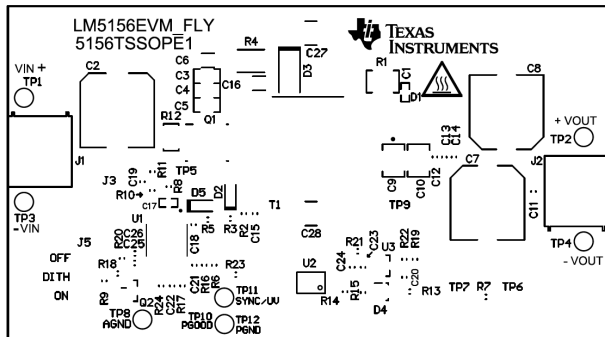

Figure 5-1. Top Silkscreen

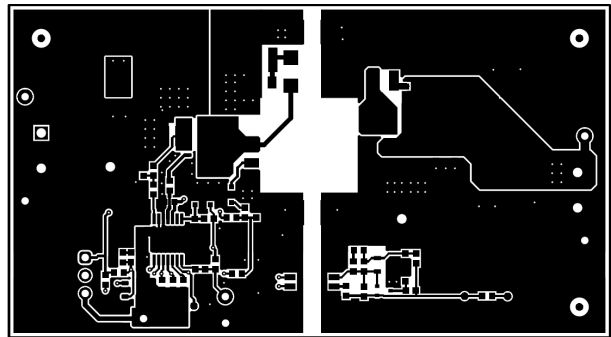

Figure 5-2. Top Layer

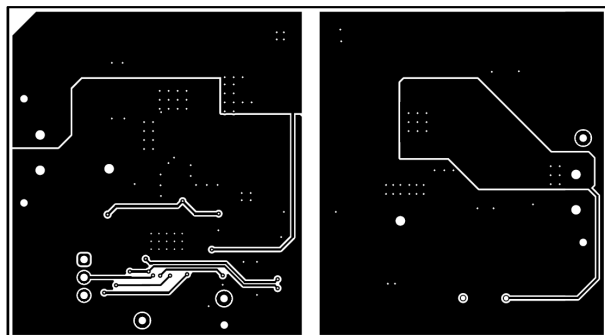

Figure 5-3. Bottom Layer

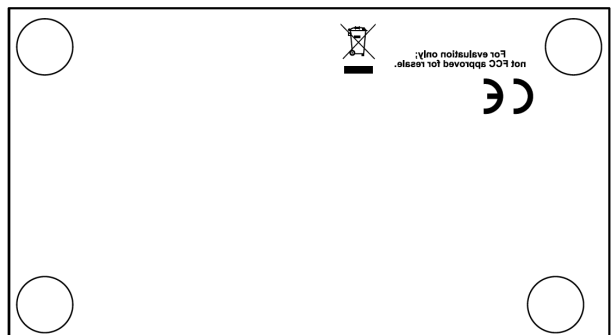

Figure 5-4. Bottom Silkscreen

6 Schematics

Figure 6-1 illustrates the EVM schematic.

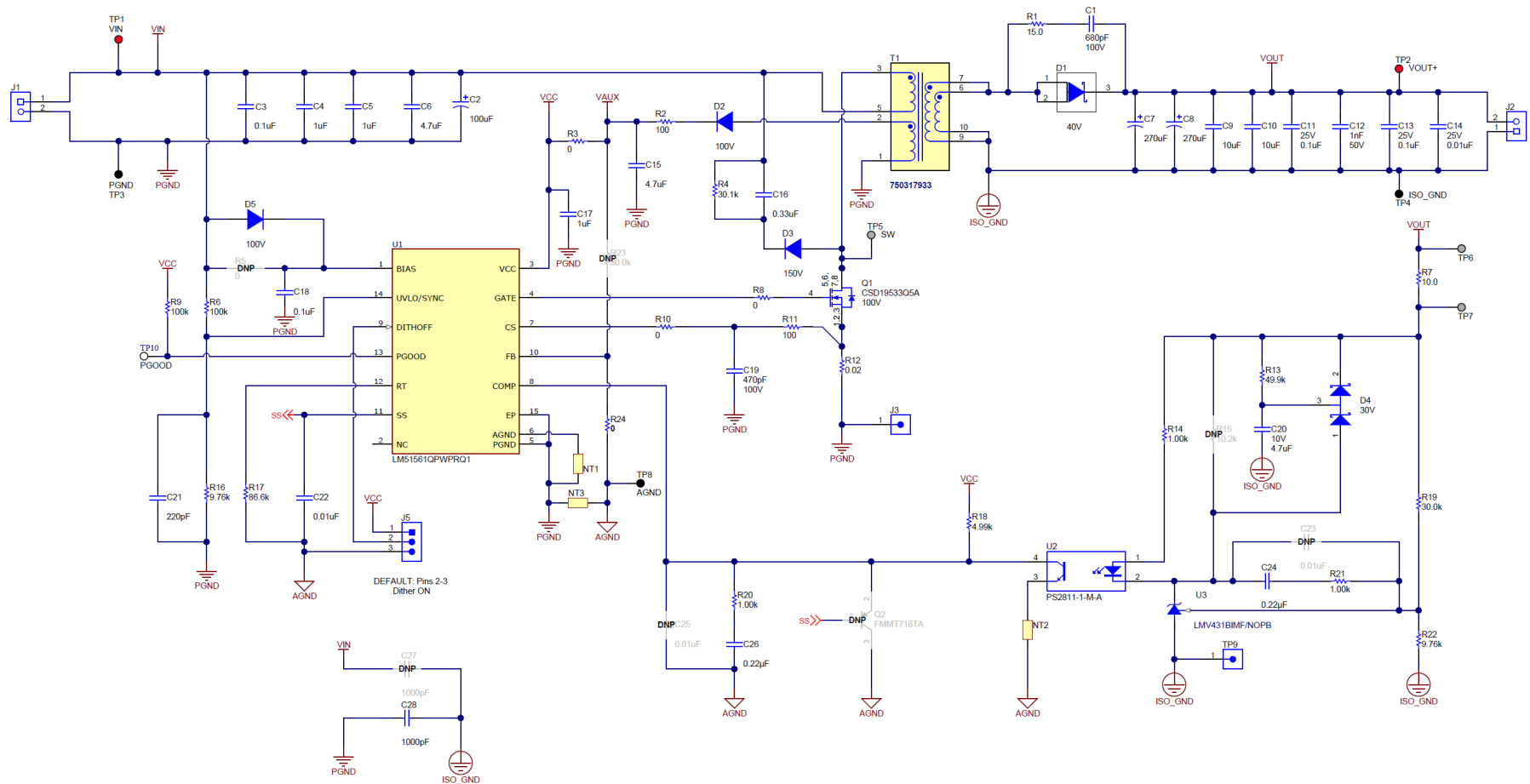

Figure 6-1. LM5156HEVM-FLY Schematic

7 Bill of Materials

Table 7-1 lists the EVM bill of materials.

Table 7-1. LM5156HEVM-FLY Bill of Materials

Designator	QTY	Value	Description	Package Reference	Part Number	Manufacturer
C1	1	680pF	CAP, CERM, 680 pF, 100 V, ±10%, X7R, 0603	0603	GRM188R72A681KA01D	MuRata
C2	1	100uF	CAP, Polymer Hybrid, 100 uF, 50 V, ±20%, 28 ohm, 10x10 SMD	10x10	EEHZC1H101P	Panasonic
C3	1	0.1uF	CAP, CERM, 0.1 uF, 50 V, ±20%, X7R, 0805	0805	08055C104MAT2A	AVX
C4, C5	2	1uF	CAP, CERM, 1 uF, 50 V, ±10%, X7R, 0805	0805	08055C105KAT2A	AVX
C6	1	4.7uF	CAP, CERM, 4.7 uF, 50 V, ±10%, X7R, 1206	1206	C3216X7R1H475K160AC	TDK
C7, C8	2	270uF	CAP, Aluminum Polymer, 270 uF, 25 V, ±20%, 0.027 ohm, D10xL12.7mm SMD	D10xL12.7mm	PCV1E271MCL1GS	Nichicon
C9, C10	2	10uF	CAP, CERM, 10 uF, 25 V, ±10%, X7R, 1210	1210	885012209028	Würth Elektronik
C11, C13	2	0.1uF	CAP, CERM, 0.1 uF, 25 V, ±10%, X7R, 0603	0603	C1608X7R1E104K080AA	TDK
C12	1	1000pF	CAP, CERM, 1000 pF, 50 V, ±10%, X7R, 0603	0603	C0603X102K5RACTU	Kemet
C14, C22	2	0.01uF	CAP, CERM, 0.01 uF, 25 V, ±5%, C0G/NP0, AEC-Q200 Grade 1, 0603	0603	C0603C103J3GCAUTO	Kemet
C15	1	4.7uF	CAP, CERM, 4.7 uF, 35 V, ±10%, X5R, 0603	0603	GRM188R6YA475KE15D	MuRata
C16	1	0.33uF	CAP, CERM, 0.33 uF, 100 V, ±10%, X7R,		C3216X7R2A334K130AA	TDK
C17	1	1uF	CAP, CERM, 1 uF, 16 V, ±20%, X7R, AEC-Q200 Grade 1, 0603	0603	GCM188R71C105MA64D	MuRata
C18	1	0.1uF	CAP, CERM, 0.1 uF, 50 V, ±10%, X7R, 0603	0603	C1608X7R1H104K080AA	TDK
C19	1	470pF	CAP, CERM, 470 pF, 100 V, ±5%, X7R, 0603	0603	06031C471JAT2A	AVX
C20	1	4.7uF	CAP, CERM, 4.7 uF, 10 V, ±20%, X7S, 0603	0603	GRM188C71A475KE11D	MuRata
C21	1	220pF	CAP, CERM, 220 pF, 50 V, ±5%, C0G/NP0, 0603	0603	C0603C221J5GACTU	Kemet
C24, C26	2	0.22uF	CAP, CERM, 0.22 uF, 16 V, ±10%, X7R, AEC-Q200 Grade 1, 0603	0603	CL10B224K08VPNC	Samsung

Table 7-1. LM5156HEVM-FLY Bill of Materials (continued)

Designator	QTY	Value	Description	Package Reference	Part Number	Manufacturer
C28	1	1000pF	CAP, CERM, 1000 pF, 2000 V, $\pm 10\%$, X7R, 1812	1812	1812GC102KA1	AVX
D1	1	40V	Diode, Schottky, 40 V, 10 A, AEC-Q101, TO-277A	TO-277A	SS10P4-M3/87A	Vishay-Semiconductor
D2, D5	2	100V	Diode, Switching, 100 V, 0.2 A, SOD-323	SOD-323	MMDL914-TP	Micro Commercial Components
D3	1	150V	Diode, Superfast Rectifier, 150 V, 1 A, SMA	SMA	ES1C-13-F	Diodes Inc.
D4	1	30V	Diode, Schottky, 30 V, 0.2 A, SOT-323	SOT-323	BAT54SWT1G	Fairchild Semiconductor
H1, H2, H3, H4	4		Bumpon, Cylindrical, 0.312 X 0.200, Black	Black Bumpon	SJ61A1	3M
J1, J2	2		Terminal Block, 5mm, 2-pole, TH	TH, 2-Leads, Body 10x9mm, Pin Spacing 5mm	ED350/2	On-Shore Technology
J3, TP9	2		TEST POINT SLOTTED .118", TH	Test point, TH Slot Test point	1040	Keystone
J5	1		Header, 100mil, 3x1, Gold, TH	3x1 Header	TSW-103-07-G-S	Samtec
Q1	1	100V	MOSFET, N-CH, 100 V, 13 A, DQJ0008A (VSONP-8)	DQJ0008A	CSD19533Q5A	Texas Instruments
R1	1	15.0	RES, 15.0, 1%, 0.5 W, 1210	1210	ERJ-14NF15R0U	Panasonic
R2, R11	2	100	RES, 100, 1%, 0.1 W, AEC-Q200 Grade 0, 0603	0603	ERJ-3EKF1000V	Panasonic
R3	1	0	RES, 0, 1%, 0.1 W, AEC-Q200 Grade 0, 0603	0603	RMCF0603ZT0R00	Stackpole Electronics Inc
R4	1	30.1k	RES, 30.1 k, 1%, 1 W, AEC-Q200 Grade 0, 2512	2512	CRCW251230K1FKEG	Vishay-Dale
R6, R9	2	100k	RES, 100 k, 1%, 0.1 W, AEC-Q200 Grade 0, 0603	0603	CRCW0603100KFKEA	Vishay-Dale
R7	1	10.0	RES, 10.0, 1%, 0.1 W, AEC-Q200 Grade 0, 0603	0603	CRCW060310R0FKEA	Vishay-Dale
R8, R10, R24	3	0	RES, 0, 5%, 0.1 W, AEC-Q200 Grade 0, 0603	0603	ERJ-3GEY0R00V	Panasonic
R12	1	0.02	RES, 0.02, 1%, 1 W, 0612	0612	PRL1632-R020-F-T1	Susumu Co Ltd
R13	1	49.9k	RES, 49.9 k, 1%, 0.1 W, AEC-Q200 Grade 0, 0603	0603	ERJ-3EKF4992V	Panasonic

Table 7-1. LM5156HEVM-FLY Bill of Materials (continued)

Designator	QTY	Value	Description	Package Reference	Part Number	Manufacturer
R14	1	1.00k	RES, 1.00 k, 1%, 0.1 W, 0603	0603	ERJ-3EKF1001V	Panasonic
R16, R22	2	9.76k	RES, 9.76 k, 1%, 0.1 W, AEC-Q200 Grade 0, 0603	0603	CRCW06039K76FKEA	Vishay-Dale
R17	1	86.6k	RES, 86.6 k, 1%, 0.1 W, AEC-Q200 Grade 0, 0603	0603	CRCW060386K6FKEA	Vishay-Dale
R18	1	4.99k	RES, 4.99 k, 1%, 0.1 W, AEC-Q200 Grade 0, 0603	0603	CRCW06034K99FKEA	Vishay-Dale
R19	1	30.0k	RES, 30.0 k, 1%, 0.1 W, 0603	0603	RC0603FR-0730KL	Yageo
R20, R21	2	1.00k	RES, 1.00 k, 0.1%, 0.1 W, AEC-Q200 Grade 0, 0603	0603	ERA3AEB102V	Panasonic
SH-J1	1	1x2	Shunt, 100mil, Gold plated, Black	Shunt	SNT-100-BK-G	Samtec
T1	1	21uH	Transformer, 21 uH, SMT	13.97x18.25mm	750317933	Würth Elektronik
TP1, TP2	2		Test Point, Miniature, Red, TH	Red Miniature Testpoint	5000	Keystone
TP3, TP4, TP8	3		Test Point, Miniature, Black, TH	Black Miniature Testpoint	5001	Keystone
TP10	1		Test Point, Miniature, White, TH	White Miniature Testpoint	5002	Keystone
U1	1		2.2MHz Wide VIN Non-synchronous Boost/SEPIC/Flyback Controller with Dual Random Spread Spectrum	HTSSOP14	LM51561QPWPRQ1	Texas Instruments
U2	1		Optocoupler, 2.5 kV, 100-200% CTR, SMT	PS2811-1	PS2811-1-M-A	California Eastern Laboratories
U3	1		Low-Voltage (1.24V) Adjustable Precision Shunt Regulators, 3-pin SOT-23, Pb-Free	DBZ0003A	LMV431BIMF/NOPB	Texas Instruments

IMPORTANT NOTICE AND DISCLAIMER

TI PROVIDES TECHNICAL AND RELIABILITY DATA (INCLUDING DATA SHEETS), DESIGN RESOURCES (INCLUDING REFERENCE DESIGNS), APPLICATION OR OTHER DESIGN ADVICE, WEB TOOLS, SAFETY INFORMATION, AND OTHER RESOURCES "AS IS" AND WITH ALL FAULTS, AND DISCLAIMS ALL WARRANTIES, EXPRESS AND IMPLIED, INCLUDING WITHOUT LIMITATION ANY IMPLIED WARRANTIES OF MERCHANTABILITY, FITNESS FOR A PARTICULAR PURPOSE OR NON-INFRINGEMENT OF THIRD PARTY INTELLECTUAL PROPERTY RIGHTS.

These resources are intended for skilled developers designing with TI products. You are solely responsible for (1) selecting the appropriate TI products for your application, (2) designing, validating and testing your application, and (3) ensuring your application meets applicable standards, and any other safety, security, regulatory or other requirements.

These resources are subject to change without notice. TI grants you permission to use these resources only for development of an application that uses the TI products described in the resource. Other reproduction and display of these resources is prohibited. No license is granted to any other TI intellectual property right or to any third party intellectual property right. TI disclaims responsibility for, and you will fully indemnify TI and its representatives against, any claims, damages, costs, losses, and liabilities arising out of your use of these resources.

TI's products are provided subject to [TI's Terms of Sale](#) or other applicable terms available either on ti.com or provided in conjunction with such TI products. TI's provision of these resources does not expand or otherwise alter TI's applicable warranties or warranty disclaimers for TI products.

TI objects to and rejects any additional or different terms you may have proposed.

Mailing Address: Texas Instruments, Post Office Box 655303, Dallas, Texas 75265
Copyright © 2022, Texas Instruments Incorporated