

TMS370 Microcontroller/Gang Programmer

User's Guide

PRELIMINARY

PRELIMINARY



**TEXAS
INSTRUMENTS**

2546239-9704

***TMS370 Microcontroller/Gang
Programmer
User's Guide***

SPNU023
February, 1991



IMPORTANT NOTICE

Texas Instruments (TI) reserves the right to make changes to its products or to discontinue any semiconductor product or service without notice, and advises its customers to obtain the latest version of relevant information to verify, before placing orders, that the information being relied on is current.

TI warrants performance of its semiconductor products and related software to the specifications applicable at the time of sale in accordance with TI's standard warranty. Testing and other quality control techniques are utilized to the extent TI deems necessary to support this warranty. Specific testing of all parameters of each device is not necessarily performed, except those mandated by government requirements.

Certain applications using semiconductor products may involve potential risks of death, personal injury, or severe property or environmental damage ("Critical Applications").

TI SEMICONDUCTOR PRODUCTS ARE NOT DESIGNED, INTENDED, AUTHORIZED, OR WARRANTED TO BE SUITABLE FOR USE IN LIFE-SUPPORT APPLICATIONS, DEVICES OR SYSTEMS OR OTHER CRITICAL APPLICATIONS.

Inclusion of TI products in such applications is understood to be fully at the risk of the customer. Use of TI products in such applications requires the written approval of an appropriate TI officer. Questions concerning potential risk applications should be directed to TI through a local SC sales office.

In order to minimize risks associated with the customer's applications, adequate design and operating safeguards should be provided by the customer to minimize inherent or procedural hazards.

TI assumes no liability for applications assistance, customer product design, software performance, or infringement of patents or services described herein. Nor does TI warrant or represent that any license, either express or implied, is granted under any patent right, copyright, mask work right, or other intellectual property right of TI covering or relating to any combination, machine, or process in which such semiconductor products or services might be or are used.

Preface

Read This First

How to Use This Manual

This manual describes how to use and operate the TMS370 Microcontroller Programmer and the TMS370 Gang Programmer. Chapter 1 gives an overview of each programmer and describes the correct way to install your specific programmer. After your programmer is correctly installed, you can use the *configuration commands* and *display commands*, described in Chapters 2 and 3, respectively, to operate your programming system for your specific application.

This document contains the following chapters:

- Chapter 1 Introduction and Installation**
Presents a general description of how each programmer operates and the features available with each programmer. Also outlines the proper hardware and software installation procedures.
- Chapter 2 Operating in the Configuration Window**
Describes how the command menus and function keys operate and how to input information at the system prompt. Describes the commands available while operating in the configuration window.
- Chapter 3 Operating in the Display Window**
Describes how the command menus and function keys operate and how to input information at the system prompt. Describes the commands available while operating in the display window.
- Appendix A Operating the Programmer in Batch Mode**
Outlines how to create a configuration/batch file and how to invoke the file at system start-up.
- Appendix B Error Messages**
Provides an alphabetical list of error messages and their meaning.
- Appendix C Valid Configuration Parameters**
Lists valid configuration parameters for the devices supported by the programmers.
- Appendix D Using Keystroke Capture Files**
Describes how to use keystroke capture files to repeat a commonly used program and to verify routines.

Related Documentation

The following TMS370 documents are available through Texas Instruments Incorporated:

The **TMS370 Family Data Manual** (literature number SPNS014) describes the hardware aspects of the TMS370, such as pin functions, architecture, stack operation, and interface; the manual also includes the TMS370 assembly language instruction set.

The **TMS370 Family Assembly Language Tools** (literature number SPNU010) describes how to use of the TMS370 assembly language tools (assembler, linker, archiver and code conversion utility) to create and use objects that are in common object file format (COFF).

The **TMS370 Family C Compiler** (literature number (SPNU022) describes the characteristics and operation of the TMS370 C Compiler.

The **TMS370 Family XDS/22 User's Guide** (literature number SPNU008) describes the hardware and software installation of the TMS370 Family XDS22 consisting of the TMS370 debugger and emulator.

The **TMS370 PACT XDS/22 Addendum** (literature number SPNU019) describes features and functions of the TMS370 PACT XDS/22. Use this addendum in conjunction with the *TMS370 Family XDS/22 User's Guide*.

The **TMS370 Family XDS/11 User's Guide** (literature number SPNU015) describes the hardware and software installation of the TMS370 Family XDS11 consisting of the TMS370 debugger and emulator.

Style and Symbol Conventions

This document uses the following conventions.

- Program listings, program examples, interactive displays, filenames, and symbol names are shown in a special typeface similar to a typewriter's. Examples use a **bold version** of the special typeface for emphasis; interactive displays use a **bold version** of the special typeface to distinguish commands that you enter from items that the system displays (such as prompts, command output, error messages, etc.).

Here is a sample program listing:

```
0011 0005 0001      .field    1, 2
0012 0005 0003      .field    3, 4
0013 0005 0006      .field    6, 3
0014 0006           .even
```

Information About Cautions and Warnings

This book may contain cautions and warnings.

- ❑ A **caution** describes a situation that could potentially damage your software or equipment.

This is what a caution looks like.

CAUTION

- ❑ A **warning** describes a situation that could potentially cause harm to **you**.

This is what a warning looks like.

WARNING

The information in a caution or a warning is provided for your protection. Please read each caution and warning carefully.

Trademarks

MS-DOS is a trademark of Microsoft Corp.

XDS is a trademark of Texas Instruments Incorporated.

PC/AT is a trademark of International Business Machines Corporation.

Contents

1	Introduction and Installation	1-1
1.1	Microcontroller Programmer Overview and Description	1-2
1.2	Gang Programmer Overview and Description	1-4
1.2.1	Operating the Gang Programmer in PC Mode	1-6
1.2.2	Operating the Gang Programmer in Standalone Mode	1-6
1.3	Properly Installing the Programmer Hardware	1-8
1.3.1	Connecting a Programmer to the PDS Base Unit	1-8
1.3.2	Power Connection	1-9
1.3.3	Connection to a PC	1-9
1.3.4	Connection to an XDS	1-9
1.3.5	Integrated Circuit (IC) Insertion	1-11
1.4	Properly Installing the Programmer Software	1-14
1.4.1	Installing the Software in a Single Directory	1-14
1.4.2	Installing the Software in Multiple Directories	1-14
1.5	Invoking the Programmer Software	1-16
1.6	Getting Started—Example Sessions	1-17
1.6.1	Interactive Programming Example 1	1-17
1.6.2	Interactive Programming Example 2	1-19
1.6.3	Batch Programming Example	1-19
2	Operating in the Configuration Window	2-1
2.1	How Command Menus Work	2-2
2.2	Using the Special Function Keys	2-3
2.3	What Happens If I Make an Error?	2-3
2.4	Understanding Your Input at the Cursor Prompt	2-4
2.5	Configuration Window Overview and Description	2-5
2.6	Secondary Configuration Window—the Show Ranges Window	2-7
2.6.1	Selecting the Proper Program Algorithm	2-8
2.7	Showing the Software Revision Information — the Show ID Command	2-9
2.8	Defining and Adding a Device to the Device Table—the Add Device Command	2-9
2.9	Editing the Configuration Parameters and Device Table — the Edit Command	2-11
2.9.1	Editing the Configuration Parameters	2-11
2.9.2	Editing the Device Table	2-12
2.10	Loading the Device Table and Configuration Parameters From a File — the Load Command	2-14
2.11	Selecting a Current Device — the Choose Device Command	2-15

2.12	Saving Configuration Parameters and the Device Table to a File — the Save Command	2-15
2.13	Showing the Display Window — the Display Command	2-16
2.14	Ending Your Current Session and Returning to DOS — the Quit Command	2-16
3	Operating in the Display Window	3-1
3.1	How Command Menus Work	3-2
3.2	Using the Special Function Keys	3-3
3.3	What Happens If I Make an Error	3-3
3.4	Understanding Your Input at the Prompt	3-4
3.5	Display Window Overview and Description	3-5
3.5.1	Differences in Command Structures for Microcontroller Programmer and Gang Programmer	3-7
3.6	Filling a Block of PC Memory With a Value — the Fill Command	3-8
3.7	Loading a COFF File Into PC Memory—the Load Command	3-9
3.8	Outputting a COFF File From PC Memory — the Output COFF Command	3-10
3.9	Moving Blocks of PC Memory—the Move Command	3-12
3.10	Programming a Device From PC Memory — the Program Command	3-13
3.10.1	Programming Using the Microcontroller Programmer	3-13
3.10.2	Programming Using the Gang Programmer	3-15
3.11	Showing and Operating Within a Text File—the Show Command	3-17
3.11.1	Finding Character Strings Within a Text File — the Find Command	3-18
3.11.2	Finding the Next Occurrence of Character String — the Next Command	3-18
3.11.3	Positioning the Cursor at a Specific Line Number — the Line Command	3-18
3.11.4	Positioning the Cursor at Top of a File — the Top Command	3-18
3.11.5	Positioning the Cursor at the Bottom of a File — the Bottom Command	3-18
3.12	Uploading a Device's Contents Into PC Memory—the Upload Command	3-19
3.12.1	Uploading Using the Microcontroller Programmer	3-19
3.12.2	Uploading Using the Gang Programmer	3-20
3.13	Verifying the Contents of a Device—the Verify Command	3-22
3.13.1	Verifying Using the Microcontroller Programmer	3-22
3.13.2	Verifying Using the Gang Programmer	3-23
3.14	Editing the Contents of PC Memory—the Edit Command	3-26
3.15	Using the Master Mode Menu—the Master Command	3-27
3.16	Suspending the Program and Entering DOS—the System Command	3-28
3.17	Quitting the Program and Exiting to DOS—the Quit Command	3-28
A	Operating the Programmer in Batch Mode	A-1
A.1	Understanding the Batch Mode File	A-2
A.2	Batch File Command Rules and Descriptions	A-3
A.2.1	Executable Batch Commands	A-3
A.2.2	Nonexecutable Batch Commands	A-4
A.3	Batch Mode Status Messages	A-5
B	Error Messages	B-1
B.1	Error Message Descriptions	B-2
C	Configuration Parameters	C-1
D	Using Keystroke Capture Files	D-1

Figures

1-1.	Microcontroller Programmer Personality Module	1-2
1-2.	Gang Programmer Board	1-4
1-3.	Socket Identification	1-11
2-1.	Command Menu Structure	2-2
2-2.	Configuration Window at System Startup	2-5
2-3.	The Show Ranges Window	2-7
2-4.	Valid Address Ranges Window	2-12
3-1.	Command Menu Structure	3-2
3-2.	PC Memory Display and Reverse Assembled Code Windows	3-5

Tables

1-1.	XDS Memory Expansion/Communications Board Switch Settings	1-10
2-1.	Edit Control Keys	2-4
2-2.	Configuration Window Commands	2-5
2-3.	Show Ranges Parameter Summary	2-7
2-4.	Device Table Edit Commands	2-12
3-1.	Edit Control Keys	3-4
3-2.	Display Window Commands	3-6
3-3.	Reverse Assembled Code Window Commands	3-7
3-4.	Show Text File Commands	3-17
3-5.	Display Window Memory Edit Commands	3-26
C-1.	Valid Configuration Parameters	C-1
D-1.	Valid Nonprintable Characters	D-2

Examples

A-1.	Example Configuration/Batch File	A-2
D-1.	Keystroke File Example.key	D-2

Introduction and Installation

This chapter describes how each programmer operates, how to install hardware, and how to install software. It also gives examples on getting started.

Chapter 1 comprises the following sections:

Section	Page
1.1 Microcontroller Programmer Overview and Description	1-2
1.2 Gang Programmer Overview and Description	1-4
1.3 Properly Installing the Programmer Hardware	1-8
1.4 Properly Installing the Programmer Software	1-14
1.5 Invoking the Programmer Software	1-16
1.6 Getting Started—Example Sessions	1-17

Because of obvious differences between the *microcontroller programmer* and the *gang programmer*, **icons** are used to distinguish descriptions and information specific to each type of programmer. When there are no icons present, you should assume the information is common to all programmers.



This icon is used to distinguish descriptions and information specific to the microcontroller programmer.



This icon is used to distinguish descriptions and information specific to the gang programmer.

When an icon is present, the information from the icon to the next icon, *or to the next section number (that is, 2.1, 2.2, 3.5, etc.)*, is specific to the programmer symbolized by the icon.

Texas Instruments provides a hotline to assist you with technical questions about the TMS370 family products and development tools. Phone (713) 274-2370 between the hours of 8:30 a.m. and 5:00 p.m. central time for technical assistance.

1.1 Microcontroller Programmer Overview and Description



The TMS370 Microcontroller Programmer is an interactive, menu-driven system that facilitates programming TMS370 family devices and EPROMs either directly or through an XDS. The microcontroller programmer is currently capable of programming the TMS370, TMS7742, TMS77C82, 2732, 2764, 27128, and 27256 device families. To program the TMS7742 and TMS77C82 devices, you will need a 40-pin to 28-pin converter, which is sold separately.

Figure 1-1. Microcontroller Programmer Personality Module

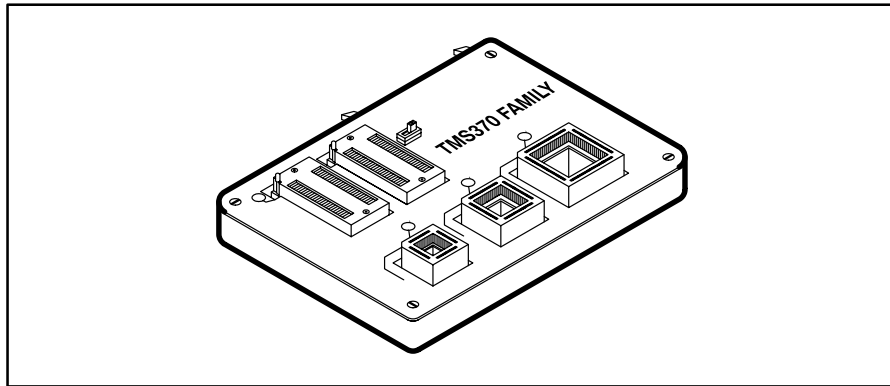

To operate the programmer, create a COFF file using the TMS370 Assembler and Linker on a PC. The programmer loads the object code from the COFF file into PC memory and programs a device from the data in PC memory. The device is programmed and verified in units (packets) of 180 bytes at a time.

The programmer software has the following features:

- Window-oriented screens with a menu-driven command structure.
- Intermediate PC memory, which provides a storage area for downloading a COFF file or uploading from the device. This allows you to inspect and patch the loaded data.
- Reversed assembly code display.
- Ability to generate a COFF file from PC memory content.
- Relocatable programming capability, which allows source data bytes within a certain address range to be programmed at a specified location in the device.
- User-defined device types that allow new family members.
- Ability to save or load the programmer configuration to or from a *configuration/batch file*.

In addition to these features, a limited batch mode is also supported.

The base unit of the programmer contains two LEDs. The red LED is marked *program* or *device power* and is lit whenever power is applied to device sockets. The green LED is marked *power* and indicates that the base is turned on. This LED should turn on approximately three seconds after power is supplied to the programmer.

Do not insert or remove devices from the programmer while the red *program (device power)* LED is lit!

On the front edge of the programmer base is a black banana plug receptacle. This is attached to the safety ground of the power cord in order to assist you in connecting to electrostatic protection equipment.

1.2 Gang Programmer Overview and Description



The TMS370 Gang Programmer is an interactive, menu-driven system that provides programming support for on-chip EEPROM or EPROM of TMS370 microcontrollers in production environments.

The gang programmer has the following features:

- ❑ Two modes of operation—PC mode and standalone mode.
- ❑ Ability to program up to 16 devices.
- ❑ LEDs that indicate programming or verification failure.
- ❑ A buzzer that indicates programming completion.

The gang programmer consists of the standard programmer base, a gang programmer top, and the standard programmer software. If you already have a standard TMS370 Microcontroller programmer, the gang programmer top can be purchased separately. (There is a different programmer top for each package of TMS370 microcontrollers.)

Figure 1-2. Gang Programmer Board

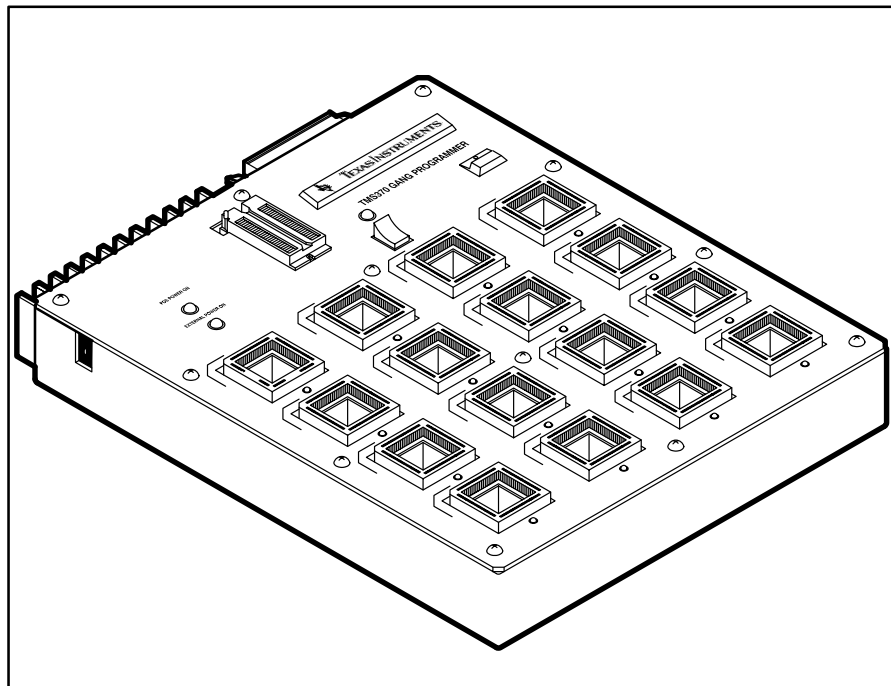

The push-button switch in the upper right-hand corner is marked *start* and is used to start and stop programming or verification while operating in the stand-

alone mode; it is ignored in PC mode. The red LED built into this switch is marked *TMS370 power on* and indicates that power is being supplied to the sockets on the gang programmer.

Do not insert or remove devices from the programmer while the red *TMS370 power on* LED is lit!

The main body of the gang programmer consists of 16 sockets whose type and arrangement are dependent on the type of gang programmer top you have. Below each socket is a red LED, which is used to indicate a failure of the device in the socket immediately above the LED. These sockets are mounted on base sockets to allow easy replacement if a socket is damaged.

The rocker switch on the top center of the gang programmer board is used to select program or verify when used in standalone mode; it is ignored in PC mode. The red LED just above this switch is lit when the switch is in the program position.

There are two green LEDs on the left top of the gang programmer. The top LED is marked *PDS power on* and indicates that the base unit is turned on. The lower LED is marked *external power on* and is used to indicate that the external +15V is properly connected to the programmer top. The external power jack is located on the upper left side of the programmer top.

Typically, this programmer is used in PC mode to program initial units. However, you can use the 28-pin DIP socket at the top center of the programmer to program a 27C512 EPROM as a master device. As the master device is programmed, a checksum is calculated and added to the configuration information stored in the master device. This allows the programmer to verify that the master device has not become corrupted before it is used to program additional units. Once programmed, this master contains all of the configuration data as well as the code to be programmed into the microcontrollers. Now, the gang programmer with the master device can be moved to a production environment where you can easily program parts without the use of a personal computer; this is called **standalone mode**.

1.2.1 Operating the Gang Programmer in PC Mode

In *PC mode*, the gang programmer is an interactive, menu-driven system that facilitates programming TMS370 family devices and EPROMs. The system allows you to perform any or all of the operations listed below.

- Program any or all of the 16 devices from PC memory
- Modify or add a new device to the device table
- Verify any or all devices against either PC memory or the master device.
- Upload any of the 16 devices.
- Program the 512K master device.
- Upload the master device with or without configuration data.
- Enter standalone mode.

When you program in PC mode, all LEDs are turned on for a predetermined time as part of an LED test. Then, the software checks whether a device exists in each socket and whether it is properly installed by running a small read-write test. If any device fails, the LED for that device blinks for a few seconds, there are two short audible beeps, and the following error message is displayed:

```
Device test failed, continue? (y/n)
```

If you have incorrectly inserted any device(s), you can fix them at this time. If only empty sockets failed, you can continue the programming by pressing Y. The LED of the failed device(s) remains on during programming. At the end of programming if there is a verification error on any other device, its LED turns on also.

In the PC mode, the push button on the gang programmer is deactivated. The interactive commands for this mode are discussed in Chapter 2 and 3.

The gang programmer's ability to execute any or all of the programmer commands on a *master* device allows you to program a master device for use in standalone mode or to verify programmed devices against the master device or PC memory while in PC mode.

1.2.2 Operating the Gang Programmer in Standalone Mode

In *standalone mode*, the programmer works without the PC interface. You can access the standalone mode from the PC mode by selecting the standalone command; when the PC is not connected to the Gang Programmer during power-up, standalone mode is automatically selected.

Standalone mode allows you to program and/or verify devices in a production-type mode.

After you install the master 512K EPROM device and any devices you wish to program or verify, the procedure for starting the programmer is quite simple.

- 1) Position the toggle switch to either the program position or the verification position.
- 2) Press the push button on the programmer.
While you press the push button, all 16 LEDs turn on, and remain on to verify LED operation, until you release the push button.
- 3) Release the push button to begin the programming or verification.
If any of the devices are bad or incorrectly inserted into a socket or if the socket is empty, the programmer beeps twice, and the LED below the socket begins blinking.
- 4) To resume programming/verification, press the push button (within a 2-second period).
- 5) If you want to correct the error, wait until the blinking LEDs stop blinking but remain on. At this time, insert a new device (or reinsert the old device) and try the programming/verification procedures again.
- 6) Once programming has begun, you can abort at any time by pressing the push button.

If you try to program without a master or with an invalid master device, all 16 LEDs blink until you acknowledge the error by pressing the push button.

1.3 Properly Installing the Programmer Hardware

Correctly installing the programmer hardware is essential to the proper operation of programmer system. The following subsections explain how to connect the programming board to the PDS base unit and the required power connections for connecting your programmer to a PC or TMS370 XDS. Also included in these subsections is a description of how to properly insert DIPs and PLCCs.

1.3.1 Connecting a Programmer to the PDS Base Unit

Connecting the programmer to the PDS is essentially the same for all programmers. The illustrations below show this process for the microcontroller programmer.

- 1) Line up the plastic tabs on the bottom of the programmer board with the insertion hole in the top of the PDS base unit.
- 2) Press firmly until tabs are set.
- 3) Connect the ribbon cable from the PDS base unit to the connection on the back of the programmer.

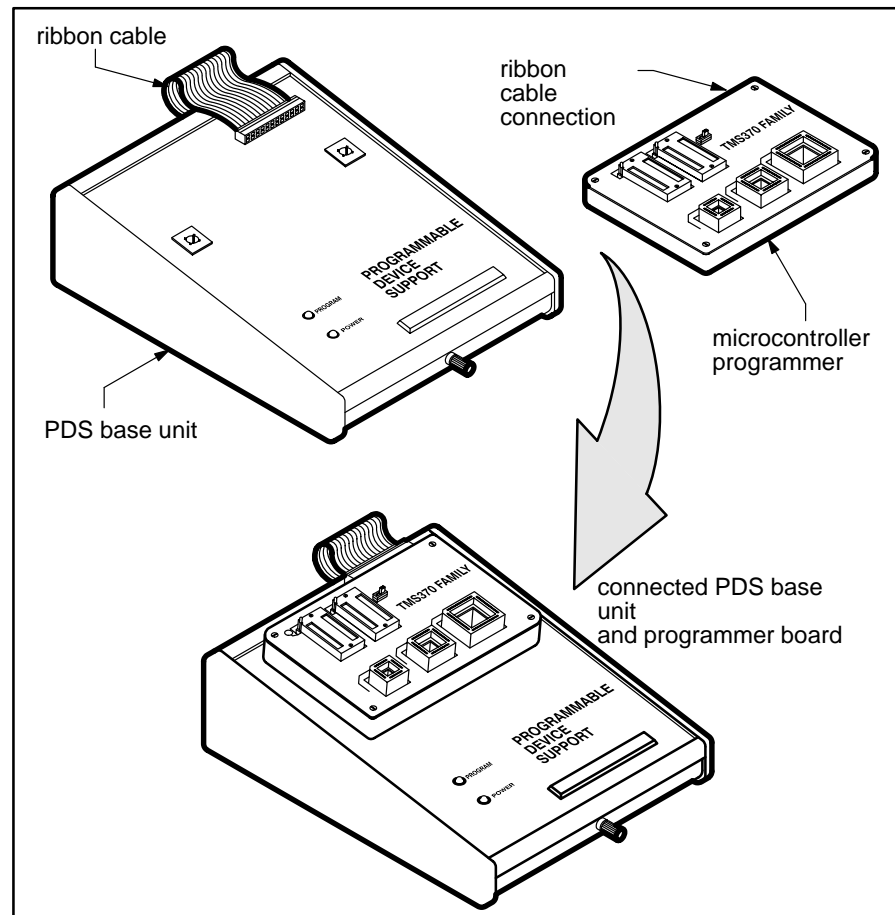

1.3.2 Power Connection

- ❑ Connect the female end of the power cord to the PDS base unit.
- ❑ The programmer can handle a power range of 105 to 265 volts AC at 47 to 440 hertz. All units are equipped with two power cords. If you are in the U.S.A., use the power cord with a male connector that can be plugged directly into a 120-V, 60-Hz power socket.
- ❑ Outside the U.S.A., use the power cord with no male connector because the type of receptacle to be used is unknown. Attach the appropriate connector for your power receptacle. The wires are color coded as follows:
 - Green and Yellow = Earth
 - Blue = Neutral
 - Brown = Live



The gang programmer also requires an external power supply of 15 volts/2 amps. The connection for this external power is marked EXTERNAL POWER and is positioned near the top left corner of the programmer's socket board. Plug the the jack of the +15-volt wire into the external power socket. Connect the white-striped wire to the +15-volt terminal of the power supply and the solid black wire to the ground terminal of the power supply.

1.3.3 Connection to a PC

- 1) Connect the end of the RS-232C cable consisting of a single 25-pin connector to the programmer.
- 2) Connect the end of the RS-232C cable consisting of two 25-pin connectors to the serial communication port of the PC. (If an IBM PC/AT is used, the 9-pin-to-25-pin converter cable provided must be used.)

1.3.4 Connection to an XDS

Connect the programmer through an XDS if you want to use both the XDS Debugger and the microcontroller programmer, and if the PC has only one communication port. Or, even if you have enough communication ports but do not want to change the port number when you switch from one tool to the other, you can use this method. The programmer works as if it is connected directly to the PC.

Complete the following steps to connect the programmer through an XDS.

- 1) Connect port D of an XDS to the programmer by using the RS-232C cable supplied with the programmer. The male connector on the double-headed end of the cable connects to the XDS; the single-headed end connects to the programmer.

- 2) Connect port A of the XDS to the PC by using the cable supplied with the XDS.
- 3) Ensure that the switches on the XDS Communications board are set as in Table 1–1.

Table 1–1. XDS Memory Expansion/Communications Board Switch Settings

Switch No.	S1	S2	S3	S4
1	Off	Off	Off	Off
2	Off	On	Off	Off
3	Off	Off	Off	Off
4	Off	On	On	Off
5	On	Off	On	On
6	Off	Off	On	On
7	On	On	On	Off

1.3.5 Integrated Circuit (IC) Insertion

ICs may be inserted or removed while power is applied to the programmer; however:

- 1) **When using the microcontroller programmer, never use more than one IC socket at a time. Damage to the IC or the programmer could result.**
- 2) **Never insert or remove the IC while the red LED is on. Damage to the IC or the programmer could result.**
- 3) **TMS devices contain circuits to protect their inputs and outputs against damage due to electrostatic discharges of up to 2 kV. However, you should employ the usual precautions when handling MOS devices, such as storing the device in conductive foam and grounding yourself when handling them.**



For the microcontroller programmer, decide which of the sockets (U1, U2, U3, U4, or U5) to use for your device. Figure 1–3, shows the circuit board and IC sockets.

Figure 1–3. Socket Identification

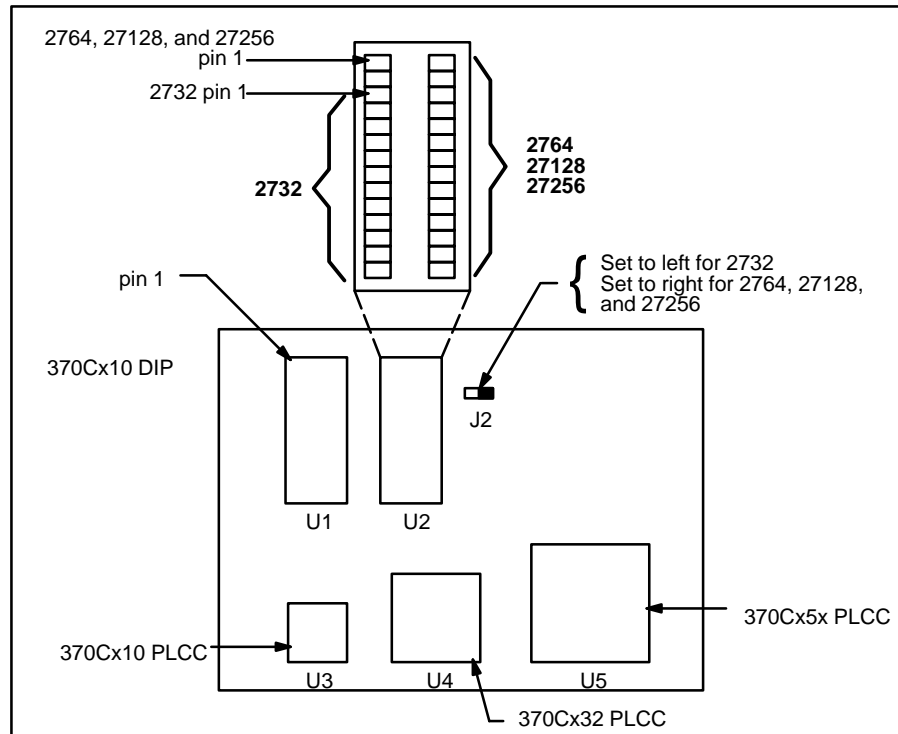

To install a DIP device:

- 1) Align the IC so that pin 1 is oriented in the upper-left corner, indicated on the printed circuit board by a circled number 1:
- 2) Raise the locking arm, pulling it toward you to the upright position.
- 3) Insert the IC.

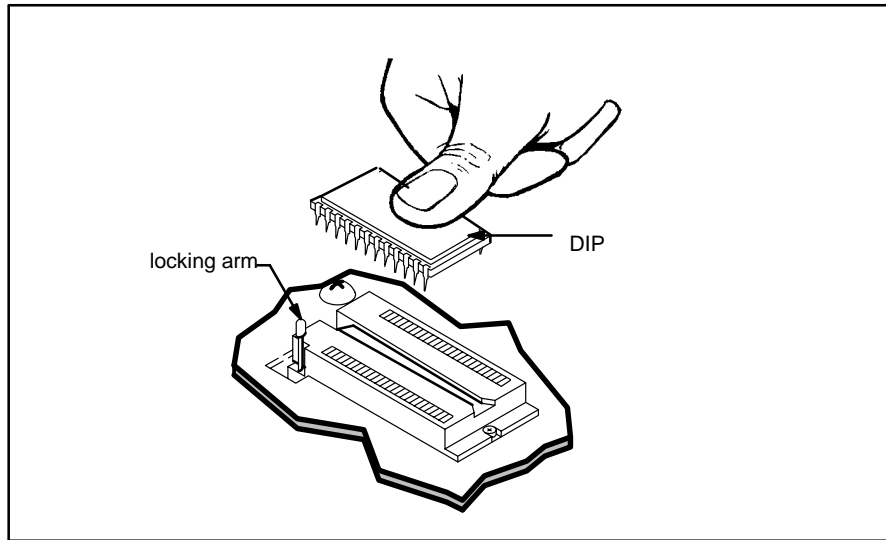

- 4) Lower the locking arm by pushing it away from you and down, as far as it will go.

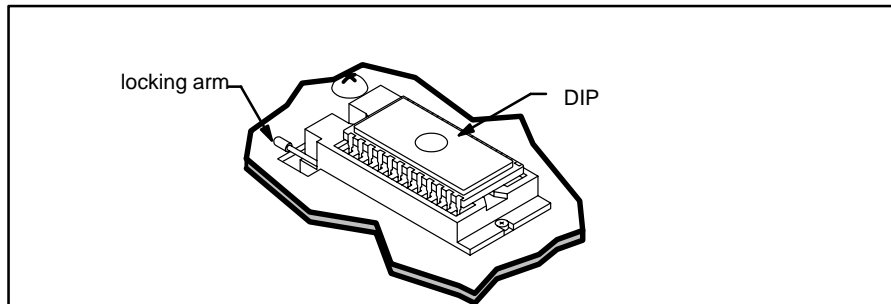

Note:

If you install a 2732 device in U2, be sure to use the bottom socket holes, leaving the top four socket holes unused. The correct position for a 2732 is indicated by a bracket on the printed circuit board to the left of the socket.

To install a PLCC device:

With this release of the programmers, the PLCC sockets do not have a lid; therefore, they are not sensitive to the device package height. These new sockets also have the pin 1 orientation at the top of each socket, making it less likely for you to insert a device backwards.

- 1) Place the PLCC in the empty socket.

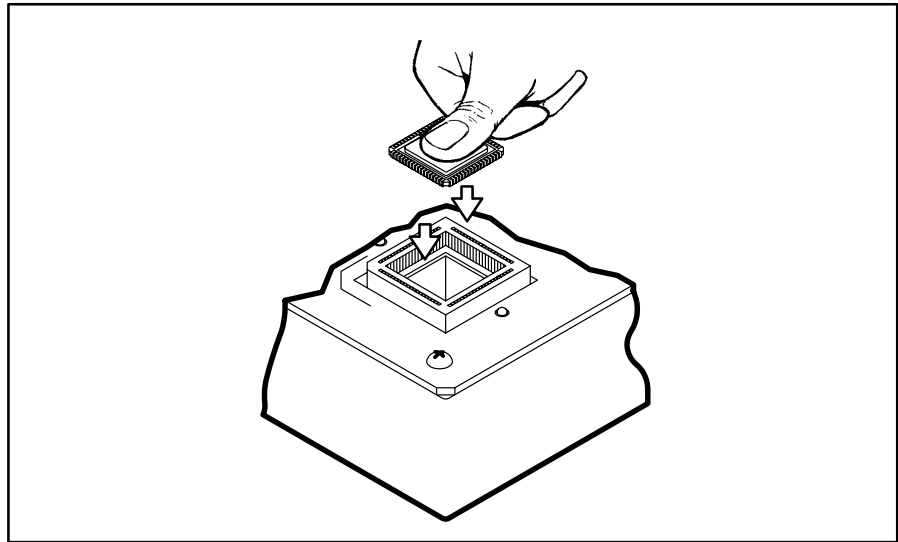

- 2) Press firmly until it is properly seated.

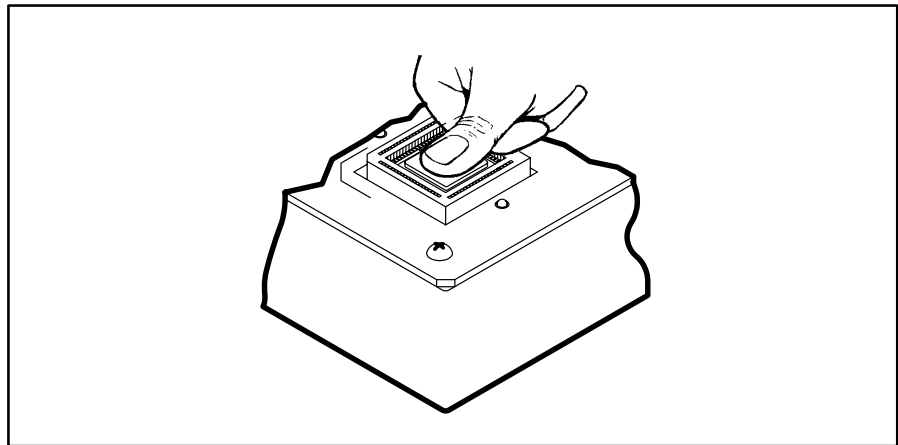

The programmer hardware is now ready to use.

To remove the device, press down firmly on the black plastic socket edges until the device is pushed upward and released.

1.4 Properly Installing the Programmer Software

Installing software is exactly the same whether you are using the Microcontroller Programmer or the Gang Programmer. Insert the diskette supplied with the programmer into the PC disk drive and use one of the following methods to copy the contents of the diskette to a directory in your hard disk.

1.4.1 Installing the Software in a Single Directory

This method is simple and suitable for a single user with only a few source files.

- 1) Make a directory to contain your programmer files.

```
MKDIR \370
```

- 2) Change your working directory to the directory you just created.

```
CD \370
```

- 3) Copy the files from the diskette.

```
COPY A:*.*
```

- 4) See Section 1.5 for a description of how to invoke the programmer software.

1.4.2 Installing the Software in Multiple Directories

This method is useful if there are several different users or if one user is working on several different projects.

- 1) Create a directory for your programmer files.

```
MKDIR \370
```

- 2) Copy the programmer files into your programmer directory:

```
COPY A:*. * \370\*. *
```

- 3) Create project directories.

```
MKDIR \PROJ1
```

```
MKDIR \PROJ2
```

- 4) Add the programmer directory to the path command in the AUTOEXEC.BAT file.

```
PATH C:\DOS;C:\PROG;C:\REP;C:\370
```

where C:\370 is the added path to the programmer directory.

- 5) Include a *set* command in the AUTOEXEC.BAT file as follows:

```
SET IPCDIR=C:\370
```

If the *device table* cannot be found elsewhere, the *set* command causes the programmer to search the programmer directory for the default device

table. The order in which the programmer looks for the device table is outlined below.

- a) First, it looks for a device table file specified in the configuration/batch file if the configuration/batch file was included in the command line to invoke the programmer software.

```
PRGRM370 @PROJ1.CFG
```

where PROJ1.CFG is the configuration/batch file.

- b) Next, it looks in the current directory for the default DEVICE.TBL.
 - c) Then, it looks in the directory specified by the "SET IPCDIR" command for the file DEVICE.TBL.
- 6) See Section 1.5 for a description of how to invoke the programmer software.

1.5 Invoking the Programmer Software

Before activating the programmer, be sure that it is plugged in and correctly connected as described in Section 1.3. Turn on the programmer's power switch (and the gang programmer's external power) before invoking the programmer software.

The command to run the programmer software from the DOS prompt is:

```
prgrm370 [COFF file] [@Config./Batchfile] [-b] [-p=port #]
```

where

<i>COFF file</i>	Optional argument that specifies a file to be programmed or verified in the batch control mode or loaded into PC memory in the interactive control mode.
<i>@Config./Batch file</i>	Optional argument that specifies a configuration/batch file that contains the configuration parameters or the batch commands for the batch control mode.
-b	Optional argument that turns on the batch mode if specified.
-p = port #	The communication port number to be used. Default is 1.

After you invoke the programmer software, the PC screen briefly displays a version number and copyright message.

If you specified a configuration/batch file but did not turn on the batch mode, the configuration specified in the file is loaded as the current configuration. Any other batch commands that would control the flow of the programming process are ignored.

If you specified a configuration/batch file and turned on the batch mode with the **-b** argument, the programmer software operates as directed by the batch file.

If you specified a port number and the programmer is not physically connected to that port, then the following error message is displayed.

```
Programmer not properly connected: Abort, Retry?
```

Aborting the invocation returns you to the DOS prompt. To retry the invocation, make sure the programmer is turned on and properly connected to the port specified in the command. Then, press **R** followed by **↵** to restart the programmer software.

Interactive mode commands are described in detail in Sections 2 and 3. Batch commands are covered in Appendix 1.

1.6 Getting Started—Example Sessions

This section will help you get a quick start using your programmer. Once you get started, the menu structure and prompts make the programmer easy to learn and to use. The remainder of this manual provides a detailed reference if you need further information on any of the commands, prompts, or error messages. Use the Table of Contents at the front of the manual and the Index at the end of the manual to direct you to the specific topic you need.

We assume that you are familiar with the TMS370 Assembler and Linker software and that a COFF file has been created that contains object code with which a device can be programmed. These are prerequisites to using the programmers and is beyond the scope of this manual.

1.6.1 Interactive Programming Example 1

This example assumes that the programmer software has been loaded onto your PC, and that the DOS prompt is `C:>`.

In this example you will invoke the programmer, choose a device to program, and use the `load` command to give the programmer the name of the object file and portion of the object code to be programmed onto the device.

- 1) From the DOS prompt, invoke the programmer to bring up the interactive display in the configuration window.

```
C:\>prgrm370 
```



The programmer title banner appears briefly; then the configuration window appears with the top line containing the following command menu:

```
CONFIG:showID AddDevice Edit Load ChooseDevice Save Display Quit
```

- 2) Place a TMS370 device in the appropriate socket; press  to select the choose device command.

The cursor moves down the screen to the beginning of the Device Table. Also, a function key command line containing the following commands appears at the bottom of the screen:

```
F1NextPage F2PrevPage F4ShowRanges F5SelectDev F6DeleteDev
```

- 3) Move the cursor to the appropriate device using the cursor arrow keys. Once you have found the correct device, press  to select the device.
- 4) Press  to return to the configuration command line, and then press  to move to the display window.

The display window command line contains the following commands:

```
Fill Load OutputCOFF Move ProgM Show Upload Verify Edit Config sYs Quit
```

- 5) Press  for the load command. The following prompt appears at the top line of the screen:

Object file:

- 6) Enter the name of the COFF file containing the object code with which the device is to be programmed. Press , and the following prompt appears:

Object base address: all

where *all* is the default, meaning that the entire object code address range is to be used.

- 7) Select the address range default of *all* by pressing  .

The cursor returns to the display window command line.

- 8) Press  to start the programming process. A prompt appears, asking for the name of a file in which programming errors are to be recorded.

Error file:

- 9) Enter a file name and press .

- 10) A prompt appears, asking for the starting address in PC memory of the data to be used in programming.

PC memory base address: all

- 11) Accept the default *all* by pressing .

- 12) Programming begins, and the bottom line of the screen is replaced by a status message informing you of the beginning address of the packet (180 bytes) currently being programmed. This line will be replaced by an error message if an error should occur. Otherwise, when programming is complete, the bottom line of the screen shows a prompt asking if another device is to be programmed using the same parameters.

Programming Complete, Program another device? (y/n)

Press *n* and then  to terminate programming and return to the display window command line. The device is now programmed and verified, assuming no error messages appeared.

1.6.2 Interactive Programming Example 2

This sample session illustrates entering the interactive mode with the COFF file automatically loaded into PC memory. If the programmer software is active, that is, in the display or configuration windows, press **Q** to quit the programmer and verify your choice. This returns the DOS environment.

- 1) At the DOS prompt, type the following command:

```
C:\>prgrm370 xyz.out
```

where *xyz.out* is the name of the COFF file containing the object code with which the device is to be programmed.

- 2) Press **Q**. The programmer software will start and automatically load the code in the *xyz.out* file into PC memory.

You can now operate the programmer in the interactive mode as usual. This method saves a few steps in loading the COFF file if the default load addresses are acceptable.

1.6.3 Batch Programming Example

This sample session illustrates batch mode programming. A configuration/batch file (not to be confused with a DOS batch file) must exist in order to use this method. If one does not, examine the detailed description in Appendix 1. For this example, assume that your configuration/batch file is named *abc.cfg*.

If the programmer software is active, that is, in the display or configuration windows, press **Q** to quit the programmer and verify your choice. This returns you to the DOS environment.

At the DOS prompt, type the following:

```
C:\>prgrm370 xyz.out @abc.cfg -b
```

where *xyz.out* is the COFF file and *abc.cfg* is the configuration/batch file. The **@** symbol is a delimiter identifying *abc.cfg* as a configuration/batch file, and the **-b** symbol turns on the batch mode. If the **-b** had been left off, the interactive mode would have been entered, and the configuration specified in the *abc.cfg* file would be used.

For more information on the batch mode, see Appendix 1.

Operating in the Configuration Window

This chapter describes the commands offered in the configuration window of the programmer's display.

The first part of this chapter explains how the command menus and function keys work; it also has a short section on entering information at the cursor prompt. *These sections are the same as the initial sections in Chapter 3; if you have already read these sections in Chapter 3, there is no need to read them in this chapter.*

The remainder of this chapter describes the operation of the configuration window and explains each configuration command, walking you through the interactive display prompts where applicable.

Section	Page
2.1 How the Command Menus Work	2-2
2.2 Using the Special Function Keys	2-3
2.3 What Happens If I Make an Error?	2-3
2.4 Understanding Your Input at the Cursor Prompt	2-4
2.5 Configuration Window Overview and Description	2-5
2.6 Secondary Configuration Window—the Show Ranges Window	2-7
2.7 Showing the Software Revision Information	2-9
2.8 Defining and Adding a Device to the Device Table	2-9
2.9 Editing the Configuration Parameters and Device Table	2-11
2.10 Loading the Device Table and Configuration Parameters From a File	2-14
2.11 Selecting a Current Device	2-15
2.12 Saving Configuration Parameters and the Device Table to a File	2-15
2.13 Showing the Display Window	2-16
2.14 Ending Your Current Session and Returning to DOS	2-16

2.1 How Command Menus Work

The interactive mode of the programmer is driven by *command menus* that are displayed on the top line of the screen. A command menu is a list of command names, each of which is displayed with one highlighted letter, usually the first character in the name. The highlighted letter is the key you use to invoke the command. You may type command letters in upper or lower case.

When you type a valid command letter, the programmer software clears the command line, displays the name of the selected command, and executes the command. Most commands require additional information, in which case the programmer either prompts for parameters or displays a submenu of commands.

Figure 2–1 shows the command menu structure. This figure is provided as a road map to the desired command(s).

Figure 2–1. Command Menu Structure

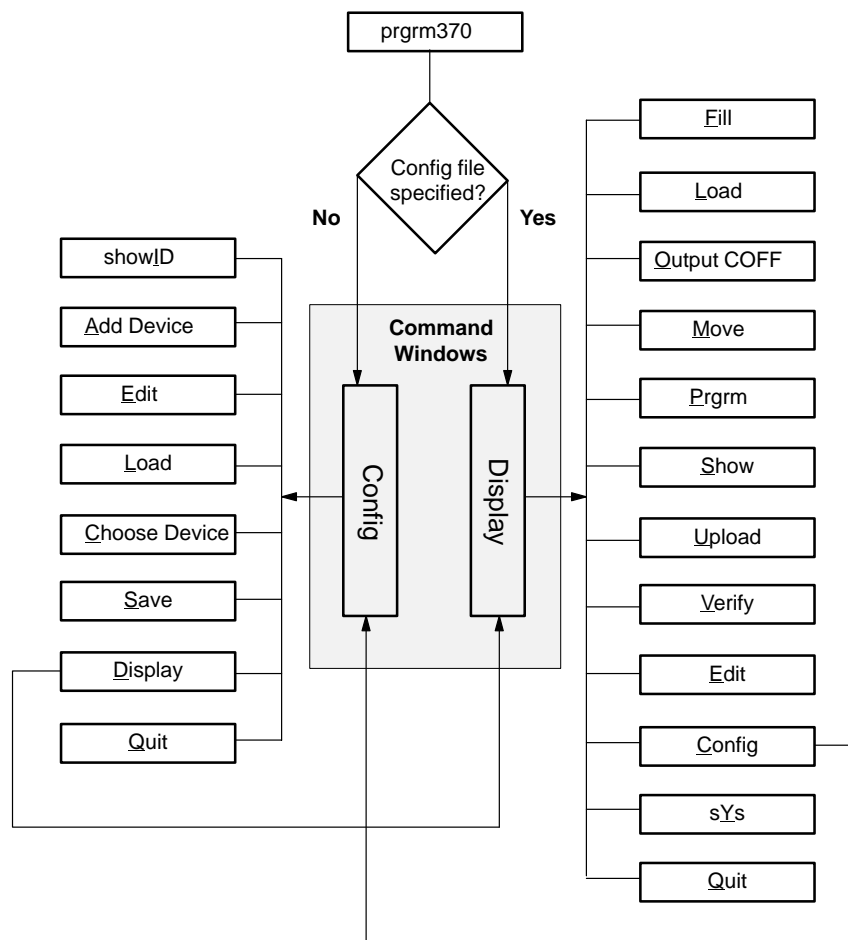

2.2 Using the Special Function Keys

Function keys **F1** through **F6** invoke various actions in the programmer, depending on your location in the command menu structure. The valid function keys and their definitions for each mode are displayed on the bottom line of the screen for reference. Press the highlighted key for the desired action.

Another special function key is **ESC**. If you ever need to abort a command and return to the next higher command menu level, press this function key. For example, if you are in the *fill memory* command, press **ESC** to return to the display command menu.

2.3 What Happens If I Make an Error?

If an error occurs, the programmer software displays an error message on the bottom line of the screen and prompts you to *hit any key* to escape from the error state. You can type any key, including **ESC**, on the keyboard. The message is then cleared, and the function key line is redisplayed.

If the error was caused by an input to a prompt, the programmer software returns to the prompt to let you re-enter a value. Otherwise, the software returns to the next higher command menu.

To find an explanation of any error message, refer to Appendix 2.

2.4 Understanding Your Input at the Cursor Prompt

The programmer software often requires you to enter a response to a prompt or to move the cursor to a value on the screen and modify it.

The previous or default value for the prompted parameter value is always displayed. You can accept the displayed default or former value by pressing only  in response to the prompt.

If you type a new value, the characters are highlighted, and the cursor advances to the next field position. *Only the highlighted characters are accepted by the programmer.* For example, assume that the displayed default value is 7020 (the underscored character indicates the cursor position). If you type 8 over the default value, you would see **8**020 on the screen (the boldface character indicates the highlighted character on the screen). If you then pressed the ENTER key, the value entered would be 0008, *not* 8020.

All numeric input values are hexadecimal except for the V_{CC} , V_{PP} , and program-pulse-duration-time values, which are decimal.









Table 2–1 lists special control keys. The effect of each key is given for both text and numeric fields. Any control key not listed in the table has the same effect as .

Table 2–1. Edit Control Keys

Key	Function
	Terminates input and accepts current value.
	Text: Inserts a space. Numeric: Terminates input and accepts current value.
	Text: Erases character to the left of cursor and backs up one space. Numeric: Erases character to the left of cursor and backs up one space.
	Text: Subsequently typed characters are inserted at the cursor position; characters to the right of the cursor are moved right, even out of the field. Remains in effect until the INSERT key or another control key is typed. Numeric: No effect.
	Text: Deletes character at cursor. Numeric: No effect.
	Text: Moves cursor left one space without erasing. Numeric: Moves cursor right one space without erasing.
	Text: Moves cursor right to the next character and highlights it. Numeric: Moves cursor right to the next character and highlights it.

2.5 Configuration Window Overview and Description

If you use the *configuration* command while in the display window, the **configuration window** illustrated in Figure 2–2 is displayed; it also displays when the programmer software is first invoked.

Figure 2–2. Configuration Window at System Startup

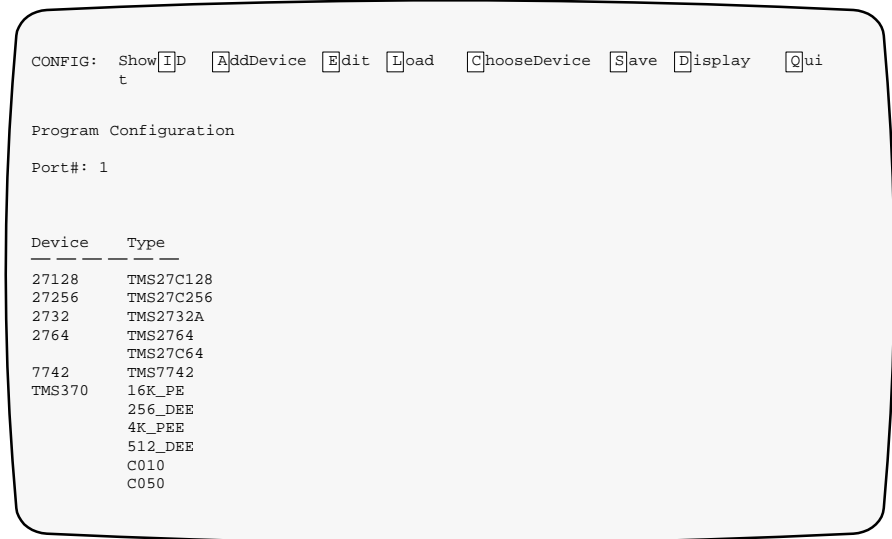

The configuration window consists of three different areas—a command line, a program configuration area, and the device table.

The *command line* lists the available commands you can use to manipulate the data in the configuration window. These commands are listed in Table 2–2 and described in detail in Sections 2.7 through 2.14.

Table 2–2. Configuration Window Commands

Command	Function
Show ID	Display software title and revision level.
Add Device	Add a new device to the device table.
Edit	Edit the configuration parameters.
Load File	Load current configuration or current device table from a file.
Choose Device	Choose (set) the current device type.
Save File	Save the current configuration or the current device table in a file.
Display	Go to the display window.
Quit	Quit (exit) and return to DOS.

The *program configuration area* lists the current selection of the communication port—port 1 or 2. To change this value, refer to Section 2.9.

The *device table* lists devices that can be programmed through the programmer. The device table displays 12 device types at a time and is sorted first by the device family names and then by the device first names. If there is more than one device type under one device family, the family name is displayed only once, on the first line of the device family. When a new device is specified or a device table is loaded from an outside file, the device table is automatically updated. If the actual device table contains more than 12 device types, you can use the function keys to scroll through the table. When a current device is selected, it is highlighted within the table.

The device table supplied with your programmer software includes all of the TMS370 devices available at the time the programmer was produced. As new configurations are made available, TI updates the DEVICE.TBL file and makes it available through our microcontroller bulletin board system. For information on how to use the bulletin board, contact the TMS370 hotline at the number indicated on page 1-1.

2.6 Secondary Configuration Window—the Show Ranges Window

A small subwindow appears when you select the *show ranges* function key, **F4**, from the device area of the configuration window. Figure 2–3 illustrates what the show ranges window looks like.

Figure 2–3. The Show Ranges Window

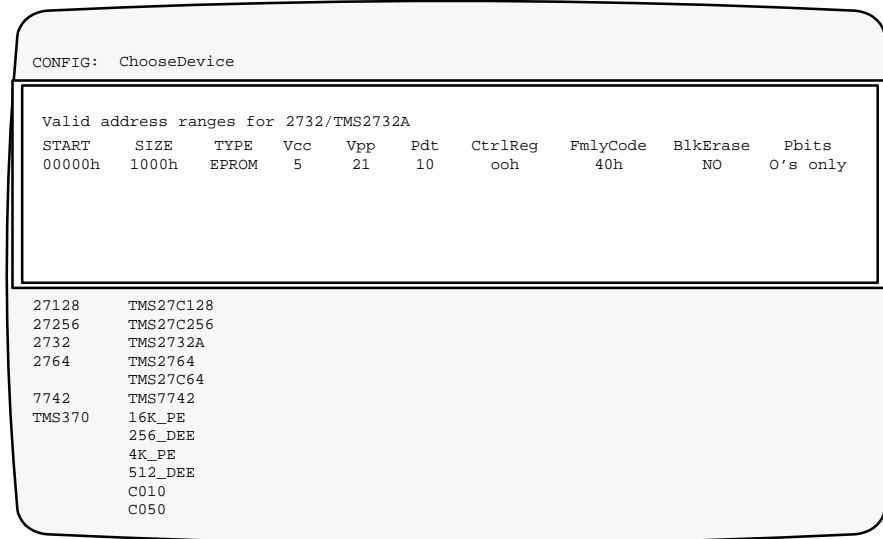

The show ranges window does not necessarily default to show the ranges of the chosen device. Instead, it shows the ranges of the device that the cursor is next to in the device table. You can scroll through the device table and notice the parameters changing in accordance with each new device the cursor is next to.

Table 2–3. Show Ranges Parameter Summary

Parameter	Description
Start	Valid start address for programming.
Size	Size of the valid program area.
Type	The type of memory in this range (EEPROM or EPROM).
VCC	Valid Vcc values are 0, 5, or 6 volts.
VPP	Valid Vpp values are 0, 5, 12, 12.5 or 21 volts.
pdt	Program pulse duration time.
ctrlReg	The control register.
FmlyCode	The hexadecimal family code of the device.
Blk-Erase	The block erase toggle.
Pbits †	The program algorithm.

† The program algorithms are discussed in detail in subsection 2.6.1.

2.6.1 Selecting the Proper Program Algorithm

For EEPROM memory in devices, there are three programming modes:

- ❑ writing 0s only, all 1s in the data bytes are ignored.
- ❑ writing 1s only, all 0s in the data bytes are ignored.
- ❑ writing 0s and 1s.

For all other types of memory, *writing 0s* is the only programming mode.

The three modes provided for the TMS370 allow the selection of the most efficient programming.

When the 1s and 0s mode is used, the programmer makes two passes through the address range, programming the 1s in one pass and the 0s in the other pass. Assume that the binary value 1010 1010 is to be programmed into a given address. First, the 1s are programmed, giving a value of $1x1x1x1x$ where x is unknown (the previous contents of the location).

On the second pass, the 0s are programmed, resulting in $x0x0 x0x0$ where x is a don't care state (in this case 1s from the first pass) so that the resulting value after both passes is $1010 1010$, the desired value. This method is effective for modifying short segments of code.

If a large segment of code is to be modified, it will reduce programming time by almost one half if you block erase to 1s and use the 0s-only mode.

When programming the EEPROM memory of TMS370 devices that also have UV-erasable EPROMS, be sure to block erase the array before programming the device. (Ultraviolet light causes the EEPROM bits to go to an intermediate so that they must be block erased before programming.)

2.7 Showing the Software Revision Information — the Show ID Command

This command displays the software release/revision information on the top line of the PC screen for reference. Press any key to return to the configuration command line.

2.8 Defining and Adding a Device to the Device Table—the Add Device Command

This command lets you define a new device type different from those in the current device table, and then add it to the device table. When the *add device* command is selected, the following programmer prompts appear.

Step 1: Identify the complete device name by answering the following two prompts:

Device family name:

Device first name:

Legal device family names supported by the programmers are TMS370, 2732, 2764, 27128, or 27256.

Device first names are names that distinguish different versions of the same device family.

The programmer software checks the device table to make sure the new device is not a duplication. If the new device is a duplicate, the following error message is displayed.

```
duplicate device name (hit any key)
```

Press any key to erase the error message and return to the first prompt to re-enter different device names.

Step 2: Identify the programming address range by answering the following two prompts:

```
Device Program Ranges - Start Address: 0000h
```

```
Device Program Ranges - Size: 0000h
```

Enter numerical values within the range (0000h–FFFFh) to the address prompts listed in Step 2.

Step 3: Identify the primary configuration parameters for the device by answering the following four prompts:

```
Type of Memory:
```

```
Device VCC(in VDC - 0, 5 or 6) : 0
```

```
Device VPP (in VDC - 0, 5, 12, 12.5 or 21): 0
```

```
Program Pulse Duration time (in ms - [0-127]): 0
```

Valid types of memory are EPROM or EEPROM.

Legal V_{CC} values are listed following the prompt—0, 5, or 6. If you enter a value that is not one of the three valid choices, the following error message appears:

```
invalid VCC value: 0, 5, or 6 (hit any key)
```

Press any key to erase the error message and return to the prompt to enter the V_{CC} value again.

Legal V_{PP} values are listed following the prompt—0, 5, 12, 12.5, or 21. If you enter a value which is not one of the five choices, the following error message appears:

```
invalid VPP value: 0, 5, 12, 12.5 or 21 (hit any key)
```

Press any key to erase the error message and return to the prompt to enter the V_{PP} value again.

Valid *pd*t values fall in the decimal range of 0–127 as shown at the end of the prompt. If you enter a value that is out of the range, an error message is displayed as follows:

```
invalid Program Pulse Duration time: [0..127]
```

Press any key to erase the error message and return to the prompt to enter the Program Pulse Duration time again.

Step 4: Identify the secondary configuration parameters by answering the following four prompts:

Control Register:

This parameter is necessary only for programming TMS370 micro-controllers. The current valid values are 01Ah for the data EEPROM range and 1Ch for the program memory range.

Family Code:

This parameter tells the programmer how to program the device. The current valid values are:

Code	Device	Code	Device
10h	TMS370 EEPROM range	41h	2764, 27C64, SE77C42, TMS77C82
11h	TMS370 EPROM range	42h	27C128
20h	TMS7742	43h	27C256
40h	2732		

Block Erase:

Using the block erase parameter for devices with a family code of 10h (TMS370 EEPROM range) allows the array to be erased to 1s or 0s. The block erase parameter is ignored for any other family code and should be set to *none* for clarity.

Program Algorithm:

If the family code is 10h (TMS370 EEPROM range), one of three programming algorithms can be chosen—*program 1s*, *program 0s*, or *program 1s and 0s*. Using this parameter along with the *block erase* parameter, you can optimize for programming speed or can minimize the number of write erase cycles. This parameter is ignored for any other family code and should be set to *program 0s only* for clarity.

After you have entered the program algorithm, the programmer repeats the setup configuration starting at Step 2 to allow you to enter up to five address blocks. Press **[ESC]** to exit the loop after you have entered all the address blocks you need. You must enter at least one set of *add device* parameters before exiting the command, or else the following warning message is displayed.

Device parameters not complete, device not added.

Press any key to erase the warning message and return to the configuration command menu.

After you have entered all of the above parameters correctly, the newly defined device is added to the current device table and displayed in the device table window.

2.9 Editing the Configuration Parameters and Device Table — the Edit Command

In the *edit* mode, you can edit the configuration *port #* parameter field and the current device table.

2.9.1 Editing the Configuration Parameters

From the configuration window press **[E]** for the edit command. Pressing **[F3]** toggles you between the port # field and the device table, while pressing **[SPACE]** in the port # field scrolls through the valid selections for the communication port—port 1, or 2.

Press the **[ESC]** key when you are finished editing the parameters to record your changes and to return you to the configuration command menu.

Note:

In order to edit any of the current device table parameters, you must display the parameters (show ranges) and then use the designated function key to edit the ranges window. Refer to subsection 2.9.2 for a complete description.

2.9.2 Editing the Device Table

The device table is a list of devices categorized by *family name* and *device first name*. The software diskette provides a device table file, *device.tbl*, that contains a list of devices and their configuration parameters. The devices and their configurations are loaded automatically when the programmer software is invoked.

Pressing **F3** from the *port #* field causes the cursor to enter the device table field. When this occurs, several function keys and their actions are displayed at the bottom of the screen. (Choosing *edit* from the command line will also place the cursor directly into the device table field if this field is the last one you worked in. In other words, the *edit* command defaults to the last field you were in before exiting back to the command line.) To edit the device table, use the commands listed in Table 2-4.

Table 2-4. Device Table Edit Commands

Command	Function
F1 (Page Down)	Scroll forward through device table.
F2 (Page Up)	Scroll backward through device table.
F3 (Next Window)	Move to the communication port.
F4 (Show Ranges)	Show the valid address ranges defined for the device highlighted by the cursor.
F5 (Select Device)	Select the device next to the cursor.
F6 (Delete Device)	Delete the device next to the cursor.
ESC (Escape)	Return to the configuration command menu.
↑	Move up one line, scrolling if necessary.
↓	Move down one line, scrolling if necessary.
Return Key	Accept the input value and move cursor to the next location on the same line.

If you press **F4**, a temporary window appears on the upper half of the screen (as shown in Figure 2-4) that shows all the parameters of the current device.

Figure 2-4. Valid Address Ranges Window

Valid address ranges for 2732/TMS2732A										
START	SIZE	TYPE	Vcc	Vpp	Pdt	CtrlReg	FmlyCode	BlkErase	Pbits	
00000h	1000h	EPROM	5	21	10	ooh	40h	NO	O's only	

In order to edit these configuration parameters, press **F3** (this function key changes from *next window* to *edit ranges* when the show ranges window is called.) Use the editing protocol as described in Section 2.4 and the parameter descriptions in Section 2.8 in order to customize these device parameters.

Pressing **ESC** causes this temporary window to disappear, and the previous window is resumed.

Pressing **F5** from the device table selects the device on the line where your cursor is positioned. The device you have chosen is highlighted when selected.

Pressing **F6** deletes the device on the line where your cursor is positioned. If the deleted device is the current device, there is no current device type, and you must select a new device from the device table.

2.10 Loading the Device Table and Configuration Parameters From a File — the Load Command

When you select the L command, a submenu displays options for choosing a file to load. The commands in this submenu are listed below; the letter that invokes the command is printed in bold type.

Command	Function
Device Table	Load a device table file.
Configuration	Load configuration parameters from a configuration/batch file.

Both load options prompt for only one parameter—the file to be loaded. If the file specified does not exist, an error message is displayed as follows:

```
Can not open file: <file name> (hit any key)
```

Press any key to erase the error message and return to the prompt to enter the correct file name.

If a file that is not a valid device table is specified, the following error message is displayed:

```
Invalid/Wrong device table file: <file name> (hit any key)
```

Press any key to erase the error message and return to the configuration command menu.

Loading the Device Table

Select this option to load the current device table from a file that you specify. The device table window is updated as the current device table is reloaded.

Load the Configuration Parameters

This option loads the configuration parameters, listed below, from the specified configuration file.

- Communication port
- Current device
- Device table

If the device table file is specified, it will be loaded as the current device table, and the device type specified in the configuration/batch file will be searched for in the table.

2.11 Selecting a Current Device — the Choose Device Command

The *choose device* command moves the cursor directly to the device table. Use the cursor control keys to move the cursor to the device you will be programming and press **F5** to select it. The selected device is highlighted. Pressing **ESC** returns you to the configuration command line.

A device must be specified before the software allows you to enter the display window.

2.12 Saving Configuration Parameters and the Device Table to a File — the Save Command

The *save* command allows you to save the current configuration parameters or device table to a specific file. The initial prompt after this command executes gives you the following two choices; the letter used to invoke the command is printed in bold type.

Command	Function
Device Table	Save the current device table in a file.
Configuration	Save the current configuration in a Configuration/Batch file

Both save options prompt for only one parameter—the filename to save the data into. The file you specify can be either an existing file or a new file. The contents of an existing file are erased before the save takes place. The following paragraphs describe each option in detail.

Saving the Device Table

Use this option to save the current device table in a file that you specify. The file can be loaded later through the *load device table* command or the configuration/batch file. If the current device table is empty, no file will be generated.

To prevent accidental overwriting of the default device table, the name *device.tbl* cannot be used for saving the current device table. If you wish to update the default device table, save it under another name and then use the DOS copy command to copy your new device table to *device.tbl*.

Saving Configuration Parameters

Use this option to save the current configuration in a file that you specify. The current configuration is the one defined in the load configuration section. If you have not selected a current device type, the following error message is displayed:

```
No device is selected, can not build the file
```

Press any key to erase the error message and return to the configuration command menu.

2.13 Showing the Display Window — the Display Command

When you choose the *display command*, the programmer software checks to see if a current device type has been selected. If you have selected a current device type, the programmer sets up the configuration and briefly displays the following message before returning to the top level command.

```
Set programmer configuration.....
```

If you have *not* selected a current device type, the following warning message is displayed:

```
Warning: Device not selected, unable to set up the programmer
```

Press any key to erase the warning; then, use the *choose device* command to select a current device. You cannot proceed to the display window until a valid current device has been selected.

2.14 Ending Your Current Session and Returning to DOS — the Quit Command

Use the *quit* command to exit the programmer software. Before the programmer software actually quits, you must confirm that this is what you want to do at the prompt:

```
Confirm:
```

Press to confirm that you really want to quit. Any other key is interpreted as a retraction of the quit command.

Chapter 3

Operating in the Display Window

This chapter describes the commands offered in the display window of the programmer's display.

The first part of this chapter explains how the command menus and function keys work; it also has a short section on entering information at the cursor prompt. *These sections are the same as the initial sections in Chapter 2; if you have already read these sections in Chapter 2, there is no need to read them in this chapter.*

The remainder of this chapter describes the operation of the display window and explains each display command, walking you through the interactive display prompts where applicable.

Section	Page
3.1 How the Command Menus Work	3-2
3.2 Using the Special Function Keys	3-3
3.3 What Happens If I Make an Error?	3-3
3.4 Understanding Your Input at the Cursor Prompt	3-4
3.5 Display Window	3-5
3.6 Filling a Block of PC Memory With a Value	3-8
3.7 Loading a COFF File Into PC Memory	3-9
3.8 Outputting a COFF File From PC Memory	3-10
3.9 Moving Blocks of PC Memory	3-12
3.10 Programming a Device From PC Memory	3-13
3.11 Showing and Operating Within Text File	3-17
3.12 Uploading a Device's Contents Into PC Memory	3-19
3.13 Verifying the Contents of a Device	3-22
3.14 Editing the Contents of PC Memory	3-26
3.15 Using the Master Mode Menu	3-27
3.16 Suspending the Program and Entering DOS	3-28
3.17 Quitting the Program and Exiting to DOS	3-28

3.1 How Command Menus Work

The interactive mode of the programmer is driven by command menus that are displayed on the top line of the screen. A command menu is a list of command names, each of which is displayed with one highlighted letter, usually the first character in the name. The highlighted letter is the key you use to invoke the command. You may type command letters in upper or lower case.

When you type a valid command letter, the programmer software clears the command line, displays the name of the selected command, and executes the command. Most commands require additional information, in which case the programmer either prompts for parameters or displays a submenu of commands.

Figure 3–1 shows the command menu structure. This figure is provided as a road map to the desired command(s).

Figure 3–1. Command Menu Structure

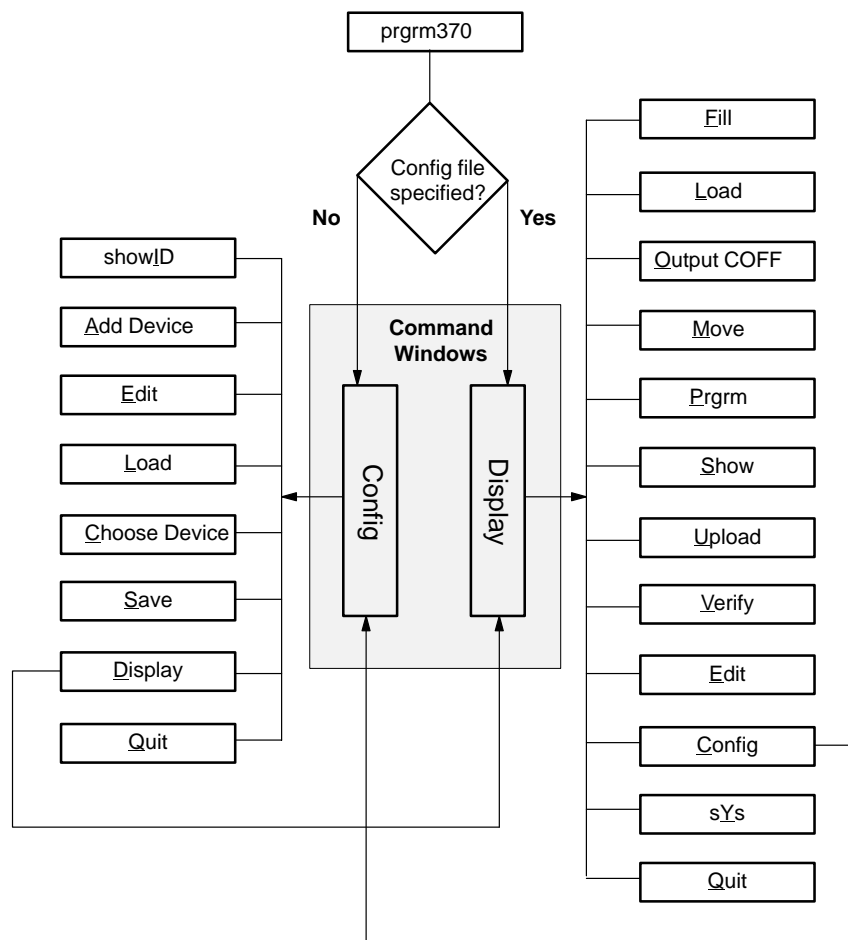

3.2 Using the Special Function Keys

Function keys **F1** through **F6** invoke various actions in the programmer, depending on your location in the command menu structure. The valid function keys and their definitions for each mode are displayed on the bottom line of the screen for reference. Press the highlighted key for the desired action.

Another special function key is **ESC**. If you ever need to abort a command and return to the next higher command menu level, press this function key. For example, if you are in the *fill memory* command, press **ESC** to return to the display command menu.

3.3 What Happens If I Make an Error

If an error occurs, the programmer software displays an error message on the bottom line of the screen and prompts you to *hit any key* to escape from the error state. You can type any key, including **ESC**, on the keyboard. The message is then cleared, and the function key line is redisplayed.

If the error was caused by an input to a prompt, the programmer software returns to the prompt to let you re-enter a value. Otherwise, the software returns to the next higher command menu.

To find an explanation of any error message, refer to Appendix 2.

3.4 Understanding Your Input at the Prompt

The programmer software often requires you to enter a response to a prompt or to move the cursor to a value on the screen and modify it.

The previous or default value for the prompted parameter value is always displayed. You can accept the displayed default or former value by pressing only  in response to the prompt.

If you type a new value, the characters are highlighted and the cursor advances to the next field position. *Only the highlighted characters are accepted by the programmer.* For example, assume that the displayed default value is 7020 (the underscored character indicates the cursor position). If you type 8 over the default value, you would see **8**020 on the screen (the boldface character indicates the highlighted character on the screen). If you then pressed the ENTER key, the value entered would be 0008, *not* 8020.

All numeric input values are hexadecimal except for the V_{CC} , V_{PP} , and program-pulse-duration-time values, which are decimal.



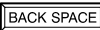



Table 3–1 lists special control keys. The effect of each key is given for both text and numeric fields. Any control key not listed in the table has the same effect as .

Table 3–1. Edit Control Keys

Key	Function
	Terminates input and accepts current value.
	Text: Inserts a space. Numeric: Terminates input and accepts current value.
	Text: Erases character to the left of cursor and backs up one space. Numeric: Erases character to the left of cursor and backs up one space.
	Text: Subsequently typed characters are inserted at the cursor position; characters to the right of the cursor are moved right, even out of the field. Remains in effect until the INSERT key or another control key is typed. Numeric: No effect.
	Text: Deletes character at cursor. Numeric: No effect.
	Text: Moves cursor left one space without erasing. Numeric: Moves cursor left one space without erasing.
	Text: Moves cursor right to the next character and highlights it. Numeric: Moves cursor right to the next character and highlights it.

3.5 Display Window Overview and Description

The **display window** has two separate areas (see Figure 3–2): the PC memory display (left half of screen) and the reverse assembled code (right half of screen).

The programmer displays the PC memory in a hexadecimal format. The memory address occupies the left-most column of each line, followed by eight bytes of PC memory contents. Next on the display line are eight characters that represent the PC memory contents as ASCII values. Nonprintable ASCII characters are represented by the . character.

The address range for the PC memory is from 0000h to FFFFh. Access to the PC memory out of this range is not allowed. The programmer maintains the array as a circular buffer so that any scrolling that exceeds the limits is wrapped around.

The reverse-assembled code window contains the disassembled code from the PC memory.

Figure 3–2. PC Memory Display and Reverse Assembled Code Windows

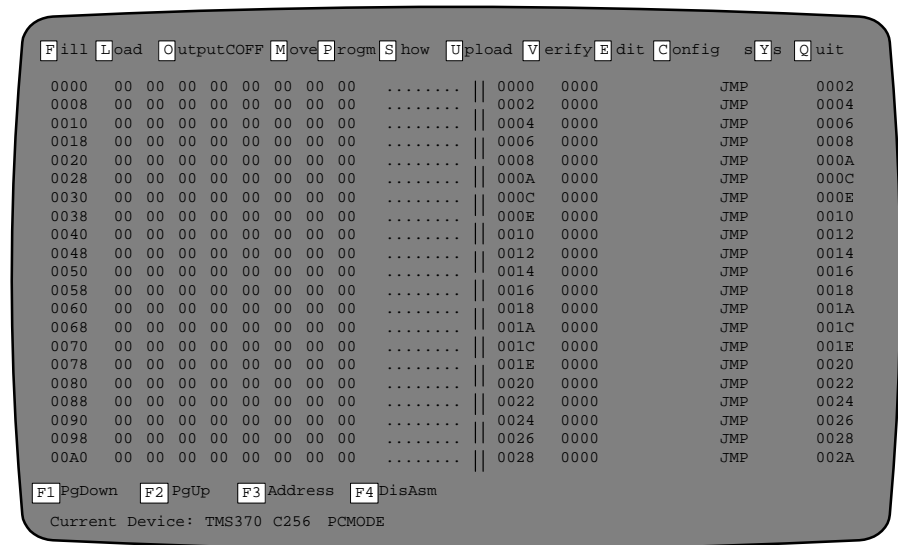

All the commands are described briefly in Table 3–2. A complete description of all display window commands can be found in Sections 3.6 through 3.17.



When you use the gang programmer, the BlankChk and mAster options are added to the command line.

Table 3–2. Display Window Commands

Command	Function
Fill Memory	Fill PC memory with a byte value.
Load COFF File	Load a COFF file to PC memory.
Output COFF File	Create a COFF file from PC memory.
Move Memory	Move a block of PC memory to another location in the PC memory.
Program Device	Program device from the PC memory.
Show File	Show a text file.
Upload Device	Upload device content to the PC memory.
Verify Device	Verify device from the PC memory.
Edit	Inspect and/or modify individual memory locations.
Config	Display a menu of commands to handle the configuration and device table.
sYs	Allow use of DOS commands and functions without exiting the programmer software.
Quit	Exit programmer software and returns to DOS.
F1 – PgDown	Scroll down through memory addresses.
F2 – PgUp	Scroll up through memory addresses.
F3 – Address	Allow choice of a specific memory address to inspect.
F4 – DisAsm	Inspect reverse assembly code window with scrolling.
ESC	Return to display window command line from any command.

A complete description of the function keys follows.

F1 **F2** The *scroll keys* allow you to scroll down or up through the memory addresses.

F3 The *address key* allows you to move to a specific address. When you press this key, you are prompted to supply an address, using the value at the current cursor position as a default. Legal addresses are in the range from 0000h to FFFFh.

F4 The *disassembler key* allows you to inspect the reverse-assembled code window. The display is the same as the code window of the TMS370 XDS Debugger, except that the display is not symbolic and the code is disassembled from the PC memory instead of the emulator memory.

Table 3–3 describes the commands, functions, and control keys for inspecting this window. The keys used to invoke the commands are printed in bold type.

Table 3–3. Reverse Assembled Code Window Commands

Command	Function
F1 (Pg Down)	Scroll forward through code.

F2 (Pg Up)	Scroll backward through code.
F3 (Address)	Invoke disassembler at specified PC memory address.
ESC	Leave inspect mode and return to display command menu.
←	Move cursor left one space.
→	Move cursor right one space.
↑	Move up one line, scrolling if necessary.
↓	Move down one line, scrolling if necessary.

The programmer can not disassemble backwards through the PC memory. For this reason, you cannot scroll up past the lowest address that was used when the virtual buffer was initially filled with disassembled code.

If you scroll down past the limit of the buffer, the buffer wraps around, and you will not be able to scroll back to the original starting address. If you get into this predicament, use the *address*, **[F3]**, command to invoke the disassembler at any address you specify. The second line on the code window screen displays the address at the current cursor position.

3.5.1 Differences in Command Structures for Microcontroller Programmer and Gang Programmer

Because of certain hardware differences between the two different types of programmers described in this documentation, some of the display window commands operate slightly differently depending on which programmer you are using. As in the Installation section of this book, **icons** are used to distinguish between the steps or prompts that are specific to one programmer or the other. If there are no icons, you can assume the command is the same for all programmers.



This icon is used to show steps specific to the microcontroller programmer.



This icon is used to show steps specific to the gang programmer.



The icons are used together to show the continuation of one programmer's command and the start of the other programmer's command.

3.6 Filling a Block of PC Memory With a Value — the Fill Command

Use the **fill** command to fill a block of PC memory with a value.

Step 1: Define the size of the block by answering the following two prompts:

```
Fill Start Address: 0000h
```

```
Size (in bytes) : 0000h
```

Enter the start address in the range (0000h–FFFFh). Otherwise, an error message is displayed as follows:

```
FILLPC start address out of bound (hit any key)
```

Press any key to erase the error message and return to the display command menu.

At the second prompt, enter the number of bytes from the start address you want to fill. If the end address of the fill block (i.e., start address + size – 1) is out of the legal range, an error message is displayed as follows:

```
FILLPC end address out of bound (hit any key)
```

Press any key to erase the error message and return to the display command menu.

Step 2: Supply a value to be filled in the memory range defined in Step 1.

```
Fill value: 00h
```

Enter a hexadecimal value within the range (00h–FFh). If an out-of-range fill value is given, an error message is displayed as follows:

```
<FILLPC> Fill value out of range - (00h..FFh) (hit any key)
```

Press any key to erase the error message and return to the display command menu.

If all three parameters are entered correctly, the programmer fills the specified block of PC memory with the given value and displays them on the dump window.

When you program EPROM memory, it is often best to fill the memory range with the value FFh before loading the object file. This prevents unused bytes from being programmed, and this decreases programming time.

3.7 Loading a COFF File Into PC Memory—the Load Command

Use the **load** command to load a COFF file into the PC memory. This command allows you to load the entire COFF file or part of it and also to specify where in the PC memory you want it loaded.

Step 1: Identify the COFF file you want to load at the following prompt:

```
Object file:
```

If the file does not exist, an error message is displayed. Press any key to erase the error message and return to the prompt to enter the correct name.

If the file is not recognized as a TMS370 object file, another error message is displayed. You will be asked if you want to load the file anyway. Note that trying to load a file that is not in COFF format may cause your PC to hang.

Step 2: To identify the amount of the COFF file you want loaded, specify the object (COFF file) address range.

```
Object base address: all
```

```
Size (in bytes) : 0000h
```

The default for the base address is *all*, which means to load the entire COFF file into the PC memory. The addresses specified in the COFF file are also used as the loading addresses for the PC memory. If the default *all* is selected, the programmer loads the COFF file into the PC memory without prompting you for anything else.

If, however, you want to load part of the COFF file, replace the default *all* with a start address to specify where in the COFF file you want to start loading. Then, enter the number of bytes you want to load from the COFF file. All the data bytes in the COFF file that are inside the given range are loaded to the PC memory. If the entered load range is outside the legal PC memory address space, the entered range is truncated to the legal range. For example, if you entered F000h as the object base address and 2000h as size, the programmer will truncate the range and use F000h–FFFFh) as the load range.

Step 3: Specify the PC base address when you load only part of a COFF file.

```
PC Memory base address:<the input from prompt (2)>
```

The default for this prompt is the input you have given for the object base address prompt. If you want to load at a different location, enter the PC memory address for the load. Also, the PC memory address you enter here must be in the PC memory address space.

Once you have entered all the parameters correctly, the programmer loads the COFF file into the PC memory.

3.8 Outputting a COFF File From PC Memory — the Output COFF Command

Use the **output COFF** command to create a COFF object file from the PC memory. This command allows you to specify the block(s) of PC memory to be used to create the COFF file. Each block of the PC memory is made into one section in the COFF file, and you can specify the section address in the COFF file to use for the block.

Step 1: Identify the file for the COFF output.

COFF Object file:

The name can be any valid DOS file name.

Step 2: Identify the address range you want to output by specifying the object (COFF file) address range.

PC Memory base address: `all`

The default for this base address prompt, `all`, causes the valid address ranges defined for the current device type to be used as block(s) of PC memory. These blocks are used to create the COFF file.

For example, the valid address ranges for a TMS370C756 device are (1E00h–1FFFh) and (4000h–7FFFh). If you use the default for this prompt, the PC memory inside those two ranges is used to create two sections in the COFF file with section addresses 1E00h and 4000h, respectively.

If, however, you want to use blocks of PC memory other than the default, enter a PC memory address instead of the default `all`, and then enter the size of the block at the prompt:

Size (in bytes) : `0000h`

The PC memory block that you specify must be inside the PC memory address space. Otherwise, an error message is displayed when an out-of-bounds error is detected. Press any key to erase the error message and return to the prompt to re-enter the value.

Step 3: Specify the COFF object base address when using memory space other than the default.

COFF object base address:

The default for this prompt is the value given for the PC memory base address prompt. If you want to use a different address in COFF for the block, enter an address here.

After you answer this prompt, the programmer returns to Step 2 to ask for another PC memory base address. If you have specified all the desired PC memory blocks, press `ESC` to terminate the input session. If you need more PC memory blocks, continue repeating the address prompts until a maximum of five blocks of PC memory have been entered.

After the input session is completed, the programmer uses the PC memory blocks given to create the COFF file.

As a result of debugging, you may have made code changes that you would like to save. You can save the changes for later use by creating a COFF file from the working code in the PC memory. You may specify the range(s) of the source to be read or you can use the valid address ranges defined for the current device type.

Each range of the source read is written as one section in the COFF file. The section address for the created section can be either the default address or another address that you specify. For example, you can create a COFF file from device location 7000h to 7FFFh with a section address 0000h in the COFF file. Refer to the *TMS370 Family Assembly Language Tools User's Guide* for more information on COFF files. The COFF file created by the programmer does not have the symbolic information that would be available after an assembly.

3.9 Moving Blocks of PC Memory—the Move Command

Use the **move** command to move a block of PC memory from one location to another PC memory location.

Step 1: Identify the size of PC memory to be moved.

```
Move PC memory From Address: 0000h
Size (in bytes) : 0000h
```

Enter the start address of the block to be moved and then enter the size of the block to be moved.

Step 2: Specify a destination address where the block of memory is to be moved.

```
Move to PC memory Address: 0000h
```

The source block and destination block that you specify must be inside the PC memory address space. Otherwise, one of the following error messages is displayed:

```
<MOVEPC> source start address out of bound
<MOVEPC> source end address out of bound
<MOVEPC> destination start address out of bound
<MOVEPC> destination end address out of bound
```

If the source block and destination block overlap, the programmer automatically makes sure that no data is overwritten before it is moved.

After you have entered all the parameters correctly, the programmer moves the block of PC memory to the destination and displays the destination PC memory.

3.10 Programming a Device From PC Memory — the Program Command

When you use the **program** command, the microcontroller and gang programmers display different prompts and messages. The microcontroller programmer is discussed in sub-section 3.10.1, and the gang programmer is discussed in subsection 3.10.2.

3.10.1 Programming Using the Microcontroller Programmer



Use the microcontroller programmer's *program* command to program a device from the PC memory with verification.

Step 1: Define an error file for verification output (if any):

```
Error file:
```

The last entered file will appear as a default.

Step 2: Identify the address ranges used to program the device.

```
PC memory base address: all
```

The default for the base address, *all*, causes the valid address ranges defined for the current device type to be used as the blocks of PC memory for programming the device. The valid address ranges also tell where in the device to program the PC memory block(s).

However, if you want to program a device from a certain block of PC memory other than the default, enter the start address of the block and then the size of the block at the next prompt.

```
Size (in bytes) : 0000h
```

When specifying values other than the default, you must also define the device's base address at the following prompt.

```
Device base address:
```

The default for this prompt is the value entered for the PC memory base address prompt. If you want to program at a different location, enter the address at which programming is to start.

Once the programming begins, it proceeds packet by packet in 180-byte segments. Before a packet is programmed, the programmer verifies that the destination device address is inside the valid address ranges defined for the current device type. If the address is not inside the range, the following error message is displayed.

```
Address out of range, Press any key
```

During the programming process, the programmer displays a status message on the bottom line to indicate the address currently being programmed.

```
Programming at address 7000 (hit ESC key to abort)
```

This message is updated when the programmer starts programming the next packet.

If, for some reason, you want to terminate the programming process before it is completed, press the **ESC** key to abort the process and return to the display command menu.

When the programming process is either completed or aborted, a message informs you whether or not the programming was successful. The message for successful programming is:

```
Programming Complete, Program another device?(y/n)
```

If you want to program another device using the same parameter values, replace the device in the programmer with the new one and press **Y**.

The message for an unsuccessful programming operation is:

```
Error occurred during programming. (hit any key)
```

Press any key to erase the error message and return to the display command menu. Use the *show* command to look at the error file and find the error location(s).

Automatic verification takes place during the programming. The programmer reads, from the device, data bytes just programmed and compares them with the source data bytes. If the data bytes are not programmed correctly, an error file is generated. Both the source and the read-back values of the data bytes are included in this file. An error file is not generated if no errors have occurred during programming. The format of the error file is illustrated below.

TMS370 EEPROM Programmer v3.20		
Verification output by byte:		
Address	Byte Value (downloaded)	Byte Value (read back)
7070	b4	ff

In the example above, the device location 7070h should have been programmed with value *B4h*, but the value read back from the device is *FFh*.

3.10.2 Programming Using the Gang Programmer



In PC mode, use the gang programmer's *program* command to program multiple devices from the PC memory with verification. (For information on programming from standalone mode, refer to subsection 1.2.2 on page 1-6.) Starting the programming is a simple one-step process of defining PC memory and device address ranges.

Step 1: Identify the address ranges of PC memory used to program the device.

```
PC memory base address: all
```

The default for the base address, *all*, causes the valid address ranges defined for the current device type to be used as the blocks of PC memory for programming the device. The valid address ranges also tell where in the device to program the PC memory block(s).

However, if you want to program a device from a certain block of PC memory other than the default, enter the start address of the block and then the size of the block at the next prompt.

```
Size (in bytes) : 0000h
```

When specifying values other than the default, you must also define the device's base address at the following prompt.

```
Device base address:
```

The default for this prompt is the value entered for the PC memory base address prompt. If you want to program at a different location, enter the address at which programming is to start.

After you have entered all the parameters correctly (or simply chosen *all* at the PC memory base address prompt), the gang programmer conducts a device test. If any devices fail (or any sockets are empty), the programmer beeps and turns on the LED below the failed device. Also, an error message prompts you about the device failure:

```
Device test failed, continue? (y/n)
```

If only empty sockets failed, press to begin the programming. If any devices actually failed, try to re-insert these devices and start the programming over.

It is possible that a defective device—a device with bent pins or a device that has been incorrectly inserted—will affect all of the devices on the Gang programmer. If this is the case, the following error message is displayed:

```
unable to communicate with TMS370 device - Retry, Abort
```

You should inspect all of the devices for misalignment or bent pins. You may have to remove devices until the bad device is found.

Once the programming begins, it proceeds packet by packet in 180-byte segments. Before a packet is programmed, the programmer verifies that the destination device address is inside the valid address ranges defined for the current device type. If the address is not inside the range, the following error message is displayed.

```
Address out of range, Press any key
```

During the programming process, the programmer displays a status message on the bottom line to indicate the address currently being programmed.

```
Programming at address 7000 (hit ESC key to abort)
```

This message is updated when the programmer starts programming the next packet.

If, for some reason, you want to terminate the programming process before it is completed, press the key to abort the process and return to the display command menu.

If an error is detected during programming, the red LED below that device is turned on. At the end of the programming process, only those devices whose LED is off have been programmed properly. If you want to examine the locations that failed to program, you must create an error file by using the verify command found in Section 3.13 on page 3-22.

When the programming process is complete, the programmer beeps, and the following message is displayed:

```
Programming Complete, Program another device?(y/n)
```

If you want to program more devices using the same parameter values, replace the device(s) in the programmer with the new one(s), and press .

3.11 Showing and Operating Within a Text File—the Show Command

Use the **show** command to show a text file. This command uses the entire screen below the second line as the file display window. When you select the show command, the programmer prompts for a file name:

File:

Type the pathname of the file to be displayed. If the file exists, the programmer displays the first lines of it on the screen.

The maximum size of a file that can be displayed is 2048 lines. Any file larger than this is truncated to 2048 lines. The maximum file size is also limited by available memory because the entire file is PC memory-resident.

Table 3–4 gives the commands, functions, and control keys available for inspecting the text file. The letters used to invoke the command are printed in bold type.

Table 3–4. Show Text File Commands

Command	Function
Find	Find a character string.
Find Next	Find the next occurrence of the string.
Line No.	Move to the specified line number.
Top	Move to top of file.
Bottom	Move to end of file.
ESC	Leave inspect file mode and return to the display command menu.
←	Move cursor left one space, scrolling if necessary.
→	Move cursor right one space, scrolling if necessary.
Control/←	Move to beginning of line.
Control/→	Move to end of line.
Insert	Scroll window left.
Delete	Scroll window right.
↑	Move up one line, scrolling if necessary.
↓	Move down one line, scrolling if necessary.

When you inspect the file, the second line on the screen displays the name of the file, the current line number, and the total number of lines in the file.

Example:

```
"file.txt" line 113/355
```

3.11.1 Finding Character Strings Within a Text File — the Find Command

The *find* command allows you to search for a string of characters in the text file. When the programmer prompts you for a character string, type a string up to 30 characters long. The programmer begins at the current position and searches for the string.

If the programmer reaches the end of the file without finding the string, it wraps around to the beginning of the file and searches from there to the original cursor position.

If the string is not found anywhere, the cursor simply remains in its current position. If the string is found, the window is scrolled if necessary, and the cursor is moved to the start of the target string.

3.11.2 Finding the Next Occurrence of Character String — the Next Command

With the *next* command you can search for the next occurrence of a string that was previously found with the find command. When you select the next command, the programmer begins one space past the cursor position and begins searching for the same string that was used by the most recent find command. The search proceeds exactly as in the find command. If no find command has been used, the cursor does not move.

3.11.3 Positioning the Cursor at a Specific Line Number — the Line Command

The *line* command allows you to move to a specified line number in the file. The programmer prompts you for the line number, with the current line as the default.

Enter either an absolute line number or a relative offset from the current line. If you type a + or – in front of the number, the offset is relative, the direction indicated by the plus or minus. The programmer positions the cursor at the specified line number, scrolling the window if necessary.

3.11.4 Positioning the Cursor at Top of a File — the Top Command

Use the *top* command to position the cursor on the first line of the file, scrolling the window if necessary.

3.11.5 Positioning the Cursor at the Bottom of a File — the Bottom Command

Use the *bottom* command to position the cursor on the last line of the file, scrolling the window if necessary.

3.12 Uploading a Device's Contents Into PC Memory– the Upload Command

When you use the **upload** command, the microcontroller and gang programmers display different prompts and messages. The microcontroller programmer is discussed in sub-section 3.12.1, and the gang programmer is discussed in sub-section 3.12.2.

3.12.1 Uploading Using the Microcontroller Programmer



Use the *upload* command to upload the device contents to the PC memory. Starting the upload is a simple one-step process of defining PC memory and device address ranges.

Step 1: Define the address range of the device contents you are uploading.

```
Device base address: all
```

The default for the base address prompt, *all*, causes the valid address ranges defined for the current device type to be read and uploaded to the PC memory.

For example, the valid address ranges defined for the TMS370C756 device are (1E00h–1FFFh) and (4000h–7FFFh). When the default is used, the contents of the device inside (1E00h–1FFFh) and (4000h–7FFFh) are read and uploaded to PC memory starting at address 1E00h and 4000h, respectively.

However, if you want to upload device contents from a range in the device other than the default, enter the start address of the range and then the size at the next prompt.

```
Size (in bytes): 0000h
```

When specifying values other than the default, you must also define the PC memory base address at the following prompt.

```
PC memory base address:
```

The default for this prompt is the value entered for the device base address prompt. If you want to upload to a different PC memory location, enter the address.

Once the actual uploading begins, it proceeds packet by packet in 180-byte segments. Before a packet is uploaded, the programmer verifies that the source device address is inside the valid address ranges defined for the current device type. If the address is not inside the range, the following error message is displayed:

```
Address Out of Range, Press any key
```

Press any key to erase the error message and return to the display command menu.

During the uploading process, the programmer displays a status message on the bottom line of the screen to indicate the address currently being read.

```
Reading at address 7000 (hit ESC key to abort)
```

This message is updated when the programmer starts to upload the next packet.

If you want to terminate the uploading process before it has completed, press  to abort the process and return to the display command menu.

3.12.2 Uploading Using the Gang Programmer



Use the *upload* command to upload the device contents to the PC memory.

Step 1: Identify the device you wish to upload.

```
Enter Device #[1...16]
```

Step 2: Define the address range of the device contents you are uploading.

```
Device base address: all
```

The default for the base address prompt, *all*, causes the valid address ranges defined for the current device type to be read and uploaded to the PC memory.

However, if you want to upload device contents from a range in the device other than the default range, enter the start address of the desired range and then its size at the next prompt.

```
Size (in bytes): 0000h
```

When specifying values other than the default, you must also define the PC memory base address, that the contents of the device will be loaded into, at the following prompt.

```
PC memory base address:
```

After you have entered all the parameters correctly (or simply chosen *all* at the PC memory base address prompt), the gang programmer conducts a device test. If the device specified fails (or that socket is empty), the programmer beeps and turns on the LED below the failed device. Also, an error message prompts you about the device failure:

```
Device test failed, continue? (y/n)
```

At this time, you should try to re-insert the failed device and start uploading its contents again.

It is possible that a defective device—a device with bent pins or a device that has been incorrectly inserted—will affect all of the devices on the Gang programmer. If this is the case, the following error message is displayed:

unable to communicate with TMS370 device - Retry, Abort

You should inspect all of the devices for misalignment or bent pins. You may have to remove devices until the bad device is found.

Once the actual uploading begins, it proceeds packet by packet in 180-byte segments. Before a packet is uploaded, the programmer verifies that the source device address is inside the valid address ranges defined for the current device type. If the address is not inside the range, the following error message is displayed.

Address out of range, (press any key)

Press any key to erase the error message and return to the display command menu.

During the uploading process, the programmer displays a status message on the bottom line of the screen to indicate the address currently being read.

Reading at address 7000 (hit ESC key to abort)

This message is updated when the programmer starts to upload the next packet.

If you want to terminate the uploading process before it has completed, press  to abort the process and return to the display command menu.

3.13 Verifying the Contents of a Device – the Verify Command

When you use the **verify** command, the microcontroller and gang programmers display different prompts and messages. The microcontroller programmer is discussed in sub-section 3.13.1, and the gang programmer is discussed in subsection 3.13.2.

3.13.1 Verifying Using the Microcontroller Programmer



The *verify* command compares the contents of the device with the contents of the PC memory. If any data byte in the device does not match the corresponding data byte in the PC memory, this function generates a verification output file.

Step 1: Specify the error file for the verification output (if any).

```
Error file:
```

If you have entered an error file previously, it will appear as a default.

Step 2: Identify the address range of the content you want verified.

```
PC memory base address: all
```

The default for the base address, *all*, means to use the valid address ranges defined for the current device type as the blocks of PC memory for verification. The valid address ranges also determine the locations in the device from which the data bytes are read.

However, if you want to verify the device from a block of PC memory other than the default, enter an address to specify the start address of the block. Then enter the size of the block at the next prompt.

```
Size (in bytes): 0000h
```

When specifying values other than the default, you must also define the device base address, where the verification should begin, at the following prompt.

```
Device base address:
```

The default for this prompt is the value entered for the PC memory base address prompt. If you want to read from a different device location, enter the new address here.

After you have entered all of the parameters correctly, the programmer starts reading the data bytes from the device and comparing them with the data bytes in PC memory.

If any inconsistent data bytes are detected, they are written to the error output file. The verification proceeds packet by packet (180-byte segments). Before the programmer reads a packet of data bytes, it verifies that the source device address to be read from is inside the valid address ranges defined for the cur-

rent device type. If the address is not in the range, the following error message is displayed.

```
Address out of range, Press any key
```

During the verification process, the programmer displays a status message on the bottom line to indicate the beginning address of the packet currently being programmed.

```
Reading at address 7000 (hit ESC key to abort)
```

This message is updated when the programmer starts to verify the next packet.

If, for some reason, you want to terminate the verify process before it is completed, press the ESC key to abort the process and return to the display command menu.

When the verification process is either completed or aborted, a message informs you whether or not the verification was successful. The message for successful verification is:

```
Verification Complete, verify another device?(y/n)
```

If you want to verify another device using the same parameter values, replace the device in the programmer with the new one and press Y.

The message for an unsuccessful verification is:

```
Error occurred during verification. (hit any key)
```

Press any key to erase the error message and return to the display command menu. Use the *show* command to look at the error file and find the error location(s).

3.13.2 Verifying Using the Gang Programmer



The *verify* command verifies the contents of one or more devices with the contents of PC memory or against a master EPROM. If you verify a single device against PC memory and the verification fails, this function generates a verification output file.

Step 1: Identify the source of the verification. That is, master device or PC memory. For more information about master EPROM devices, refer to Section 1.2 on page 1-4.

```
Enter source [M]aster or [P]C
```

If master is chosen, the memory ranges are determined from the master EPROM.

Step 2: Enter which device(s) are going to be verified.

```
Enter Device #[1...16] or [A]ll
```

Step 3: If you chose to verify a single device against PC memory, you must now specify the error file. Otherwise, verification errors are indicated with the red LEDs found below each device socket. If you have entered an error file previously, it will appear as the default.

Error File:

Step 4: If you are verifying against PC memory, you must select the address range to be used during verification.

PC memory base address: all

The default for the base address prompt, *all*, causes the valid address ranges defined for the current device type to be used as the blocks of PC memory for verification. The valid address ranges also determine the locations in the device from which the data bytes are read.

However, if you want to verify the device from a block of PC memory other than the default, enter an address to specify the start address of the block. Then enter the size of the block at the next prompt.

Size (in bytes): 0000h

When specifying values other than the default, you must also define the device base address, where the verification should begin, at the following prompt.

Device base address:

The default for this prompt is the value entered for the PC memory base address prompt. If you want to read from a different device location, enter the new address here.

After you have entered all the parameters correctly (or simply chosen *all* at the PC memory base address prompt), the Gang programmer conducts a device test. If the device you have chosen fails (or any sockets are empty) the programmer beeps and turns on the LED below the failed device. Also, an error message prompts you about the device failure:

```
Device test failed, continue? (y/n)
```

At this time, you should try to re-insert the failed device and start verifying its contents again.

It is possible that a defective device—a device with bent pins or a device that has been incorrectly inserted—will affect all of the devices on the gang programmer. If this is the case, the following error message is displayed:

```
unable to communicate with TMS370 device - Retry, Abort
```

You should inspect all of the devices for misalignment or bent pins. You may have to remove devices until the bad device is found.

Once the actual verification begins, it proceeds packet by packet (180-byte segments). Before a packet is read, the programmer verifies that the source device address is inside the valid address ranges defined for the current device type. If the address is not inside the range, the following error message is displayed.

```
Address out of range, (press any key)
```

Press any key to erase the error message and return to the display command menu.

When verifying against PC memory, the programmer displays a status message on the bottom line of the screen to indicate the address currently being read.

```
Reading at address 7000 (hit ESC key to abort)
```

This message is updated when the programmer starts to upload the next packet.

If you want to terminate the uploading process before it has completed, press to abort the process and return to the display command menu.

When you verify a single device against PC memory and the process is completed, a message informs you whether or not the verification was successful. The message for successful verification is:

```
Verification Complete, verify another device?(y/n)
```

If you want to verify more devices, in the same or different sockets, using the same parameter values, press .

3.14 Editing the Contents of PC Memory—the Edit Command

The **edit** command puts the programmer in a special mode that allows you to overwrite the contents of the PC memory by typing new values.

When you press **[E]**, the cursor moves into the PC memory display area. You can scroll up and down through the PC memory with the cursor and function keys, and modify individual bytes.

The value at the cursor location is highlighted to indicate that you can edit it. Type the new value in hexadecimal. Use the normal movement keys (arrows, space bar) to write the new value and move to the next location, or press the **[ESC]** key to leave the edit mode.

The table below summarizes the commands, contrl keys, and functions available while in the display window edit mode.

Table 3–5. Display Window Memory Edit Commands

Command	Function
F1 (Pg Down)	Scroll forward through PC memory.
F2 (Pg Up)	Scroll back through PC memory.
F3 (Address)	Dump PC memory at specified address.
F4 (DisAsm)	Disassemble using current position as starting address.
ESC	Accept value, leave Edit mode, and return to display command menu.
←	Move cursor to previous location.
→	Move cursor to next location.
↑	Move up one line, scrolling if necessary.
↓	Move down one line, scrolling if necessary.
Space Bar	Move cursor to next location.
Return Key	Accept value and move to next location.
Tab Key	Move forward 4 locations.
Shift/Tab Key	Move backward 4 locations.
Control / ←	Move to beginning of line.
Control / →	Move to end of line.

In the edit mode, the second line of the display window contains the address of the cursor location and the 16-bit value that is stored there. It is this address that is used as the address for the F4 (disassemble) function. For example:

```
[101F] = F26E,
```

where F26E is the contents of memory location 101F.

3.15 Using the Master Mode Menu—the Master Command



The **master** command mode allows you to program and manipulate data with a master device as the source of the data manipulation. This command brings up a menu similar to the display window command menu. All the commands, **except program, upload, and copy**, work identically to the display window commands; however, the operations are performed on the master device only. The differences among the program, upload, and copy commands are described below:

Program The program command allows you to program a *blank* master device. You are prompted for address ranges, just as you are with the display window program command. After programming the ranges, the programmer programs the header information into the first 256 bytes of the master device. The programmer then calculates and programs the checksum into the last byte of header information.

Upload The upload command has two options—*data only* or *configuration and data*.

Data only allows you to load the data specified by the master device header information but does not upload the header information.



Configuration and data replaces the currently selected device information with the header information from the master device and also uploads the programmed data of the device. The device that was chosen in the configuration window is no longer valid. Before you return to the configuration window, you will be prompted to see if you would like to add the new configuration that was uploaded to the device table.

Copy The copy command copies the defined ranges from the master EPROM to all 16 devices. The necessary data should have been previously programmed in the master device using the program command in to the master menu. Because the copy is done in firmware without software intervention, no message showing the address being programmed is seen on the PC screen.

3.16 Suspending the Program and Entering DOS—the System Command

The **system** command temporarily suspends the programmer software so that you can use DOS commands and functions. When you are ready to leave DOS and return to the programmer software, enter EXIT and press .

3.17 Quitting the Program and Exiting to DOS—the Quit Command

The **quit** command exits the programmer software and returns to DOS. The programmer prompts you to confirm the command by entering  and a .

Appendix A

Operating the Programmer in Batch Mode

In the batch control mode, the execution flow is defined in a configuration/batch file, and all messages are displayed in line-oriented mode. The configuration/batch file consists of a set of commands that define the current configuration and give direction of execution.

Section	Page
A.1 Understanding the Batch Mode File	A-2
A.2 Batch File Command Rules and Descriptions	A-3
A.3 Batch Mode Status Messages	A-5

A.1 Understanding the Batch Mode File

Batch mode allows you to program and/or verify devices repeatedly with a fixed configuration setup in the configuration/batch file. When you invoke the programmer in batch mode, all device parameters are specified by the device type called out in the configuration/batch file.

The configuration/batch file is an ASCII file that calls out the device table and device type. You can create a configuration/batch file by using an editor or by using the *save configuration* command in the interactive mode. A single file can be used as either a configuration file or a batch file. If the programmer is invoked with the `-b` option, it is invoked in batch mode, and the executable commands are executed. If the `-b` option is not specified, the file is used to set-up the configuration, and all executable commands are ignored.

Example A-1 shows a configuration/batch file with comments explaining the purpose of each line.

Example A-1. Example Configuration/Batch File

```
DT=dev220.tbl      ;Use device table 'dev220.tbl'.
DV=tms370@C756    ;Device family is 'tms370', device
                  ;first name is 'C756'.
o=test.out        ;Use COFF file 'test.out'.
PO=1              ;Use communication port 1.
```

If you want to use this file as a batch control file, you must add batch commands to control programmer operation. Details about the valid batch commands are explained in Section A.2.

A.2 Batch File Command Rules and Descriptions

The batch commands can be classified as *executable* or *nonexecutable*. The executable commands invoke operations, whereas the nonexecutable commands define programming parameters and the device type.

The batch commands must conform to the following basic syntax rules:

- 1) Lower case and upper case characters are not distinguished.
- 2) Only one command is allowed on each line.
- 3) An = is required between a command and its operand if the command has an operand.
- 4) No spaces are allowed between a command and its operand.
- 5) No leading spaces are allowed on a command line.
- 6) Comments are indicated by a ; in front of the comment text.

If any of the above rules are violated, or if a nonexistent command or file is specified in a configuration/batch file, an error message is displayed after the file has been invoked.

A.2.1 Executable Batch Commands

There are three executable commands:

- PR** Program and verify device(s).
- VE** Verify device(s).
- R** Do device check on all device (gang programmer only).

Use only one of the commands, PR or VE, in a batch file. If both are specified, only the PR command is executed.

Make sure that the data ranges in the COFF file are a subset of the ranges in the device selected. The programmer attempts to program all the data ranges of the specified COFF file, regardless of the device ranges defined in the device table. To eliminate extra data ranges (ranges that would be later programmed in an external EPROM, for example) from the COFF output file, mark them as NOLOAD in the link command file. Refer to the *TMS370 Assembly Language Tools User's Guide* for more information on the linker and the NOLOAD section type.

In the normal mode, the entire data range defined for the selected device is usually programmed, and in the batch mode only the data range defined in the output file is programmed. Therefore, it is possible that a device programmed in batch mode will not verify correctly in the normal mode; the bytes failing verification are unused memory. To avoid this problem, always start with erased devices, and always fill memory with FFh before loading a file in normal mode.

No error file is created when you program or verify in batch mode with the gang programmer. Errors are indicated by the red LED below the failed device.

A.2.2 Nonexecutable Batch Commands

Nonexecutable commands do not invoke any action. They set certain programming parameters and define the device type. These commands can be classified as *defaultable* or *nondefaultable*. Defaultable commands are not *required* in the configuration/batch file; the commands have their own default values if not specified. Nondefaultable commands must be specified in the configuration/batch file because no default is provided.

Defaultable Commands

DT = <i>device table file</i>	Specify a <i>device table file</i> to be loaded as the current device table. The default is the manufacturer-supplied file <code>device.tbl</code> .
E = <i>error output file</i>	Direct the verification output (if any) to <i>error output file</i> . The default is the COFF file name specified with its extension replaced by <code>.err</code> . For example, the COFF file <code>a.out</code> will have a default error file <code>a.err</code> . (This command is ignored when you are using the gang programmer.)
O = <i>COFF file</i>	Specify the COFF file that will supply the data used to program/verify the device. If a COFF file is specified in the invocation command line, it takes precedence over the configuration/batch file.
PO = <i>comm port number</i>	Specify the PC communication port to be used. The default is port #1. The choices for <i>comm port number</i> are 1, or 2.

Nondefaultable Command

DV = *device family @ device first name*

This command specifies the device type to be used for the program/verify operations. The choices for *device family* are TMS370, 2732, 2764, 27128, 27256, or 7742. The *device first name* is any name defined in the current device table.

The device type *must* be specified before any action can be performed on the device.

A.3 Batch Mode Status Messages

When programming begins, a status message informs you:

```
Programming at device address
```

where *device address* is the location on the device that is currently being programmed. This message is updated every time the programmer starts on the next packet of data. A similar message appears when verification begins:

```
Reading at device address
```

where *device address* is the location on the device that is currently being read and verified. This message is updated every time the programmer starts verifying the next packet of data.

Upon completion of the batch execution, a message appears, informing you of the completion status.

If the operation was to program the device and was successful, the completion message is as follows:

```
Programming completed without errors
```

If the operation was to program the device but failed, the message is as follows:

```
Errors found during programming, see error file
```

where *error file* is the file specified for the verification output.

If the operation was to verify the device and was successful, the completion message is as follows:

```
No errors found during verification
```

If the operation was to verify the device but failed, the message is as follows:

```
Errors found during verification, see <error file>
```

If the configuration/batch file contains any commands that are not recognized by the programmer, the following message appears, and programming is aborted:

```
Invalid batch command: unknown
```

where *unknown* is the invalid line found in the configuration/batch file.

Appendix B

Error Messages

This appendix briefly describes the error messages associated with the programmers. It also gives reasons why the error occurred and suggestions on how to fix the error. The messages are arranged in alphabetic order.

B.1 Error Message Descriptions

The following messages are common to all programmers.

`Chip inserted incorrectly, or bad - Retry, Abort`

For the microcontroller programmer, this message refers to the 2732, 2764, 27128, and 27256 devices.

For the gang programmer, this message refers to the master EPROM device.

Re-insert the device or replace the device with a new one.

`Current limit exceeded - Retry, Abort`

To program, the device requires more current than can be delivered by the PDS base unit.

`invalid channel function`

This is a communication error caused by the firmware receiving an invalid software interrupt code.

Select the retry option. If the problem persists, the software and firmware could be incompatible. Use the latest release of firmware **and** software.

`invalid command - Retry, Abort`

The firmware does not recognize the command sent by the software. The usual cause is that the firmware and software are incompatible.

Use the latest release of firmware **and** software.

`invalid family code - Retry, Abort`

The family code defined in the device table is not supported by the programmer.

Use valid family codes as listed in the configuration parameter table in Appendix 3.

`invalid programming range - Retry, Abort`

The programming range is not valid for the device to be programmed. This is often caused when you try to program a TMS370 device at the register or peripheral file address locations. You cannot program to these locations.

Check whether the defined range overlaps the register or peripheral file locations. Also, make sure you have a valid address range for your device in the configuration parameter table in Appendix 3.

invalid Vcc chosen - Retry, Abort

The V_{CC} value you have chosen for your device is invalid.

Use a valid V_{CC} value—0, 5, or 6 volts.

invalid VPP chosen - Retry, Abort

The V_{PP} value you have chosen is invalid.

Use a valid V_{PP} value—0, 5, 12, 12.5, or 21 volts.

unable to communicate with TMS370 device - Retry, Abort

The programmer is unable to communicate with the TMS370 microcontroller. The microcontroller may have bent pins, may be inserted incorrectly, or may be inoperable. If you are using the gang programmer, a single bad microcontroller can prevent the programmer from communication with any of the devices.

Check each microcontroller for proper orientation or for bent pins.

unable to program after 25 attempts - Retry, Abort

The target EPROM location is bad.

Use a different location or replace the target device.

unable to read byte before timeout - Retry, Abort

The programmer is unable to communicate with the TMS370 microcontroller. The microcontroller may have bent pins, may be inserted incorrectly, or may be inoperable. If you are using the gang programmer, a single bad microcontroller can prevent the programmer from communication with any of the devices.

Check each microcontroller for proper orientation or for bent pins.

unable to write byte - Retry, Abort

The EPROM is not erased, and the programmer is unable to program a 1, because a 0 has already been burned into the same address.



These error messages are specific to the gang programmers.

checksum error in master device - Retry, Abort

The data in the master device is corrupt.

Replace the master EPROM.

illegal memory type detected in master - Retry, Abort

The master EPROM device has illegal configuration data.

Replace the master EPROM.

Invalid master configuration data

The configurable data of the master device is corrupt, or else the master device is blank.

Replace the master EPROM.

master device is not blank

The master device you are trying to program is not blank.

Replace the master device, or erase the existing master device before programming it.

unable to calculate checksum.

There is an error in calculating the checksum after the master header information was written.

This signifies either a communication error or that the master device is bad.

unable to write header information

A memory write error occurred when an attempt was made to write the configuration data to the first 256 bytes in the master EPROM device.

Replace the master EPROM device.

Appendix C

Configuration Parameters

Table C–1 describes the valid configuration parameters for the programmers discussed in this manual. Use of invalid parameters will result in programming errors.

Table C–1. Valid Configuration Parameters

Device Family	Device 1st Name	Start	Size	Type	V _{CC}	V _{PP}	Pdt	Ctrl Reg.	Family Code	Block Erase	Program Alg.
27128	TMS27C128	0000h	4000h	EPROM	6	12.5	01	00h	42h	No	0s only
27256	TMS27C256	0000h	8000h	EPROM	6	12.5	01	00h	43h	No	0s only
2732	TMS2732A	0000h	1000h	EPROM	5	21	10	00h	40h	No	0s only
2764	TMS2764	0000h	2000h	EPROM	6	21	01	00h	41h	No	0s only
2764	TMS27C64	0000h	2000h	EPROM	6	12.5	01	00h	41h	No	0s only
7742	TMS7742	F000h	1000h	EPROM	5	21	10	00h	20h	No	0s only
TMS370	16K_PE	4000h	4000h	EPROM	5	12.5	01	1Ch	11h	No	0s only
TMS370	256_DEE	1F00h	0100h	EEPROM	5	12	10	1Ah	10h	to 0s	1s only
TMS370	4K_PEE	7000h	1000h	EEPROM	5	12	10	1Ch	10h	to 0s	1s only
TMS370	512_DEE	1E00h	0200h	EEPROM	5	12	10	1Ah	10h	to 0s	1s only
TMS370	C010	1F00h	0100h	EEPROM	5	12	10	1Ah	10h	to 0s	1s only
TMS370	C050	1F00h	0100h	EEPROM	5	12	10	1Ah	10h	to 0s	1s only
TMS370	C052	1F00h	0100h	EEPROM	5	12	10	1Ah	10h	to 0s	1s only
TMS370	C056	1E00h	0200h	EEPROM	5	12	10	1Ah	10h	to 0s	1s only
TMS370	C250	1F00h	0100h	EEPROM	5	12	10	1Ah	10h	to 0s	1s only
TMS370	C256	1E00h	0200h	EEPROM	5	12	10	1Ah	10h	to 0s	1s only
TMS370	C756	1E00h	0200h	EEPROM	5	12	10	1Ah	10h	to 0s	1s only
		4000h	4000h	EPROM	5	12.5	01	1Ch	11h	No	0s only
TMS370	C810	1F00h	0100h	EEPROM	5	12	10	1Ah	10h	to 0s	1s only
		7000h	1000h	EEPROM	5	12	10	1Ch	10h	to 0s	1s only
TMS370	C850	1F00h	0100h	EEPROM	5	12	10	1Ah	10h	to 0s	1s only
		7000h	1000h	EEPROM	5	12	10	1Ch	10h	to 0s	1s only

Appendix D

Using Keystroke Capture Files

A **keystroke capture file** is a file in which the keystrokes you type are recorded to be replayed later. Keystroke capture files are useful in setting up the programmer to perform a commonly repeated program or to verify operation.

Two command line switches allow the recording and replaying of keystroke files, and a control character allows you to turn off recording of a keystroke file.

`/Cfilename.ext` records keystrokes into file *filename.ext*

`/Kfilename.ext` replays keystrokes from file *filename.ext*



  stops recording keystrokes

For example, assume you are programming a TMS370C756 to check your code. As you make changes to the code, you program another device. The steps required to select the device, fill the memory to FF's, and to load the file can all be recorded in a keystroke file so that you do not have to type them each time you program or verify the device.

In the following example, it is assumed that the program is contained in the file `a.out`, which is in the directory `DEMO` on the current drive. The device selected is `TMS370 16K_PE`, the seventh entry in the default device table. The keystroke file used is `example.key`.

To create a keystroke capture file, invoke the programmer with the `/C` option followed immediately by a filename (there are no spaces between the 'C' and the filename).

```
prgrm370 /cexample.key
```

Select the device type, fill the memory with FF's, and load the object file as normal. Before the actual program or verify step, stop the keystroke recording by pressing  . The following file, `example.key`, is created.

Example D-1. Keystroke File Example.key

```

C$DARW          choose device
$DARW          move cursor down to 370C756 device
$DARW
$DARW
$DARW
$DARW
$DARW
$F5            select this device
$ESC          go back to top menu
d$F3          go to display window, select address 4000h
4000h$CR
f4000h$CR      fill memory starting at address 4000h
4000h$CR      length of fill 4000h bytes
0ffh$CR       fill value 0FFh
1\demo\a.out$CR load object file 'demo\a.out'
$CR
$SRECORD      stop replaying keystroke file
    
```

To replay this keystroke file, invoke the programmer with a /k option followed immediately by the filename.

```
prgrm370 /kexample.key
```

From the code above, nonprintable characters are recorded as text names preceded with \$. Table D-1 lists the valid nonprintable characters.

Table D-1. Valid Nonprintable Characters

Text Name	Actual Keystroke
\$BS	back space
\$CR	return
\$DARW	down arrow
\$DEL	delete
\$DOL	\$
\$ESC	escape
\$F0	F10
\$F1	F1
\$F2	F2
\$F3	F3
\$F4	F4
\$F5	F5
\$F6	F6
\$F7	F7
\$F8	F8
\$F9	F9

Text Name	Actual Keystroke
\$INS	insert
\$LARW	left arrow arrow
\$RAWR	right arrow
\$SRECORD	stop record
\$SP	space
\$TAB	tab
\$UARW	up arrow

Index

A

- add device command, 2-9
- address range, PC memory, 3-5

B

- batch mode
 - command descriptions, A-3
 - executable*, A-3
 - nonexecutable*, A-4
 - description, A-2
 - status messages, A-5
- block erase, 2-8

C

- choose device command, 2-15
- command menus, proper usage, 2-2, 3-2
- commands
 - configuration window, 2-5
 - differences between microcontroller and gang, 3-7
 - display window, 3-6
- communication port, 2-7
- configuration parameters, valid values, C-1
- configuration parameters, 2-7
 - editing, 2-11
 - loading, 2-14
 - saving, 2-15
- configuration window
 - command line, 2-5
 - commands, 2-5
 - add device*, 2-9
 - choose device*, 2-15
 - display*, 2-16
 - edit*, 2-11
 - configuration parameters, 2-11

- device table, 2-12
- load*, 2-14
 - configuration parameters, 2-14
 - device table, 2-14
- quit*, 2-16
- save*, 2-15
 - configuration parameters, 2-15
 - device table, 2-15
- show ID (software revision information)*, 2-9
 - description, 2-5
 - device table, 2-6
 - program configuration area, 2-5
 - show ranges window, 2-7

D

- default values, configuration, 2-7
- device table
 - editing, 2-12
 - loading, 2-14
 - saving, 2-15
- device type, 2-7
- DIP orientation, 1-12
- DIP socket, 1-11
- display, disassembled, 3-6
- display command, 2-16
- display window
 - commands, 3-6
 - edit (PC memory)*, 3-26
 - fill (PC memory)*, 3-8
 - load (COFF file)*, 3-9
 - master*, 3-27
 - program, 3-27
 - upload, 3-27
 - move (PC memory)*, 3-12
 - output (COFF file)*, 3-10
 - program*, 3-13, 3-15
 - quit*, 3-28
 - show (text file)*, 3-17
 - commands, 3-17

upload, 3-27
memory, PC, 1-2
microcontroller programmer
 description, 1-2
 features, 1-2
 physical description, 1-3
move PC memory command, 3-12

O

output COFF file command, 3-10

P

parameters. *See* configuration parameters
PC connection, 1-9
PC memory address range, 3-5
PC memory display, 3-5
position-at-bottom-of-file command, 3-18
position-at-line-number command, 3-18
position-at-top-of-file command, 3-18
program device command, 3-13, 3-15
programming algorithms, 2-8
pulse duration, program, 2-7

Q

quit command, 2-16, 3-28

R

reverse assembled code display, 3-5
 commands, 3-7

S

save command, 2-15

show ID command, 2-9
show ranges window, 2-7
 parameter summary, 2-7
show text file command, 3-17
 commands, 3-17
 bottom of file (positioning), 3-18
 find (character strings), 3-18
 line (positioning), 3-18
 next (character strings), 3-18
 top of file (positioning), 3-18
socket, DIP, 1-11
sockets, IC, 1-11
software installation, 1-14
starting the programmer, 1-16
system command, 3-28

T

technical assistance, 1-1
TMS370 hotline, 1-1

U

upload device command, 3-19, 3-20

V

valid address ranges, editing, 2-12
verification file format, 3-14
verify device command, 3-22, 3-23

W

windows
 configuration, 2-5
 display, 3-5
 show ranges, 2-7

Index

Index-4

IMPORTANT NOTICE

Texas Instruments (TI) reserves the right to make changes to its products or to discontinue any semiconductor product or service without notice, and advises its customers to obtain the latest version of relevant information to verify, before placing orders, that the information being relied on is current.

TI warrants performance of its semiconductor products and related software to the specifications applicable at the time of sale in accordance with TI's standard warranty. Testing and other quality control techniques are utilized to the extent TI deems necessary to support this warranty. Specific testing of all parameters of each device is not necessarily performed, except those mandated by government requirements.

Certain applications using semiconductor products may involve potential risks of death, personal injury, or severe property or environmental damage ("Critical Applications").

TI SEMICONDUCTOR PRODUCTS ARE NOT DESIGNED, INTENDED, AUTHORIZED, OR WARRANTED TO BE SUITABLE FOR USE IN LIFE-SUPPORT APPLICATIONS, DEVICES OR SYSTEMS OR OTHER CRITICAL APPLICATIONS.

Inclusion of TI products in such applications is understood to be fully at the risk of the customer. Use of TI products in such applications requires the written approval of an appropriate TI officer. Questions concerning potential risk applications should be directed to TI through a local SC sales office.

In order to minimize risks associated with the customer's applications, adequate design and operating safeguards should be provided by the customer to minimize inherent or procedural hazards.

TI assumes no liability for applications assistance, customer product design, software performance, or infringement of patents or services described herein. Nor does TI warrant or represent that any license, either express or implied, is granted under any patent right, copyright, mask work right, or other intellectual property right of TI covering or relating to any combination, machine, or process in which such semiconductor products or services might be or are used.