

TMS320x2833x, 2823x Serial Peripheral Interface (SPI)

Reference Guide



Literature Number: SPRUEU3A
August 2008–Revised June 2009

Preface	7
1 Serial Peripheral Interface (SPI)	9
1.1 Enhanced SPI Module Overview	10
1.1.1 SPI Block Diagram	12
1.1.2 SPI Module Signal Summary	13
1.2 Overview of SPI Module Registers	13
1.3 SPI Operation	14
1.3.1 Introduction to Operation	14
1.3.2 SPI Module Slave and Master Operation Modes	15
1.4 SPI Interrupts	16
1.4.1 SPI Interrupt Control Bits	16
1.4.2 Data Format	17
1.4.3 Baud Rate and Clocking Schemes	18
1.4.4 Initialization Upon Reset	20
1.4.5 Data Transfer Example	20
1.5 SPI FIFO Description	21
1.5.1 SPI Interrupts	22
2 SPI Registers and Waveforms	25
2.1 SPI Control Registers	26
2.1.1 SPI Configuration Control Register (SPICCR)	26
2.1.2 SPI Operation Control Register (SPICTL)	27
2.1.3 SPI Status Register (SPIST)	28
2.1.4 SPI Baud Rate Register (SPIBRR)	29
2.1.5 SPI Emulation Buffer Register (SPIRXEMU)	29
2.1.6 SPI Serial Receive Buffer Register (SPIRXBUF)	30
2.1.7 SPI Serial Transmit Buffer Register (SPITXBUF)	30
2.1.8 SPI Serial Data Register (SPIDAT)	31
2.1.9 SPI FIFO Transmit, Receive, and Control Registers	32
2.1.10 SPI Priority Control Register (SPIPRI)	35
2.2 SPI Example Waveforms	35
A Revision History	39

List of Figures

1-1	SPI CPU Interface.....	10
1-2	Serial Peripheral Interface Module Block Diagram	12
1-3	SPI Master/Slave Connection	15
1-4	SPICLK Signal Options.....	19
1-5	SPI: SPICLK-CLKOUT Characteristic When (BRR + 1) is Odd, BRR > 3, and CLOCK POLARITY = 1.....	19
1-6	Five Bits per Character	21
1-7	SPI FIFO Interrupt Flags and Enable Logic Generation	22
2-1	SPI Configuration Control Register (SPICCR) — Address 7040h	26
2-2	SPI Operation Control Register (SPICL) — Address 7041h.....	27
2-3	SPI Status Register (SPIST) — Address 7042h	28
2-4	SPI Baud Rate Register (SPIBRR) — Address 7044h.....	29
2-5	SPI Emulation Buffer Register (SPIXEMU) — Address 7046h.....	30
2-6	SPI Serial Receive Buffer Register (SPIRXBUF) — Address 7047h.....	30
2-7	SPI Serial Transmit Buffer Register (SPITXBUF) — Address 7048h	31
2-8	SPI Serial Data Register (SPIDAT) — Address 7049h	31
2-9	SPI FIFO Transmit (SPIFFTX) Register – Address 704Ah	32
2-10	SPI FIFO Receive (SPIFFRX) Register – Address 704Bh	33
2-11	SPI FIFO Control (SPIFFCT) Register – Address 704Ch	34
2-12	CLOCK POLARITY = 0, CLOCK PHASE = 0 (All data transitions are during the rising edge, non-delayed clock. Inactive level is low.)	35
2-13	CLOCK POLARITY = 0, CLOCK PHASE = 1 (All data transitions are during the rising edge, but delayed by half clock cycle. Inactive level is low.)	36
2-14	CLOCK POLARITY = 1, CLOCK PHASE = 0 (All data transitions are during the falling edge. Inactive level is high.)	36
2-15	CLOCK POLARITY = 1, CLOCK PHASE = 1 (All data transitions are during the falling edge, but delayed by half clock cycle. Inactive level is high.)	37
2-16	$\overline{\text{SPISTE}}$ Behavior in Master Mode (Master lowers $\overline{\text{SPISTE}}$ during the entire 16 bits of transmission.)	37
2-17	$\overline{\text{SPISTE}}$ Behavior in Slave Mode (Slave's $\overline{\text{SPISTE}}$ is lowered during the entire 16 bits of transmission.)	38

List of Tables

1-1	SPI Module Signal Summary	13
1-2	SPI Registers	13
1-3	SPI Clocking Scheme Selection Guide.....	19
1-4	SPI Interrupt Flag Modes.....	22
2-1	SPI Configuration Control Register (SPICCR) Field Descriptions	26
2-2	Character Length Control Bit Values	27
2-3	SPI Operation Control Register (SPICTL) Field Descriptions	27
2-4	SPI Status Register (SPIST) Field Descriptions	28
2-5	Field Descriptions	29
2-6	SPI Emulation Buffer Register (SPIXEMU) Field Descriptions.....	30
2-7	SPI Serial Receive Buffer Register (SPIRXBUF) Field Descriptions	30
2-8	SPI Serial Transmit Buffer Register (SPITXBUF) Field Descriptions	31
2-9	SPI Serial Data Register (SPIDAT) Field Descriptions.....	31
2-10	SPI FIFO Transmit (SPIFFTX) Register Field Descriptions	32
2-11	SPI FIFO Receive (SPIFFRX) Register Field Descriptions.....	33
2-12	SPI FIFO Control (SPIFFCT) Register Field Descriptions	34
2-13	SPI Priority Control Register (SPIPRI) Field Descriptions	35
A-1	Changes in Revision A	39

This guide describes how the serial peripheral interface works.

About This Manual

The SPI module described in this reference guide is a Type 0 SPI. See the *TMS320x28xx, 28xxx DSP Peripheral Reference Guide* ([SPRU566](#)) for a list of all devices with an SPI module of the same type, to determine the differences between types, and for a list of device-specific differences within a type.

Related Documentation From Texas Instruments

The following books describe the TMS320x2833x, 2823x devices and related support tools that are available on the TI website.

Data Manual and Errata—

SPRS439— [TMS320F28335](#), [TMS320F28334](#), [TMS320F28332](#), [TMS320F28235](#), [TMS320F28234](#), [TMS320F28232 Digital Signal Controllers \(DSCs\) Data Manual](#) contains the pinout, signal descriptions, as well as electrical and timing specifications for the F2833x/2823x devices.

SPRZ272— [TMS320F28335](#), [F28334](#), [F28332](#), [TMS320F28235](#), [F28234](#), [F28232 Digital Signal Controllers \(DSCs\) Silicon Errata](#) describes the advisories and usage notes for different versions of silicon.

CPU User's Guides—

SPRU430— **TMS320C28x CPU and Instruction Set Reference Guide** describes the central processing unit (CPU) and the assembly language instructions of the TMS320C28x fixed-point digital signal processors (DSPs). It also describes emulation features available on these DSPs.

SPRUE02— **TMS320C28x Floating Point Unit and Instruction Set Reference Guide** describes the floating-point unit and includes the instructions for the FPU.

Peripheral Guides—

SPRU566— **TMS320x28xx, 28xxx DSP Peripheral Reference Guide** describes the peripheral reference guides of the 28x digital signal processors (DSPs).

SPRUFB0— **TMS320x2833x, 2823x System Control and Interrupts Reference Guide** describes the various interrupts and system control features of the 2833x and 2823x digital signal controllers (DSCs).

SPRU812— **TMS320x2833x, 2823x Analog-to-Digital Converter (ADC) Reference Guide** describes how to configure and use the on-chip ADC module, which is a 12-bit pipelined ADC.

SPRU949— **TMS320x2833x, 2823x DSC External Interface (XINTF) Reference Guide** describes the XINTF, which is a nonmultiplexed asynchronous bus, as it is used on the 2833x and 2823x devices.

SPRU963— **TMS320x2833x, 2823x Boot ROM Reference Guide** describes the purpose and features of the bootloader (factory-programmed boot-loading software) and provides examples of code. It also describes other contents of the device on-chip boot ROM and identifies where all of the information is located within that memory.

SPRUFB7— **TMS320x2833x, 2823x Multichannel Buffered Serial Port (McBSP) Reference Guide** describes the McBSP available on the 2833x and 2823x devices. The McBSPs allow direct interface between a DSP and other devices in a system.

- [SPRUFB8](#)**— **TMS320x2833x, 2823x Direct Memory Access (DMA) Module Reference Guide** describes the DMA on the 2833x and 2823x devices.
- [SPRUG04](#)**— **TMS320x2833x, 2823x Enhanced Pulse Width Modulator (ePWM) Module Reference Guide** describes the main areas of the enhanced pulse width modulator that include digital motor control, switch mode power supply control, UPS (uninterruptible power supplies), and other forms of power conversion.
- [SPRUG02](#)**— **TMS320x2833x, 2823x High-Resolution Pulse Width Modulator (HRPWM) Reference Guide** describes the operation of the high-resolution extension to the pulse width modulator (HRPWM).
- [SPRUG4](#)**— **TMS320x2833x, 2823x Enhanced Capture (eCAP) Module Reference Guide** describes the enhanced capture module. It includes the module description and registers.
- [SPRUG05](#)**— **TMS320x2833x, 2823x Enhanced Quadrature Encoder Pulse (eQEP) Module Reference Guide** describes the eQEP module, which is used for interfacing with a linear or rotary incremental encoder to get position, direction, and speed information from a rotating machine in high-performance motion and position control systems. It includes the module description and registers.
- [SPRUEU1](#)**— **TMS320x2833x, 2823x Enhanced Controller Area Network (eCAN) Reference Guide** describes the eCAN that uses established protocol to communicate serially with other controllers in electrically noisy environments.
- [SPRUFZ5](#)**— **TMS320x2833x, 2823x Serial Communications Interface (SCI) Reference Guide** describes the SCI, which is a two-wire asynchronous serial port, commonly known as a UART. The SCI modules support digital communications between the CPU and other asynchronous peripherals that use the standard non-return-to-zero (NRZ) format.
- [SPRUEU3](#)**— **TMS320x2833x, 2823x DSC Serial Peripheral Interface (SPI) Reference Guide** describes the SPI - a high-speed synchronous serial input/output (I/O) port - that allows a serial bit stream of programmed length (one to sixteen bits) to be shifted into and out of the device at a programmed bit-transfer rate.
- [SPRUG03](#)**— **TMS320x2833x, 2823x Inter-Integrated Circuit (I2C) Module Reference Guide** describes the features and operation of the inter-integrated circuit (I2C) module.
- Tools Guides—**
- [SPRU513](#)**— **TMS320C28x Assembly Language Tools v5.0.0 User's Guide** describes the assembly language tools (assembler and other tools used to develop assembly language code), assembler directives, macros, common object file format, and symbolic debugging directives for the TMS320C28x device.
- [SPRU514](#)**— **TMS320C28x Optimizing C/C++ Compiler v5.0.0 User's Guide** describes the TMS320C28x™ C/C++ compiler. This compiler accepts ANSI standard C/C++ source code and produces TMS320 DSP assembly language source code for the TMS320C28x device.
- [SPRU608](#)**— **TMS320C28x Instruction Set Simulator Technical Overview** describes the simulator, available within the Code Composer Studio for TMS320C2000 IDE, that simulates the instruction set of the C28x™ core.
- [SPRU625](#)**— **TMS320C28x DSP/BIOS 5.32 Application Programming Interface (API) Reference Guide** describes development using DSP/BIOS.

Trademarks

Code Composer Studio and C28x are trademarks of Texas Instruments.

Serial Peripheral Interface (SPI)

The serial peripheral interface (SPI) is a high-speed synchronous serial input/ output (I/O) port that allows a serial bit stream of programmed length (one to sixteen bits) to be shifted into and out of the device at a programmed bit-transfer rate. The SPI is normally used for communications between the DSP controller and external peripherals or another controller. Typical applications include external I/O or peripheral expansion via devices such as shift registers, display drivers, and analog-to-digital converters (ADCs). Multidevice communications are supported by the master/slave operation of the SPI. On the C28x™, the port supports a 16-level, receive and transmit FIFO for reducing CPU servicing overhead.

This reference guide is applicable for the SPI found on the TMS320x2833x and 2823x families of digital signal controllers (DSCs). This includes all Flash-based, ROM-based and RAM-based devices within these families.

Note: The 28x SPI features several enhancements compared to the 240xA SPI. See section 1.5 for a description of these features.

Topic	Page
1.1 Enhanced SPI Module Overview	10
1.2 Overview of SPI Module Registers	13
1.3 SPI Operation	14
1.4 SPI Interrupts	16
1.5 SPI FIFO Description	21

1.1 Enhanced SPI Module Overview

Figure 1-1 shows the SPI CPU interfaces.

Figure 1-1. SPI CPU Interface

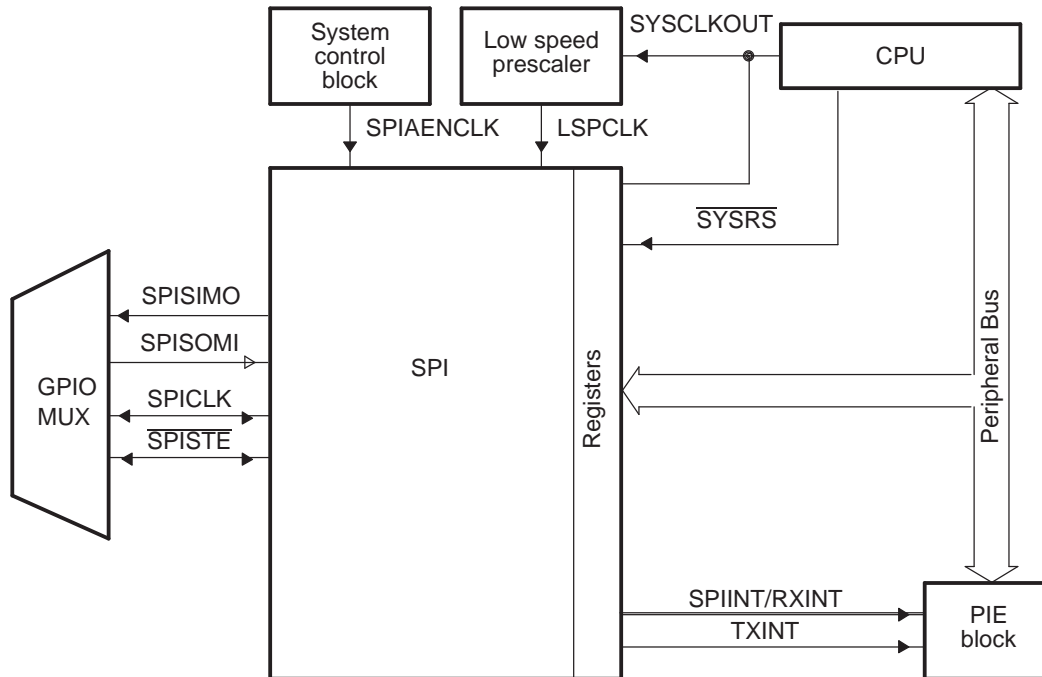

The SPI module features include:

- SPISOMI: SPI slave-output/master-input pin
- SPISIMO: SPI slave-input/master-output pin
- $\overline{\text{SPISTE}}$: SPI slave transmit-enable pin
- SPICLK: SPI serial-clock pin

Note: All four pins can be used as GPIO, if the SPI module is not used.

- Two operational modes: master and slave
- Baud rate: 125 different programmable rates. The maximum baud rate that can be employed is limited by the maximum speed of the I/O buffers used on the SPI pins. See the device-specific data sheet for more details.
- Data word length: one to sixteen data bits
- Four clocking schemes (controlled by clock polarity and clock phase bits) include:
 - Falling edge without phase delay: SPICLK active-high. SPI transmits data on the falling edge of the SPICLK signal and receives data on the rising edge of the SPICLK signal.
 - Falling edge with phase delay: SPICLK active-high. SPI transmits data one half-cycle ahead of the falling edge of the SPICLK signal and receives data on the falling edge of the SPICLK signal.
 - Rising edge without phase delay: SPICLK inactive-low. SPI transmits data on the rising edge of the SPICLK signal and receives data on the falling edge of the SPICLK signal.
 - Rising edge with phase delay: SPICLK inactive-low. SPI transmits data one half-cycle ahead of the falling edge of the SPICLK signal and receives data on the rising edge of the SPICLK signal.
- Simultaneous receive and transmit operation (transmit function can be disabled in software)
- Transmitter and receiver operations are accomplished through either interrupt-driven or polled algorithms.

- 12 SPI module control registers: Located in control register frame beginning at address 7040h.

Note: All registers in this module are 16-bit registers that are connected to Peripheral Frame 2. When a register is accessed, the register data is in the lower byte (7–0), and the upper byte (15–8) is read as zeros. Writing to the upper byte has no effect.

Enhanced Features:

- 16-level transmit/receive FIFO
- Delayed transmit control

1.1.1 SPI Block Diagram

Figure 1-2 is a block diagram of the SPI in slave mode, showing the basic control blocks available on the SPI module.

Figure 1-2. Serial Peripheral Interface Module Block Diagram

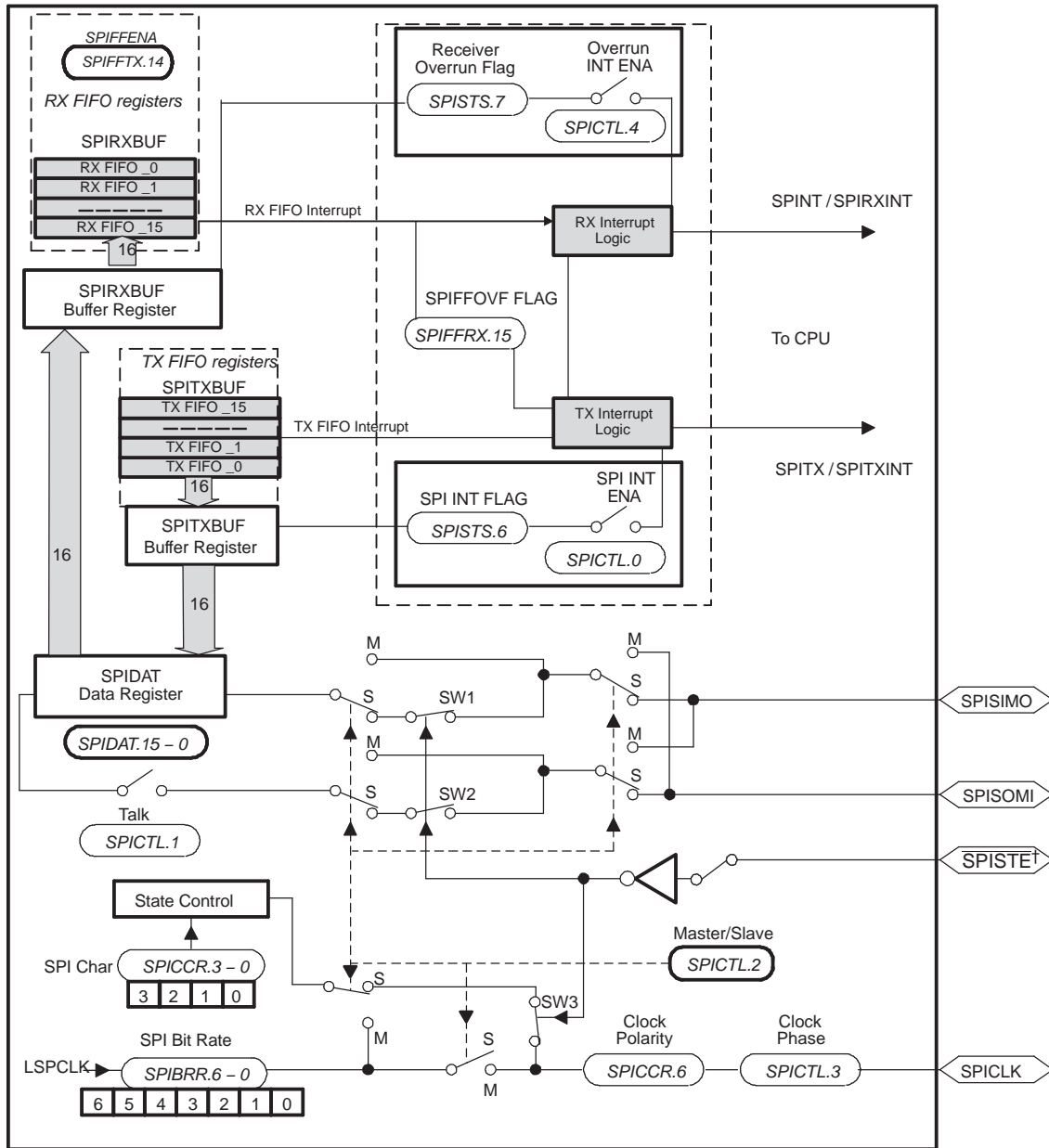

A $\overline{\text{SPISTE}}$ of a slave device is driven low by the master.

1.1.2 SPI Module Signal Summary

Table 1-1. SPI Module Signal Summary

Signal Name	Description
External Signals	
SPICLK	SPI clock
SPISIMO?	SPI slave in, master out
SPISOMI	SPI slave out, master in
$\overline{\text{SPISTE}}$	SPI slave transmit enable
Control	
SPI Clock Rate	LSPCLK
Interrupt signals	
SPIRXINT	Transmit interrupt/ Receive Interrupt in non FIFO mode (referred to as SPI INT)
	Receive in interrupt in FIFO mode
SPITXINT	Transmit interrupt – FIFO

1.2 Overview of SPI Module Registers

The SPI port operation is configured and controlled by the registers listed in [Table 1-2](#).

Table 1-2. SPI Registers

Name	Address Range	Size (x16)	Description
SPICCR	0x0000-7040	1	SPI Configuration Control Register
SPICTL	0x0000-7041	1	SPI Operation Control Register
SPIST	0x0000-7042	1	SPI Status Register
SPIBRR	0x0000-7044	1	SPI Baud Rate Register
SPIEMU	0x0000-7046	1	SPI Emulation Buffer Register
SPIRXBUF	0x0000-7047	1	SPI Serial Input Buffer Register
SPITXBUF	0x0000-7048	1	SPI Serial Output Buffer Register
SPIDAT	0x0000-7049	1	SPI Serial Data Register
SPIFFTX	0x0000-704A	1	SPI FIFO Transmit Register
SPIFFRX	0x0000-704B	1	SPI FIFO Receive Register
SPIFFCT	0x0000-704C	1	SPI FIFO Control Register
SPIPRI	0x0000-704F	1	SPI Priority Control Register

This SPI has 16-bit transmit and receive capability, with double-buffered transmit and double-buffered receive. All data registers are 16-bits wide.

The SPI is no longer limited to a maximum transmission rate of LSPCLK/8 in slave mode. The maximum transmission rate in both slave mode and master mode is now LSPCLK/4.

Writes of transmit data to the serial data register, SPIDAT (and the new transmit buffer, SPITXBUF), must be left-justified within a 16-bit register.

The control and data bits for general-purpose bit I/O multiplexing have been removed from this peripheral, along with the associated registers, SPIPC1 (704Dh) and SPIPC2 (704Eh). These bits are now in the General-Purpose I/O registers.

Twelve registers inside the SPI module control the SPI operations:

- SPICCR (SPI configuration control register). Contains control bits used for SPI configuration
 - SPI module software reset
 - SPICLK polarity selection
 - Four SPI character-length control bits

- SPICTL (SPI operation control register). Contains control bits for data transmission
 - Two SPI interrupt enable bits
 - SPICLK phase selection
 - Operational mode (master/slave)
 - Data transmission enable
- SPISTS (SPI status register). Contains two receive buffer status bits and one transmit buffer status bit
 - RECEIVER OVERRUN
 - SPI INT FLAG
 - TX BUF FULL FLAG
- SPIBRR (SPI baud rate register). Contains seven bits that determine the bit transfer rate
- SPIRXEMU (SPI receive emulation buffer register). Contains the received data. This register is used for emulation purposes only. The SPIRXBUF should be used for normal operation
- SPIRXBUF (SPI receive buffer — the serial receive buffer register). Contains the received data
- SPITXBUF (SPI transmit buffer — the serial transmit buffer register). Contains the next character to be transmitted
- SPIDAT (SPI data register). Contains data to be transmitted by the SPI, acting as the transmit/receive shift register. Data written to SPIDAT is shifted out on subsequent SPICLK cycles. For every bit shifted out of the SPI, a bit from the receive bit stream is shifted into the other end of the shift register
- SPIPRI (SPI priority register). Contains bits that specify interrupt priority and determine SPI operation on the XDS™ emulator during program suspensions.

1.3 SPI Operation

This section describes the operation of the SPI. Included are explanations of the operation modes, interrupts, data format, clock sources, and initialization. Typical timing diagrams for data transfers are given.

1.3.1 Introduction to Operation

[Figure 1-3](#) shows typical connections of the SPI for communications between two controllers: a master and a slave.

The master initiates data transfer by sending the SPICLK signal. For both the slave and the master, data is shifted out of the shift registers on one edge of the SPICLK and latched into the shift register on the opposite SPICLK clock edge. If the CLOCK PHASE bit (SPICTL.3) is high, data is transmitted and received a half-cycle before the SPICLK transition (see [Section 1.3.2](#)). As a result, both controllers send and receive data simultaneously. The application software determines whether the data is meaningful or dummy data. There are three possible methods for data transmission:

- Master sends data; slave sends dummy data.
- Master sends data; slave sends data.
- Master sends dummy data; slave sends data.

The master can initiate data transfer at any time because it controls the SPICLK signal. The software, however, determines how the master detects when the slave is ready to broadcast data.

Figure 1-3. SPI Master/Slave Connection

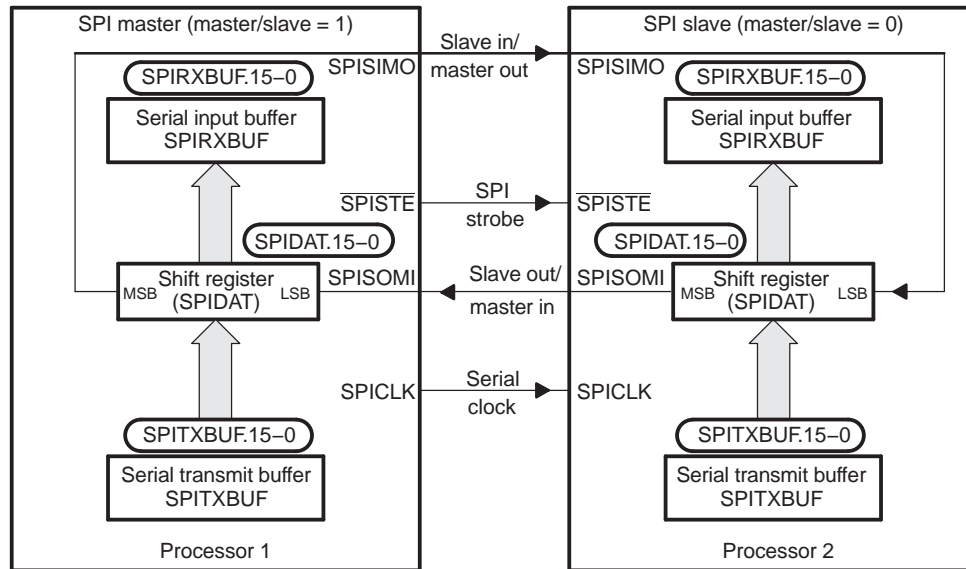

1.3.2 SPI Module Slave and Master Operation Modes

The SPI can operate in master or slave mode. The MASTER/SLAVE bit (SPICTL.2) selects the operating mode and the source of the SPICLK signal.

1.3.2.1 Master Mode

In the master mode (MASTER/SLAVE = 1), the SPI provides the serial clock on the SPICLK pin for the entire serial communications network. Data is output on the SPISIMO pin and latched from the SPISOMI pin.

The SPIBRR register determines both the transmit and receive bit transfer rate for the network. SPIBRR can select 126 different data transfer rates.

Data written to SPIDAT or SPITXBUF initiates data transmission on the SPISIMO pin, MSB (most significant bit) first. Simultaneously, received data is shifted through the SPISOMI pin into the LSB (least significant bit) of SPIDAT. When the selected number of bits has been transmitted, the received data is transferred to the SPIRXBUF (buffered receiver) for the CPU to read. Data is stored right-justified in SPIRXBUF.

When the specified number of data bits has been shifted through SPIDAT, the following events occur:

- SPIDAT contents are transferred to SPIRXBUF.
- SPI INT FLAG bit (SPISTS.6) is set to 1.
- If there is valid data in the transmit buffer SPITXBUF, as indicated by the TXBUF FULL bit in SPISTS, this data is transferred to SPIDAT and is transmitted; otherwise, SPICLK stops after all bits have been shifted out of SPIDAT.
- If the SPI INT ENA bit (SPICTL.0) is set to 1, an interrupt is asserted.

In a typical application, the $\overline{\text{SPISTE}}$ pin serves as a chip-enable pin for a slave SPI device. This pin is driven low by the master before transmitting data to the slave and is taken high after the transmission is complete.

1.3.2.2 Slave Mode

In the slave mode (MASTER/SLAVE = 0), data shifts out on the SPISOMI pin and in on the SPISIMO pin. The SPICLK pin is used as the input for the serial shift clock, which is supplied from the external network master. The transfer rate is defined by this clock. The SPICLK input frequency should be no greater than the LSPCLK frequency divided by 4.

Data written to SPIDAT or SPITXBUF is transmitted to the network when appropriate edges of the SPICLK signal are received from the network master. Data written to the SPITXBUF register will be transferred to the SPIDAT register when all bits of the character to be transmitted have been shifted out of SPIDAT. If no character is currently being transmitted when SPITXBUF is written to, the data will be transferred immediately to SPIDAT. To receive data, the SPI waits for the network master to send the SPICLK signal and then shifts the data on the SPISIMO pin into SPIDAT. If data is to be transmitted by the slave simultaneously, and SPITXBUF has not been previously loaded, the data must be written to SPITXBUF or SPIDAT before the beginning of the SPICLK signal.

When the TALK bit (SPICTL.1) is cleared, data transmission is disabled, and the output line (SPISOMI) is put into the high-impedance state. If this occurs while a transmission is active, the current character is completely transmitted even though SPISOMI is forced into the high-impedance state. This ensures that the SPI is still able to receive incoming data correctly. This TALK bit allows many slave devices to be tied together on the network, but only one slave at a time is allowed to drive the SPISOMI line.

The $\overline{\text{SPISTE}}$ pin operates as the slave-select pin. An active-low signal on the $\overline{\text{SPISTE}}$ pin allows the slave SPI to transfer data to the serial data line; an inactive-high signal causes the slave SPI serial shift register to stop and its serial output pin to be put into the high-impedance state. This allows many slave devices to be tied together on the network, although only one slave device is selected at a time.

1.4 SPI Interrupts

This section includes information on the control bits that initialize interrupts, data format, clocking, initialization, and data transfer.

1.4.1 SPI Interrupt Control Bits

Five control bits are used to initialize the SPI interrupts:

- SPI INT ENA bit (SPICTL.0)
- SPI INT FLAG bit (SPISTS.6)
- OVERRUN INT ENA bit (SPICTL.4)
- RECEIVER OVERRUN FLAG bit (SPISTS.7)

1.4.1.1 SPI INT ENA Bit (SPICTL.0)

When the SPI interrupt-enable bit is set and an interrupt condition occurs, the corresponding interrupt is asserted.

- | | |
|---|------------------------|
| 0 | Disable SPI interrupts |
| 1 | Enable SPI interrupts |

1.4.1.2 SPI INT FLAG Bit (SPISTS.6)

This status flag indicates that a character has been placed in the SPI receiver buffer and is ready to be read.

When a complete character has been shifted into or out of SPIDAT, the SPI INT FLAG bit (SPISTS.6) is set, and an interrupt is generated if enabled by the SPI INT ENA bit (SPICTL.0). The interrupt flag remains set until it is cleared by one of the following events:

- The interrupt is acknowledged (this is different from the C240).
- The CPU reads the SPIRXBUF (reading the SPIRXEMU does not clear the SPI INT FLAG bit).
- The device enters IDLE2 or HALT mode with an IDLE instruction.
- Software clears the SPI SW RESET bit (SPICCR.7).
- A system reset occurs.

When the SPI INT FLAG bit is set, a character has been placed into the SPIRXBUF and is ready to be read. If the CPU does not read the character by the time the next complete character has been received, the new character is written into SPIRXBUF, and the RECEIVER OVERRUN Flag bit (SPISTS.7) is set.

1.4.1.3 OVERRUN INT ENA Bit (SPICTL.4)

Setting the overrun interrupt enable bit allows the assertion of an interrupt whenever the RECEIVER OVERRUN Flag bit (SPISTS.7) is set by hardware. Interrupts generated by SPISTS.7 and by the SPI INT FLAG bit (SPISTS.6) share the same interrupt vector.

- 0 Disable RECEIVER OVERRUN Flag bit interrupts
- 1 Enable RECEIVER OVERRUN Flag bit interrupts

1.4.1.4 RECEIVER OVERRUN FLAG Bit (SPISTS.7)

The RECEIVER OVERRUN Flag bit is set whenever a new character is received and loaded into the SPIRXBUF before the previously received character has been read from the SPIRXBUF. The RECEIVER OVERRUN Flag bit must be cleared by software.

1.4.2 Data Format

Four bits (SPICCR.3–0) specify the number of bits (1 to 16) in the data character. This information directs the state control logic to count the number of bits received or transmitted to determine when a complete character has been processed. The following statements apply to characters with fewer than 16 bits:

- Data must be left-justified when written to SPIDAT and SPITXBUF.
- Data read back from SPIRXBUF is right-justified.
- SPIRXBUF contains the most recently received character, right-justified, plus any bits that remain from previous transmission(s) that have been shifted to the left (shown in [Example 1-1](#)).

Example 1-1. Transmission of Bit From SPIRXBUF

Conditions:

1. Transmission character length = 1 bit (specified in bits SPICCR.3–0)
2. The current value of SPIDAT = 737Bh

SPIDAT (before transmission)																	
	0	1	1	1	0	0	1	1	0	1	1	1	1	0	1	1	
SPIDAT (after transmission)																	
(TXed) 0 ←	1	1	1	0	0	1	1	0	1	1	1	1	0	1	1	x ⁽¹⁾	← (RXed)
SPIRXBUF (after transmission)																	
	1	1	1	0	0	1	1	0	1	1	1	1	0	1	1	x ⁽¹⁾	

⁽¹⁾ x = 1 if SPISOMI data is high; x = 0 if SPISOMI data is low; master mode is assumed.

1.4.3 Baud Rate and Clocking Schemes

The SPI module supports 125 different baud rates and four different clock schemes. Depending on whether the SPI clock is in slave or master mode, the SPICLK pin can receive an external SPI clock signal or provide the SPI clock signal, respectively.

- In the slave mode, the SPI clock is received on the SPICLK pin from the external source, and can be no greater than the LSPCLK frequency divided by 4.
- In the master mode, the SPI clock is generated by the SPI and is output on the SPICLK pin, and can be no greater than the LSPCLK frequency divided by 4.

Example 1-2 shows how to determine the SPI baud rates.

Example 1-2. Baud Rate Determination

For SPIBRR = 3 to 127:

$$\text{SPI Baud Rate} = \frac{\text{LSPCLK}}{(\text{SPIBRR} + 1)} \quad (1-1)$$

For SPIBRR = 0, 1, or 2:

$$\text{SPI Baud Rate} = \frac{\text{LSPCLK}}{4} \quad (1-2)$$

where:

LSPCLK = Low-speed peripheral clock frequency of the device

SPIBRR = Contents of the SPIBRR in the master SPI device

To determine what value to load into SPIBRR, you must know the device system clock (LSPCLK) frequency (which is device-specific) and the baud rate at which you will be operating.

Example 1–2 shows how to determine the maximum baud rate at which a 240xA can communicate. Assume that LSPCLK = 40 MHz.

Example 1-3. Maximum Baud-Rate Calculation

$$\begin{aligned} \text{Maximum SPI Baud Rate} &= \frac{\text{LSPCLK}}{4} \\ &= \frac{40 \times 10^6}{4} \\ &= 10 \times 10^6 \text{ bps} \end{aligned} \quad (1-3)$$

1.4.3.1 SPI Clocking Schemes

The CLOCK POLARITY bit (SPICCR.6) and the CLOCK PHASE bit (SPICTL.3) control four different clocking schemes on the SPICLK pin. The CLOCK POLARITY bit selects the active edge, either rising or falling, of the clock. The CLOCK PHASE bit selects a half-cycle delay of the clock. The four different clocking schemes are as follows:

- **Falling Edge Without Delay.** The SPI transmits data on the falling edge of the SPICLK and receives data on the rising edge of the SPICLK.
- **Falling Edge With Delay.** The SPI transmits data one half-cycle ahead of the falling edge of the SPICLK signal and receives data on the falling edge of the SPICLK signal.
- **Rising Edge Without Delay.** The SPI transmits data on the rising edge of the SPICLK signal and receives data on the falling edge of the SPICLK signal.
- **Rising Edge With Delay.** The SPI transmits data one half-cycle ahead of the rising edge of the SPICLK signal and receives data on the rising edge of the SPICLK signal.

The selection procedure for the SPI clocking scheme is shown in Table 1-3. Examples of these four clocking schemes relative to transmitted and received data are shown in Figure 1-4.

Table 1-3. SPI Clocking Scheme Selection Guide

SPICLK Scheme	CLOCK POLARITY (SPICCR.6)	CLOCK PHASE (SPICTL.3)
Rising edge without delay	0	0
Rising edge with delay	0	1
Falling edge without delay	1	0
Falling edge with delay	1	1

Figure 1-4. SPICLK Signal Options

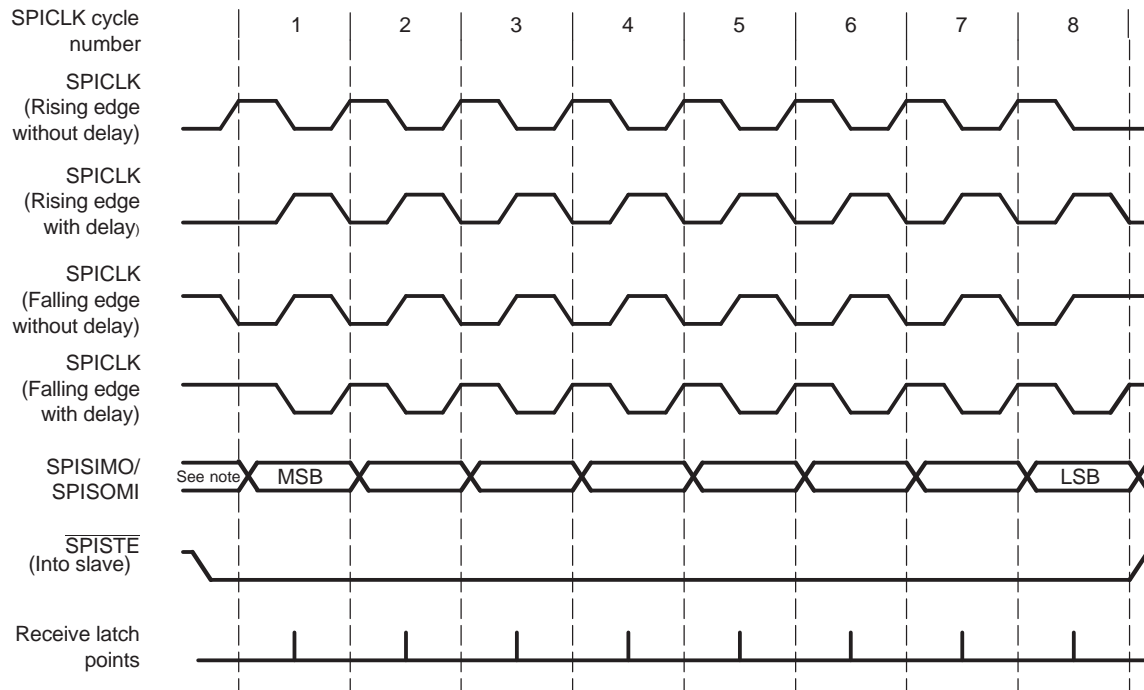

Note: Previous data bit

For the SPI, SPICLK symmetry is retained only when the result of (SPIBRR+1) is an even value. When (SPIBRR + 1) is an odd value and SPIBRR is greater than 3, SPICLK becomes asymmetrical. The low pulse of SPICLK is one CLKOUT longer than the high pulse when the CLOCK POLARITY bit is clear (0). When the CLOCK POLARITY bit is set to 1, the high pulse of the SPICLK is one CLKOUT longer than the low pulse, as shown in Figure 1-5.

Figure 1-5. SPI: SPICLK-CLKOUT Characteristic When (BRR + 1) is Odd, BRR > 3, and CLOCK POLARITY = 1

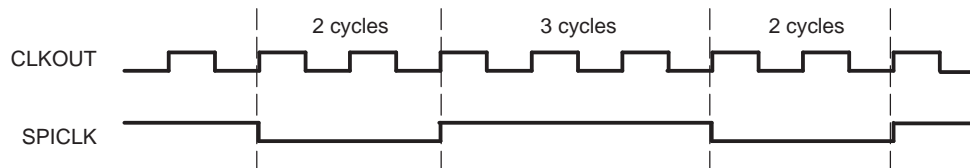

1.4.4 Initialization Upon Reset

A system reset forces the SPI peripheral module into the following default configuration:

- Unit is configured as a slave module (MASTER/SLAVE = 0)
- Transmit capability is disabled (TALK = 0)
- Data is latched at the input on the falling edge of the SPICLK signal
- Character length is assumed to be one bit
- SPI interrupts are disabled
- Data in SPIDAT is reset to 0000h
- SPI module pin functions are selected as general-purpose inputs (this is done in I/O MUX control register B [MCRB])

To change this SPI configuration:

- Step 1. Clear the SPI SW RESET bit (SPICCR.7) to 0 to force the SPI to the reset state.
- Step 2. Initialize the SPI configuration, format, baud rate, and pin functions as desired.
- Step 3. Set the SPI SW RESET bit to 1 to release the SPI from the reset state.
- Step 4. Write to SPIDAT or SPITXBUF (this initiates the communication process in the master).
- Step 5. Read SPIRXBUF after the data transmission has completed (SPISTS.6 = 1) to determine what data was received.

To prevent unwanted and unforeseen events from occurring during or as a result of initialization changes, clear the SPI SW RESET bit (SPICCR.7) before making initialization changes, and then set this bit after initialization is complete.

Note: Do not change SPI configuration when communication is in progress.

1.4.5 Data Transfer Example

The timing diagram shown in [Figure 1-6](#) illustrates an SPI data transfer between two devices using a character length of five bits with the SPICLK being symmetrical.

The timing diagram with SPICLK unsymmetrical ([Figure 1-5](#)) shares similar characterizations with [Figure 1-6](#) except that the data transfer is one CLKOUT cycle longer per bit during the low pulse (CLOCK POLARITY = 0) or during the high pulse (CLOCK POLARITY = 1) of the SPICLK.

[Figure 1-6](#) is applicable for 8-bit SPI only and is not for 24x devices that are capable of working with 16-bit data. The figure is shown for illustrative purposes only.

Figure 1-6. Five Bits per Character

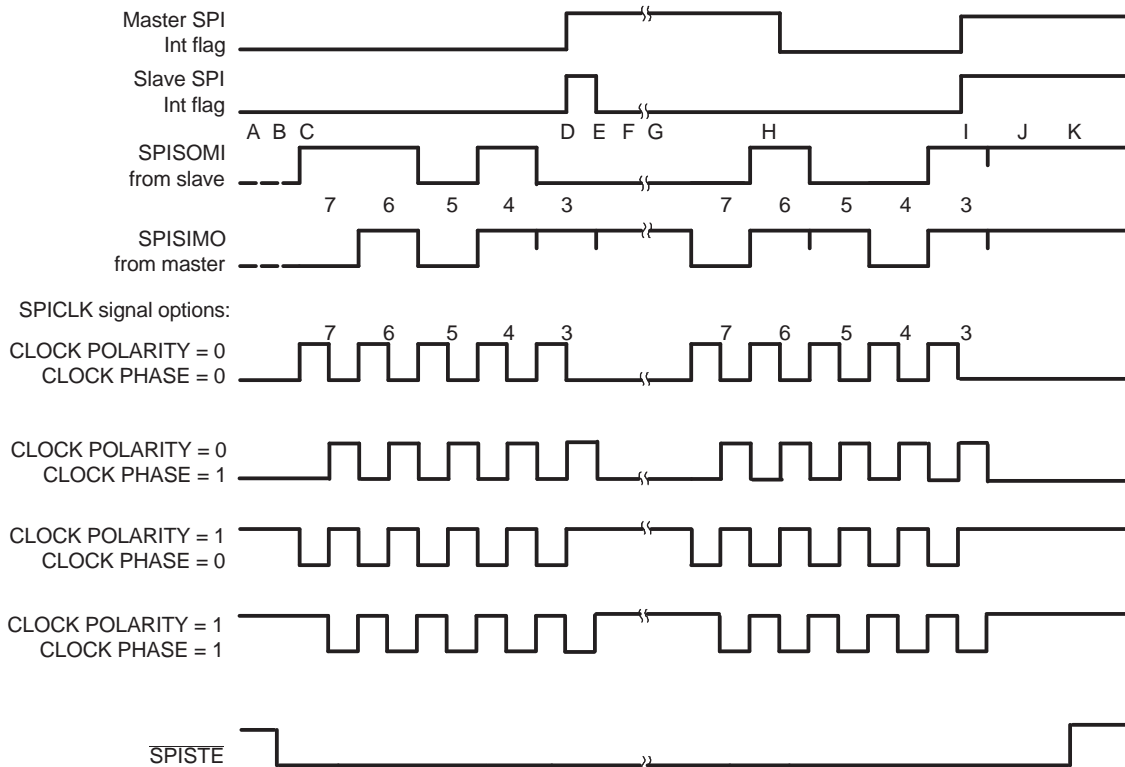

- A Slave writes 0D0h to SPIDAT and waits for the master to shift out the data.
- B Master sets the slave $\overline{\text{SPISTE}}$ signal low (active).
- C Master writes 058h to SPIDAT, which starts the transmission procedure.
- D First byte is finished and sets the interrupt flags.
- E Slave reads 0Bh from its SPIRXBUF (right-justified).
- F Slave writes 04Ch to SPIDAT and waits for the master to shift out the data.
- G Master writes 06Ch to SPIDAT, which starts the transmission procedure.
- H Master reads 01Ah from the SPIRXBUF (right-justified).
- I Second byte is finished and sets the interrupt flags.
- J Master reads 89h and the slave reads 8Dh from their respective SPIRXBUF. After the user's software masks off the unused bits, the master receives 09h and the slave receives 0Dh.
- K Master clears the slave $\overline{\text{SPISTE}}$ signal high (inactive).

1.5 SPI FIFO Description

The following steps explain the FIFO features and help with programming the SPI FIFOs:

1. Reset. At reset the SPI powers up in standard SPI mode, the FIFO function is disabled. The FIFO registers SPIFFTX, SPIFFRX and SPIFFCT remain inactive.
2. Standard SPI. The standard 240x SPI mode will work with SPIINT/SPIRXINT as the interrupt source.
3. Mode change. FIFO mode is enabled by setting the SPIFFEN bit to 1 in the SPIFFTX register. SPIRST can reset the FIFO mode at any stage of its operation.
4. Active registers. All the SPI registers and SPI FIFO registers SPIFFTX, SPIFFRX, and SPIFFCT will be active.
5. Interrupts. FIFO mode has two interrupts one for transmit FIFO, SPITXINT and one for receive FIFO, SPIINT/SPIRXINT. SPIINT/SPIRXINT is the common interrupt for SPI FIFO receive, receive error and receive FIFO overflow conditions. The single SPIINT for both transmit and receive sections of the standard SPI will be disabled and this interrupt will service as SPI receive FIFO interrupt.

6. Buffers. Transmit and receive buffers are supplemented with two 16x16 FIFOs. The one-word transmit buffer (TXBUF) of the standard SPI functions as a transition buffer between the transmit FIFO and shift register. The one-word transmit buffer will be loaded from transmit FIFO only after the last bit of the shift register is shifted out.
7. Delayed transfer. The rate at which transmit words in the FIFO are transferred to transmit shift register is programmable. The SPIFFCT register bits (7–0) FFTXDLY7–FFTXDLY0 define the delay between the word transfer. The delay is defined in number SPI serial clock cycles. The 8-bit register could define a minimum delay of 0 serial clock cycles and a maximum of 255 serial clock cycles. With zero delay, the SPI module can transmit data in continuous mode with the FIFO words shifting out back to back. With the 255 clock delay, the SPI module can transmit data in a maximum delayed mode with the FIFO words shifting out with a delay of 255 SPI clocks between each words. The programmable delay facilitates glueless interface to various slow SPI peripherals, such as EEPROMs, ADC, DAC etc.
8. FIFO status bits. Both transmit and receive FIFOs have status bits TXFFST or RXFFST (bits 12– 0) that define the number of words available in the FIFOs at any time. The transmit FIFO reset bit TXFIFO and receive reset bit RXFIFO will reset the FIFO pointers to zero when these bits are set to 1. The FIFOs will resume operation from start once these bits are cleared to zero.
9. Programmable interrupt levels. Both transmit and receive FIFO can generate CPU interrupts. The interrupt trigger is generated whenever the transmit FIFO status bits TXFFST (bits 12–8) match (less than or equal to) the interrupt trigger level bits TXFFIL (bits 4–0). This provides a programmable interrupt trigger for transmit and receive sections of the SPI. The default value for these trigger level bits will be 0x11111 for receive FIFO and 0x00000 for transmit FIFO respectively.

1.5.1 SPI Interrupts

Figure 1-7. SPI FIFO Interrupt Flags and Enable Logic Generation

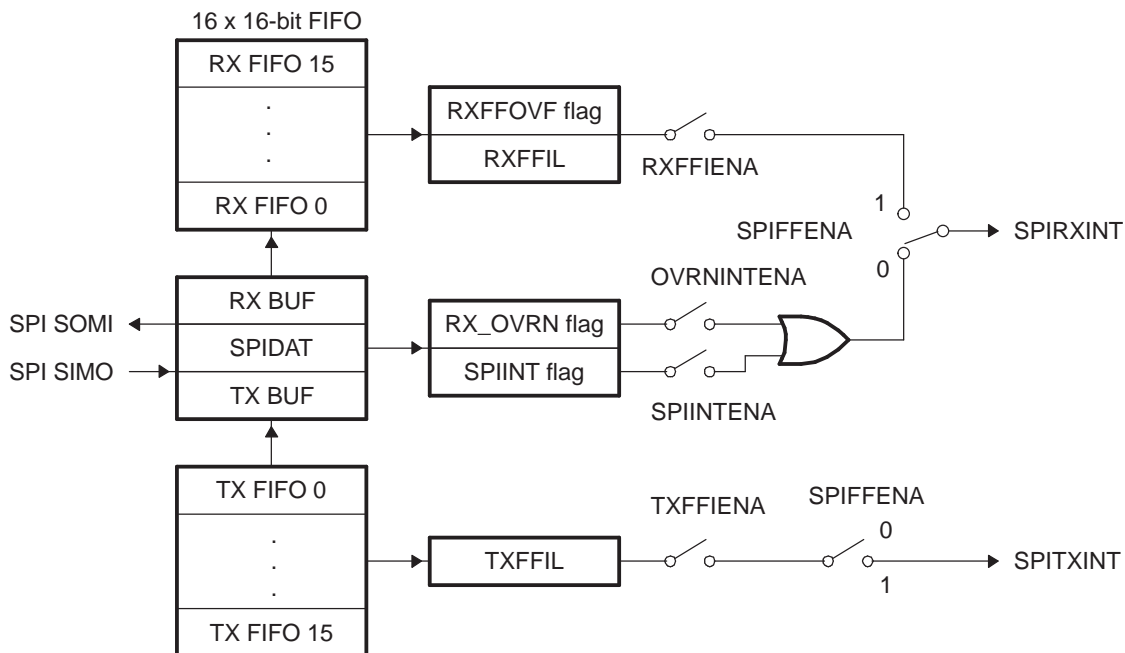

Table 1-4. SPI Interrupt Flag Modes

FIFO Options	SPI Interrupt Source	Interrupt Flags	Interrupt Enables	FIFO Enable SPIFFENA	Interrupt ⁽¹⁾ line
SPI without FIFO					
	Receive overrun	RXOVRN	OVRNINTENA	0	SPIRXINT
	Data receive	SPIINT	SPIINTENA	0	SPIRXINT

⁽¹⁾ In non FIFO mode, SPIRXINT is the same as the SPIINT interrupt in 240x devices.

Table 1-4. SPI Interrupt Flag Modes (continued)

	SPI Interrupt	Interrupt	Interrupt	FIFO Enable	Interrupt⁽¹⁾
<i>SPI FIFO mode</i>	Transmit empty	SPIINT	SPIINTENA	0	SPIRXINT
	FIFO receive	RXFFIL	RXFFIENA	1	SPIRXINT
	Transmit empty	TXFFIL	TXFFIENA	1	SPITXINT

SPI Registers and Waveforms

This section contains the registers, bit descriptions, and waveforms.

Topic	Page
2.1 SPI Control Registers	26
2.2 SPI Example Waveforms	35

2.1 SPI Control Registers

The SPI is controlled and accessed through registers in the control register file.

2.1.1 SPI Configuration Control Register (SPICCR)

SPICCR controls the setup of the SPI for operation.

Figure 2-1. SPI Configuration Control Register (SPICCR) — Address 7040h

7	6	5	4	3	2	1	0
SPI SW Reset	CLOCK POLARITY	Reserved	SPILBK	SPI CHAR3	SPI CHAR2	SPI CHAR1	SPI CHAR0
R/W-0	R/W-0	R-0	R-0	R/W-0	R/W-0	R/W-0	R/W-0

LEGEND: R/W = Read/Write; R = Read only; -n = value after reset

Table 2-1. SPI Configuration Control Register (SPICCR) Field Descriptions

Bit	Field	Value	Description
7	SPI SW RESET	0 1	<p>SPI software reset. When changing configuration, you should clear this bit before the changes and set this bit before resuming operation.</p> <p>0 Initializes the SPI operating flags to the reset condition. Specifically, the RECEIVER OVERRUN Flag bit (SPISTS.7), the SPI INT FLAG bit (SPISTS.6), and the TXBUF FULL Flag bit (SPISTS.5) are cleared. The SPI configuration remains unchanged. If the module is operating as a master, the SPICLK signal output returns to its inactive level.</p> <p>1 SPI is ready to transmit or receive the next character. When the SPI SW RESET bit is a 0, a character written to the transmitter will not be shifted out when this bit is set. A new character must be written to the serial data register.</p>
6	CLOCK POLARITY	0 1	<p>Shift Clock Polarity. This bit controls the polarity of the SPICLK signal. CLOCK POLARITY and CLOCK PHASE (SPICTL.3) control four clocking schemes on the SPICLK pin. See Section 1.4.3.</p> <p>0 Data is output on rising edge and input on falling edge. When no SPI data is sent, SPICLK is at low level. The data input and output edges depend on the value of the CLOCK PHASE bit (SPICTL.3) as follows:</p> <ul style="list-style-type: none"> CLOCK PHASE = 0: Data is output on the rising edge of the SPICLK signal; input data is latched on the falling edge of the SPICLK signal. CLOCK PHASE = 1: Data is output one half-cycle before the first rising edge of the SPICLK signal and on subsequent falling edges of the SPICLK signal; input data is latched on the rising edge of the SPICLK signal. <p>1 Data is output on falling edge and input on rising edge. When no SPI data is sent, SPICLK is at high level. The data input and output edges depend on the value of the CLOCK PHASE bit (SPICTL.3) as follows:</p> <ul style="list-style-type: none"> CLOCK PHASE = 0: Data is output on the falling edge of the SPICLK signal; input data is latched on the rising edge of the SPICLK signal. CLOCK PHASE = 1: Data is output one half-cycle before the first falling edge of the SPICLK signal and on subsequent rising edges of the SPICLK signal; input data is latched on the falling edge of the SPICLK signal.
5	Reserved		Reads return zero; writes have no effect.
4	SPILBK	0 1	<p>SPI loopback. Loop back mode allows module validation during device testing. This mode is valid only in master mode of the SPI.</p> <p>0 SPI loop back mode disabled – default value after reset</p> <p>1 SPI loop back mode enabled, SIMO/SOMI lines are connected internally. Used for module self tests.</p>
3-0	SPI CHAR3 – SPI CHAR0		Character Length Control Bits 3-0. These four bits determine the number of bits to be shifted in or out as a single character during one shift sequence. Table 2-2 lists the character length selected by the bit values.

Table 2-2. Character Length Control Bit Values

SPI CHAR3	SPI CHAR2	SPI CHAR1	SPI CHAR0	Character Length
0	0	0	0	1
0	0	0	1	2
0	0	1	0	3
0	0	1	1	4
0	1	0	0	5
0	1	0	1	6
0	1	1	0	7
0	1	1	1	8
1	0	0	0	9
1	0	0	1	10
1	0	1	0	11
1	0	1	1	12
1	1	0	0	13
1	1	0	1	14
1	1	1	0	15
1	1	1	1	16

2.1.2 SPI Operation Control Register (SPICTL)

SPICTL controls data transmission, the SPI's ability to generate interrupts, the SPICLK phase, and the operational mode (slave or master).

Figure 2-2. SPI Operation Control Register (SPICTL) — Address 7041h

7	6	5	4	3	2	1	0
Reserved			OVERRUN INT ENA	CLOCK PHASE	MASTER/ SLAVE	TALK	SPI INT ENA
R-0			R/W-0	R/W-0	R/W-0	R/W-0	R/W-0

LEGEND: R/W = Read/Write; R = Read only; -n = value after reset

Table 2-3. SPI Operation Control Register (SPICTL) Field Descriptions

Bit	Field	Value	Description
7-5	Reserved		Reads return zero; writes have no effect.
4	Overrun INT ENA	0 1	Overrun Interrupt Enable. Setting this bit causes an interrupt to be generated when the RECEIVER OVERRUN Flag bit (SPISTS.7) is set by hardware. Interrupts generated by the RECEIVER OVERRUN Flag bit and the SPI INT FLAG bit (SPISTS.6) share the same interrupt vector. 0 Disable RECEIVER OVERRUN Flag bit (SPISTS.7) interrupts 1 Enable RECEIVER OVERRUN Flag bit (SPISTS.7) interrupts
3	CLOCK PHASE	0 1	SPI Clock Phase Select. This bit controls the phase of the SPICLK signal. CLOCK PHASE and CLOCK POLARITY (SPICCR.6) make four different clocking schemes possible (see Figure 1-4). When operating with CLOCK PHASE high, the SPI (master or slave) makes the first bit of data available after SPIDAT is written and before the first edge of the SPICLK signal, regardless of which SPI mode is being used. 0 Normal SPI clocking scheme, depending on the CLOCK POLARITY bit (SPICCR.6) 1 SPICLK signal delayed by one half-cycle; polarity determined by the CLOCK POLARITY bit
2	MASTER / SLAVE	0 1	SPI Network Mode Control. This bit determines whether the SPI is a network master or slave. During reset initialization, the SPI is automatically configured as a network slave. 0 SPI configured as a slave. 1 SPI configured as a master.

Table 2-3. SPI Operation Control Register (SPICTL) Field Descriptions (continued)

Bit	Field	Value	Description
1	TALK	0	Master/Slave Transmit Enable. The TALK bit can disable data transmission (master or slave) by placing the serial data output in the high-impedance state. If this bit is disabled during a transmission, the transmit shift register continues to operate until the previous character is shifted out. When the TALK bit is disabled, the SPI is still able to receive characters and update the status flags. TALK is cleared (disabled) by a system reset. Disables transmission: <ul style="list-style-type: none"> Slave mode operation: If not previously configured as a general-purpose I/O pin, the SPISOMI pin will be put in the high-impedance state. Master mode operation: If not previously configured as a general-purpose I/O pin, the SPISIMO pin will be put in the high-impedance state.
		1	Enables transmission For the 4-pin option, ensure to enable the receiver's $\overline{\text{SPISTE}}$ input pin.
0	SPI INT ENA	0	SPI Interrupt Enable. This bit controls the SPI's ability to generate a transmit/receive interrupt. The SPI INT FLAG bit (SPISTS.6) is unaffected by this bit. Disables interrupt
		1	Enables interrupt

2.1.3 SPI Status Register (SPIST)

Figure 2-3. SPI Status Register (SPIST) — Address 7042h

7	6	5	4	0
RECEIVER OVERRUN FLAG ⁽¹⁾⁽²⁾	SPI INT FLAG ⁽¹⁾⁽²⁾	TX BUF FULL FLAG ⁽²⁾	Reserved	
R/C-0	R/C-0	R/C-0	R-0	

LEGEND: R/W = Read/Write; R = Read only; -n = value after reset

(1) The RECEIVER OVERRUN FLAG bit and the SPI INT FLAG bit share the same interrupt vector.

(2) Writing a 0 to bits 5, 6, and 7 has no effect.

Table 2-4. SPI Status Register (SPIST) Field Descriptions

Bit	Field	Value	Description
7	RECEIVER OVERRUN FLAG	0	SPI Receiver Overrun Flag. This bit is a read/clear-only flag. The SPI hardware sets this bit when a receive or transmit operation completes before the previous character has been read from the buffer. The bit indicates that the last received character has been overwritten and therefore lost (when the SPIRXBUF was overwritten by the SPI module before the previous character was read by the user application). The SPI requests one interrupt sequence each time this bit is set if the OVERRUN INT ENA bit (SPICTL.4) is set high. The bit is cleared in one of three ways: <ul style="list-style-type: none"> Writing a 1 to this bit Writing a 0 to SPI SW RESET (SPICCR.7) Resetting the system If the OVERRUN INT ENA bit (SPICTL.4) is set, the SPI requests only one interrupt upon the first occurrence of setting the RECEIVER OVERRUN Flag bit. Subsequent overruns will not request additional interrupts if this flag bit is already set. This means that in order to allow new overrun interrupt requests the user must clear this flag bit by writing a 1 to SPISTS.7 each time an overrun condition occurs. In other words, if the RECEIVER OVERRUN Flag bit is left set (not cleared) by the interrupt service routine, another overrun interrupt will not be immediately re-entered when the interrupt service routine is exited.
		0	Writing a 0 has no effect
		1	Clears this bit. The RECEIVER OVERRUN Flag bit should be cleared during the interrupt service routine because the RECEIVER OVERRUN Flag bit and SPI INT FLAG bit (SPISTS.6) share the same interrupt vector. This will alleviate any possible doubt as to the source of the interrupt when the next byte is received.

Table 2-4. SPI Status Register (SPIST) Field Descriptions (continued)

Bit	Field	Value	Description
6	SPI INT FLAG	0 1	SPI Interrupt Flag. SPI INT FLAG is a read-only flag. The SPI hardware sets this bit to indicate that it has completed sending or receiving the last bit and is ready to be serviced. The received character is placed in the receiver buffer at the same time this bit is set. This flag causes an interrupt to be requested if the SPI INT ENA bit (SPICTL.0) is set. Writing a 0 has no effect This bit is cleared in one of three ways: <ul style="list-style-type: none"> • Reading SPIRXBUF • Writing a 0 to SPI SW RESET (SPICCR.7) • Resetting the system
5	TX BUF FULL FLAG	0 1	SPI Transmit Buffer Full Flag. This read-only bit gets set to 1 when a character is written to the SPI Transmit buffer SPITXBUF. It is cleared when the character is automatically loaded into SPIDAT when the shifting out of a previous character is complete. Writing a 0 has no effect This bit is cleared at reset.
4-0	Reserved	1 0	Reads return zero; writes have no effect.

2.1.4 SPI Baud Rate Register (SPIBRR)

SPIBRR contains the bits used for baud-rate selection.

Figure 2-4. SPI Baud Rate Register (SPIBRR) — Address 7044h

7	6	5	4	3	2	1	0
Reserved	SPI BIT RATE 6	SPI BIT RATE 5	SPI BIT RATE 4	SPI BIT RATE 3	SPI BIT RATE 2	SPI BIT RATE 1	SPI BIT RATE 0
R-0	RW-0	RW-0	RW-0	RW-0	RW-0	RW-0	RW-0

LEGEND: R/W = Read/Write; R = Read only; -n = value after reset

Table 2-5. Field Descriptions

Bit	Field	Value	Description
7	Reserved		Reads return zero; writes have no effect.
6-0	SPI BIT RATE 6– SPI BIT RATE 0		<p>SPI Bit Rate (Baud) Control. These bits determine the bit transfer rate if the SPI is the network master. There are 125 data-transfer rates (each a function of the CPU clock, LSPCLK) that can be selected. One data bit is shifted per SPICLK cycle. (SPICLK is the baud rate clock output on the SPICLK pin.)</p> <p>If the SPI is a network slave, the module receives a clock on the SPICLK pin from the network master; therefore, these bits have no effect on the SPICLK signal. The frequency of the input clock from the master should not exceed the slave SPI's SPICLK signal divided by 4.</p> <p>In master mode, the SPI clock is generated by the SPI and is output on the SPICLK pin. The SPI baud rates are determined by the following formula:</p> <p>For SPIBRR = 3 to 127: $\text{SPI Baud Rate} = \frac{\text{LSPCLK}}{(\text{SPIBRR} + 1)}$</p> <p>For SPIBRR = 0, 1, or 2: $\text{SPI Baud Rate} = \frac{\text{LSPCLK}}{4}$</p> <p>where: LSPCLK = Function of CPU clock frequency X low-speed peripheral clock of the device SPIBRR = Contents of the SPIBRR in the master SPI device</p>

2.1.5 SPI Emulation Buffer Register (SPIRXEMU)

SPIRXEMU contains the received data. Reading SPIRXEMU does not clear the SPI INT FLAG bit (SPISTS.6). This is not a real register but a dummy address from which the contents of SPIRXBUF can be read by the emulator without clearing the SPI INT FLAG.

Figure 2-5. SPI Emulation Buffer Register (SPIRXEMU) — Address 7046h

15	14	13	12	11	10	9	8
ERXB15	ERXB14	ERXB13	ERXB12	ERXB11	ERXB10	ERXB9	ERXB8
R-0	R-0	R-0	R-0	R-0	R-0	R-0	R-0
7	6	5	4	3	2	1	0
ERXB7	ERXB6	ERXB5	ERXB4	ERXB3	ERXB2	ERXB1	ERXB0
R-0	R-0	R-0	R-0	R-0	R-0	R-0	R-0

LEGEND: R/W = Read/Write; R = Read only; -n = value after reset

Table 2-6. SPI Emulation Buffer Register (SPIRXEMU) Field Descriptions

Bit	Field	Value	Description
15	ERXB15– ERXB0		<p>Emulation Buffer Received Data. SPIRXEMU functions almost identically to SPIRXBUF, except that reading SPIRXEMU does not clear the SPI INT FLAG bit (SPISTS.6). Once the SPIDAT has received the complete character, the character is transferred to SPIRXEMU and SPIRXBUF, where it can be read. At the same time, SPI INT FLAG is set.</p> <p>This mirror register was created to support emulation. Reading SPIRXBUF clears the SPI INT FLAG bit (SPISTS.6). In the normal operation of the emulator, the control registers are read to continually update the contents of these registers on the display screen. SPIRXEMU was created so that the emulator can read this register and properly update the contents on the display screen. Reading SPIRXEMU does not clear the SPI INT FLAG bit, but reading SPIRXBUF clears this flag. In other words, SPIRXEMU enables the emulator to emulate the true operation of the SPI more accurately.</p> <p>It is recommended that you view SPIRXEMU in the normal emulator run mode.</p>

2.1.6 SPI Serial Receive Buffer Register (SPIRXBUF)

SPIRXBUF contains the received data. Reading SPIRXBUF clears the SPI INT FLAG bit (SPISTS.6).

Figure 2-6. SPI Serial Receive Buffer Register (SPIRXBUF) — Address 7047h

15	14	13	12	11	10	9	8
RXB15	RXB14	RXB13	RXB12	RXB11	RXB10	RXB9	RXB8
R-0	R-0	R-0	R-0	R-0	R-0	R-0	R-0
7	6	5	4	3	2	1	0
RXB7	RXB6	RXB5	RXB4	RXB3	RXB2	RXB1	RXB0
R-0	R-0	R-0	R-0	R-0	R-0	R-0	R-0

LEGEND: R/W = Read/Write; R = Read only; -n = value after reset

Table 2-7. SPI Serial Receive Buffer Register (SPIRXBUF) Field Descriptions

Bit	Field	Value	Description
15	RXB15 – RXB0		<p>Received Data. Once SPIDAT has received the complete character, the character is transferred to SPIRXBUF, where it can be read. At the same time, the SPI INT FLAG bit (SPISTS.6) is set. Since data is shifted into the SPI's most significant bit first, it is stored right-justified in this register.</p>

2.1.7 SPI Serial Transmit Buffer Register (SPITXBUF)

SPITXBUF stores the next character to be transmitted. Writing to this register sets the TX BUF FULL Flag bit (SPISTS.5). When transmission of the current character is complete, the contents of this register are automatically loaded in SPIDAT and the TX BUF FULL Flag is cleared. If no transmission is currently active, data written to this register falls through into the SPIDAT register and the TX BUF FULL Flag is not set.

In master mode, if no transmission is currently active, writing to this register initiates a transmission in the same manner that writing to SPIDAT does.

Figure 2-7. SPI Serial Transmit Buffer Register (SPITXBUF) — Address 7048h

15	14	13	12	11	10	9	8
TXB15	TXB14	TXB13	TXB12	TXB11	TXB10	TXB9	TXB8
R-0	R-0	R-0	R-0	R-0	R-0	R-0	R-0
7	6	5	4	3	2	1	0
TXB7	TXB6	TXB5	TXB4	TXB3	TXB2	TXB1	TXB0
R-0	R-0	R-0	R-0	R-0	R-0	R-0	R-0

LEGEND: R/W = Read/Write; R = Read only; -n = value after reset

Table 2-8. SPI Serial Transmit Buffer Register (SPITXBUF) Field Descriptions

Bit	Field	Value	Description
15	TXB15 – TXB0		Transmit Data Buffer. This is where the next character to be transmitted is stored. When the transmission of the current character has completed, if the TX BUF FULL Flag bit is set, the contents of this register is automatically transferred to SPIDAT, and the TX BUF FULL Flag is cleared. Writes to SPITXBUF must be left-justified.

2.1.8 SPI Serial Data Register (SPIDAT)

SPIDAT is the transmit/receive shift register. Data written to SPIDAT is shifted out (MSB) on subsequent SPICLK cycles. For every bit (MSB) shifted out of the SPI, a bit is shifted into the LSB end of the shift register.

Figure 2-8. SPI Serial Data Register (SPIDAT) — Address 7049h

15	14	13	12	11	10	9	8
SDAT15	SDAT14	SDAT13	SDAT12	SDAT11	SDAT10	SDAT9	SDAT8
R-0	R-0	R-0	R-0	R-0	R-0	R-0	R-0
7	6	5	4	3	2	1	0
SDAT7	SDAT6	SDAT5	SDAT4	SDAT3	SDAT2	SDAT1	SDAT0
R-0	R-0	R-0	R-0	R-0	R-0	R-0	R-0

LEGEND: R/W = Read/Write; R = Read only; -n = value after reset

Table 2-9. SPI Serial Data Register (SPIDAT) Field Descriptions

Bit	Field	Value	Description
15	SDAT15 – SDAT0		Serial data. Writing to the SPIDAT performs two functions: <ul style="list-style-type: none"> It provides data to be output on the serial output pin if the TALK bit (SPICTL.1) is set. When the SPI is operating as a master, a data transfer is initiated. When initiating a transfer, see the CLOCK POLARITY bit (SPICCR.6) described in Section 2.1.1 and the CLOCK PHASE bit (SPICTL.3) described in Section 2.1.2, for the requirements. In master mode, writing dummy data to SPIDAT initiates a receiver sequence. Since the data is not hardware-justified for characters shorter than sixteen bits, transmit data must be written in left-justified form, and received data read in right-justified form.

2.1.9 SPI FIFO Transmit, Receive, and Control Registers

Figure 2-9. SPI FIFO Transmit (SPIFFTX) Register – Address 704Ah

15	14	13	12	11	10	9	8
SPIRST	SPIFFENA	TXFIFO	TXFFST4	TXFFST3	TXFFST2	TXFFST1	TXFFST0
R/W-1	R/W-0	R/W-1	R-0	R-0	R-0	R-0	R-0
7	6	5	4	3	2	1	0
TXFFINT Flag	TXFFINT CLR	TXFFIENA	TXFFIL4	TXFFIL3	TXFFIL2	TXFFIL1	TXFFIL0
R/W-0	W-0	R/W-0	R/W-0	R/W-0	R/W-0	R/W-0	R/W-0

LEGEND: R/W = Read/Write; R = Read only; -n = value after reset

Table 2-10. SPI FIFO Transmit (SPIFFTX) Register Field Descriptions

Bit	Field	Value	Description
15	SPIRST	0 1	SPI reset Write 0 to reset the SPI transmit and receive channels. The SPI FIFO register configuration bits will be left as is. SPI FIFO can resume transmit or receive. No effect to the SPI registers bits.
14	SPIFFENA	0 1	SPI FIFO enhancements enable SPI FIFO enhancements are disabled SPI FIFO enhancements are enabled
13	TXFIFO Reset	0 1	Transmit FIFO reset Write 0 to reset the FIFO pointer to zero, and hold in reset. Re-enable Transmit FIFO operation
12-8	TXFFST4-0	00000 00001 00010 00011	Transmit FIFO status Transmit FIFO is empty. Transmit FIFO has 1 word. Transmit FIFO has 2 words. Transmit FIFO has 3 words.
7	TXFFINT	0 1	TXFIFO interrupt TXFIFO interrupt has not occurred, This is a read-only bit. TXFIFO interrupt has occurred, This is a read-only bit.
6	TXFFINT CLR	0 1	TXFIFO clear Write 0 has no effect on TXFIFINT flag bit, Bit reads back a zero. Write 1 to clear TXFFINT flag in bit 7.
5	TXFFIENA	0 1	TX FIFO interrupt enable TX FIFO interrupt based on TXFFIVL match (less than or equal to) will be disabled . TX FIFO interrupt based on TXFFIVL match (less than or equal to) will be enabled.
4-0	TXFFIL4-0	00000	TXFFIL4-0 transmit FIFO interrupt level bits. Transmit FIFO will generate interrupt when the FIFO status bits (TXFFST4-0) and FIFO level bits (TXFFIL4-0) match (less than or equal to). Default value is 0x00000.

Figure 2-10. SPI FIFO Receive (SPIFFRX) Register – Address 704Bh

15	14	13	12	11	10	9	8
RXFFOVF Flag	RXFFOVF CLR	RXFIFO Reset	RXFFST4	RXFFST3	RXFFST2	RXFFST1	RXFFST0
R-0	W-0	R/W-1	R-0	R-0	R-0	R-0	R-0
7	6	5	4	3	2	1	0
RXFFINT Flag	RXFFINT CLR	RXFFIENA	RXFFIL4	RXFFIL3	RXFFIL2	RXFFIL1	RXFFIL0
R-0	W-0	R/W-0	R/W-1	R/W-1	R/W-1	R/W-1	R/W-1

LEGEND: R/W = Read/Write; R = Read only; -n = value after reset

Table 2-11. SPI FIFO Receive (SPIFFRX) Register Field Descriptions

Bit	Field	Value	Description
15	RXFFOVF	0 1	Receive FIFO overflow flag Receive FIFO has not overflowed. This is a read-only bit. Receive FIFO has overflowed, read-only bit. More than 16 words have been received in to the FIFO, and the first received word is lost.
14	RXFFOVF CLR	0 1	Receive FIFO overflow clear Write 0 does not affect RXFFOVF flag bit, Bit reads back a zero Write 1 to clear RXFFOVF flag in bit 15
13	RXFIFO Reset	0 1	Receive FIFO reset Write 0 to reset the FIFO pointer to zero, and hold in reset. Re-enable receive FIFO operation
12-8	RXFFST4-0	00000 00001 00010 00011 0xxxx 10000	Receive FIFO Status Receive FIFO is empty. Receive FIFO has 1 word. Receive FIFO has 2 words. Receive FIFO has 3 words. Receive FIFO has x words. Receive FIFO has 16 words. Receive FIFO has a maximum of 16 words.
7	RXFFINT	0 1	Receive FIFO interrupt RXFIFO interrupt has not occurred. This is a read-only bit. RXFIFO interrupt has occurred. This is a read-only bit.
6	RXFFINT CLR	0 1	Receive FIFO interrupt clear Write 0 has no effect on RXFIFINT flag bit, Bit reads back a zero. Write 1 to clear RXFFINT flag in bit 7.
5	RXFFIENA	0 1	RX FIFO interrupt enable RX FIFO interrupt based on RXFFIL match (greater than or equal to) will be disabled. RX FIFO interrupt based on RXFFIL match (greater than or equal to) will be enabled.
4-0	RXFFIL4-0	11111	Receive FIFO interrupt level bits Receive FIFO generates an interrupt when the FIFO status bits (RXFFST4-0) are greater than or equal to the FIFO level bits (RXFFIL4-0). The default value of these bits after reset is 11111. This avoids frequent interrupts after reset, as the receive FIFO will be empty most of the time.

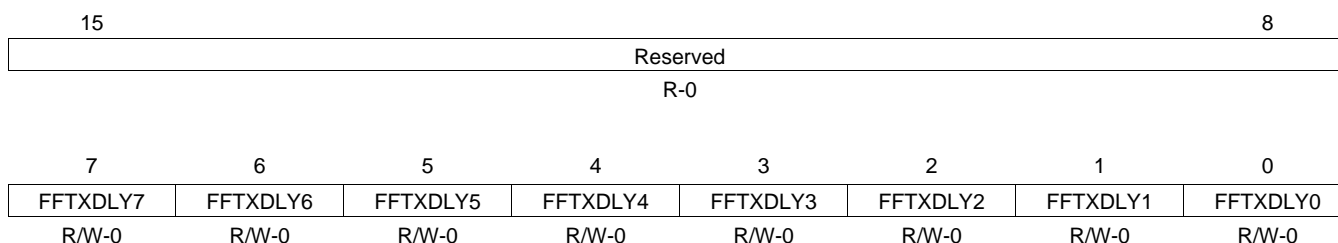
Figure 2-11. SPI FIFO Control (SPIFFCT) Register – Address 704Ch

LEGEND: R/W = Read/Write; R = Read only; -n = value after reset

Table 2-12. SPI FIFO Control (SPIFFCT) Register Field Descriptions

Bit	Field	Value	Description
15-8	Reserved		
7-0	FFTXDLY7-0	0	FIFO transmit delay bits These bits define the delay between every transfer from FIFO transmit buffer to transmit shift register. The delay is defined in number SPI serial clock cycles. The 8-bit register could define a minimum delay of 0 serial clock cycles and a maximum of 255 serial clock cycles.
		1	In FIFO mode, the buffer (TXBUF) between the shift register and the FIFO should be filled only after the shift register has completed shifting of the last bit. This is required to pass on the delay between transfers to the data stream. In the FIFO mode TXBUF should not be treated as one additional level of buffer.

2.1.10 SPI Priority Control Register (SPIPRI)

Table 2-13. SPI Priority Control Register (SPIPRI) Field Descriptions

Bit	Field	Value	Description
7-6			Reads return zero; writes have no effect.
5-4	SPI SUSP SOFT SPI SUSP FREE	<p>0 0</p> <p>1 0</p> <p>x 1</p>	<p>These bits determine what occurs when an emulation suspend occurs (for example, when the debugger hits a breakpoint). The peripheral can continue whatever it is doing (free-run mode) or, if in stop mode, it can either stop immediately or stop when the current operation (the current receive/transmit sequence) is complete.</p> <p>0 0 Transmission stops after midway in the bit stream while TSUSPEND is asserted. Once TSUSPEND is deasserted without a system reset, the remainder of the bits pending in the DATBUF are shifted. Example: If SPIDAT has shifted 3 out of 8 bits, the communication freezes right there. However, if TSUSPEND is later deasserted without resetting the SPI, SPI starts transmitting from where it had stopped (fourth bit in this case) and will transmit 8 bits from that point. The SCI module operates differently.</p> <p>1 0 If the emulation suspend occurs before the start of a transmission, (i.e., before the first SPICLK pulse) then the transmission will not occur. If the emulation suspend occurs after the start of a transmission, then the data will be shifted out to completion. When the start of transmission occurs is dependent on the baud rate used.</p> <p><i>Standard SPI mode:</i> Stop after transmitting the words in the shift register and buffer. That is, after TXBUF and SPIDAT are empty.</p> <p><i>In FIFO mode:</i> Stop after transmitting the words in the shift register and buffer. That is, after TX FIFO and SPIDAT are empty.</p> <p>x 1 Free run, continue SPI operation regardless of suspend or when the suspend occurred.</p>

2.2 SPI Example Waveforms

Figure 2-12. CLOCK POLARITY = 0, CLOCK PHASE = 0 (All data transitions are during the rising edge, non-delayed clock. Inactive level is low.)

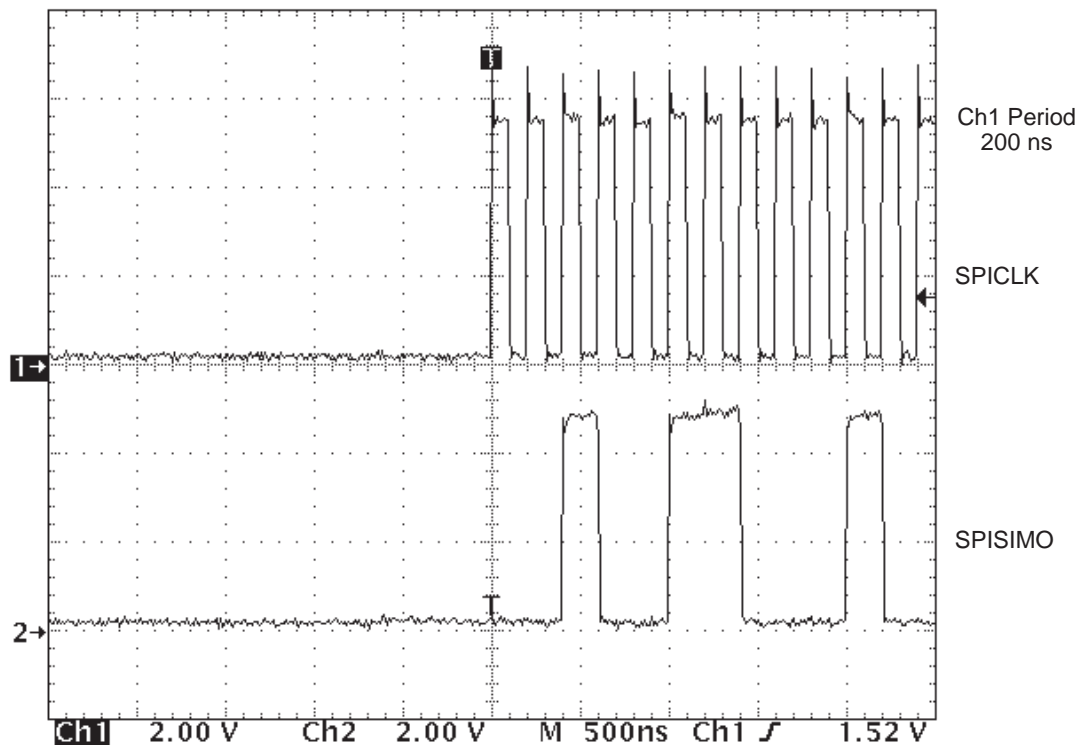

Figure 2-13. CLOCK POLARITY = 0, CLOCK PHASE = 1 (All data transitions are during the rising edge, but delayed by half clock cycle. Inactive level is low.)

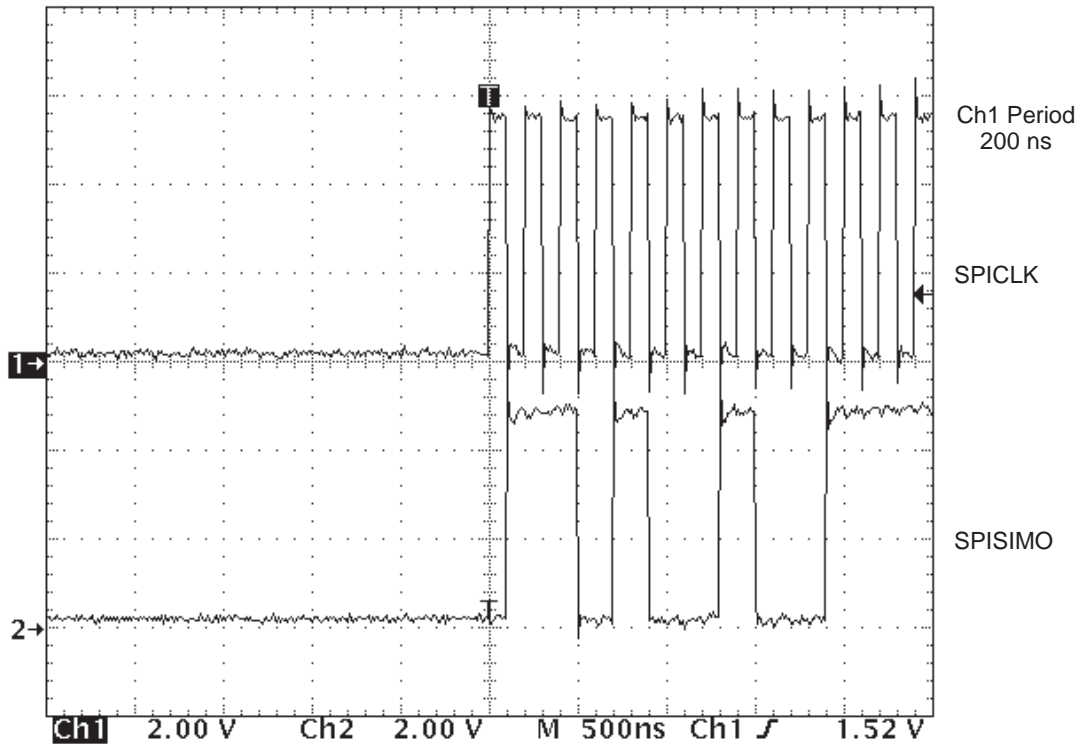

Figure 2-14. CLOCK POLARITY = 1, CLOCK PHASE = 0 (All data transitions are during the falling edge. Inactive level is high.)

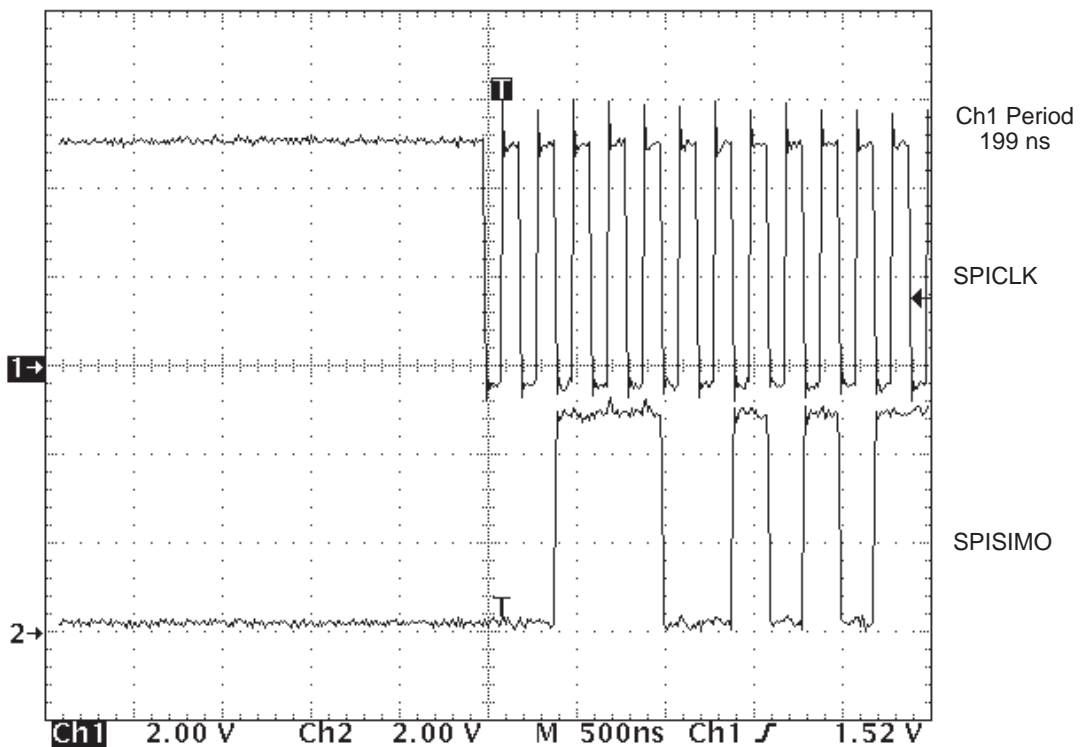

Figure 2-15. CLOCK POLARITY = 1, CLOCK PHASE = 1 (All data transitions are during the falling edge, but delayed by half clock cycle. Inactive level is high.)

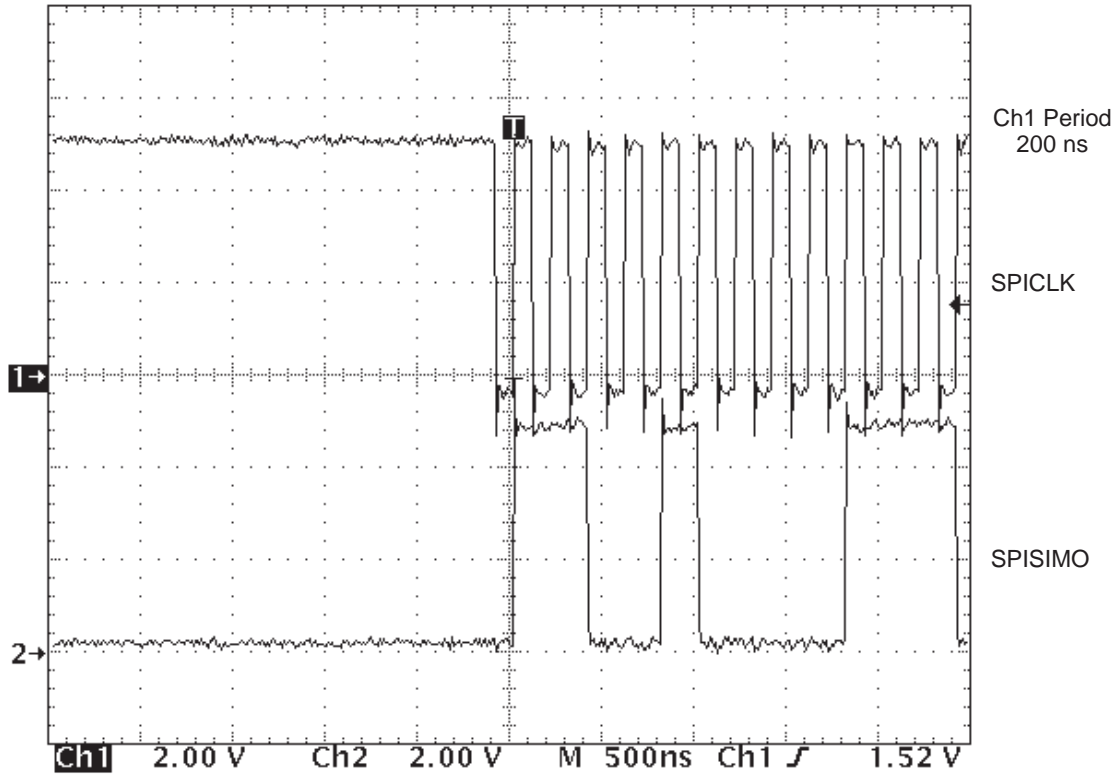

Figure 2-16. $\overline{\text{SPISTE}}$ Behavior in Master Mode (Master lowers $\overline{\text{SPISTE}}$ during the entire 16 bits of transmission.)

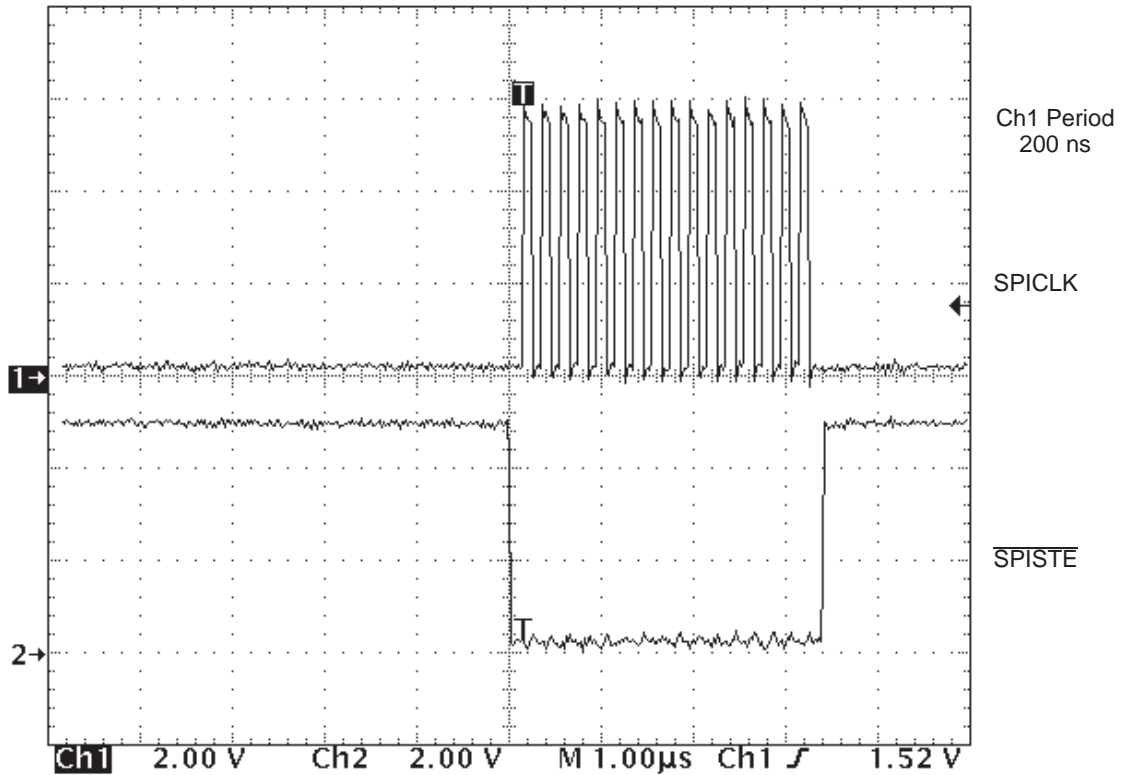
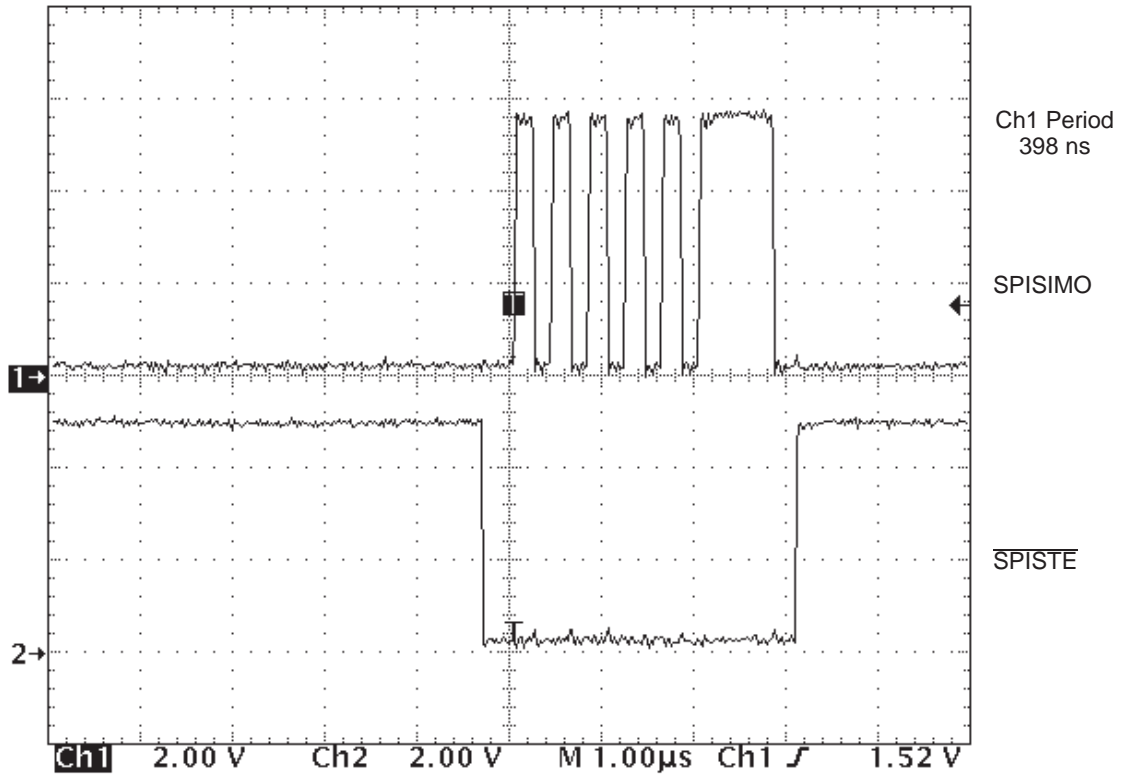

Figure 2-17. $\overline{\text{SPISTE}}$ Behavior in Slave Mode (Slave's $\overline{\text{SPISTE}}$ is lowered during the entire 16 bits of transmission.)



Revision History

Technical changes made in this revision are shown in .

Table A-1. Changes in Revision A

Location	Additions, Deletions, Modifications
Table 2-11	Added: 0xxxx Receive FIFO has x words. 10000: Receive FIFO has 16 words. In the RXFFIENA row, “RXFFIVL” changed to “RXFFIL”, and “less than or equal to” changed to “greater than or equal to”. Revised the description for bits 4-0 (RXFFIL)

IMPORTANT NOTICE

Texas Instruments Incorporated and its subsidiaries (TI) reserve the right to make corrections, modifications, enhancements, improvements, and other changes to its products and services at any time and to discontinue any product or service without notice. Customers should obtain the latest relevant information before placing orders and should verify that such information is current and complete. All products are sold subject to TI's terms and conditions of sale supplied at the time of order acknowledgment.

TI warrants performance of its hardware products to the specifications applicable at the time of sale in accordance with TI's standard warranty. Testing and other quality control techniques are used to the extent TI deems necessary to support this warranty. Except where mandated by government requirements, testing of all parameters of each product is not necessarily performed.

TI assumes no liability for applications assistance or customer product design. Customers are responsible for their products and applications using TI components. To minimize the risks associated with customer products and applications, customers should provide adequate design and operating safeguards.

TI does not warrant or represent that any license, either express or implied, is granted under any TI patent right, copyright, mask work right, or other TI intellectual property right relating to any combination, machine, or process in which TI products or services are used. Information published by TI regarding third-party products or services does not constitute a license from TI to use such products or services or a warranty or endorsement thereof. Use of such information may require a license from a third party under the patents or other intellectual property of the third party, or a license from TI under the patents or other intellectual property of TI.

Reproduction of TI information in TI data books or data sheets is permissible only if reproduction is without alteration and is accompanied by all associated warranties, conditions, limitations, and notices. Reproduction of this information with alteration is an unfair and deceptive business practice. TI is not responsible or liable for such altered documentation. Information of third parties may be subject to additional restrictions.

Resale of TI products or services with statements different from or beyond the parameters stated by TI for that product or service voids all express and any implied warranties for the associated TI product or service and is an unfair and deceptive business practice. TI is not responsible or liable for any such statements.

TI products are not authorized for use in safety-critical applications (such as life support) where a failure of the TI product would reasonably be expected to cause severe personal injury or death, unless officers of the parties have executed an agreement specifically governing such use. Buyers represent that they have all necessary expertise in the safety and regulatory ramifications of their applications, and acknowledge and agree that they are solely responsible for all legal, regulatory and safety-related requirements concerning their products and any use of TI products in such safety-critical applications, notwithstanding any applications-related information or support that may be provided by TI. Further, Buyers must fully indemnify TI and its representatives against any damages arising out of the use of TI products in such safety-critical applications.

TI products are neither designed nor intended for use in military/aerospace applications or environments unless the TI products are specifically designated by TI as military-grade or "enhanced plastic." Only products designated by TI as military-grade meet military specifications. Buyers acknowledge and agree that any such use of TI products which TI has not designated as military-grade is solely at the Buyer's risk, and that they are solely responsible for compliance with all legal and regulatory requirements in connection with such use.

TI products are neither designed nor intended for use in automotive applications or environments unless the specific TI products are designated by TI as compliant with ISO/TS 16949 requirements. Buyers acknowledge and agree that, if they use any non-designated products in automotive applications, TI will not be responsible for any failure to meet such requirements.

Following are URLs where you can obtain information on other Texas Instruments products and application solutions:

Products

Amplifiers	amplifier.ti.com
Data Converters	dataconverter.ti.com
DLP® Products	www.dlp.com
DSP	dsp.ti.com
Clocks and Timers	www.ti.com/clocks
Interface	interface.ti.com
Logic	logic.ti.com
Power Mgmt	power.ti.com
Microcontrollers	microcontroller.ti.com
RFID	www.ti-rfid.com
RF/IF and ZigBee® Solutions	www.ti.com/lprf

Applications

Audio	www.ti.com/audio
Automotive	www.ti.com/automotive
Broadband	www.ti.com/broadband
Digital Control	www.ti.com/digitalcontrol
Medical	www.ti.com/medical
Military	www.ti.com/military
Optical Networking	www.ti.com/opticalnetwork
Security	www.ti.com/security
Telephony	www.ti.com/telephony
Video & Imaging	www.ti.com/video
Wireless	www.ti.com/wireless

Mailing Address: Texas Instruments, Post Office Box 655303, Dallas, Texas 75265
Copyright © 2009, Texas Instruments Incorporated