

PMP9765 - Automotive USB Charging Port Supply Reference Design with Charging Controller and Cable Compensation

USB charging ports in automotive applications are usually supplied directly from the car battery rail. To generate the required 5-V charging voltage a DC-DC converter is required. This DC-DC converter can be located directly at the USB-port or remote in an ECU. In case the DC-DC converter is in the remote ECU the USB port may be connected with a longer cable. Having high charging current flowing through the long cable may cause significant voltage drop from the DC-DC regulator to the port. This voltage drop needs to be compensated to be able to offer a USB charging voltage compliant power supply at the location of the USB-port. The measurement results documented in this test report show the performance of a reference design addressing this problem.

1 Overview

The reference design provides a complete power supply solution, supplying a USB charging port which is connected with a longer cable. This power supply solution can be powered directly from the car battery rail. It is based on a high efficient step down converter, the TPS62130 which can provide up to 3 A output current. The input of the step down converter is connected to the car battery rail using an overvoltage protection circuit. This will ensure that any overvoltage condition at the input can not cause damage at the step down converter and its connected circuits. The output of the step down converter is supplying an USB charging controller, the TPS2549, which controls the USB charging port. The charging controller detects the device connected to the USB charging port and controls the power accordingly. It also provides short circuit protection for the power connections of the USB-port. More details on the different control features and configuration options of the TPS2549 charge controller are described in its [datasheet](#). The structure of the circuit is shown in [Figure 1](#).

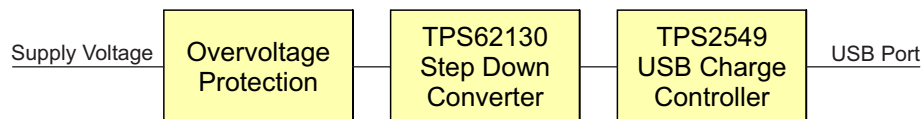

Figure 1. Block Diagram

The objective of the circuit is to provide an accurate 5-V supply at the end of a cable for a load which can vary between 0 A and 2.5 A. The cable connection in this example is 5 meters long (2 x 2.5 m) with a cross section of 0.5 mm². This circuit typically can be used to power a remote USB plug in a car which can be used for USB communication to the media hub and in addition to charge a USB device with 2 A of charge current. An example of an implementation is found in the [TI reference designs library](#).

2 Measurements

In this section measurement results for the proposed circuit are documented. Details on how to configure the individual devices in this circuit can be found in their respective datasheet ([TPS62130](#), [TPS2549](#)).

The circuit is designed to withstand up to 40-V supply voltage at its input and operate at supply voltages from 5 V up to 17 V. The output is regulated at 5 V assuming it is connected with a cable which is 5 m long (2 x 2.5 m) with a cross section of 0.5 mm². The maximum output current is set to 2.5 A, above that current short circuit protection is active and disconnecting the USB-port.

2.1 Overvoltage protection

To achieve the high input voltage rating the circuit uses an overvoltage protection at its input. This overvoltage protection circuit is disconnecting the supply voltage at the input of the circuit and disabling the DC-DC converter, in case the supply voltage exceeds the maximum operating input voltage of the DC-DC converter. Details on how this overvoltage protection circuit is designed can be found in the application note [SLVA664](#). [Figure 2](#) shows the complete overvoltage protection circuit.

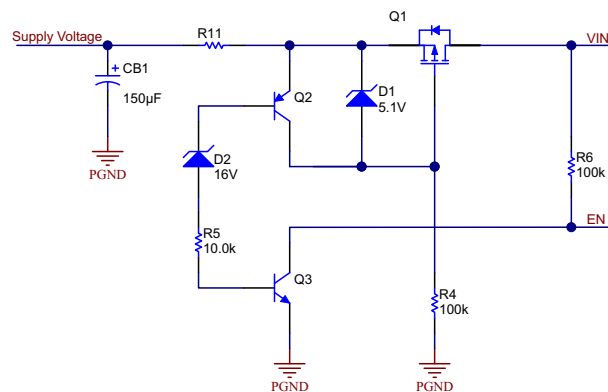

Figure 2. Circuit Schematic

[Figure 3](#) shows the behavior of the circuit during a line transient into an overvoltage condition. If the supply voltage decreases below 17 V the overvoltage protection turns the FET Q1 on and sets the EN signal high. This causes its output voltage (signal VIN) to increase and the connected TPS62130 converter starts operating. After the softstart of the converter the output voltage of the converter is regulated to its set 5 V.

As soon as the supply voltage is increasing above 17 V the overvoltage protection circuit turns off the FET Q1 and sets EN low which disables the TPS62130.

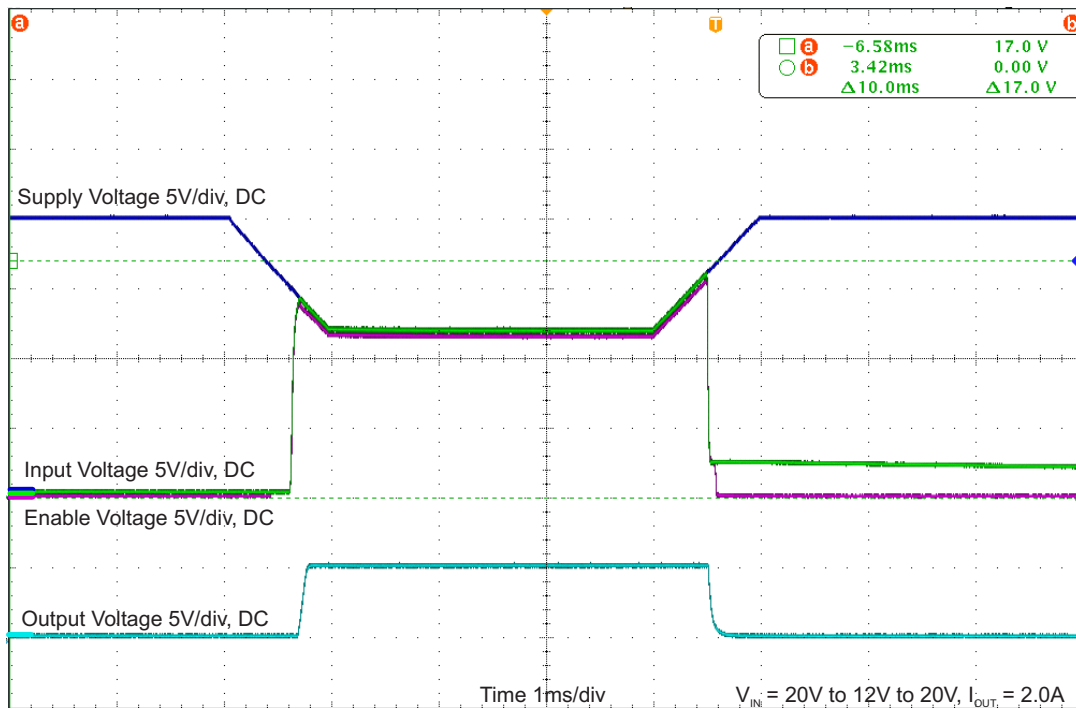

Figure 3. Circuit Schematic

2.2 Power Stage

The power stage consists of the DC-DC converter U1 (TPS62130) and the USB charging controller U2 (TPS2549) as shown in Figure 4. The TPS62130 is configured to regulate 5 V at its output. This is set by a resistive divider consisting of R1,R2 and R3. Using those 3 resistors for the feedback allows to connect the CS input of the TPS2549 between R1 and R2. This enables the TPS2549 to sink current flowing through the upper resistor R1 in the feedback divider. By sinking this additional current flowing through R1 the TPS2549 increases the voltage drop across this resistor and with this it increases the output voltage of the TPS2549. The current flowing into CS is controlled proportional to the load current flowing through the TPS2549 from its IN pin to its OUT pin. This way a voltage drop across a connected cable can be compensated by feeding in a higher voltage into the cable.

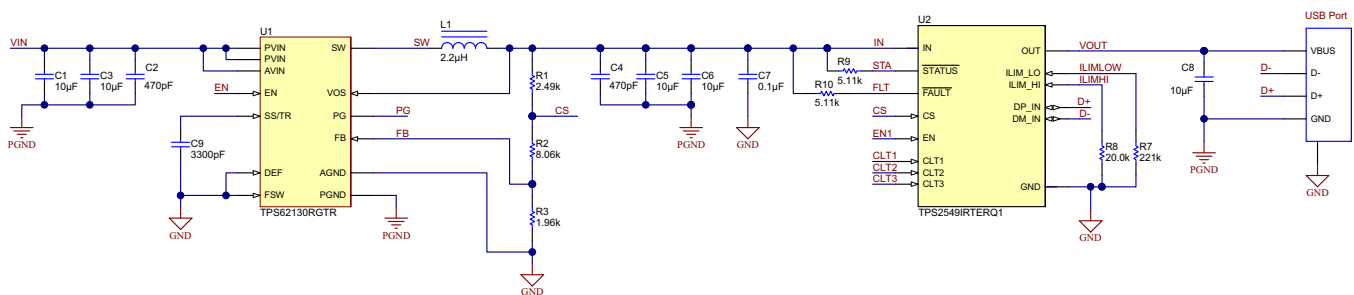

Figure 4. Power Stage Circuit Schematic

2.2.1 DC regulation

Figure 5 shows the resulting DC regulation at the output of the TPS2549 charging controller (VOUT) and at the end of the cable where the USB-plug is connected.

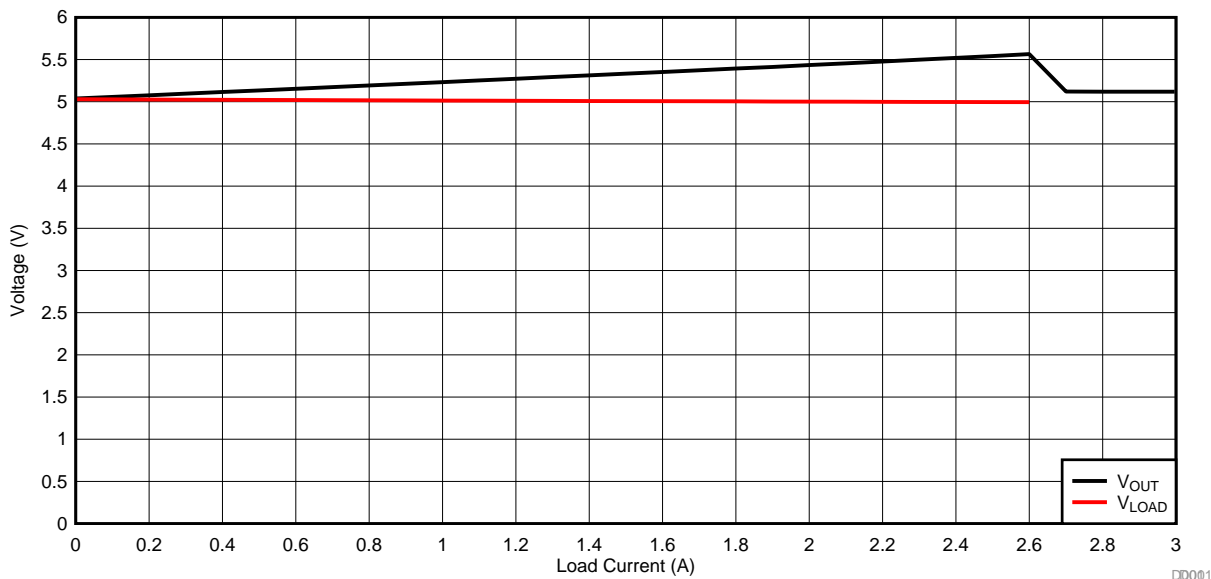

Figure 5. DC Regulation

Figure 6 shows the relative voltage error of the DC voltage regulation referenced to 5 V. Of course the regulation error is significant and increasing with current at the output of the circuit, but this makes the error at the USB-plug at the load side almost negligible. The error at the plug is less than 1% at the highest output current.

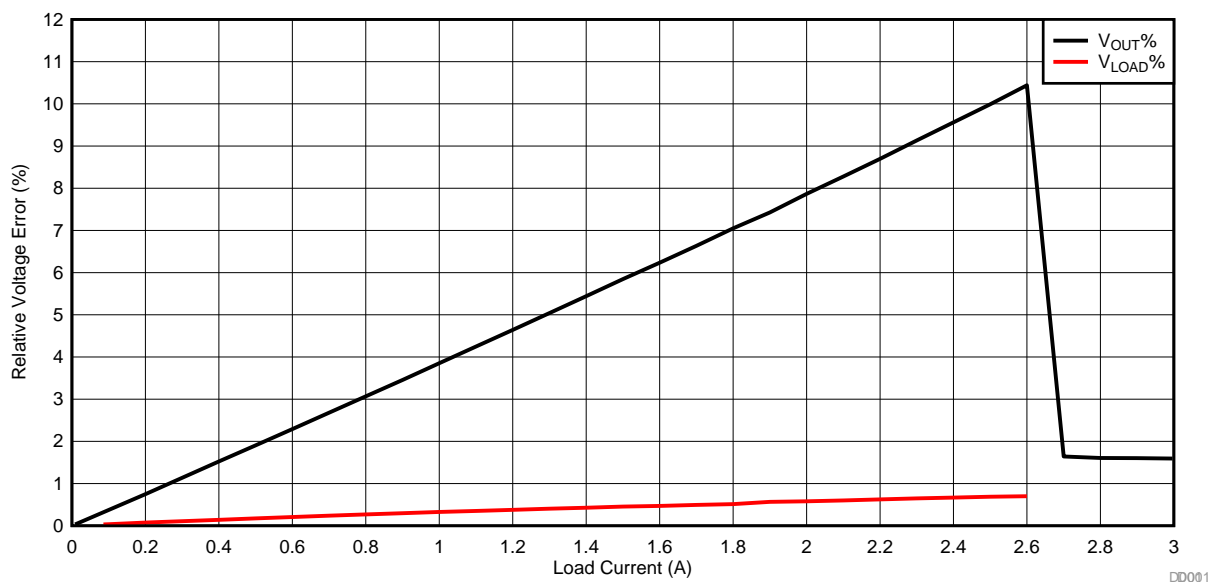

Figure 6. DC Regulation Error

2.2.2 Transients

Figure 7 shows the dynamic performance of the implemented control circuit. It is measured during a fast load transient from 0.2 A to 1.8 A and back. When the current is increasing there is a voltage drop at the output voltage and even higher at the load voltage. The voltage drop at the output voltage is detected by the control circuit and compensated. Removing the load causes a minor overshoot at the output voltage, and due to the compensation voltage which is still high, the load voltage has a higher overshoot. This also is detected by the control circuit and compensated accordingly.

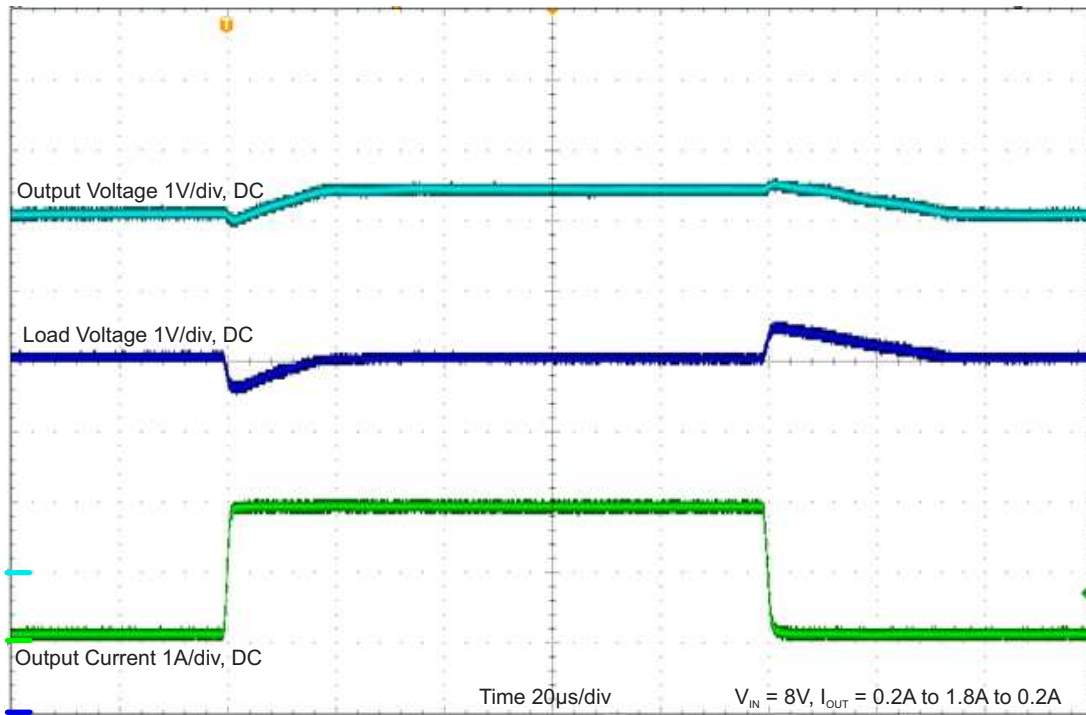

Figure 7. Load Transient

2.2.3 Startup and Shutdown

Figure 8 shows the behavior of the circuit at startup and shutdown. This has been tested by applying supply voltage and removing it. During this test the load is always connected.

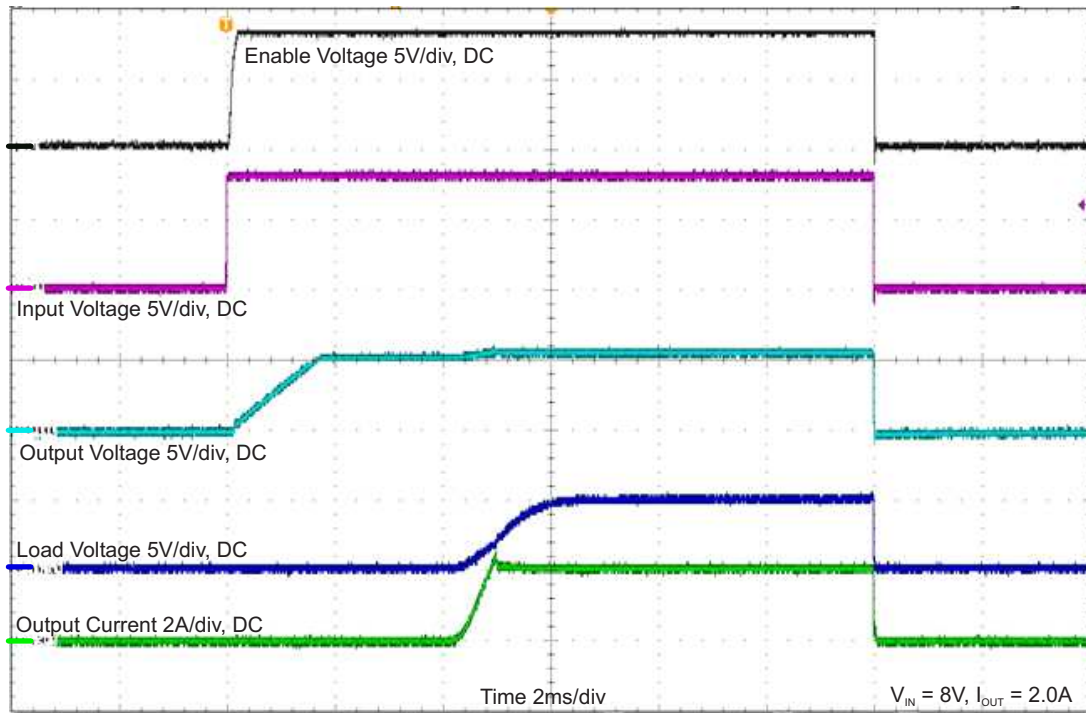

Figure 8. Startup and Shutdown

As soon as the circuit is powered properly the TPS62130 starts to operate. After the softstart it regulates its output voltage to 5 V. This output voltage supplies the TPS2549 which then starts to operate as well. The TPS2549 starts to supply the load by smoothly turning on the output and ramping up the load current. When the nominal load current is reached the TPS2549 also increases the output voltage of the TPS62130 to compensate for the voltage drop across the cable.

After removing the supply voltage all currents and voltages immediately drop to zero.

IMPORTANT NOTICE

Texas Instruments Incorporated and its subsidiaries (TI) reserve the right to make corrections, enhancements, improvements and other changes to its semiconductor products and services per JESD46, latest issue, and to discontinue any product or service per JESD48, latest issue. Buyers should obtain the latest relevant information before placing orders and should verify that such information is current and complete. All semiconductor products (also referred to herein as "components") are sold subject to TI's terms and conditions of sale supplied at the time of order acknowledgment.

TI warrants performance of its components to the specifications applicable at the time of sale, in accordance with the warranty in TI's terms and conditions of sale of semiconductor products. Testing and other quality control techniques are used to the extent TI deems necessary to support this warranty. Except where mandated by applicable law, testing of all parameters of each component is not necessarily performed.

TI assumes no liability for applications assistance or the design of Buyers' products. Buyers are responsible for their products and applications using TI components. To minimize the risks associated with Buyers' products and applications, Buyers should provide adequate design and operating safeguards.

TI does not warrant or represent that any license, either express or implied, is granted under any patent right, copyright, mask work right, or other intellectual property right relating to any combination, machine, or process in which TI components or services are used. Information published by TI regarding third-party products or services does not constitute a license to use such products or services or a warranty or endorsement thereof. Use of such information may require a license from a third party under the patents or other intellectual property of the third party, or a license from TI under the patents or other intellectual property of TI.

Reproduction of significant portions of TI information in TI data books or data sheets is permissible only if reproduction is without alteration and is accompanied by all associated warranties, conditions, limitations, and notices. TI is not responsible or liable for such altered documentation. Information of third parties may be subject to additional restrictions.

Resale of TI components or services with statements different from or beyond the parameters stated by TI for that component or service voids all express and any implied warranties for the associated TI component or service and is an unfair and deceptive business practice. TI is not responsible or liable for any such statements.

Buyer acknowledges and agrees that it is solely responsible for compliance with all legal, regulatory and safety-related requirements concerning its products, and any use of TI components in its applications, notwithstanding any applications-related information or support that may be provided by TI. Buyer represents and agrees that it has all the necessary expertise to create and implement safeguards which anticipate dangerous consequences of failures, monitor failures and their consequences, lessen the likelihood of failures that might cause harm and take appropriate remedial actions. Buyer will fully indemnify TI and its representatives against any damages arising out of the use of any TI components in safety-critical applications.

In some cases, TI components may be promoted specifically to facilitate safety-related applications. With such components, TI's goal is to help enable customers to design and create their own end-product solutions that meet applicable functional safety standards and requirements. Nonetheless, such components are subject to these terms.

No TI components are authorized for use in FDA Class III (or similar life-critical medical equipment) unless authorized officers of the parties have executed a special agreement specifically governing such use.

Only those TI components which TI has specifically designated as military grade or "enhanced plastic" are designed and intended for use in military/aerospace applications or environments. Buyer acknowledges and agrees that any military or aerospace use of TI components which have **not** been so designated is solely at the Buyer's risk, and that Buyer is solely responsible for compliance with all legal and regulatory requirements in connection with such use.

TI has specifically designated certain components as meeting ISO/TS16949 requirements, mainly for automotive use. In any case of use of non-designated products, TI will not be responsible for any failure to meet ISO/TS16949.

Products

Audio	www.ti.com/audio
Amplifiers	amplifier.ti.com
Data Converters	dataconverter.ti.com
DLP® Products	www.dlp.com
DSP	dsp.ti.com
Clocks and Timers	www.ti.com/clocks
Interface	interface.ti.com
Logic	logic.ti.com
Power Mgmt	power.ti.com
Microcontrollers	microcontroller.ti.com
RFID	www.ti-rfid.com
OMAP Applications Processors	www.ti.com/omap
Wireless Connectivity	www.ti.com/wirelessconnectivity

Applications

Automotive and Transportation	www.ti.com/automotive
Communications and Telecom	www.ti.com/communications
Computers and Peripherals	www.ti.com/computers
Consumer Electronics	www.ti.com/consumer-apps
Energy and Lighting	www.ti.com/energy
Industrial	www.ti.com/industrial
Medical	www.ti.com/medical
Security	www.ti.com/security
Space, Avionics and Defense	www.ti.com/space-avionics-defense
Video and Imaging	www.ti.com/video

TI E2E Community

e2e.ti.com