

## **Design PMP40100 Test Results**

---

### **1 GENERAL**

#### **1.1 PURPOSE**

The PMP40100 is an isolated flyback solution which accepts an input voltage of 5V to 36V and provides multiple output rails to the load. The reference design using LM3481 flyback-CCM topology features, multiple isolated output rails, good line and load regulation, good thermal performance. The design also integrates transformer winding in PCB which significantly reduces the PCB board dimension.

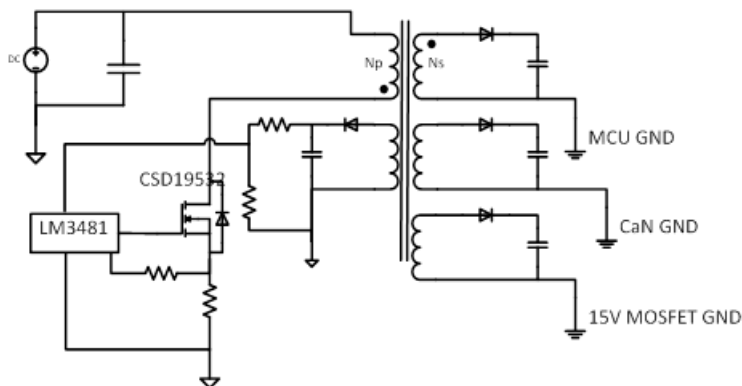
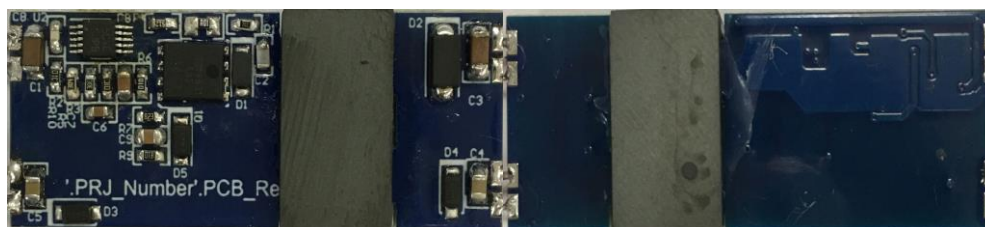

#### **1.2 REFERENCE DOCUMENTATION**

Schematic: PMP40100E1((No Variations))\_Sch.PDF

PCB: PMP40100\_PCB\_.PcbDoc

BOM: PMP40100E1((No Variations))\_TI-BOM.pdf

#### **1.3 TEST EQUIPMENTS**

Multi-meter (current): Fluke 287C\*2

Multi-meter (voltage): Agilent 34401A

E-Load: Chroma 63101 module

### **2 Performance data and waveform**

#### **2.1 Three Output Rail Cross Regulation**

Vin=5V	6V(CaN)(mA)	Vout1	6V(MCU)(mA)	Vout2	15V(Driver)(mA)	Vout3
	10	6.499	10	6.484	10	16.594
	10	6.405	10	6.383	80	15.672
	10	6.328	300	5.609	10	15.953
	10	6.238	300	5.617	80	15.125
	200	5.881	10	6.516	10	16.570
	200	5.915	10	6.414	80	15.688
	200	5.840	300	5.758	10	16.016
	200	5.754	300	5.688	80	15.203

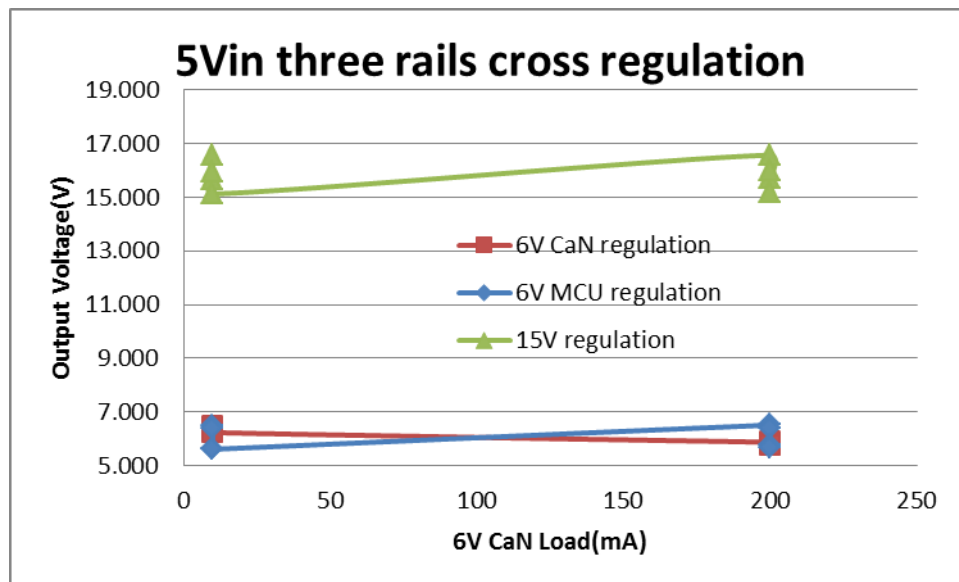

Vin=24V	6V(CaN)(mA)	Vout1	6V(MCU)(mA)	Vout2	15V(Driver)(mA)	Vout3
	10	6.500	10	6.500	10	16.664
	10	6.398	10	6.391	100	15.477
	10	6.351	300	5.570	10	16.000
	10	6.240	300	5.594	100	14.984
	300	5.674	10	6.570	10	16.625
	300	5.781	10	6.391	100	15.492
	300	5.713	300	5.711	10	15.969
	300	5.591	300	5.602	100	14.953

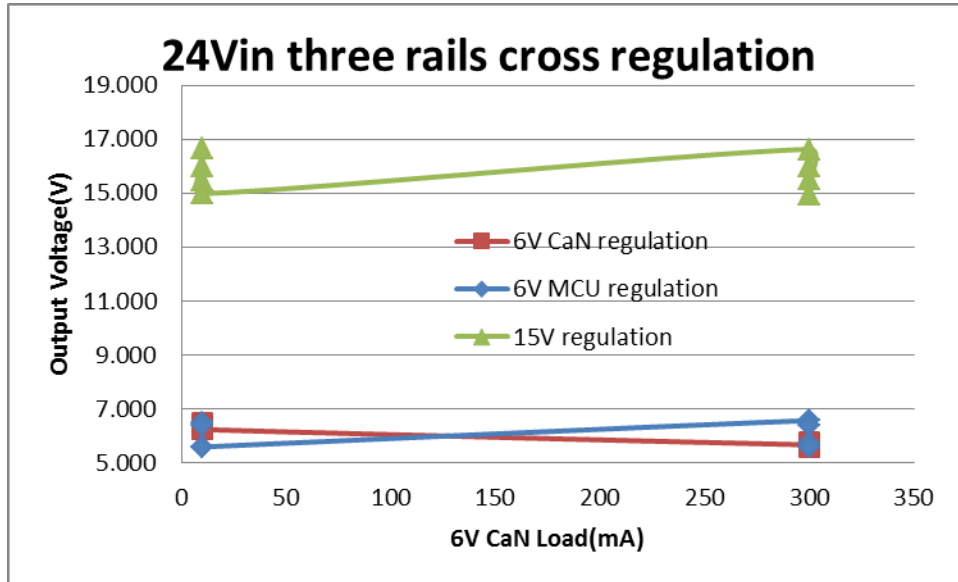

Vin=36V	6V(CaN)(mA)	Vout1	6V(MCU)(mA)	Vout2	15V(Driver)(mA)	Vout3
	10	6.485	10	6.484	10	16.617
	10	6.433	10	6.414	80	15.516
	10	6.346	300	5.414	10	16.031
	10	6.253	300	5.578	80	15.117
	200	5.683	10	6.516	10	16.594
	200	5.8775	10	6.422	80	15.672
	200	5.798	300	5.703	10	16.000
	200	5.733	300	5.656	80	15.188

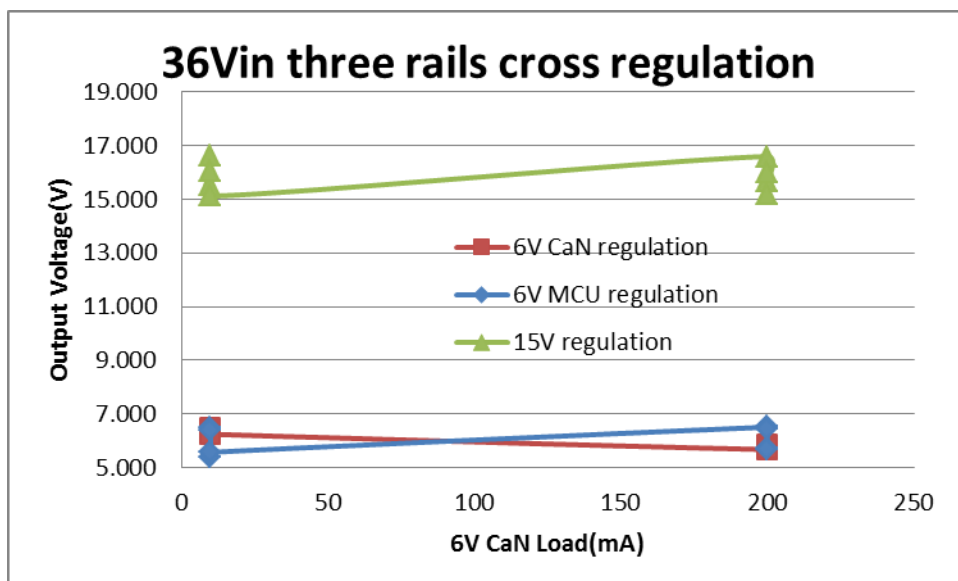

## 2.2 5Vin,24Vin,36Vin no load and full load

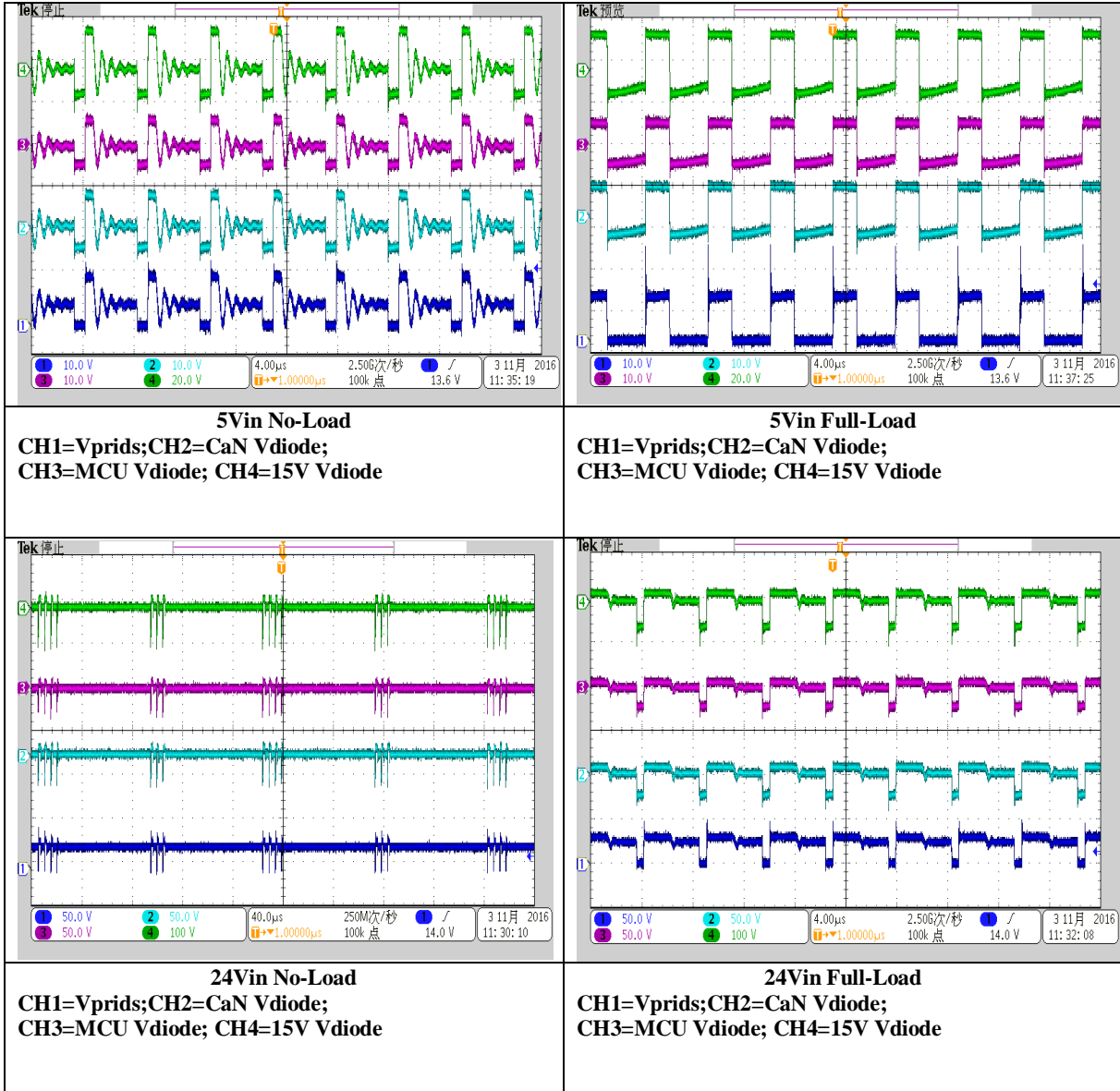

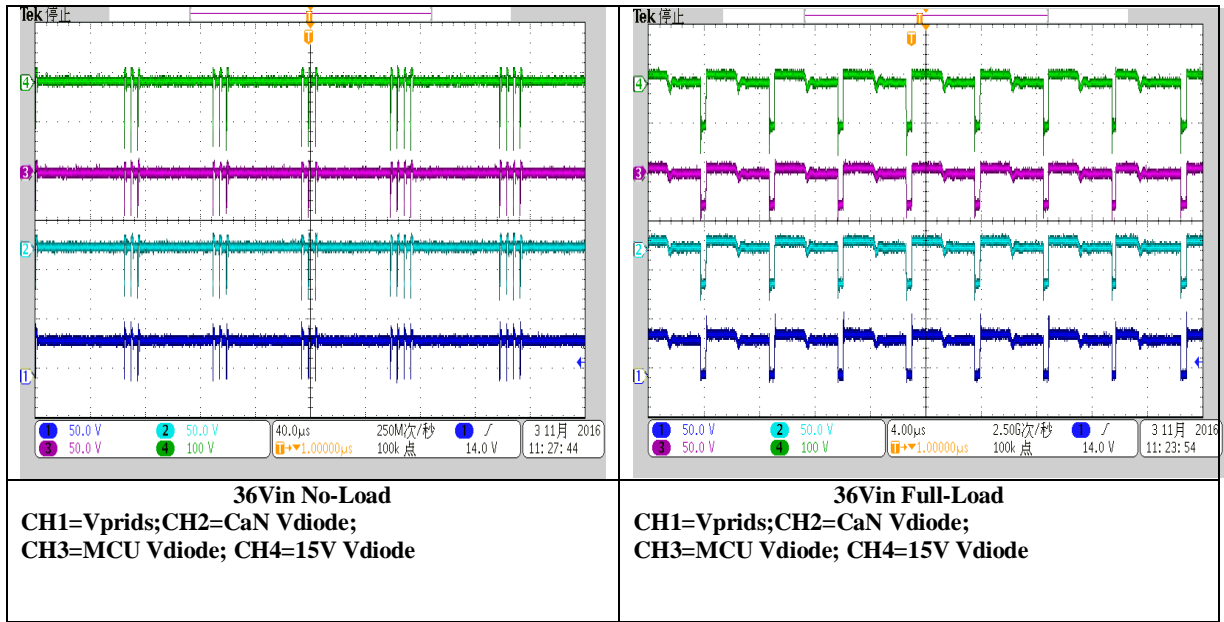

### 2.3 Thermal Performance

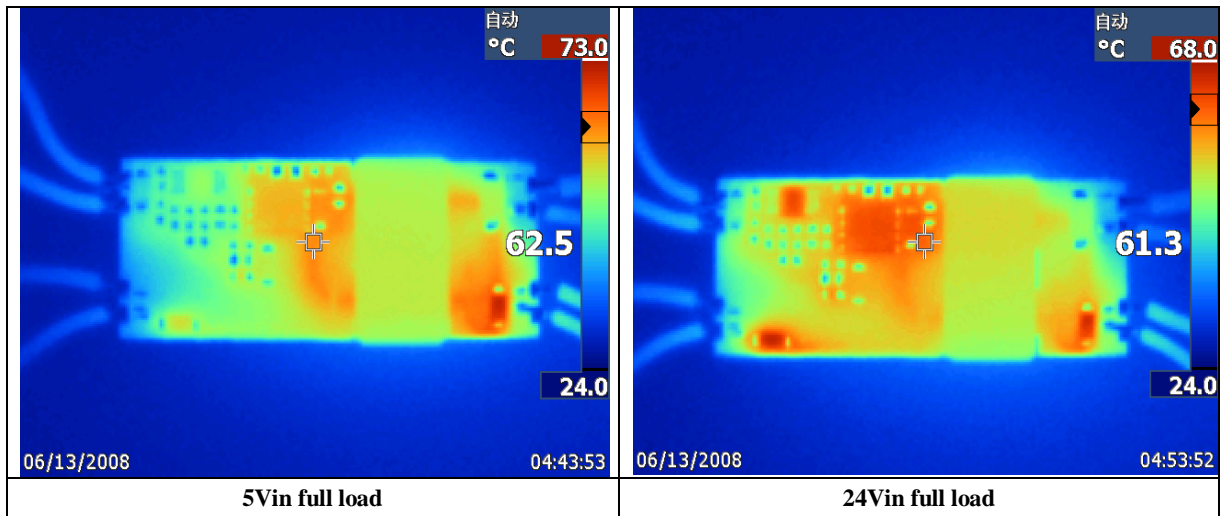

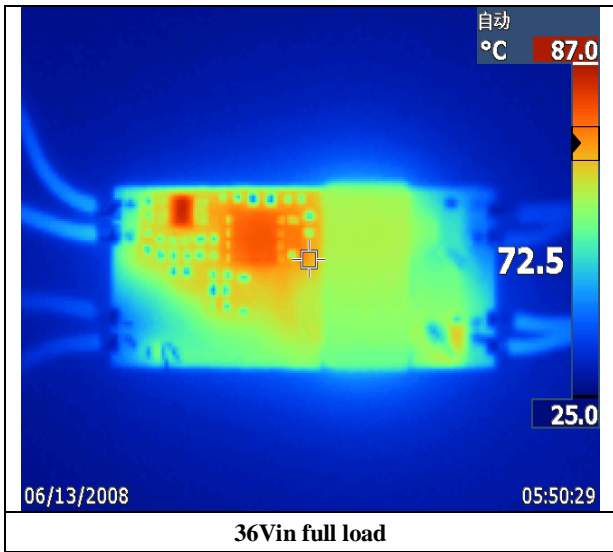

## IMPORTANT NOTICE AND DISCLAIMER

TI PROVIDES TECHNICAL AND RELIABILITY DATA (INCLUDING DATASHEETS), DESIGN RESOURCES (INCLUDING REFERENCE DESIGNS), APPLICATION OR OTHER DESIGN ADVICE, WEB TOOLS, SAFETY INFORMATION, AND OTHER RESOURCES "AS IS" AND WITH ALL FAULTS, AND DISCLAIMS ALL WARRANTIES, EXPRESS AND IMPLIED, INCLUDING WITHOUT LIMITATION ANY IMPLIED WARRANTIES OF MERCHANTABILITY, FITNESS FOR A PARTICULAR PURPOSE OR NON-INFRINGEMENT OF THIRD PARTY INTELLECTUAL PROPERTY RIGHTS.

These resources are intended for skilled developers designing with TI products. You are solely responsible for (1) selecting the appropriate TI products for your application, (2) designing, validating and testing your application, and (3) ensuring your application meets applicable standards, and any other safety, security, or other requirements. These resources are subject to change without notice. TI grants you permission to use these resources only for development of an application that uses the TI products described in the resource. Other reproduction and display of these resources is prohibited. No license is granted to any other TI intellectual property right or to any third party intellectual property right. TI disclaims responsibility for, and you will fully indemnify TI and its representatives against, any claims, damages, costs, losses, and liabilities arising out of your use of these resources.

TI's products are provided subject to TI's Terms of Sale (<https://www.ti.com/legal/termsofsale.html>) or other applicable terms available either on [ti.com](https://www.ti.com) or provided in conjunction with such TI products. TI's provision of these resources does not expand or otherwise alter TI's applicable warranties or warranty disclaimers for TI products.

Mailing Address: Texas Instruments, Post Office Box 655303, Dallas, Texas 75265  
Copyright © 2021, Texas Instruments Incorporated