

How to Choose a Class-D Audio Amplifier

John Satterla and Avi Yashar

ABSTRACT

This white paper covers the attributes of an audio system and focuses on how to digest key specifications to select the best audio amplifier for the application.

Contents

1	Introduction	2
2	Power Consideration	2
3	Power Supply	3
4	Speaker Configuration	3
5	Performance	4
6	Efficiency	6
7	Modulation	7
8	Feedback	8
9	Protection	9
10	Input	10
11	Advanced Features	11
12	Additional Information	11

List of Figures

1	Continuous and Peak Power in an Audio Signal	2
2	Pad-Down vs. Pad-Up Audio Amplifier	2
3	Various Output Configurations	3
4	THD+N vs Output Power in AD Mode for TPA3221	4
5	THD+N vs. Frequency – TAS5805M in PBTL Configuration	5
6	Efficiency vs. 2-Channel Output Power of TPA3221	6
7	Idle Current vs. Supply Voltage for TPA3221	7
8	Open-loop vs. Closed-loop Amplifiers Powered by Battery	9
9	Class-D Amplifier Input Topologies	10

List of Tables

1	THD+N from the TPA3251 Data Sheet	4
---	---	---

Trademarks

PurePath is a trademark of Texas Instruments.
 All other trademarks are the property of their respective owners.

1 Introduction

Audio content has evolved over the years. It's gone from the days of buying 12-inch LP vinyl at the local record store to being able to stream almost any content from the cloud instantaneously. Although some audiophiles are bringing back the days of vinyl as a novelty, the vast majority of audio today is consumed digitally. Even though the way consumers receive audio has changed, one thing has remained constant: a desire to enjoy the content as it was originally recorded. A key component of making this a reality is the audio amplifier in the sound system. With one piece of silicon having such a large impact on the audio quality, it's important to understand the tradeoffs and how to choose the right one for a design.

2 Power Consideration

An end product's features are usually defined before it is designed — an example being the target loudness for a voice-controlled smart speaker that should be audible across the room. In terms of electrical system design, the loudness correlates with output power and speaker/voice coil efficiency. Without knowing a lot of details about the end system, output power is the closest specification one could use to determine the loudness (usually approximated in dB) of the finished product. Hence, the output power level is usually one of the first criteria used to select an audio amplifier. The industry standard for specifying the power level of an amplifier is the output power at 1% or 10% total harmonic distortion plus noise (THD+N). Typically, the number of channels at that power level is also referenced, so a stereo device could be specified as 2 x 100 W at 10% THD+N. One important thing to note when referring to an amplifier's power level is whether it is specified as a peak or continuous value.

Class-D amplifiers are usually up to about 90% efficient and the approximate 10% loss of energy is converted to heat. To protect the integrated circuit, Class-D audio amplifiers have a temperature threshold at which they shut down. So a device may be able to hit a certain peak output power level, say 30 W, but not be able to sustain this level for an extended period of time without going into over-temperature shutdown. The highest output power level a system could support and sustain without reaching the over-temperature state is considered to be the maximum continuous output power level.

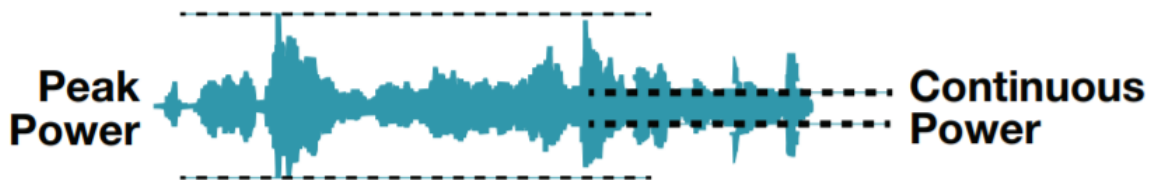

Figure 1. Continuous and Peak Power in an Audio Signal

Since the continuous output power level relies on heat dissipation, it depends on factors of the end system; for example: PCB thickness, enclosure size, and ventilation. A major attribute that does impact the continuous output power level from the amplifier is the thermal pad orientation. Devices with a thermal pad on the bottom are soldered directly to a PCB, while devices with the thermal pad on the top require a heatsink. Using a heatsink can increase the continuous output power level, but may in turn require extra space and heatsink material.



Figure 2. Pad-Down vs. Pad-Up Audio Amplifier

3 Power Supply

An important piece of the output power equation is the supply voltage for the amplifier. Some Class-D amplifiers use one rail and others (bipolar or split-rail amplifiers) use two of equal magnitude, but opposite polarity rails to amplify the audio signal. Aside from this, another rail is typically required for internal logic regulators and gate-drive circuitry, such as 1.8 V, 3.3 V, 5 V, or 12 V. Some newer devices like the [TPA322x](#) family integrate a linear drop-off regulator (LDO) internally to produce this rail from the main supply rail. While using the internal LDO isn't as efficient, it can provide large cost and design savings if the necessary supply voltage isn't already available in the system. A great use case for single-rail supply amplifiers with an LDO are battery-operated speakers. For systems with a very low supply voltage, from a 1S battery for example, often a boost converter is used to drive the necessary output power. Class-D amplifiers such as [TAS2562](#) even integrate a boost converter for overall system cost and space savings.

4 Speaker Configuration

A speaker's output power is correlated to the power supply and the load connected to the audio amplifier. The amplifier itself also limits the output power for an audio system, as the core of an audio amplifier is a MOSFET amplifying the analog signal, restricted by voltage, current, and thermal limits. Ohm's law dictates that current is a function of voltage and resistance, making power inversely proportional to resistance (the load). Since an amplifier has limitations on its voltage and current, the resistance of the speaker is important to consider when selecting an amplifier. Drivers typically range between 2-8 Ω . A lower impedance driver draws more current and produces higher output power for as long as the amplifier is able to support it. Lower impedances are typically used in subwoofers (2-4 Ω) while higher impedances (4-8 Ω) are used for woofers and tweeters.

Generally, a Class-D amplifier can be manipulated to provide different levels of power by topology. For example, a Class-D amplifier with four half-bridges can drive 4, 2 or even just 1 channel. These topologies are referred to as single-ended (SE), bridge-tied load (BTL), and parallel bridge-tied load (PBTL). Bridging two outputs effectively doubles the voltage across the load, while configuring them in parallel allows double the current. In theory, doubling the voltage and current in mode PBTL should quadruple the power, but since amplifiers have voltage and current limitations, running in PBTL typically only allows for more power into smaller loads. These output configurations can be seen in [Figure 3](#). For more information on output configurations, visit section one of the [LC Filter Design](#) application note.

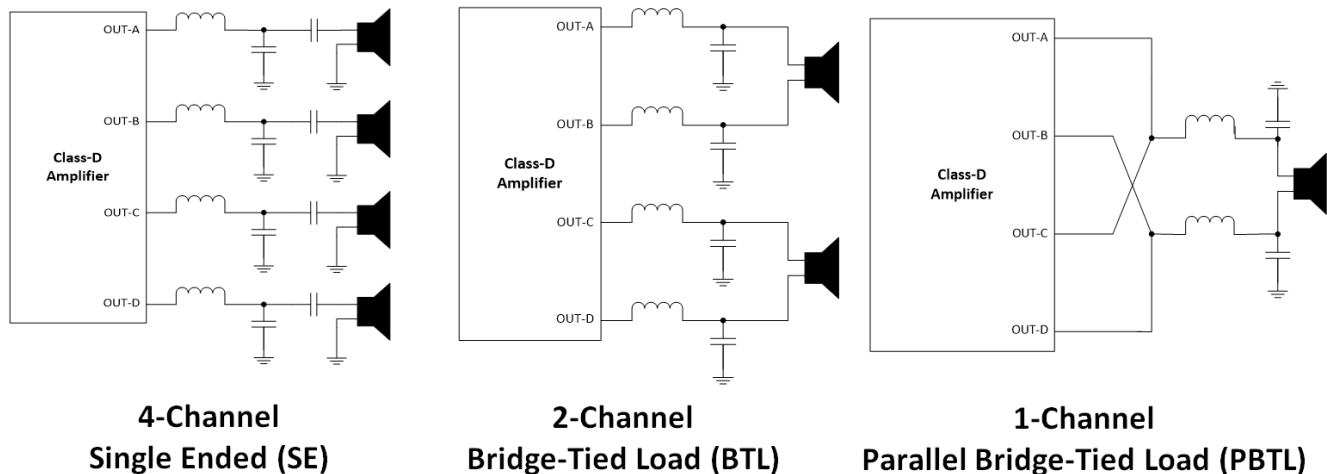

Figure 3. Various Output Configurations

5 Performance

The overall quality of sound from a system depends on the “weakest link.” This includes everything from the quality of the drivers to the sample rate of a digital-to-analog converter (DAC). In evaluating an amplifier’s performance, one of the first major specifications to understand is THD+N. This references how much harmonic distortion, or overtones, as well as noise is added to the audio signal after amplification. In other words, this can measure how “true” the amplified signal is to the original, and the lower the THD+N, the better. Since THD+N varies with output power level and frequency, a common way to cite the THD+N of a device without a graph is to use a specific output power level and load at 1kHz. For example, 0.02% THD+N at 1 W into 4 Ω using a 1 kHz signal. See an example from the [TPA3251](#) data sheet in [Table 1](#).

Table 1. THD+N from the TPA3251 Data Sheet

THD+N _{SPK}	Total harmonic distortion and noise ($P_0 = 1\text{ W}$, $f = 1\text{ KHz}$, $R_{SPK} = 6\ \Omega$)	$V_{PVD D} = 12\text{ V}$, $SPK_GAIN = 20.9\text{ Vp}$, LC-filter	0.03%
		$V_{PVD D} = 24\text{ V}$, $SPK_GAIN = 29.5\text{ Vp}$, LC-filter	0.03%

However, the THD+N of a device is best conveyed through a graph. See [Figure 4](#) for an example of a THD+N curve.

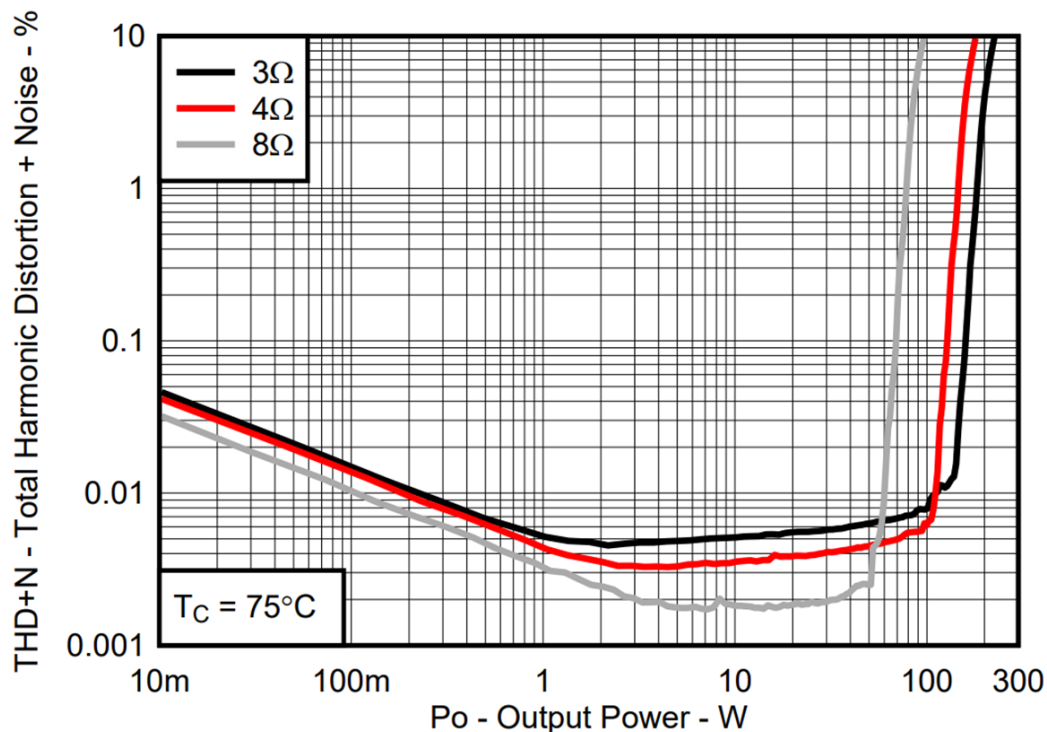
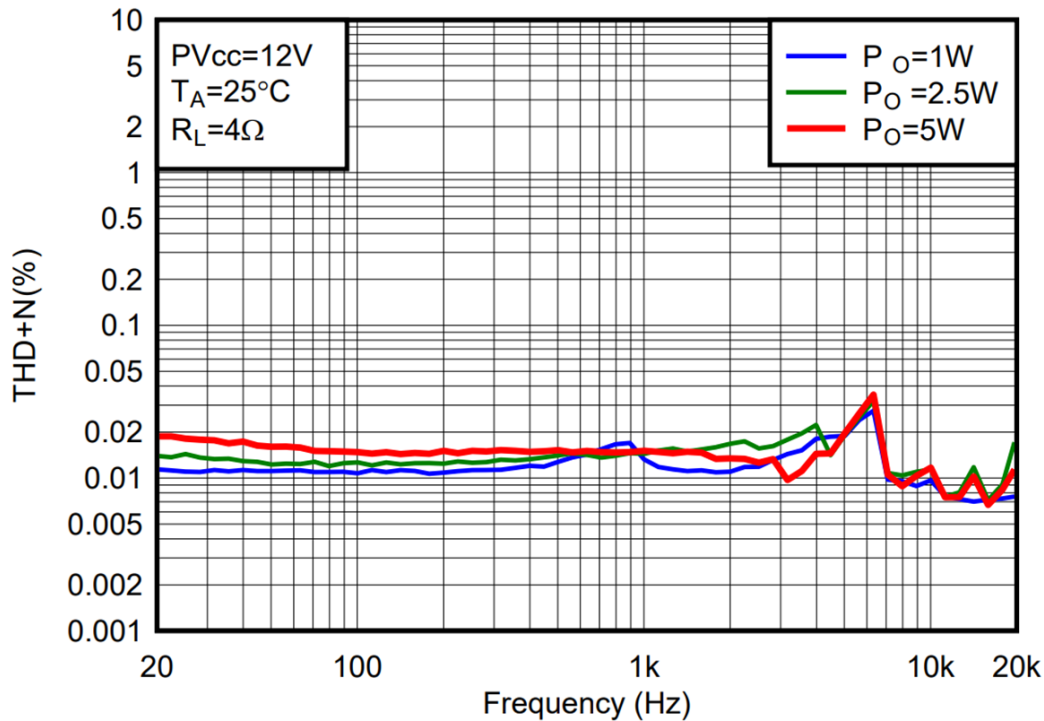

Figure 4. THD+N vs Output Power in AD Mode for TPA3221

The next important specification to consider is the signal bandwidth and frequency response of an amplifier. The bandwidth refers to the range of frequencies it can support. Standard Class-D amplifiers support 20 Hz to 20 kHz; however, high-performance amplifiers can support much higher for content from high definition (HD) sources. As ultrasound frequencies (greater than 20 kHz and inaudible to humans) are adapted into smartphones and smart speakers for hand gesture recognition and presence detection, higher bandwidth is becoming increasingly important. While the bandwidth refers to the range of frequencies supported, the frequency response indicates how well the amplifier performs throughout its bandwidth. This can be shown in various ways, such as frequency against the sound-pressure level (SPL) of an end system or frequency against THD+N. [Figure 5](#) shows the frequency response of [TAS5805M](#) in PBTl using 12 V into 4 Ω.



PVDD = 12V 4.7uH + 0.68uF
 $F_{SW} = 576$ kHz 1SPW Modulation Load = 4Ω

Figure 5. THD+N vs. Frequency – TAS5805M in PBTL Configuration

The bandwidth should not be confused with the sampling rate or the modulation frequency, which is also measured in kHz. If an amplifier references a sampling rate, this is because it includes a DAC and sometimes a digital signal processor (DSP). While an analog signal is continuous, a digital signal is made up of thousands of samples of the signal per second. The resolution of samples per second is what's referred to as the sampling rate or sampling frequency. In a digital amplifier, the bandwidth is limited by the sampling frequency. According to Nyquist's theorem, also referred to as sampling theorem, the sampling frequency must be at least twice the desired bandwidth. Therefore, a system intending to play 40 kHz ultrasonic tones would need a sampling rate greater than or equal to 80 kHz, making an amplifier with 96 kHz sampling rate suitable.

The modulation frequency or switching frequency refers to how fast the pulse-width modulator of the Class-D amplifier switches, modulating the analog signal. Technically, this could affect the resolution of the audio signal, but for typical audio applications it's always well above the sampling rate. The switching frequency is usually between 200 kHz to 1.5 M, or even as high as 2.1 MHz as seen in some industry leading automotive Class-D amplifiers, like [TPA6304-Q1](#). While the switching frequency doesn't usually impact the signal bandwidth, it does still play a role in electromagnetic interference (EMI) since the pulses emit high frequency energy. Modulation schemes and EMI will be addressed in more detail in a later section.

A few more common performance parameters include signal-to-noise ratio (SNR), dynamic range (DNR), and power supply rejection ratio (PSSR), all of which are measured in dB. The SNR conveys information similar to the THD+N: how true the reproduced amplified signal is to the intended audio signal. While the THD+N also reflects distortion, the SNR strictly measures the ratio between the average signal level and the average noise level, so the higher the better. The dynamic range is then the ratio between the lowest possible level of noise (noise floor) and the loudest possible undistorted signal, effectively the best

possible SNR of the system in ideal circumstances. The power supply rejection ratio also speaks to noise, but in a different way. It refers to the ratio between how much a change at the input results in a change at the output. Basically, it quantifies how much the amplifier “rejects” noise at the input. If the ratio is really low, the amplifier is taking the noise and amplifying it to the output. If it is high, less of the noise is amplified to the output. Thus, a higher number here is once again better.

6 Efficiency

Class-D amplifiers provide a significant improvement in efficiency compared to traditional linear amplifiers. Common reasons for seeking high efficiency in an audio amplifier include seeking longer runtimes from battery-powered speakers, managing heat in space-constrained applications such as mini-smart speakers or set-top boxes (STBs), or even passing government regulations on stand-by current in always-on devices. Higher efficiency means lower energy waste, where the waste of a Class-D amplifier is in the form of heat and electromagnetic field (EMF) emissions. The more wasteful the device is, the more the system needs to accommodate that waste. For thermal accommodations, this could mean a PCB with thicker copper layers, a heatsink and thermal paste, or sometimes even a fan with ventilation, all of which can contribute to overall system cost.

While it is easy to tout “greater than 90% efficiency,” this number refers to the power efficiency of the amplifier at a specific load and output power, which may not reflect the typical use case. The efficiency of an amplifier is best shown by a graph, for example the efficiency of **TPA3221** in **Figure 6**. Since Class-D amplifiers burn a base amount of power just by operating, they’re most inefficient at their lowest output power levels and most efficient at their highest output levels.

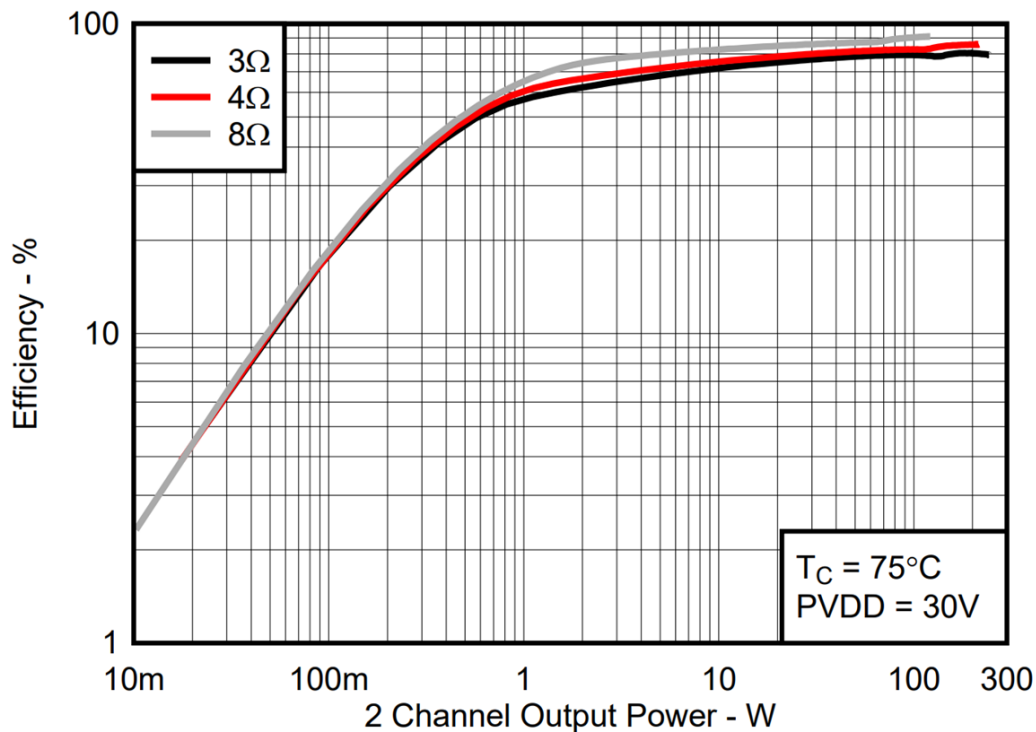

Figure 6. Efficiency vs. 2-Channel Output Power of TPA3221

A key concern in the audio industry for efficiency is idle power loss. This refers to how much power is consumed by the audio amplifier when there is no audio playing, but the device is ready to play at any moment. This is especially important for battery-powered applications, since the battery still drains when the device is on even while the user is not actively playing audio. Sometimes the idle power consumption is specified explicitly in a datasheet for different configurations, and sometimes it has to be calculated from

other values. Power is the product of voltage and current, so the total idle power consumption can be calculated by multiplying the corresponding voltages and idle currents in the amplifier and adding them together. In cases when there is an LDO or boost converter, the calculation can become more complicated since there are additional losses to be accounted for in the entire audio system. See [Figure 7](#) for an example of an idle current graph for different modulation schemes on the TPA3221.

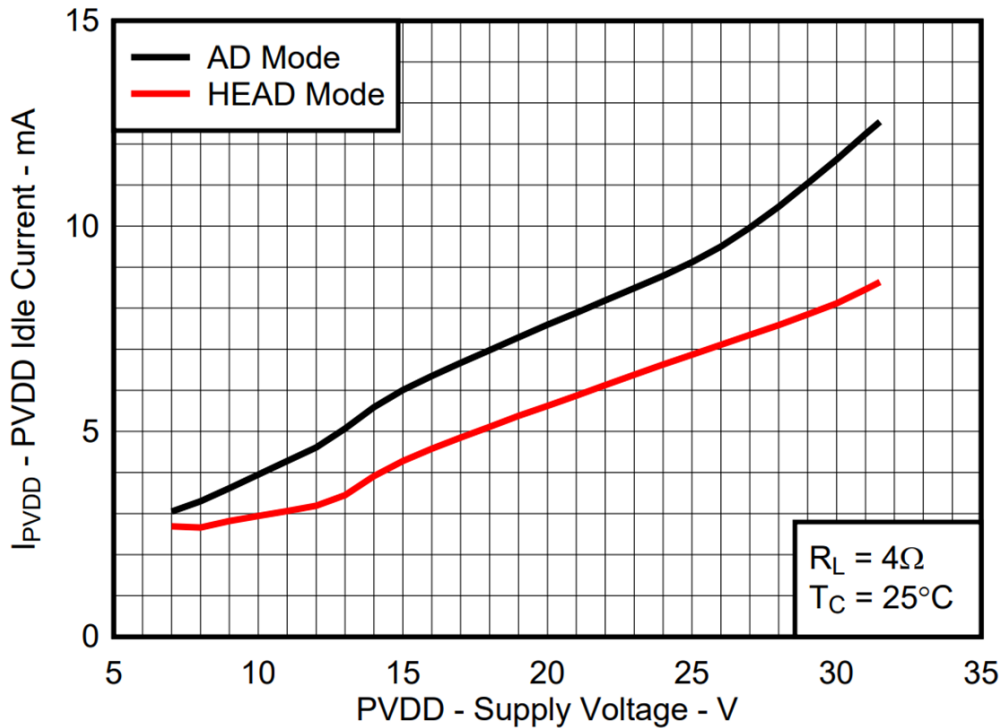

Figure 7. Idle Current vs. Supply Voltage for TPA3221

The $R_{DS(ON)}$, which is the resistance between the drain and source terminals of the internal MOSFETs in the amplifier, effectively relates to the amount of power that is consumed when biasing the MOSFET on. Therefore, a lower $R_{DS(ON)}$ results in lower idle current, making this value frequently sought out by engineers to quickly compare amplifiers for idle efficiency.

While efficiency is critical to battery powered speakers for runtime, it's also important to all systems for thermal and electromagnetic interference (EMI) reasons. Due to the conservation of energy, all of the "wasted" power converts to other forms of energy. In audio amplifiers, it manifests as heat and EMF. Heat is a primary concern because all the components inside a device have thermal operating limits. If a device gets too hot it could damage the device, but since most devices have thermal protection they usually shut off. Some devices have protection features to dial back power near high temperature thresholds such as [thermal foldback](#) to keep the device running as long as possible, and others just shut down when those thresholds are exceeded. Again, the higher the efficiency, the less demanding the amplifier will be thermally.

7 Modulation

Modulation is at the heart of Class-D amplifiers as opposed to Class-A, AB, and B amplifiers, which are linear and do not use modulation. Instead of amplifying the audio signal directly, a Class-D amplifier first uses the continuous analog audio input and creates a PWM signal. The PWM signal is then amplified by the output stage and an external LC filter is used to remove the high frequency modulation and leave behind the amplified audio signal. Class-D amplifiers are generally far more efficient than their counterparts, but amongst them there are several modulation schemes to consider. A modulation scheme refers to the method at which the continuous analog audio signal is converted into a PWM signal. A few modulation schemes include AD, BD, 1SPW, HEAD, and hybrid. The different schemes offer different benefits, such as higher performance or greater efficiency. While AD and BD use a 50% common duty

cycle between the bridge-tied outputs, 1SPW uses a lower common duty cycle closer to 15-20%. This reduces the DC offset from half the supply voltage to about one-fifth of the supply voltage. Lower DC offset reduces the ripple current through the LC filter and the amplifier's supply (PVDD) current, which mitigates "pop" noise at startup, reduces EMI, and most importantly minimizes power losses especially at idle. The downside to 1SPW is that at high output, one output channel is effectively acting as a ground, so the BTL system resorts to single sided switching, making it almost like a single-ended (SE) system. SE audio performance is inferior to BTL, so there is a trade-off for the added efficiency. In the hybrid and HEAD modulation schemes, some processing is done to dynamically change the common duty cycle based on the audio output. In this way, a low DC offset is maintained for the idle state, but increased for higher output levels to avoid single-sided switching. These proprietary TI modulation schemes offer the best of both worlds, improving efficiency without sacrificing audio quality. Refer to section 2 of the [LC Filter Design](#) application note to understand more about AD and BD modulation. Refer to section 5 of the [TAS5805 Hybrid Mode](#) application note or the [HEAD Modulation](#) application brief to learn how Hybrid or HEAD modulation schemes can improve efficiency, and even EMI or click/pop-noises.

Regarding the modulation of a Class-D audio amplifier, there are other things to consider aside from just the scheme. The same modulation scheme can be implemented at different modulation or switching frequencies. As previously mentioned, the switching frequency is usually between 200 kHz to 1.5 MHz, or even as high as 2.1 MHz as seen in some of the industry leading automotive Class-D amplifiers such as the [TAS6424-Q1](#). The modulation frequency impacts distortion, the EMI of a device, the demand on the LC filter and more. The modulation of a Class-D amplifier leaves artifacts in the audio signal at harmonics of the modulation frequency. Having a higher frequency eliminates some of the potential distortion from harmonics. The high frequency waves also propagate EMF, resulting in interference depending on the application. For example, some Class-D amplifiers pose a problem for radios in Europe, where digital audio broadcasting (DAB) is used broadly. The speaker amplifier in an application with DAB radios must pass more stringent EMI tests than otherwise, and choosing a modulation scheme and frequency accordingly is important. A similar problem exists with the AM frequency band, which is why some devices have an AM avoidance feature to manipulate the switching frequency in order to dodge the AM bands. However, using 2.1 MHz switching completely avoids the AM frequency band (540–1,600 kHz), which is especially useful in automotive head units, where traditionally a heavy-duty metal casing would be necessary to prevent emissions from the amplifier causing interference with the radio signal. Some Class-D devices offer a range of modulation frequencies to implement the device with, so it can be selected on a system-by-system basis.

Regardless of the modulation scheme, after the signal is amplified it needs to be converted from PWM back to a continuous audio signal to play through the speakers. To do this, an LC filter is used at the output of a Class-D amplifier. Depending on the modulation scheme, frequency, and power level, sometimes full LC filters are unnecessary. For output power levels below 10 W, some of TI's new amplifiers have advanced features such as [spread spectrum and de-phase control](#), which reduces the demand for an LC filter to the point where tiny ferrite beads can be used to filter PWM signal. Such a capability is incredibly valuable for saving cost on the overall BOM since ferrite beads are cheaper than inductors.

8 Feedback

Class-D amplifiers vary in their feedback topology. Some devices have an internal integrated closed-loop feedback circuit, some have open-loop, and some are configured to support an external closed-loop feedback circuit. Feedback affects the audio performance and noise of a device. Generally, closed-loop systems outperform open-loop systems. Aside from this, a closed-loop device can provide a more consistent output power even with a varying supply voltage. An open-loop device would decrease its output in case of a battery-powered supply, or vary with unstable power supply. The best example of this is an old-school flashlight, where the light dims overtime as the batteries get weaker. As shown in [Figure 8](#) are the results of an experiment where a battery-powered *Bluetooth*® speaker using TAS5342A was re-wired to use the TPA3221 instead. The test was conducted multiple times using each device with the same results. Beginning with a fully charged battery, pink noise was played and the sound pressure level (SPL) was measured until the speaker stopped playing due to the battery draining. While both devices had a similar average SPL, the closed-loop TPA3221 maintained a constant SPL through shutdown while the open-loop TAS5342A demonstrated a decay correlating with the draining battery voltage.

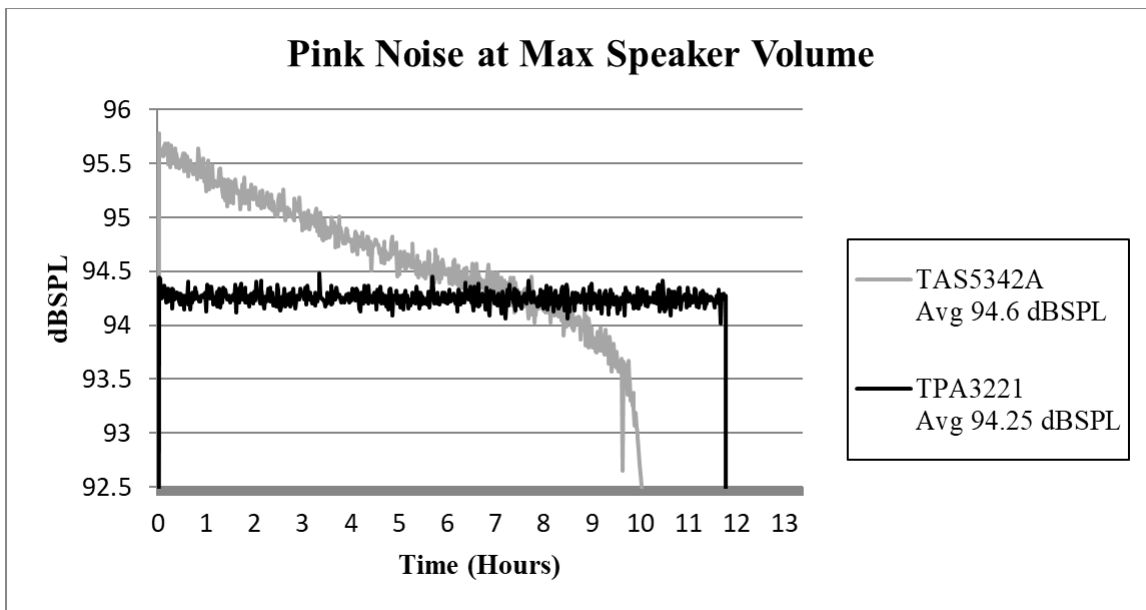

Figure 8. Open-loop vs. Closed-loop Amplifiers Powered by Battery

Some devices support further enhancement through the use of a feedback loop created external to the amplifier, in addition to their internal feedback loops. This is referred to as a post-filter feedback loop. For more information on this, visit the [TPA324x and TPA325x Post-Filter Feedback](#) application note.

9 Protection

Protection features in Class-D audio amplifiers cover everything from electricity to heat. A standard protection feature is over-temperature shutdown, in which the amplifier turns off if the temperature rises beyond a set threshold. At too high of a temperature, the IC could sustain permanent damage or even present a safety hazard if it combusts. Heat is a common point of contention in audio systems, since even the best Class-D amplifiers are only around 90% efficient. This means roughly 10% of the power dissipates into the system as EMI and heat. Put this in a confined space and the problem is obvious, especially for applications like portable wireless speakers which may be exposed to the sun. Advanced thermal management systems like thermal foldback automatically dial back the gain over time as the temperature increases, allowing the device to cool off. Instead of overheating and shutting off, the volume is decreased to continue playing.

Along the same lines, some devices implement cycle-by-cycle current control (CB3C) as opposed to latching-shutdown. Latching-shutdown performs an immediate shut down of output in the case of excess output current. Usually devices featuring CB3C offer both options. Since CB3C limits the output current for each switching cycle, it prevents premature shutdown due to temporarily high output current. This may be caused by high level music transients and a drop of the real speaker's load impedance. To understand CB3C in more detail, visit section 9.4.1.1 of the [TPA3244 datasheet](#), which explains this feature in depth.

Under-voltage and over-voltage protection are two other common protection features that protect the device in the case of surges, brownouts, or even power-up/down. A less self-explanatory protection feature is DC speaker protection. This feature is not as common, but effectively a DC protection scheme prevents a speaker from excess DC current in case one speaker terminal is accidentally shorted to the chassis ground while the other is connected to the amplifier. This could occur if the end user assumes that the negative speaker output terminal is the same as ground. In BTL configuration, this terminal-to-ground short would result in a DC voltage of $PVDD/2$ across the speaker, which could destroy the speaker. DC speaker protection detects any imbalance between the two outputs of a bridge-tied load and shuts down in

the event of an imbalance exceeding a programmed threshold. Speaking of shorts, yet another important feature that protects the devices from permanent damage is pin-to-pin short circuit protection (PPSC). PPSC checks that there are no shorts at the output pins of the amplifier during startup. These protection features are not only useful, but can even save PCB space and BOM cost since they are integrated into the amplifier as opposed to external protection circuitry.

10 Input

As mentioned in the modulation section, PWM is fundamental to a Class-D amplifier. However, some amplifiers do not include a modulator and instead receive an already-modulated audio signal as input, making them PWM-input Class-D amplifiers. Often these amplifiers are referred to as digital-input amplifiers, because they are to be paired with modulators that have an integrated DAC. Alternatively, some amplifiers integrate a DAC and PWM internally to take direct digital-input. Of course, between these two are analog-input amplifiers which integrate the PWM but not a DAC. See Figure 9 to understand the different input types of Class-D audio amplifiers.

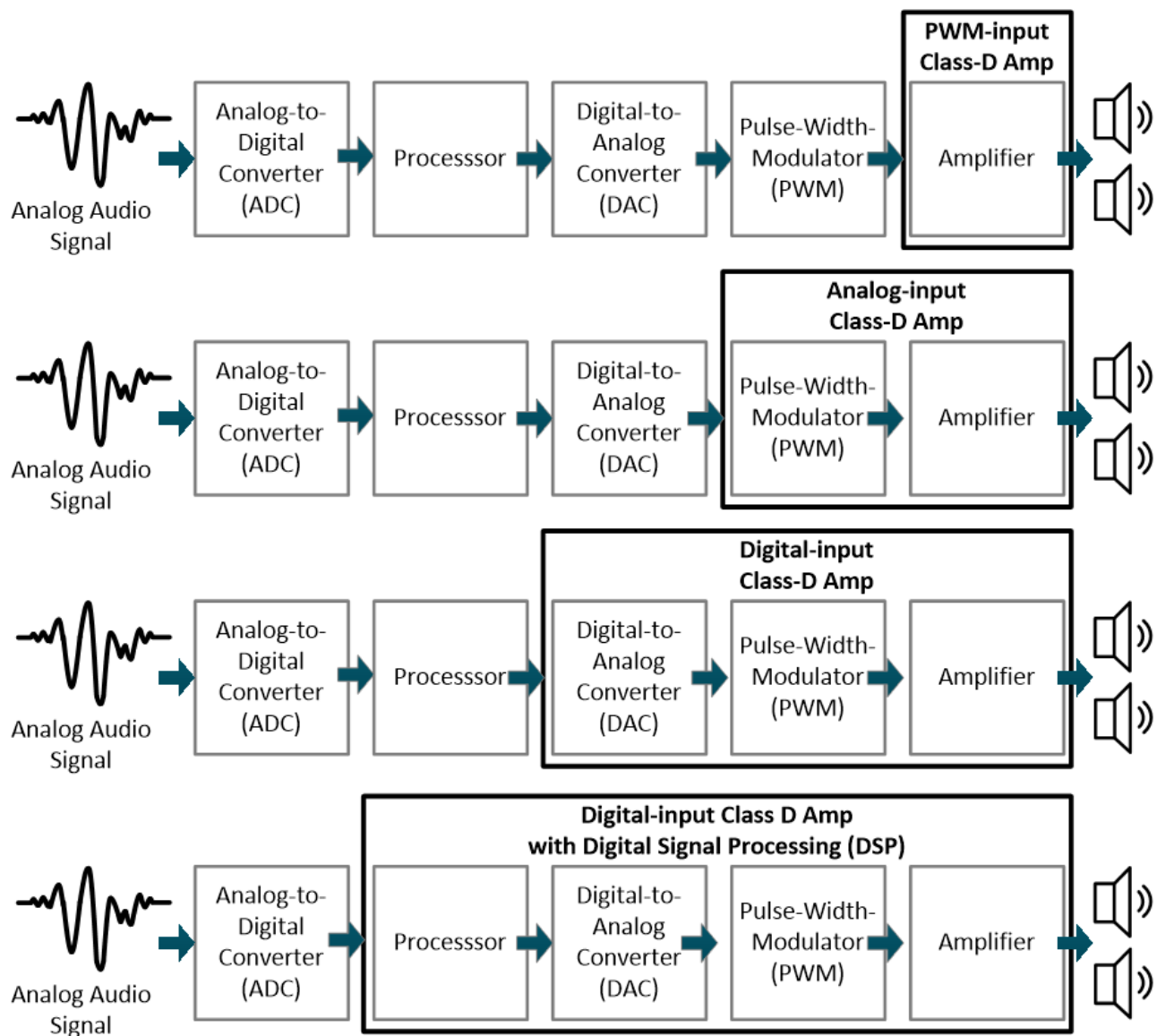

Figure 9. Class-D Amplifier Input Topologies

Digital-input formats vary, but the most common are inter-IC-sound (I2S), time division multiplexing (TDM), pulse-density modulation (PDM) and SoundWire. The most common amongst those is I2S, which has universal standards unlike other formats such as TDM, which can vary. The different formats handle data transfer and data clocking differently, making some better for systems with multiple sources, for example.

Analog-input devices are a bit simpler, but still have options. Analog-input can be in the form of single-ended or differential signals. Differential input uses two pins for the high (+) and low (-) of the signal. The differential signal is then the difference between the two inputs, thus canceling out any common voltage on the two pins. This effectively reduces any EMI or noise imposed on both signals. Single-ended input on the other hand has just one input pin and then a common pin, making it more susceptible to passing EMI and noise to the amplification stage.

11 Advanced Features

From design simplicity to enhanced audio, advanced features can mean hardware or software related improvements. Analog-input power stages often require smaller circuits before the audio amplifier referred to as the pre-amp stage. Some device families such as the [TPA322x](#) offer selectable gains to simplify pre-amplifier circuitry. As mentioned before, almost all Class-D amplifiers require at least two supply-voltages to operate: the main supply voltage for amplifying the audio and a secondary rail for gates/logic. For systems that don't already have an available secondary supply rail, adding one can be inconvenient and of course costly. A hardware feature addressing this is an integrated LDO to allow for single-supply operation, which the TPA322x family supports as well.

Digital-input devices with a DSP can offer even more advanced features. The integrated DSP can be used for equalization (EQ), dynamic range compression (DRC), automatic gain limiting (AGL), or even Class-H supply voltage envelope tracking. Perhaps one of the most impressive advanced features TI offers is PurePath™ Smart Amp technology. Using a [PurePath Learning Board](#) and a compatible smart amp such as TAS5825M, speakers can be characterized and tuned to increase loudness and improve frequency response without damaging a speaker. This [A/B comparison experiment video](#) shows the potential for improvement in a small voice recognition smart speaker. To learn more about advanced features in amplifiers, reference the [TAS5825M Advanced Features](#) application note.

12 Additional Information

Additional information regarding the topics discussed in this paper can be referenced in the following documents.

[LC Filter Design](#) application report

[HEAD Modulation](#) application brief

[Hybrid Modulation with TAS5805M](#) application report

[Post-Filter Feedback](#) application report

[TAS5825M Advanced Features](#) application report

[TAS5825M Process Flows](#) application report

[General Tuning Guide for TAS58xx Family](#) application report

IMPORTANT NOTICE AND DISCLAIMER

TI PROVIDES TECHNICAL AND RELIABILITY DATA (INCLUDING DATASHEETS), DESIGN RESOURCES (INCLUDING REFERENCE DESIGNS), APPLICATION OR OTHER DESIGN ADVICE, WEB TOOLS, SAFETY INFORMATION, AND OTHER RESOURCES "AS IS" AND WITH ALL FAULTS, AND DISCLAIMS ALL WARRANTIES, EXPRESS AND IMPLIED, INCLUDING WITHOUT LIMITATION ANY IMPLIED WARRANTIES OF MERCHANTABILITY, FITNESS FOR A PARTICULAR PURPOSE OR NON-INFRINGEMENT OF THIRD PARTY INTELLECTUAL PROPERTY RIGHTS.

These resources are intended for skilled developers designing with TI products. You are solely responsible for (1) selecting the appropriate TI products for your application, (2) designing, validating and testing your application, and (3) ensuring your application meets applicable standards, and any other safety, security, or other requirements. These resources are subject to change without notice. TI grants you permission to use these resources only for development of an application that uses the TI products described in the resource. Other reproduction and display of these resources is prohibited. No license is granted to any other TI intellectual property right or to any third party intellectual property right. TI disclaims responsibility for, and you will fully indemnify TI and its representatives against, any claims, damages, costs, losses, and liabilities arising out of your use of these resources.

TI's products are provided subject to TI's Terms of Sale (www.ti.com/legal/termsofsale.html) or other applicable terms available either on ti.com or provided in conjunction with such TI products. TI's provision of these resources does not expand or otherwise alter TI's applicable warranties or warranty disclaimers for TI products.

Mailing Address: Texas Instruments, Post Office Box 655303, Dallas, Texas 75265
Copyright © 2020, Texas Instruments Incorporated