



Sudhir Nagaraj

ABSTRACT

An intelligent decay scheme continuously adapts to provide the best possible decay solution

To handle re-circulation current in a current-chopping stepper motor drive, traditional decay schemes such as fast decay, slow decay and fixed-mixed decay fall short of optimal micro-stepping current regulation. End users often compromise certain micro-stepping performance parameters in order to achieve others. What if there was no compromise?

This white paper introduces an intelligent decay scheme that continuously adapts to provide the best possible decay solution according to demands. This feature can now be integrated into a motor driver integrated circuit (IC) eliminating the need for the end user to tune the motor.

Table of Contents

1 Trademarks.....	1
2 Stepper motor: A brief overview.....	2
3 What is decay?.....	3
4 Problem statement.....	5
5 Problem solution.....	6
6 Advantages.....	7
7 Conclusion.....	11
8 References.....	12

1 Trademarks

All trademarks are the property of their respective owners.

2 Stepper motor: A brief overview

Stepper motors are ubiquitous. They are used in a wide range of applications from robots, printers, industrial position control, projectors, cameras and so many more.

A stepper motor typically has two electrical windings. An H-bridge is used to drive each winding. Motor position is controlled by regulating the current in motor windings. For a smooth motor motion profile and finer position control, micro-stepping is desired. While micro-stepping, the current in these windings is regulated in a sine (red) and cosine (blue) function (see [Figure 2-1](#)). Each step corresponds to a preset current level. Having a non-optimal decay scheme does not allow for good micro-stepping, which translates to poor motor position control.

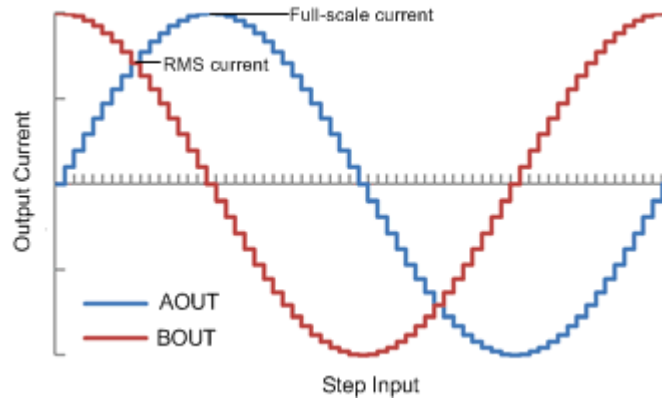

Figure 2-1. Sine and cosine functions of micro-stepping

3 What is decay?

Decay is defined as re-circulation current in the drive switches and diodes once the drive is interrupted, which is common in a pulse-width modulation (PWM) current regulation/chopping technique. The drive current typically is interrupted once the chopping current threshold is achieved. To handle this decay current, the H-bridge can operate in two different states: fast decay and slow decay. Mixed decay, a combination of fast and slow decay, is also employed. These states are shown in Figure 3-1 for a positive current flow.

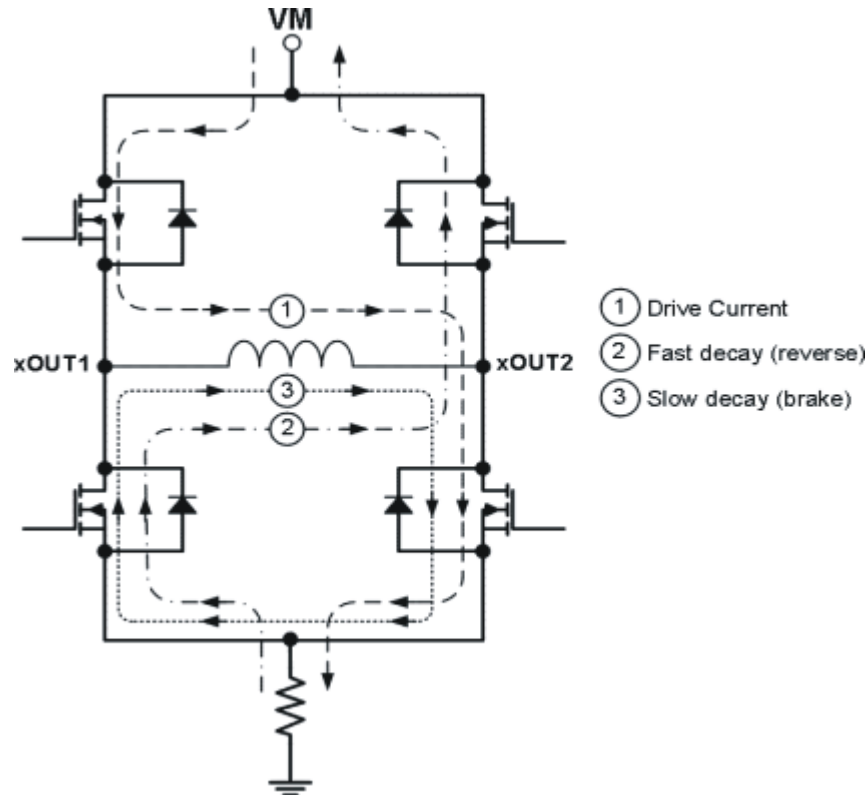

Figure 3-1. Sine and cosine functions of micro-stepping

A typical PWM cycle and sequence of events in time is depicted in Figure 3-2. The various decay modes from this figure are described below.

In slow decay, current is re-circulated using both low-side FETs. However, the slow rate of current decrease during winding limits some current levels being regulated.

In fast decay, the H-bridge reverses the voltage across the winding. This decreases the current at a much faster rate. The limitation with fast decay is that the current charge and discharge rates are similar; thus, the ripple current can be huge. This leads to inefficiency and limits some current levels that can be regulated.

Mixed decay is a combination of slow and fast decay. It begins with fast decay and after a fixed time, switches to slow decay mode. Fixed-mixed decay also has its limitations. A percentage of PWM cycle or a combination of slow and fast decay needs to be optimized for a given motor, stepping rate, magnitude of load current and supply voltage. Lower load current levels typically need a different percentage mix compared to higher current levels.

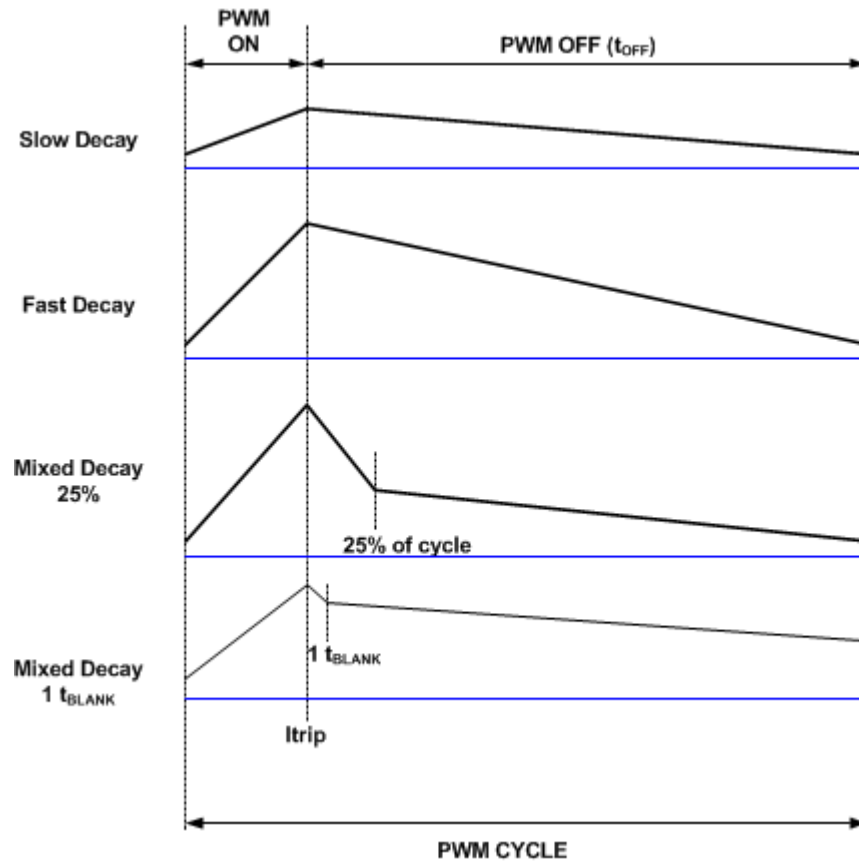

Figure 3-2. Current waveforms in slow, fast and mixed decay modes

4 Problem statement

There are several limitations of conventional fixed-decay schemes (slow, fast and mixed decay). One is the inability to precisely regulate current, which limits micro-stepping resolutions. Conventional fixed-decay also needs to be tuned by the user to identify the most favorable setting. Finally, fixed-decay does not adjust to varying parameters such as supply voltage, load current, back electromotive force (BEMF) and rate of micro-stepping.

The best scheme is often chosen by cycling through the available fixed-decay options while observing current on the oscilloscope.

This is time-consuming and still leads to compromises when choosing the best scheme, such as:

- Optimizing for quick-step rate (by setting a higher mixed-decay percent) leads to excessive ripple in current regulation (while holding in a step).
- Decay scheme for a fresh battery may not be the same for a battery declining in power.
- Optimal decay schemes differ greatly when handling current close to zero when compared to handling current at peak.
- An aggressive decay setting (higher percent of fast decay in the mixed-decay cycle) chosen to counter back electromotive force (BEMF) effects causes excess ripple while regulating current in most steps.
- Initial tuned decay may not be good for a resistive, end-of-life motor.

When searching for improvement in handling decay current, carefully analyzing the limitations can bring about questions. Can we have different decay schemes for different levels of micro-stepping current? Can we separate the decay approach for current regulation and step change? Can the decay scheme change as a response to changing loads, varying supply voltage and changing BEMF? Let's find out.

5 Problem solution

The answers to these questions are yes, yes and yes. The proposed solution addresses two main requirements.

The first is to identify the best possible decay for a given level of current regulation for a given step. In this approach, during current regulation, the controller keeps track of where Itrip (the signal when coil current reaches target current) happens in a given PWM cycle. It recalls from memory the 'Itrip event and timing' from the previous cycle, and then dynamically decides what decay action is needed for the current cycle.

The second is to provide a quick transition from one step to another. As a response to step command, scaling up the percentage of fast decay allows us to aggressively reach a new level in a shorter time, thereby providing a quick-step response.

This solution is incorporated into a stepper motor driver, such as the DRV8846, or smart tune. It is an all-inclusive digital scheme with no tuning required by the user. The solution gives the optimal decay setting in any given situation. This decay setting is modified in real time to changing parameters such as current level, step change, supply, BEMF and load.

6 Advantages

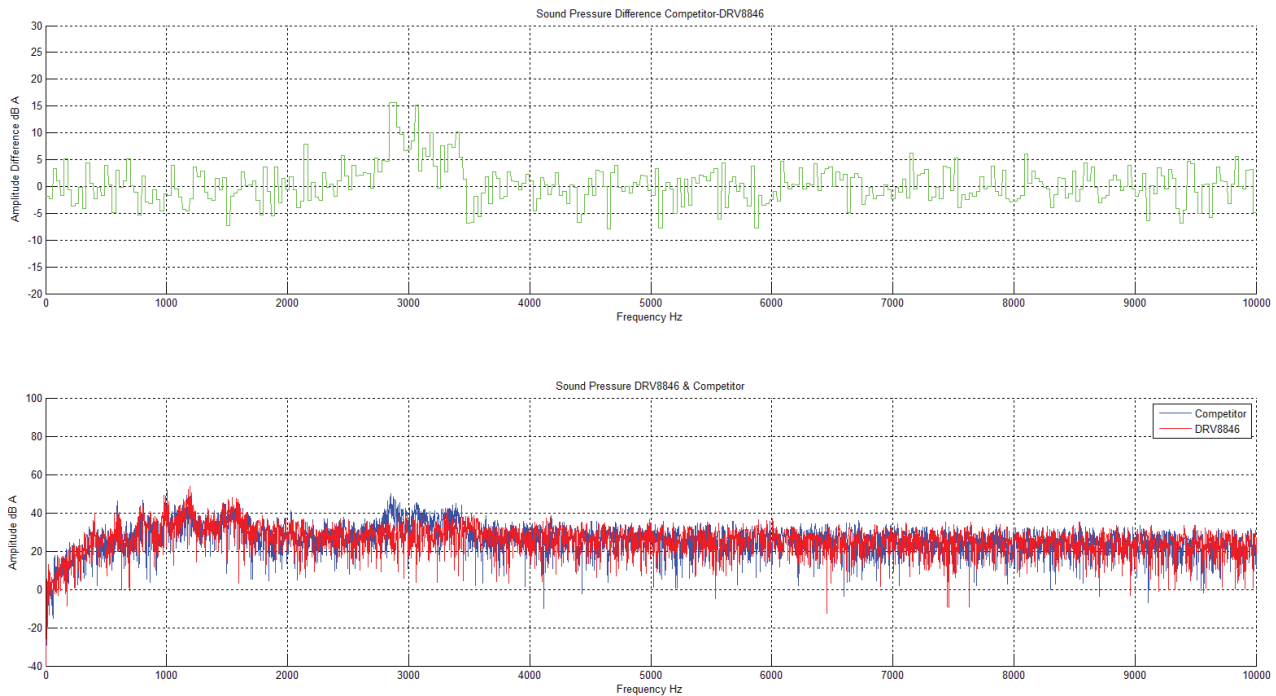

Figure 6-1. The DRV8846 has a noise advantage of 16.5% lower than the nearest competition

There are several advantages to this approach. No tuning is required in an adaptive decay scheme. Also, smaller ripple makes the average current more accurate to the desired step current in peak current detect regulation. This enables higher levels of micro-stepping, leading to smoother motion for the stepper motor. Smaller ripple also reduces noise in the motor and drive electronics, shown in [Figure 6-1](#)

The smart tune decay scheme self-adjusts to changing:

1. supply voltage
2. load inductance
3. load resistance
4. rate of stepping BEMF in a stepper motor
5. magnitude of current to be regulated (torque).

This is all offered without sacrificing ripple and step performance. As an example, [Figure 6-2](#) shows a current waveform without employing adaptive decay. The distortion due to BEMF is eliminated by smart tune. [Figure 6-3](#) shows the current waveform when smart tune is engaged.

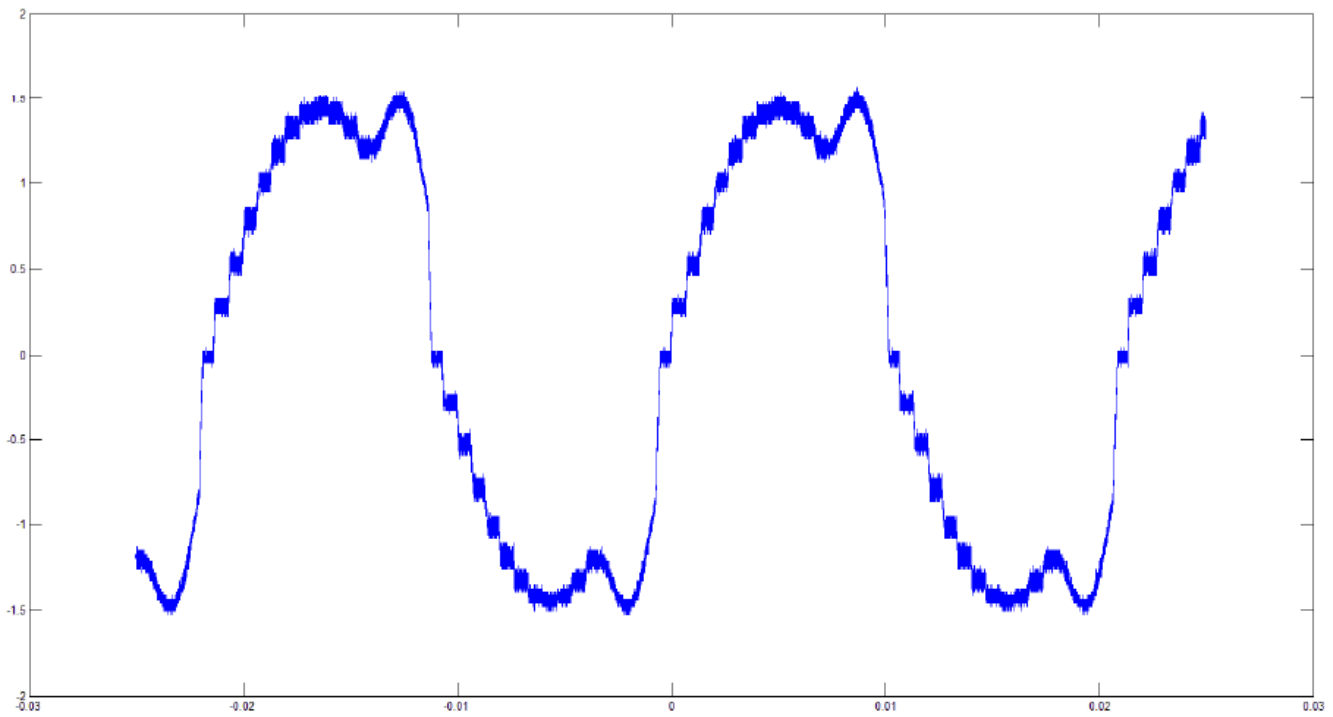

Figure 6-2. Shows loss of current regulation in the presence of BEMF

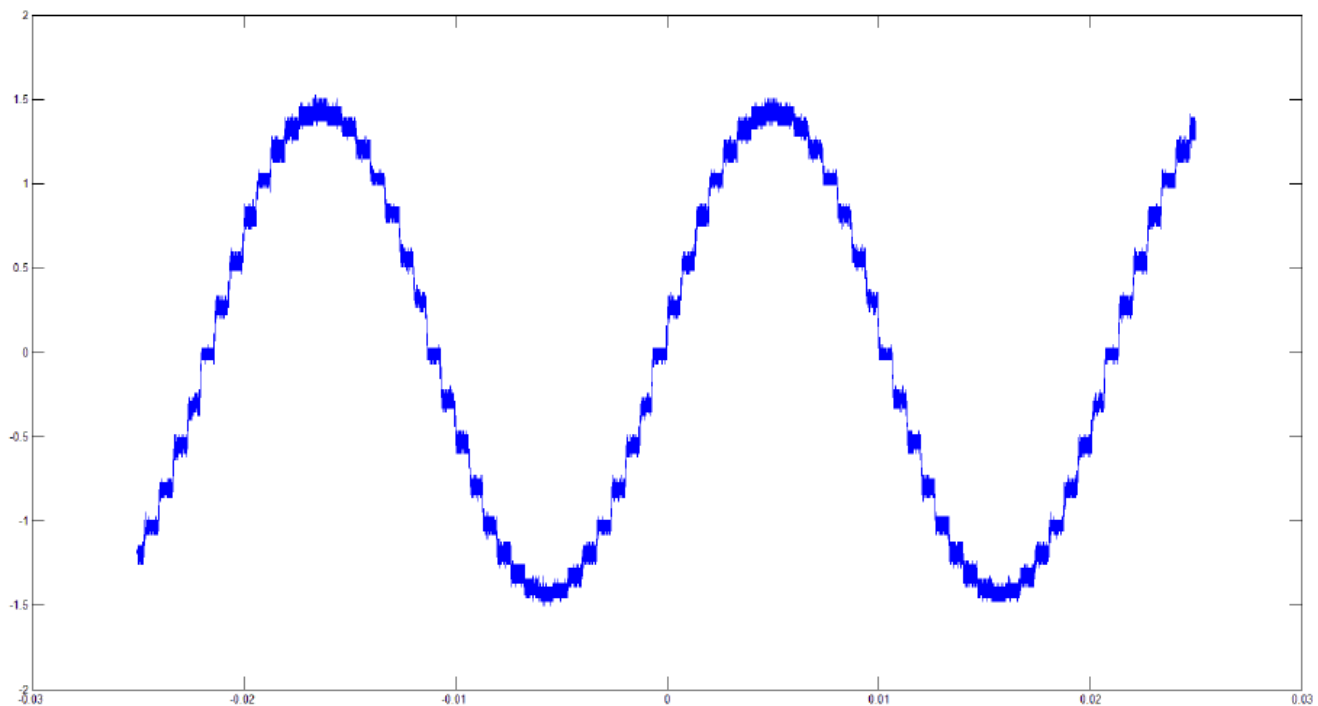

Figure 6-3. This chart shows how a stepper motor with adaptive decay tames BEMF

This scheme saves device pins that set traditional fixed decay, which reduces system cost. This scheme also enables quicker step transition or response time, (Figure 6-4, right plot) than most conventional decay modes (Figure 6-4, left plot), without causing excessive ripple in current regulation while holding a step between adjacent steps. This example provides around a three-times faster step response time.

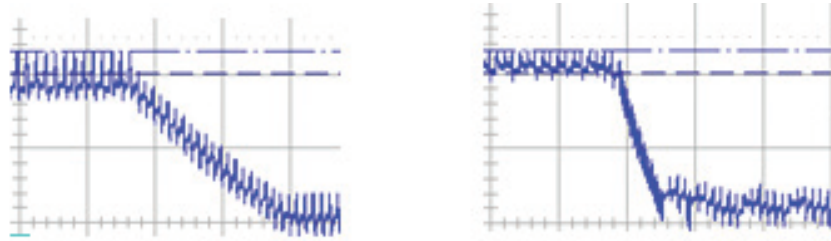

Figure 6-4. A 600 uS step transition in fixed decay vs 200 uS transition in smart tune adaptive decay mode

Using slow decay cycles wherever possible makes an adaptive decay scheme more power-efficient. This is because slow decay minimizes switching losses and is typically done using low-side FETs that are more power-efficient. In the plots in

Figure 6-5, blue is the current in the coil being regulated. Pink and yellow are the H-bridge output voltage waveforms showing output switching. Pink spikes indicate reverse FET voltage for fast/mixed decay. The plot to the right employs smart tune, TI's adaptive decay feature. It uses fast/mixed decay sparingly compared to the fixed-mixed decay case shown in the left plot. This makes using smart tune power efficient.

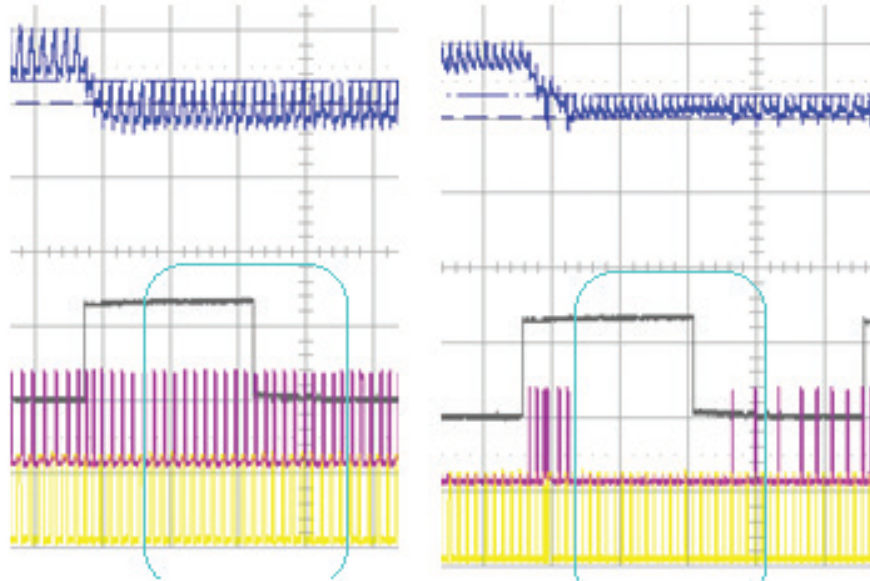

Figure 6-5. Fixed mixed decay versus smart tune

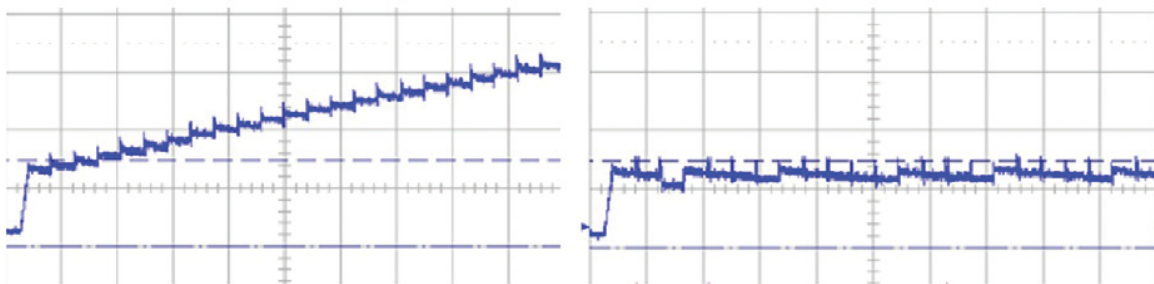

Figure 6-6. Fixed slow decay mode versus smart tune on TI's DRV8846

Low-current regulation (near zero crossing of micro-stepping sine) performance is improved with this adaptive decay scheme. This is because the adaptive decay scheme enables low ripple at lower currents similar to slow decay. However, it does not cause loss of regulation like slow decay does.

Slow decay causes loss of regulation because the amount of current built up during the minimum ON time is greater than the amount of current reduced by slow decay. Slow decay happens due to voltage drop in the

Advantages

current path/loop. The lower the loop current, the smaller the voltage drop. Hence, the smaller amounts of current decayed.

7 Conclusion

An adaptive decay scheme, like TI's smart tune, promises to be the future of decay in motor current regulation. This plug-and-play solution enables greater current regulation and micro-stepping performance. The intelligent solution keeps track and adjusts decay for varying supply voltages, load currents, load inductance BEMF, and motor variations over operating lifetime, ensuring the optimal decay for any given situation. Power efficiency improvement is another key benefit. Higher performance that does not need tuning enables quicker time-to-market. Users no longer need to be concerned about having to tackle decay on their way to spinning a motor successfully.

8 References

1. [Current Recirculation and Decay Modes, Application Report](#)

IMPORTANT NOTICE AND DISCLAIMER

TI PROVIDES TECHNICAL AND RELIABILITY DATA (INCLUDING DATA SHEETS), DESIGN RESOURCES (INCLUDING REFERENCE DESIGNS), APPLICATION OR OTHER DESIGN ADVICE, WEB TOOLS, SAFETY INFORMATION, AND OTHER RESOURCES "AS IS" AND WITH ALL FAULTS, AND DISCLAIMS ALL WARRANTIES, EXPRESS AND IMPLIED, INCLUDING WITHOUT LIMITATION ANY IMPLIED WARRANTIES OF MERCHANTABILITY, FITNESS FOR A PARTICULAR PURPOSE OR NON-INFRINGEMENT OF THIRD PARTY INTELLECTUAL PROPERTY RIGHTS.

These resources are intended for skilled developers designing with TI products. You are solely responsible for (1) selecting the appropriate TI products for your application, (2) designing, validating and testing your application, and (3) ensuring your application meets applicable standards, and any other safety, security, regulatory or other requirements.

These resources are subject to change without notice. TI grants you permission to use these resources only for development of an application that uses the TI products described in the resource. Other reproduction and display of these resources is prohibited. No license is granted to any other TI intellectual property right or to any third party intellectual property right. TI disclaims responsibility for, and you will fully indemnify TI and its representatives against, any claims, damages, costs, losses, and liabilities arising out of your use of these resources.

TI's products are provided subject to [TI's Terms of Sale](#) or other applicable terms available either on ti.com or provided in conjunction with such TI products. TI's provision of these resources does not expand or otherwise alter TI's applicable warranties or warranty disclaimers for TI products.

TI objects to and rejects any additional or different terms you may have proposed.

Mailing Address: Texas Instruments, Post Office Box 655303, Dallas, Texas 75265
Copyright © 2022, Texas Instruments Incorporated