

# **Use Receiver Equalization To Extend RS-485 Data Communications**

*Clark Kinnaird*
*High Performance Analog/Interface Products*

## **ABSTRACT**

Systems designers can use receiver equalization to extend their RS-485 data transmission applications in terms of longer cable distances or higher signaling rates. This application report discusses the benefits of using fixed receiver equalization for specific combinations of signaling rate, cable type, and node-to-node distance. Examples showing discrete implementations and integrated solutions are presented with laboratory results.

## **Contents**

<b>1</b>	<b>Introduction .....</b>	<b>3</b>
<b>2</b>	<b>Problem Statement .....</b>	<b>3</b>
	2.1 Definition of Terms .....	3
	2.2 Sources of Media Losses .....	4
	2.2.1 Cable .....	4
	2.3 Typical Cables Recommended for RS-485 .....	5
	2.4 Measure of Signal Quality .....	6
<b>3</b>	<b>Possible Solutions .....</b>	<b>9</b>
	3.1 Use Better Cable (Media).....	9
	3.2 Theoretical Methods for Signal Recovery .....	9
	3.3 Driver Preemphasis.....	10
	3.4 Receiver Gain Increase.....	11
	3.5 Data Coding .....	12
	3.6 Receiver Equalization.....	12
<b>4</b>	<b>Receiver Equalization Implementations .....</b>	<b>13</b>
	4.1 Passive Analog Filters.....	13
	4.2 Active Analog Filters (Various Orders).....	13
	4.3 Integrated Receiver Equalization .....	15
<b>5</b>	<b>Test Results.....</b>	<b>16</b>
	5.1 Receiver Equalization Using THS4140 Differential Amplifier .....	16
	5.2 Integrated Receiver Equalization Using HVD23.....	19
	5.3 Integrated Receiver Equalization Using HVD24.....	20
	5.4 Bit Error Rate (BER) Test Results.....	23
	5.5 Limitations of Receiver Equalization .....	24
<b>6</b>	<b>Applications.....</b>	<b>26</b>
<b>7</b>	<b>Conclusion.....</b>	<b>28</b>
<b>8</b>	<b>References.....</b>	<b>28</b>

## **Figures**

<b>Figure 1.</b>	<b>RS-485 Data Transmission System .....</b>	<b>4</b>
<b>Figure 2.</b>	<b>Frequency Response of 300-Meter Cable .....</b>	<b>5</b>
<b>Figure 3.</b>	<b>Using the Eye Pattern to Measure Signal Transmission Quality.....</b>	<b>7</b>

<b>Figure 4.</b>	<b>10 Mbps Data Through 1-Meter Cable .....</b>	<b>7</b>
<b>Figure 5.</b>	<b>10-Mbps Data Through 300-Meter Cable .....</b>	<b>8</b>
<b>Figure 6.</b>	<b>Transmission Chain With Signal Pre-Compensation .....</b>	<b>10</b>
<b>Figure 7.</b>	<b>Transmission Chain With Signal Recovery .....</b>	<b>10</b>
<b>Figure 8.</b>	<b>Signal Preemphasis at the Driver .....</b>	<b>11</b>
<b>Figure 9.</b>	<b>Signal Restoration With Receiver Equalization.....</b>	<b>12</b>
<b>Figure 10.</b>	<b>Finite Order Approximations to Cable Attenuation .....</b>	<b>14</b>
<b>Figure 11.</b>	<b>Cable Losses and Equalizer Design Example .....</b>	<b>14</b>
<b>Figure 12.</b>	<b>Schematic of Receiver Equalization Using THS4140 Differential Operational Amplifier.....</b>	<b>15</b>
<b>Figure 13.</b>	<b>SN65HVD2X Family of Transceivers With Receiver Equalization .....</b>	<b>16</b>
<b>Figure 14.</b>	<b>Frequency Response of THS4140 Receiver Equalization Stage .....</b>	<b>17</b>
<b>Figure 15.</b>	<b>10-Mbps Data Through 300-Meter Cable With THS4140 Equalization.....</b>	<b>18</b>
<b>Figure 16.</b>	<b>10-Mbps Data Through 1-Meter Cable With THS4140 Equalization.....</b>	<b>19</b>
<b>Figure 17.</b>	<b>LTC1485, 160 m, 25 Mbps.....</b>	<b>19</b>
<b>Figure 18.</b>	<b>MAX485, 160 m, 25 Mbps.....</b>	<b>20</b>
<b>Figure 19.</b>	<b>SN65HVD23, 160 m, 25 Mbps .....</b>	<b>20</b>
<b>Figure 20.</b>	<b>SN65HVD21, 500 m, 5 Mbps .....</b>	<b>21</b>
<b>Figure 21.</b>	<b>SN65HVD24, 500 m, 5 Mbps .....</b>	<b>21</b>
<b>Figure 22.</b>	<b>SN65HVD21, 1000 m, 2 Mbps .....</b>	<b>22</b>
<b>Figure 23.</b>	<b>SN65HVD24, 1000 m, 2 Mbps .....</b>	<b>22</b>
<b>Figure 24.</b>	<b>SN65HVD21, 1500 m, 1 Mbps .....</b>	<b>23</b>
<b>Figure 25.</b>	<b>SN65HVD24, 1500 m, 1 Mbps .....</b>	<b>23</b>
<b>Figure 26.</b>	<b>Sensitivity vs. Frequency Test Circuit .....</b>	<b>25</b>
<b>Figure 27.</b>	<b>Comparative Sensitivity With and Without Receiver Equalization .....</b>	<b>25</b>
<b>Figure 28.</b>	<b>Factory Automation Example.....</b>	<b>26</b>
<b>Figure 29.</b>	<b>SN65HVD21, 500-m Cable, 2 Mbps .....</b>	<b>27</b>
<b>Figure 30.</b>	<b>SN65HVD24, 500-m Cable, 7.5 Mbps .....</b>	<b>27</b>

**Tables**

<b>Table 1.</b>	<b>RS-485 Cable Parameters.....</b>	<b>6</b>
<b>Table 2.</b>	<b>Results of BER Testing.....</b>	<b>24</b>

## **1 Introduction**

RS-485 data transmission, conforming to the ANSI TIA/EIA-485-A standard, is a common method of communicating serial digital data across relatively long distances at relatively high data rates. Cable lengths of up to 1200 meters are possible at slow signaling rates. Signaling rates up to about 30 megabits per second (Mbps) are possible with short cable lengths. The non-ideal characteristics of the wired network medium (usually twisted-pair cable) force this trade-off between signaling rate and transmission distance. However, systems designers face several strong trends that require pushing the envelope of these physical constraints.

One recognizable trend that cuts across many applications is the movement towards increased networking among electronic devices. This is seen in areas as diverse as point-of-sales networks, industrial process control, medical systems, and building automation.

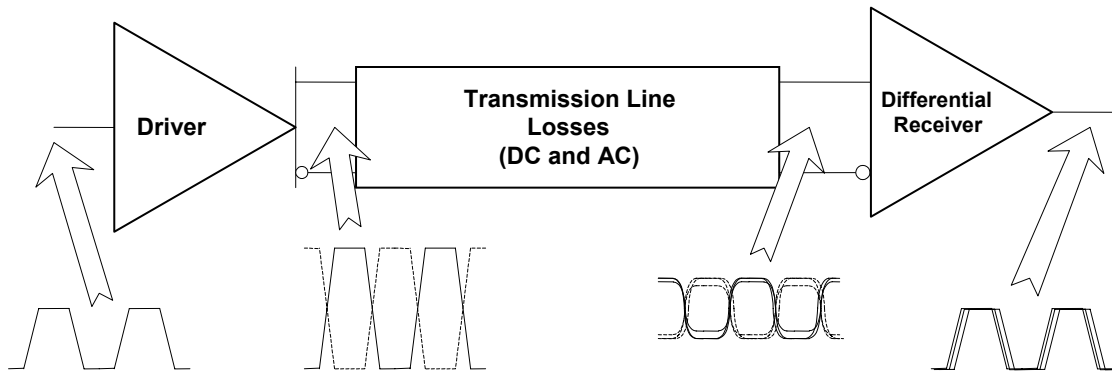
Coupled with the rise of inexpensive sensors and displays distributed throughout a system, these technologies allow for increased functionality and drive a need for communicating more data, more often around a growing network of electronic nodes.

To support the trend toward increased connectivity, this application report examines methods to optimize data transmission across an RS-485 network. The real characteristics of the wired network medium are discussed, and the impact on data communication is quantified. Finally, this report offers receiver equalization as one method of optimizing the wired data network and presents results showing improvement in data fidelity and throughput using the proposed implementation

## **2 Problem Statement**

### **2.1 Definition of Terms**

In an RS-485 data transmission system (see Figure 1), the signals are transmitted differentially; so, it is the difference in voltage between the two bus lines that carries the data. The driver device generates the signal voltages on the bus lines. The signal propagates through the media, usually a twisted pair of wires. The receiver device compares the signals on the two bus lines and outputs a single-ended (nondifferential) signal representing the received data.



**Figure 1. RS-485 Data Transmission System**

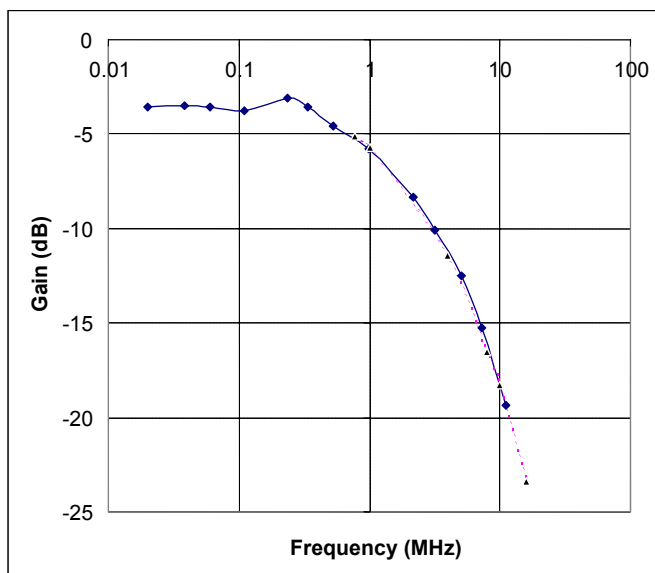
Because many RS-485 applications involve relatively long cable lengths, the bus lines are often modeled as a transmission line, rather than a “lumped” connection. This implies that the signal takes a non-negligible amount of time to propagate through the cable. Usually, the attenuation (reduction in signal amplitude) must also be considered for RS-485 systems.

## 2.2 Sources of Media Losses

### 2.2.1 Cable

All real cables have losses due to the conductor resistance and inductance, capacitance between the lines, and insulation leakage. The magnitude and frequency specifics of the losses depend on the characteristics of the cable, including the conductor size, insulation type, shielding, etc. In general, cables can be described by their DC resistance per unit length, their characteristic impedance, and their attenuation versus frequency.

In order to design an appropriate receiver equalization stage, the characteristics of the transmission medium should be understood. The solid line in Figure 2 shows the measured attenuation (as negative gain) for a typical 300-meter cable. Note that for frequencies above 1 MHz, there is significant attenuation. This causes rounding of the signal edges, which can lead to the intersymbol interference as seen in Figure 5.



**Figure 2. Frequency Response of 300-Meter Cable**

Like cables, the printed-circuit board traces and connectors in a system have an effect on signals. For applications where high signaling rates (>100 Mbps) over short cables or backplanes are of interest, the connectors and board traces become significant. Several Texas Instruments applications reports, such as SLLA104, *Suggestions for LVDS Connections* and SLLA014, *Low-Voltage Differential Signaling (LVDS) Design Notes* (see Reference 1 and Reference 2, respectively) address these concerns. Although focusing on LVDS applications, the design guidelines regarding circuit board traces and connector selection in these documents also apply to RS-485 applications with high signaling rates.

However, in a typical RS-485 application, the losses due to the cable dominate the characteristics of the entire interconnection chain. This is especially true for applications where relatively long cables are used at moderate signaling rates (30 Mbps or less). Therefore, this application report focuses on the effects due to cable losses.

### 2.3 Typical Cables Recommended for RS-485

Several cable manufacturers make cables with parameters specified for RS-485 data communications. The descriptions of these are similar; the key attributes are the balanced twisted pair of conductors with 120-Ω characteristic impedance (see Table 1). The shielding features of these cables reflect the common use of RS-485 in applications with harsh electrical environments. Typical sources of electrical noise include motors, high-current relay contacts, and power-switching devices.

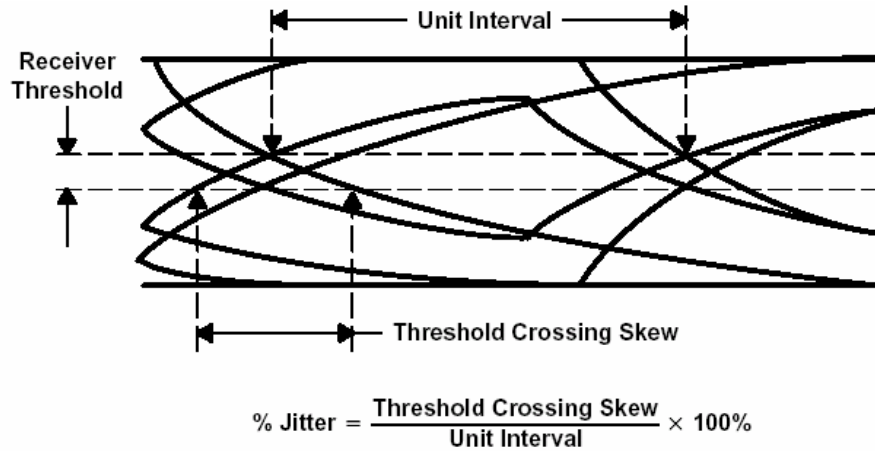
**Table 1. RS-485 Cable Parameters**

<b>Manufacturer</b>	<b>Belden</b>	<b>CommScope</b>	<b>Madison (Tyco)</b>
Part number	3105A	5090	02KFK0003
Number of conductors	1 pair + drain	1 pair + drain	1 pair
Conductor size	22 AWG (7 x 30)	22 AWG	24 AWG (7 x 32)
Insulation	Foam polyethylene	Foam polyethylene	Foam polyethylene
Shield 1	Al foil/polyester tape	Al foil/polyester tape	Al foil/polyester tape
Shield 2	Tinned copper braid	36 AWG tinned copper braid	Tin copper braid
Jacket	PVC	PVC	PVC
Differential impedance	120 $\Omega$	120 $\Omega$	120 $\Omega$
Velocity of propagation	78% c	78% c	78% c
Conductor DCR	17.5 $\Omega$ /kft	14.7 $\Omega$ /kft	
Shield DCR	2.8 $\Omega$ /kft	2.9 $\Omega$ /kft	
Differential capacitance	11 pF/ft	11 pF/ft	11 pF/ft
Attenuation (@1 MHz)	0.5 dB/100 ft		
Twist length	2.5 in.		

## 2.4 Measure of Signal Quality

Signal quality in a data transmission system can be described in several ways. At a high level, the bit error rate (BER) describes the number of transmission errors encountered, specified in terms of errors per million (or more) bits transmitted. This is a measure of the overall system; testing involves observing the data stream at the receiver end of the channel while stimulating the driver with a known data pattern. In later sections, BER test results are presented to demonstrate and compare the advantages of receiver equalization.

Another common method is the eye pattern, which can visually display the transceiver- and cable-induced signal effects on a stream of data bits. Texas Instruments' design note SLLA036, *Interface Circuits for TIA/EIA-485 (RS-485)* (see Reference 3) discusses setting up the eye pattern and associated measurement techniques. Figure 3, taken from that document, shows how jitter can be measured as an indicator of signal quality. For the purposes of this report, the eye pattern is used to illustrate and compare data transmission systems, using jitter measurements to contrast receivers with and without receiver equalization.

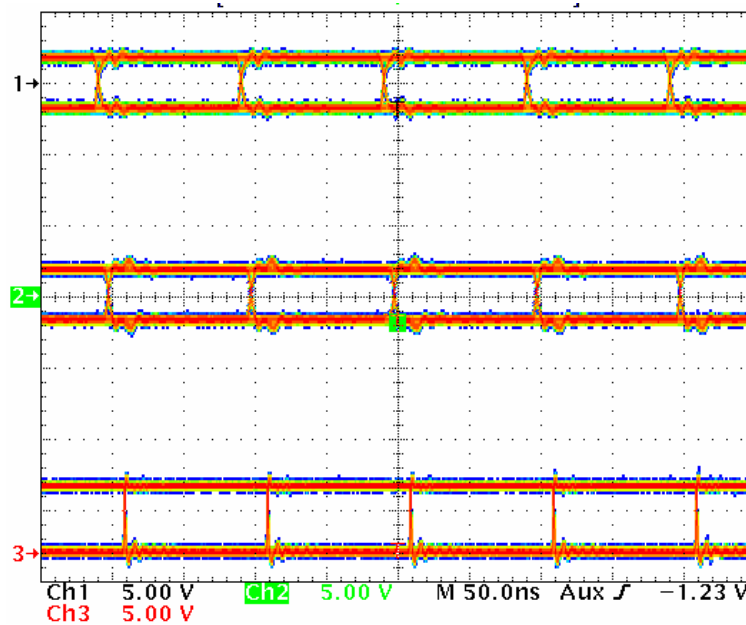


**Figure 3. Using the Eye Pattern to Measure Signal Transmission Quality**

Figure 4 shows the output of an SN65LBC176A driver on channel 1, switching between binary logic states according to a pseudo-random sequence. The time between data bits is 100 ns, corresponding to a signaling rate of 10 Mbps. Note the clean transitions between bits.

The signal on channel 2 is the input to an LBC176A receiver. In this case, the cable was only 1 meter long; a single twisted pair, terminated by a matching 100-Ω resistor, was used to carry the differential signals

Channel 3 shows the output of the LBC176A receiver. Note that the data signal state can be reliably sampled for most of the bit time. Little signal degradation occurred through the short cable.



**Figure 4. 10 Mbps Data Through 1-Meter Cable**

In Figure 5, the effect of increasing the cable length is illustrated. The signal on channel 1 is again the pseudo-random data transmitted by the SN65LBC176A configured as a driver. The signaling rate is 10 Mbps.

As before, the signal on channel 2 is the input to the second SN65LBC176A configured as a receiver. Here, the long transmission cable degrades the signal clarity (eye pattern). In this case, the cable was a 300-meter length of CommScope part number 5524, which is comprised of several unshielded twisted pairs (UTP). A single twisted pair, terminated by a matching 100-Ω resistor, carried the differential signals shown; all other twisted pairs were left open.

Channel 3 shows the output of the SN65LBC176A receiver and highlights the signal jitter caused by the intersymbol interference through the cable. Note that the bit state can be reliably determined during only about 20% of the bit time. During the other 80% of the bit time, the data may be transitioning between states.

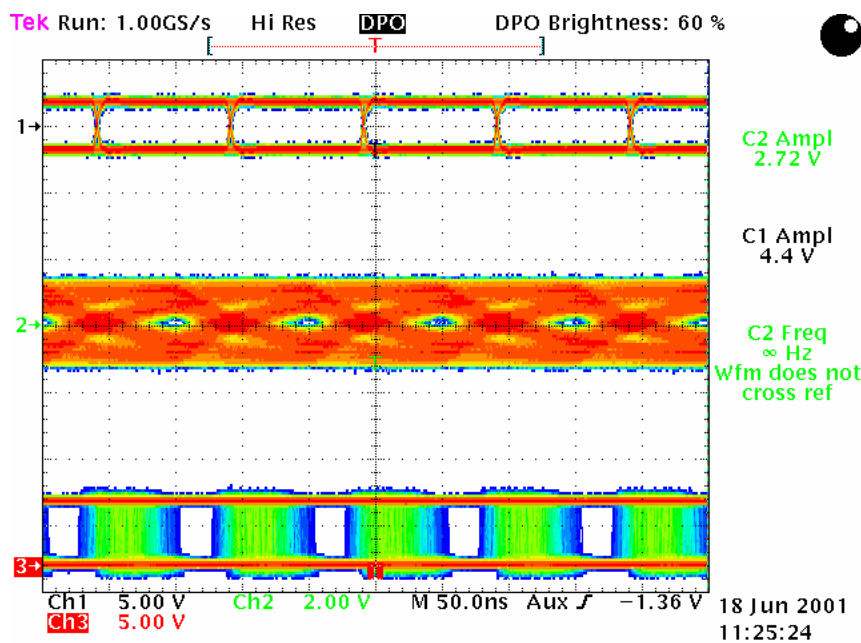


Figure 5. 10-Mbps Data Through 300-Meter Cable



### 3 Possible Solutions

#### 3.1 Use Better Cable (Media)

One of the most straightforward methods of solving the media loss problem is to invest in the best available cable, with low losses. Several technical references (see References 4 and 5) and cable manufacturers (see References 6, 7, 8, and 9) offer detailed technical data including curves of attenuation versus frequency for various cable types. Selecting the cable with the lowest attenuation across the frequencies of interest for an application helps ensure reliable data transmission. However, other factors often are competing with signal fidelity when cable is selected, including:

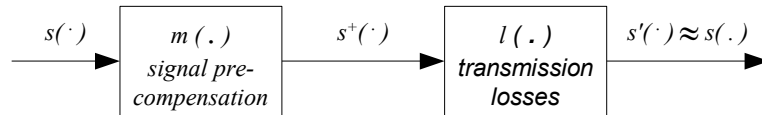
- Impedance
- Standard compliance
- Insulation abrasion toughness and chemical resistance
- Flexibility (flex life and bend radius)
- Shielding
- Dielectric rating
- Temperature rating
- Solderability
- Flame resistance
- Size
- Weight
- Cost

Beyond these factors, many applications are constrained to use existing cable media. If a network already exists, and the electronics at the nodes are being replaced, the cost of upgrading the cable infrastructure may be prohibitive. Similarly, if an existing network is being expanded, the new cable should be compatible with the existing installation. These situations may cause a network designer to use other than the cable best suited for maximum data transmission performance. In these cases, it may be necessary to use an active method to compensate for the undesirable losses in the cable.

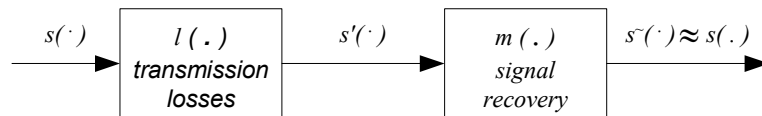
#### 3.2 Theoretical Methods for Signal Recovery

When it is not possible or practical to eliminate signal losses by use of better cable, several methods can be used to compensate for or recover the lost signal components. These methods seek to ensure that the signal at the end of the transmission chain reproduces the significant features of the intended signal.

If a signal  $s(\cdot)$  is to be transmitted through a medium with loss characteristics  $l(\cdot)$ , the resulting signal  $s'(\cdot)$  will be a distorted version of the original signal. To the extent that there is some function that can invert or undo the effect of the transmission medium, then the original signal can be recovered. The approach, therefore, is to find and implement the necessary function  $m(\cdot) = 1/l(\cdot)$  as effectively as possible. Part of that design involves choosing whether to pre-compensate at the driver end of the chain (for example, with driver preemphasis (see Figure 6)), or whether to apply a recovery method at the receiver end of the chain, as with receiver equalization (see Figure 7). Discussion of the variations of these methods follows.



**Figure 6. Transmission Chain With Signal Pre-Compensation**



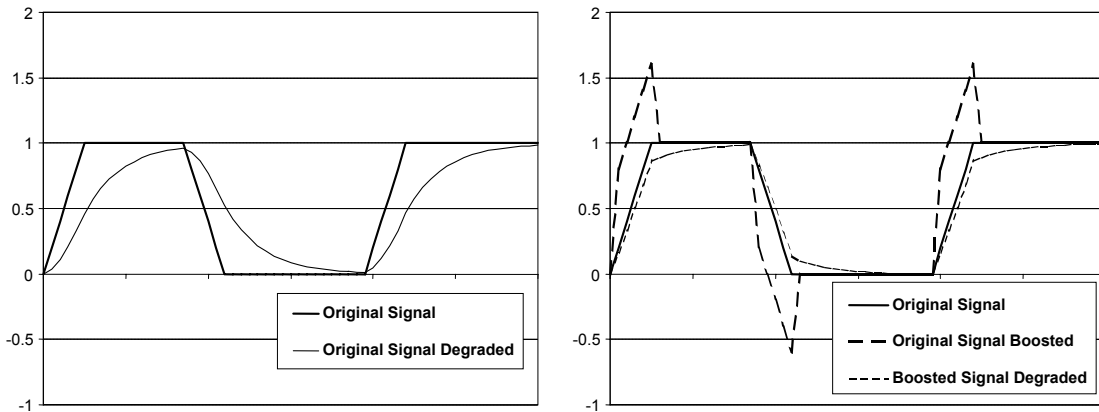
**Figure 7. Transmission Chain With Signal Recovery**

### 3.3 Driver Preemphasis

Driver preemphasis alters the original signal at the source (driver) in order to boost the high-frequency content. Then as the altered signal is transmitted down the cable, the high-frequency content is attenuated, and the signal at the destination (receiver) has characteristics similar to the original signal. If the attenuation characteristics of the cable are known, theoretically the preemphasis can exactly compensate for the cable losses.

In practice, several methods can increase the signal's high-frequency content at the driver. One method is the time-domain technique of boosting the drive signal amplitude for a period at each signal transition (see Reference 10).

This is illustrated in Figure 8, which shows that with proper shaping, much of the original signal characteristics can be transmitted to the receiver. Another method of preemphasis is the frequency-domain technique of adding tuned high-pass filters to the driver.



**Figure 8. Signal Preemphasis at the Driver**

Driver preemphasis does have limitations. First, knowledge of the attenuation characteristics of the cable is necessary. For general applications, the designer may not know the cable part number or length between driver and receiver for any specific application. Therefore, the exact amount of emphasis needed is typically unknown. A second limitation for applications requiring equipment interchangeability is that the signal with driver preemphasis does not typically conform to the TIA/EIA-485-A standard, which allows less than 10% overshoot during signal transitions.

A third concern is the increase in high-frequency electrical noise emissions from a signal with preemphasis. Although the differential nature of RS-485 signaling assumes balanced, and therefore self-canceling signal transitions, any imbalance in the loading or driver transitions generates noise that is not cancelled. This can be of special concern where electromagnetic compatibility (EMC) requirements restrict the generation of high-frequency emissions.

Finally, driver preemphasis requires more power for each bit; the increase may be significant due to the square-law relation between signal voltage and signal power. For example, boosting the drive voltage from 1.5 V to 2 V on a 50-Ω load nearly doubles the instantaneous power consumption.

### 3.4 Receiver Gain Increase

The simplest way of overcoming the effects of cable losses is to increase the sensitivity of the receiver. If the maximum attenuation of frequencies of interest is 20 dB, increasing the receiver gain by a factor of ten more than compensates for the cable. However, the term *more than compensates* in this case implies that all frequencies, from both signal and noise, will be amplified by the same factor. Therefore, the receiver with higher gain is more sensitive to noise across its entire bandwidth.

### 3.5 Data Coding

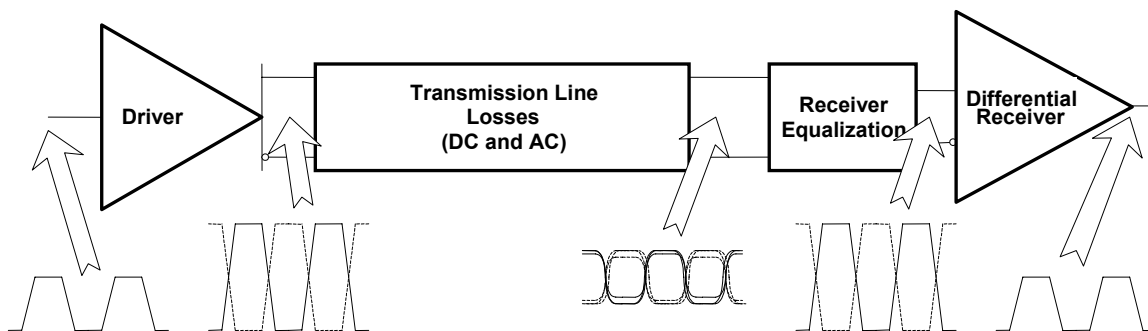
So far, it has been assumed that the data being transmitted across the network is not encoded (baseband) signals for which the differential voltage level of each bit holds the information. For general data at a signaling rate of  $R$  bits per second, this requires passing all frequencies from zero (DC) up to several multiples of  $R$ . An equalized receiver for this application therefore requires a fairly flat response from DC up to about  $5R$ . Encoding the data can eliminate the DC content. This is sometimes done using Manchester (or biphase) encoding, which encodes the data to give zero DC content. Manchester-encoded data requires signaling at twice the data bit rate. Therefore, the frequency band for Manchester-encoded data is from  $R$  to about  $10R$ . If the channel characteristics for this portion of the frequency spectrum are more constant than for the baseband portion, encoding may help overcome the cable loss problem. Other encoding schemes, such as 8B10, also shift the frequency content of the data and may be of interest.

In many RS-485 applications, restrictions on data encoding act as a means of coping with channel losses. In some applications, the higher signaling rate required to pass encoded data may not be feasible due to hardware limitations. In other cases, the higher level protocol, such as Profibus, may not allow data encoding.

### 3.6 Receiver Equalization

Receiver equalization refers to a method of restoring a signal's high-frequency components that the media preferentially attenuates. This method is performed at the receiver end of the bus lines and serves to equalize the relative amounts of signal across all frequencies of interest.

Figure 9 illustrates the concept of receiver equalization. The driver can be any standard RS-485 differential transceiver. The transmission line attenuates the signal according to the frequency-dependent characteristics of the cable and connectors. If the receiver equalization is well tuned to the transmission line losses, the original differential signal can be restored at the input of the differential receiver.



**Figure 9. Signal Restoration With Receiver Equalization**

One advantage of receiver equalization is that the impact is limited to the receiving end of the data transmission bus. A transceiver that implements receiver equalization can be used in an existing system, with no effect on the bus signal levels. Another advantage of this method is that it can be adapted to optimize performance with the actual signals received. Several implementations of receiver equalization are discussed in the following sections.

## **4 Receiver Equalization Implementations**

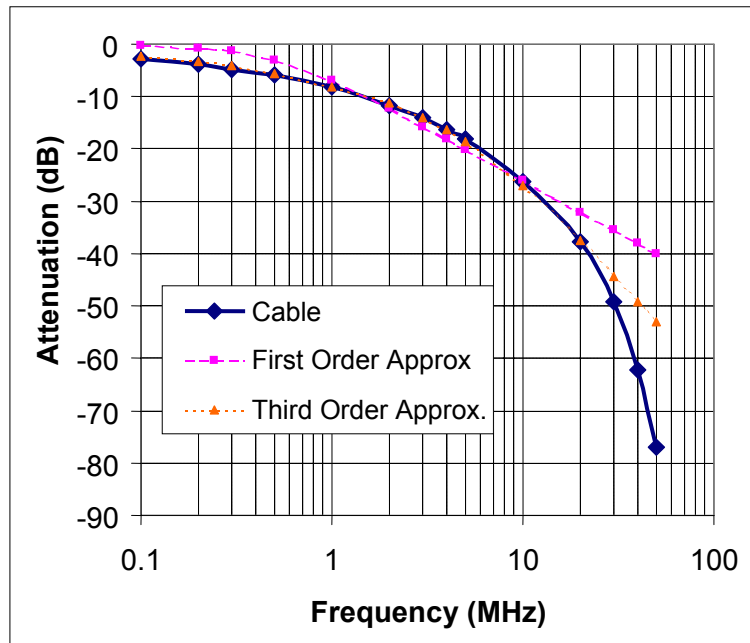
### **4.1 Passive Analog Filters**

Passive filters, made entirely of resistive, capacitive, and/or inductive elements can be used to make a frequency-selective filter. Typically, the filter attenuates low-frequency components while leaving the high-frequency components, which the cable attenuates, intact. This produces an overall flat response. Of course, the disadvantage of the passive filter is that it attenuates all frequencies resulting in less signal energy and therefore decreased noise margin.

### **4.2 Active Analog Filters (Various Orders)**

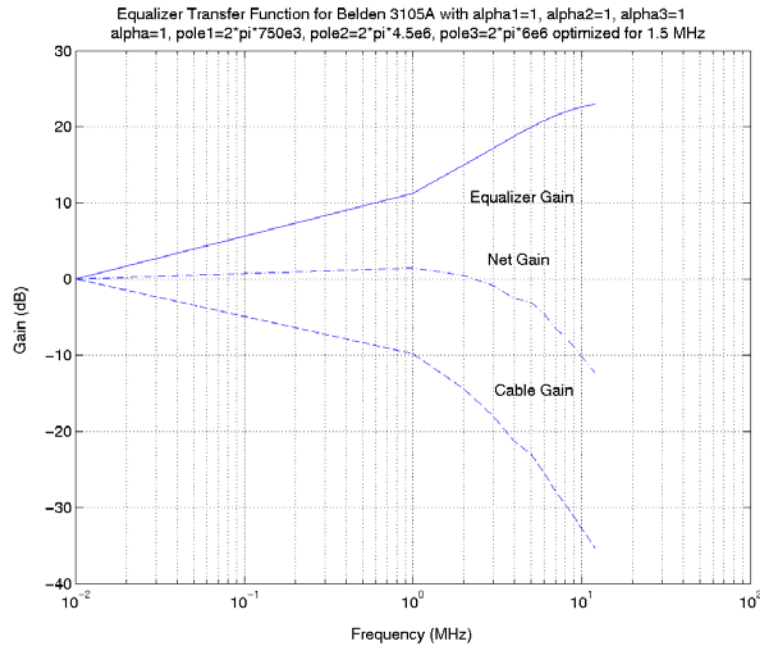
Active filters, using discrete transistors or operational amplifiers, can overcome the signal-loss limitations of passive filters. Using proven filter design techniques, an appropriate high-pass filter can be designed to compensate for high-frequency losses in the cable. The design parameters for any specific design are the order of the filter, the shape of the filter, and the critical frequencies.

Transmission line theory models the cable as an infinite series of connected resistor-inductor-capacitor (RLC) elements. This leads to a frequency-domain model of the cable as a low-pass filter with an infinite number of poles. In practice, the cable attenuation, and therefore the corresponding receiver equalization, can be approximated with a finite number of poles. For example, Figure 10 shows how closely a first-order low-pass and a third-order low-pass function approximate the attenuation of 500 meters of cable. The first-order approximation is relatively accurate for frequencies up to about 1 MHz. For frequencies up to 10 MHz or beyond, the third-order approximation is relatively accurate. Higher order approximations can be used if necessary.



**Figure 10. Finite Order Approximations to Cable Attenuation**

If the characteristics of the data transmission channel (cable, connectors, etc.) are known or can be estimated, an appropriate equalization function can be designed to compensate for the losses to the frequency components of interest. Figure 11 shows such a design.



**Figure 11. Cable Losses and Equalizer Design Example**

RS-485 presents additional challenges in designing a receiver equalization stage, due to the signaling rate, balanced differential signaling, and the wide common-mode range specified by the TIA/EIA standard. The THS4140 high-speed, fully differential amplifier is one solution. This device offers true differential inputs and outputs, with unity-gain frequency response up to 160 MHz. The common-mode input range for the THS4140 is up to  $\pm 15$  V, which accommodates the RS-485 range of  $-7$  V to 12 V.

By designing a differential high-pass filter as shown in Figure 12, a single-pole receiver equalization stage is created. Note that the application determines resistor and capacitor values. The designer selects the R and C values for high-pass characteristics that match the cable attenuation.

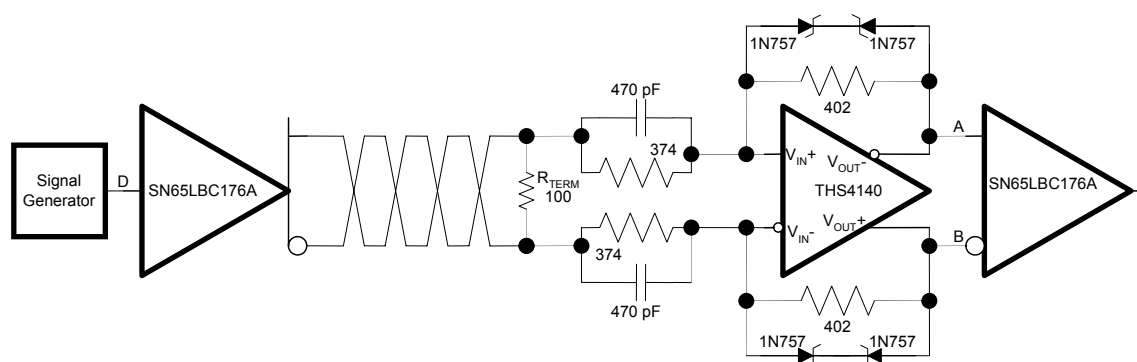


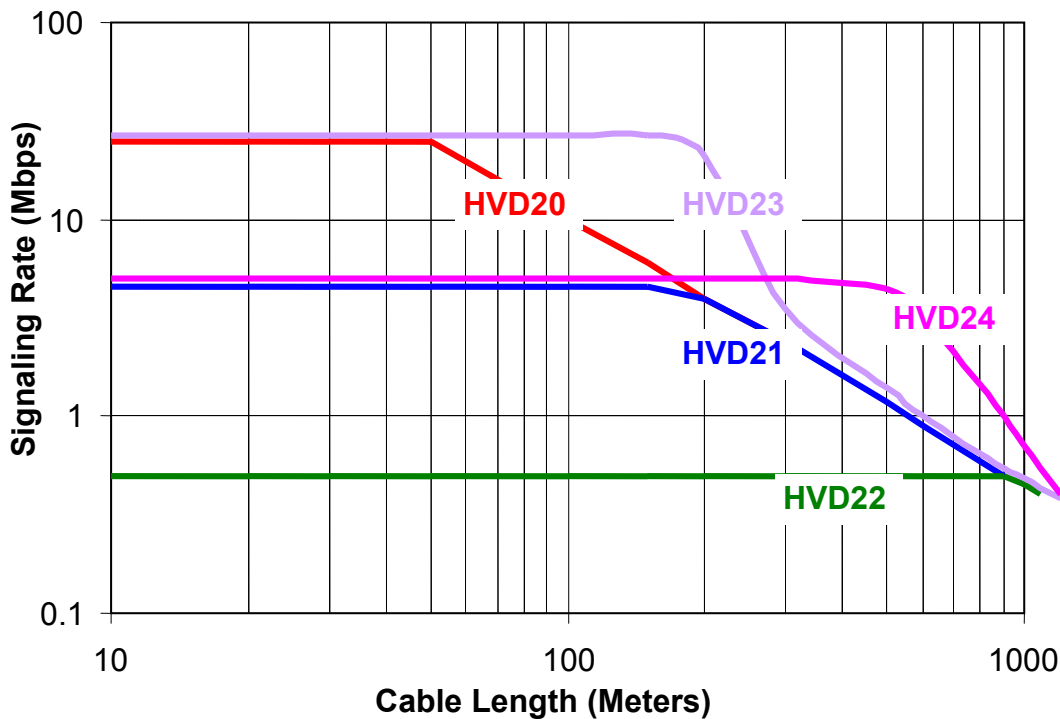
Figure 12. Schematic of Receiver Equalization Using THS4140 Differential Operational Amplifier

### 4.3 Integrated Receiver Equalization

Texas Instruments now offers RS-485 transceivers with integrated receiver equalization features. Both the SN65HVD23 and SN65HVD24 have receiver equalization stages based on third-order active filters. The critical frequencies of the filters have been selected to match particular application ranges.

The SN65HVD23 is optimized for signaling rates around 25 Mbps with cable lengths of up to 200 meters. This is especially suitable for applications with relatively high signaling rates needing longer cable length capability. Examples would be Profibus networks operating at 12 Mbps, or motion-control applications with cable length requirements up to 200 meters, where faster signaling rates correspond to higher allowable resolution of positions.

The SN65HVD24 is optimized for signaling rates around 5 Mbps with cable lengths of up to 500 meters. Figure 13 illustrates the recommended application capabilities of the SN65HVD23 and SN65HVD24, as well as the other transceivers in this family. Note that the sloping boundary line formed by the SN65HVD20, SN65HVD21, and SN65HVD22 conforms to the guideline given in TSB-89, *Application Guidelines for TIA/EIA-485-A*.



**Figure 13. SN65HVD2X Family of Transceivers With Receiver Equalization**

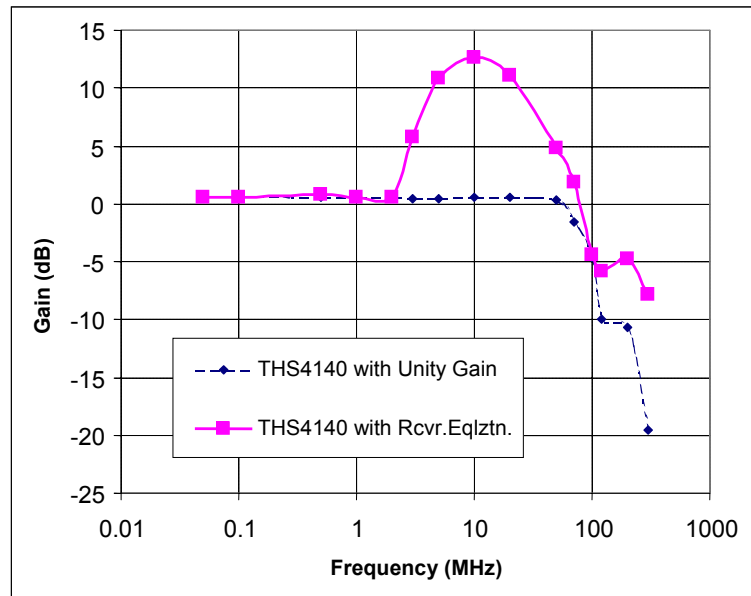
In addition to the receiver equalization feature, the transceivers in the HVD2X family have other features making them well suited for these particular application spaces. These transceivers offer performance far exceeding typical RS-485 devices. In addition to meeting all requirements of the TIA/EIA-485-A standard, the SN65HVD2x family operates over an extended range of common-mode voltage and has features such as high ESD protection, wide receiver hysteresis, and fail-safe operation. This family of devices is ideally suited for long cable networks and other applications where the environment is too harsh for ordinary transceivers.

## 5 Test Results

### 5.1 Receiver Equalization Using THS4140 Differential Amplifier

In order to compensate for the high-frequency losses through the cable, the receiver equalization stage must have increased gain for these frequencies of interest. Figure 14 shows the gain versus frequency and illustrates how the bandwidth of the THS4140 operational amplifier rolls off. This reduces the sensitivity of the receiver equalization stage to high-frequency noise.



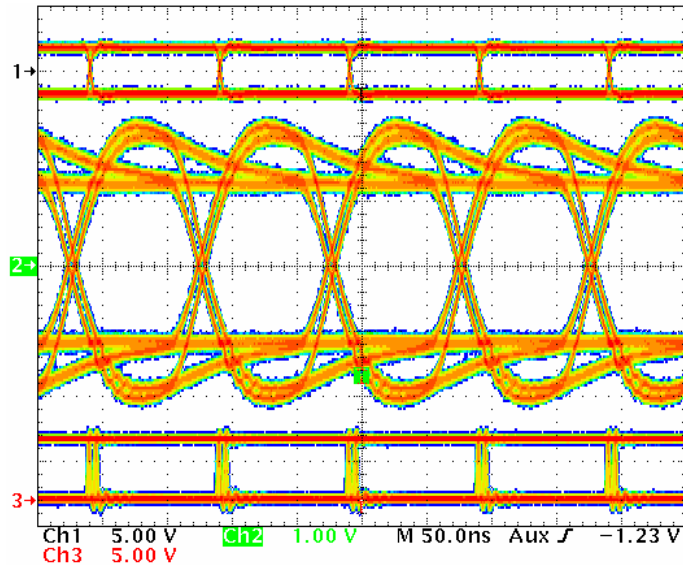


**Figure 14. Frequency Response of THS4140 Receiver Equalization Stage**

Figure 15 shows the benefit of adding a receiver equalization stage into the data transmission system first described with reference to Figure 5. The signal on channel 1 is again the pseudo-random data transmitted by the SN65LBC176A configured as a driver. The signaling rate is again 10 Mbps.

As before, the signal on channel 2 is the input to the second SN65LBC176A, configured as a receiver. The transmission channel was the same 300-m cable as in Figure 5. However, the equalization stage of the receiver restores the high-frequency components of the signal.

Channel 3 shows the output of the LBC176A receiver, and highlights the improvement in signal jitter. Note that the signal state can be reliably determined during about 80% of the bit time. Compare this to Channel 3 of Figure 5, where the signal state can be reliably determined during only about 20% of the bit time.



**Figure 15. 10-Mbps Data Through 300-Meter Cable With THS4140 Equalization**

In order to illustrate that the addition of the receiver equalization stage does not degrade the transmission system performance for short cable lengths, the measurements were repeated using the receiver equalization stage with the 1-meter cable. Figure 16 illustrates this case.

Channel 1 is the output of the SN65LBC176A driver. As before, it is transmitting a pseudo-random sequence of data at a signaling rate of 10 Mbps.

Channel 2 shows the input to the second SN65LBC176A, configured as a receiver. At this point, the signal has been through the 1-meter cable and through the receiver equalization stage. Note that the amplitude of the differential signal increases due to the effect of the high-pass filter in the receiver equalization stage.

The data at the output of the SN65LBC176A receiver is shown on channel 3. Compare this signal to the receiver output signal on channel 3 in Figure 4, and note that the receiver equalization stage does not degrade the signal.

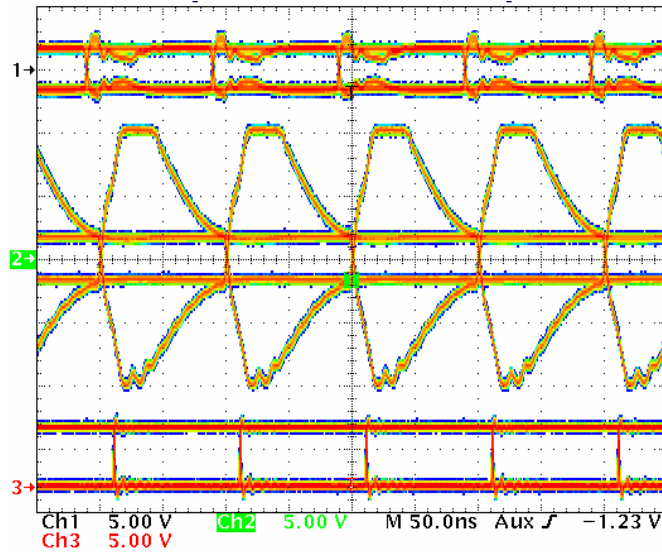


Figure 16. 10-Mbps Data Through 1-Meter Cable With THS4140 Equalization

## 5.2 Integrated Receiver Equalization Using HVD23

Figure 17, Figure 18, and Figure 19 illustrate the benefits of integrated receiver equalization as implemented in the SN65HVD23 transceiver. Each case compares the performance of the SN65HVD23 (with receiver equalization) to the performance of competitive transceivers (without receiver equalization). The test setup was identical for these figures; a differential signal generator applied a signal voltage at one end of 160 m of Belden 1872A twisted-pair cable. The test signal was a 25-Mbps pseudo-random bit stream (PRBS) of non-return-to-zero (NRZ) data. Channel 2 (top) shows the eye pattern of the differential voltage at the receiver inputs (after the cable attenuation). Channel 3 (bottom) shows the output of the receiver.

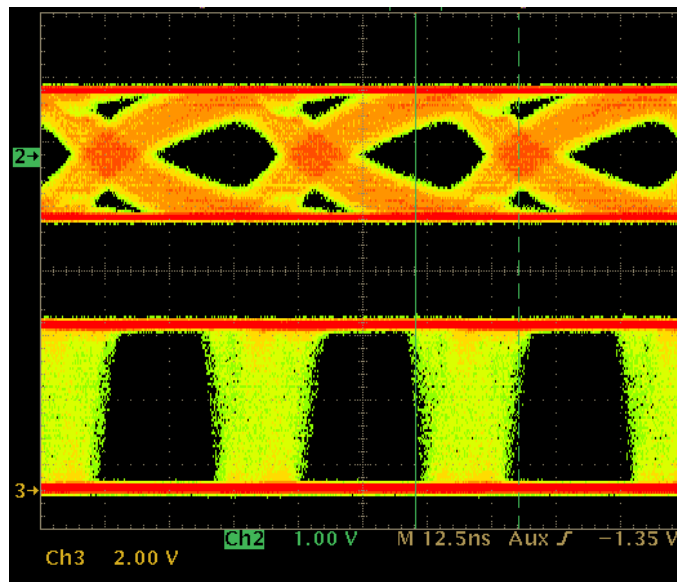
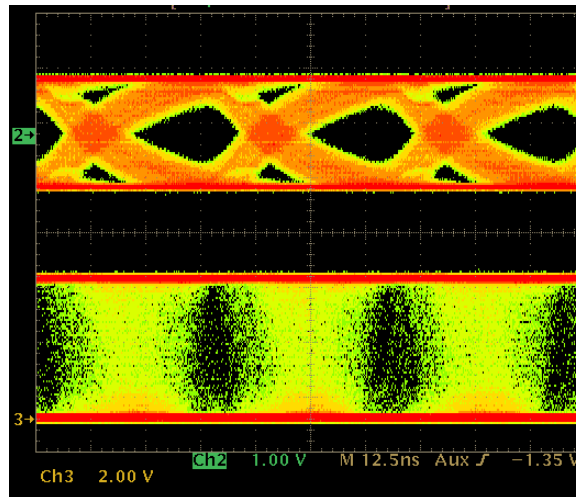
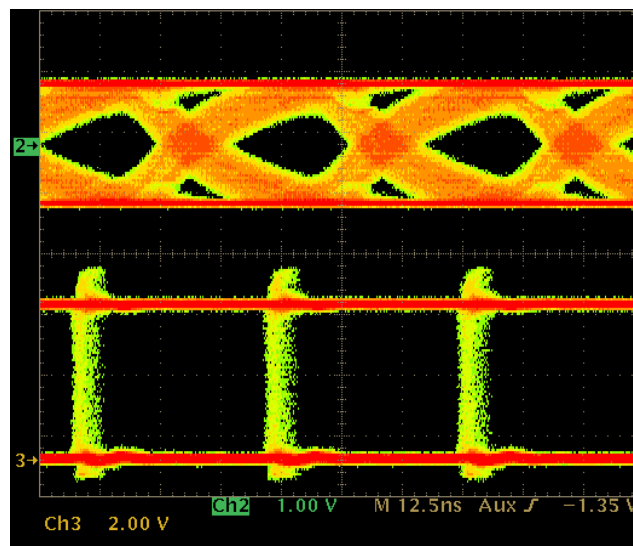


Figure 17. LTC1485, 160 m, 25 Mbps



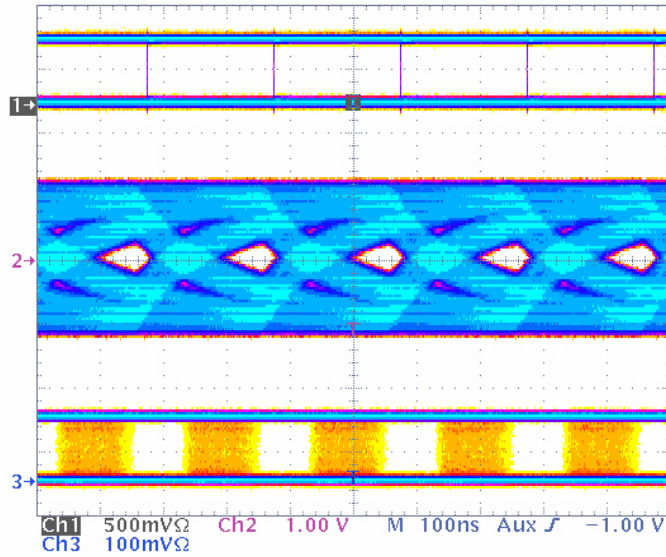
**Figure 18. MAX485, 160 m, 25 Mbps**



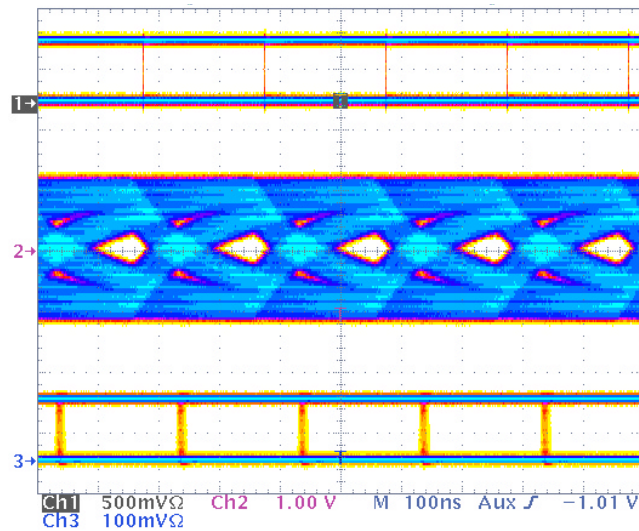
**Figure 19. SN65HVD23, 160 m, 25 Mbps**

### 5.3 Integrated Receiver Equalization Using HVD24

Figure 20 and Figure 21 illustrate the benefits of integrated receiver equalization as implemented in the SN65HVD24 transceiver. Each case compares the performance of the SN65HVD24 (with receiver equalization) to the performance of the SN65HVD21 (without receiver equalization). Other than the receiver equalization feature, these transceivers are similar. The test setup was identical for each pair of figures; a differential signal generator applied a signal voltage at one end of Belden 3105A shielded twisted-pair cable. Channel 1 (top) shows the eye-pattern of the PRBS of NRZ data. Channel 2 (middle) shows the eye pattern of the differential voltage at the receiver inputs (after the cable attenuation). Channel 3 (bottom) shows the output of the receiver.

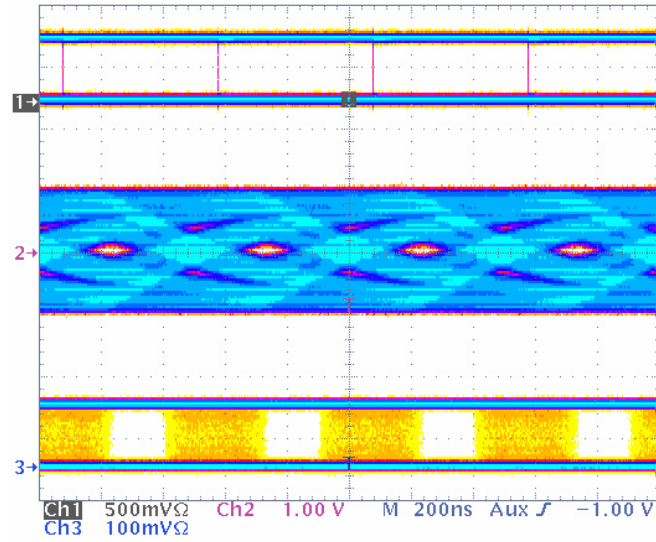


**Figure 20. SN65HVD21, 500 m, 5 Mbps**

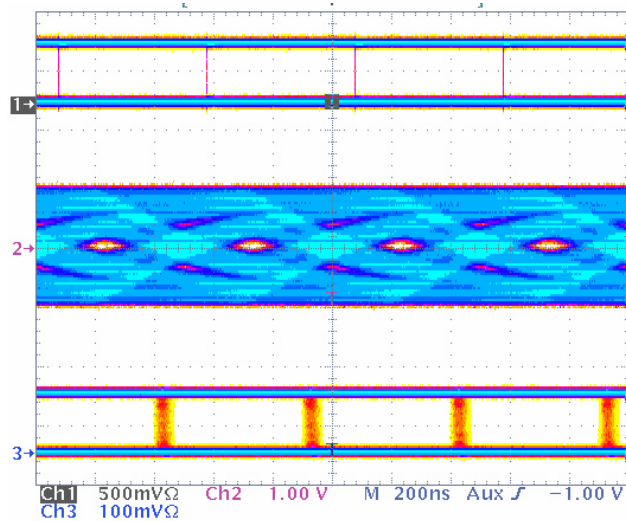


**Figure 21. SN65HVD24, 500 m, 5 Mbps**

The data in Figure 20 and Figure 21 shows how the SN65HVD24 with receiver equalization can reliably receive data at 5 Mbps across a 500-meter cable. Note that when using the SN65HVD21 (without receiver equalization), there is about 50% jitter at the receiver output. Under the same conditions, the receiver output of the SN65HVD24 has less than 10% jitter.



**Figure 22. SN65HVD21, 1000 m, 2 Mbps**



**Figure 23. SN65HVD24, 1000 m, 2 Mbps**

The data in Figure 22 and Figure 23 shows how the SN65HVD24 with receiver equalization can reliably receive data at 2 Mbps across a 1-km cable. Note that when using the SN65HVD21 (without receiver equalization) there is more than 50% jitter on the receiver output. Under the same conditions, the receiver output of the SN65HVD24 has about 10% jitter.

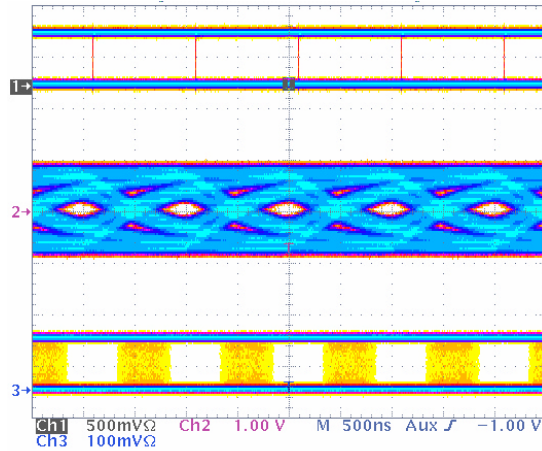


Figure 24. SN65HVD21, 1500 m, 1 Mbps

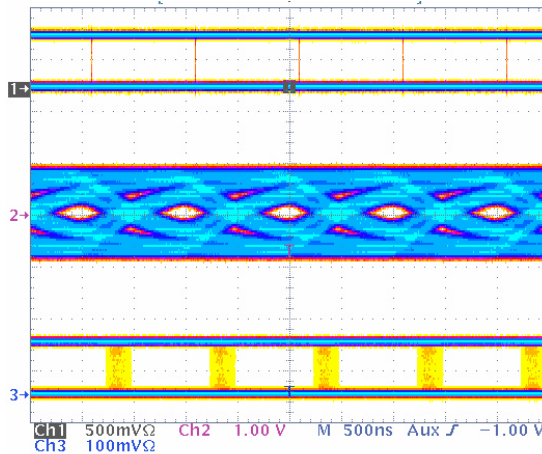


Figure 25. SN65HVD24, 1500 m, 1 Mbps

Similar to the preceding comparisons, Figure 24 and Figure 25 illustrate how the SN65HVD24 has better reception than standard receivers do over extremely long cables, in this case a 1.5-km Belden 3105A cable.

#### 5.4 Bit Error Rate (BER) Test Results

BER testing, described in section 2.4, is a measure of the overall quality of the data transmission system. To demonstrate the effect of receiver equalization, two cases were tested using transceivers with and without receiver equalization. BER testing was done using an Agilent 81250 Parallel Bit Error Rate Tester with a  $2^{15}-1$  PRBS differential signal. This testing was performed at nominal conditions of temperature and Vcc. Table 2 summarizes the results of these tests. The systems with receiver equalization were able to communicate data at significantly higher signaling rate than non-equalized transceivers with no observable errors over a 1-hour period.

**Table 2. Results of BER Testing**

Case	Highest Possible Signaling Rate With No Errors	
	Without Receiver Equalization	With Receiver Equalization
150-m cable (Belden 3105A) Fast signaling rate	41 Mbps (SN65HVD20)	73 Mbps (SN65HVD23)
500-m cable (Belden 3105A) Medium signaling rate	5 Mbps (SN65HVD21)	17 Mbps (SN65HVD24)

## 5.5 Limitations of Receiver Equalization

As with any advanced feature, there are limitations to the benefits of receiver equalization. The effectiveness of receiver equalization depends on certain factors of the data transmission system. Recovering data from attenuated signals by receiver equalization simply makes use of factors concerning the expected signal (voltage levels, signaling rate) and the communications channel (cable properties, length, and attenuation). Receiver equalization produces significant benefits only through the effective use of these factors.

One issue to consider is whether the receiver's increased sensitivity to high-frequency signals can cause response to electrical noise. To limit noise sensitivity, the receiver equalization filter should be as narrow as possible. Ideally, with perfect knowledge of the signaling rate, the filter response would match only the needed frequency band. With the SN65HVD23 and SN65HVD24, the filter response for each is relatively narrow, while still giving some degree of latitude in terms of signaling rate. This is illustrated in Figure 13, which shows the SN65HVD23 advantage over non-equalized transceivers for signaling rates above about 5 Mbps. Below this rate, equalization has little effect, and the receiver response is similar to a non-equalized receiver. Similarly, the SN65HVD24 receiver equalization is most effective for signaling rates from 1 Mbps to about 5 Mbps. Note that for signaling rates below about 1 Mbps, the advantages of any receiver equalization would only apply to long cables.

Because the equalizing filter must be limited in bandwidth, the system designer must select the proper equalization for any particular application. Typically, the signaling rate of a system is known within some pre-defined range, thereby establishing the approximate frequencies of interest.

Even within a narrow frequency range of sensitivity, receivers with equalization exhibit more sensitivity to electrical noise than non-equalized receivers do. To counter this, the SN65HVD23 and SN65HVD24 receivers have higher levels of hysteresis than typical receivers do. The hysteresis keeps the receiver from changing state in the presence of small differential noise.

The test circuit shown in Figure 26 can directly measure the receiver sensitivity across frequencies of interest. A valid bus state, in this case the worst-case minimum differential signal of -200 mV, is applied to the receiver inputs. Then, a noise input is applied, and the amplitude increased to determine the receiver threshold at each given frequency.



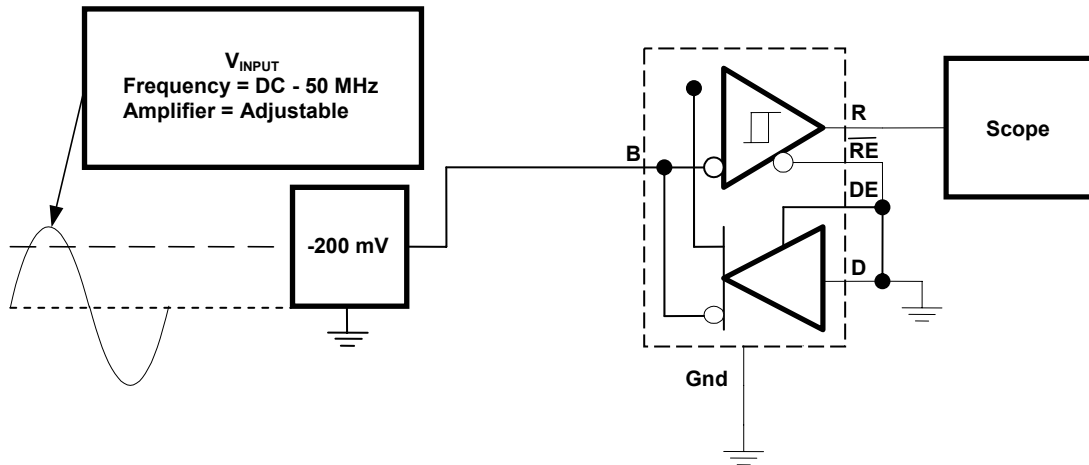


Figure 26. Sensitivity vs. Frequency Test Circuit

Figure 27 compares the SN65HVD23 equalized receiver response with the SN65HVD20 non-equalized receiver. Although the SN65HVD23 shows more sensitivity in the frequency band associated with its application signaling rate, it still maintains about 175 mV of threshold margin within the requirements of the TIA/EIA-485-A standard. This is due in part to the high level of hysteresis (> 100 mV) designed into the SN65HVD2X family of transceivers. A similar curve would apply for the SN65HVD24.

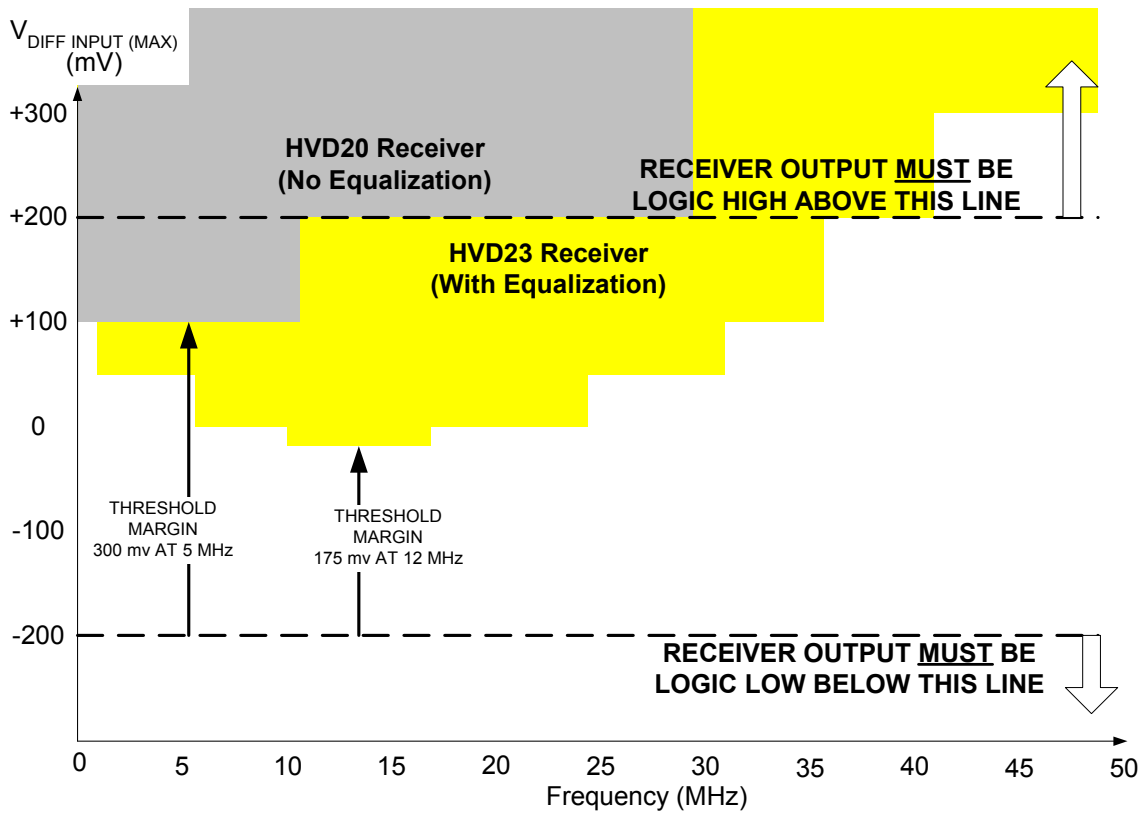
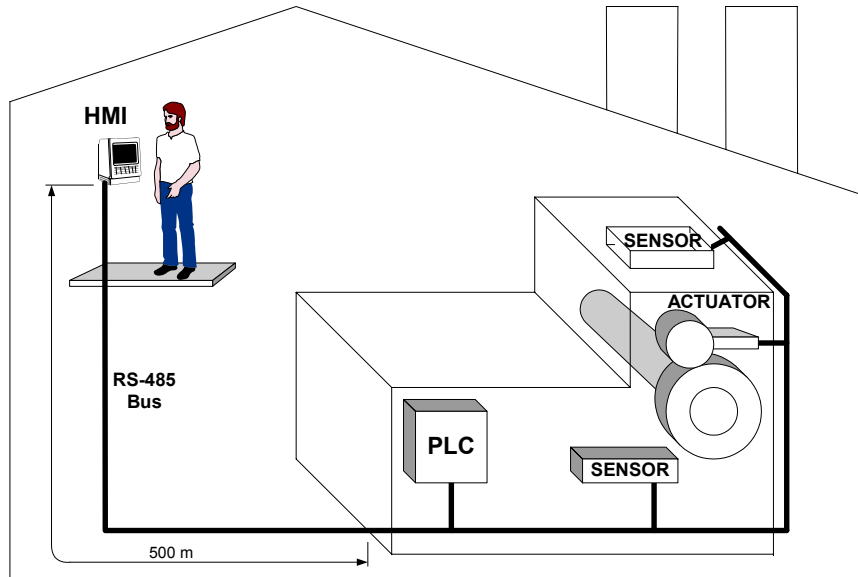


Figure 27. Comparative Sensitivity With and Without Receiver Equalization

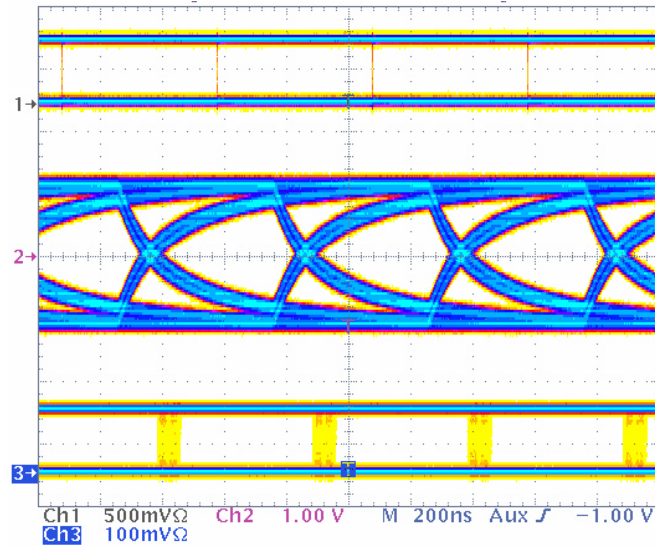
## 6 Applications

One example, which illustrates the possible application benefits of receiver equalization, is a factory automation network as shown in Figure 28. For installation in a large factory environment, end-equipment users may ask for the flexibility to install programmable logic controllers (PLCs), sensors (temperature, pressure, flow) and actuators (motors or pneumatics) up to 500 meters away from the main human/machine interface (HMI) station.

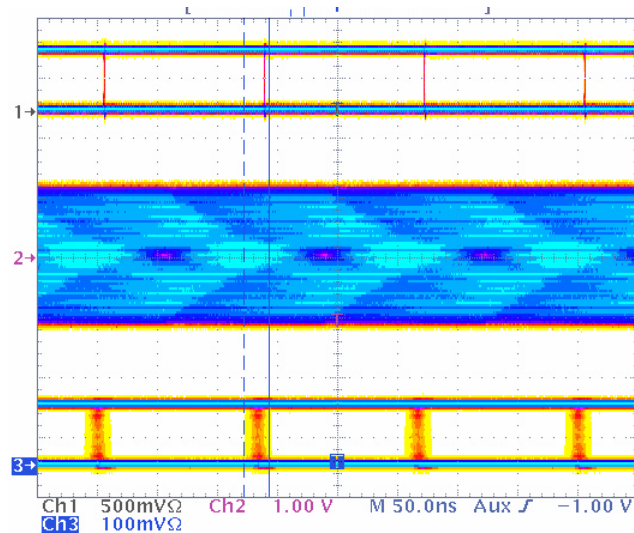


**Figure 28. Factory Automation Example**

Without receiver equalization, signaling rates may be limited to only about 2 Mbps, depending on good system design, quality of cable, etc. This is illustrated in Figure 29, where the high-frequency attenuation is evident in the differential signal (middle trace), but the receiver output signal (bottom trace) has acceptable jitter.



**Figure 29. SN65HVD21, 500-m Cable, 2 Mbps**



**Figure 30. SN65HVD24, 500-m Cable, 7.5 Mbps**

In Figure 30, an SN65HVD24 transceiver is used, and the signaling rate can be raised to 7.5 Mbps using the same cable. Note that although the differential signal is degraded, the output of the receiver has acceptable jitter, comparable to the 2-Mbps case without receiver equalization.

This significant increase in network signaling rate allows more throughput on the same installed network or can enable faster system timing for critical functions.

Another application of interest would be building automation for HVAC or security functions, where an extension of distance at standard signaling rates is beneficial. For a high-speed network running with a signaling rate of 25 Mbps, for instance, the SN65HVD23 could extend the maximum network length from about 50 meters to about 150 meters. Similarly, for a building automation network running with a signaling rate of 5 Mbps, the SN65HVD24 could extend the maximum network length from about 150 meters to about 500 meters.

Finally, in any application where cable cost reduction is a benefit, consider the advantages of receiver equalization. An example is a building automation where the existing installed cable is adequate to support up to 500-kbps signaling. Suppose the building HVAC and security electronics are to be upgraded with additional functionality for increased energy efficiency (thermostats, lighting control, etc.) and better security (motion detectors, audio sensors, badge readers). If these higher performance features are to be supported, the network may require signaling at 1 Mbps or higher. The costs associated with upgrading the cable for the higher signaling rate would include rewiring labor, downtime in all affected areas, material costs, etc. If transceivers with receiver equalization can be used to reduce this expense, the benefits would be substantial.

## 7 Conclusion

Receiver equalization can extend the usable limits on RS-485 data communications. Extension to higher signaling rates, longer cable distances, and/or more economical cable are all possible. Texas Instruments offers integrated receiver equalization in the SN65HVD23 and the SN65HVD24 with proven performance advantages.

## 8 References

1. *Suggestions for LVDS Connections* (SLLA104)
2. *Low-Voltage Differential Signaling (LVDS) Design Notes* (SLLA014)
3. *Interface Circuits for TIA/EIA-485 (RS-485)* (SLLA036)
4. *Handbook of Wiring, Cabling, and Interconnecting for Electronics*, Charles A. Harper, ed., McGraw-Hill, New York, 1972.
5. *Introduction to Copper Cabling*, John Crisp, Newnes (Elsevier Science), Oxford, 2002.
6. Belden Wire and Cable Company, [www.belden.com](http://www.belden.com)
7. CommScope, [www.commscope.com](http://www.commscope.com)
8. General Cable Corporation, [www.generalcable.com](http://www.generalcable.com)
9. Madison Cable Corporation, [www.madisoncable.com](http://www.madisoncable.com)
10. *Pre-emphasis improves RS-485 communication*, Ted Salazar and Larry Suppan, EDN Magazine, July 10, 1999.

## IMPORTANT NOTICE

Texas Instruments Incorporated and its subsidiaries (TI) reserve the right to make corrections, modifications, enhancements, improvements, and other changes to its products and services at any time and to discontinue any product or service without notice. Customers should obtain the latest relevant information before placing orders and should verify that such information is current and complete. All products are sold subject to TI's terms and conditions of sale supplied at the time of order acknowledgment.

TI warrants performance of its hardware products to the specifications applicable at the time of sale in accordance with TI's standard warranty. Testing and other quality control techniques are used to the extent TI deems necessary to support this warranty. Except where mandated by government requirements, testing of all parameters of each product is not necessarily performed.

TI assumes no liability for applications assistance or customer product design. Customers are responsible for their products and applications using TI components. To minimize the risks associated with customer products and applications, customers should provide adequate design and operating safeguards.

TI does not warrant or represent that any license, either express or implied, is granted under any TI patent right, copyright, mask work right, or other TI intellectual property right relating to any combination, machine, or process in which TI products or services are used. Information published by TI regarding third-party products or services does not constitute a license from TI to use such products or services or a warranty or endorsement thereof. Use of such information may require a license from a third party under the patents or other intellectual property of the third party, or a license from TI under the patents or other intellectual property of TI.

Reproduction of information in TI data books or data sheets is permissible only if reproduction is without alteration and is accompanied by all associated warranties, conditions, limitations, and notices. Reproduction of this information with alteration is an unfair and deceptive business practice. TI is not responsible or liable for such altered documentation.

Resale of TI products or services with statements different from or beyond the parameters stated by TI for that product or service voids all express and any implied warranties for the associated TI product or service and is an unfair and deceptive business practice. TI is not responsible or liable for any such statements.

Following are URLs where you can obtain information on other Texas Instruments products and application solutions:

<b>Products</b>		<b>Applications</b>	
Amplifiers	<a href="http://amplifier.ti.com">amplifier.ti.com</a>	Audio	<a href="http://www.ti.com/audio">www.ti.com/audio</a>
Data Converters	<a href="http://dataconverter.ti.com">dataconverter.ti.com</a>	Automotive	<a href="http://www.ti.com/automotive">www.ti.com/automotive</a>
DSP	<a href="http://dsp.ti.com">dsp.ti.com</a>	Broadband	<a href="http://www.ti.com/broadband">www.ti.com/broadband</a>
Interface	<a href="http://interface.ti.com">interface.ti.com</a>	Digital Control	<a href="http://www.ti.com/digitalcontrol">www.ti.com/digitalcontrol</a>
Logic	<a href="http://logic.ti.com">logic.ti.com</a>	Military	<a href="http://www.ti.com/military">www.ti.com/military</a>
Power Mgmt	<a href="http://power.ti.com">power.ti.com</a>	Optical Networking	<a href="http://www.ti.com/opticalnetwork">www.ti.com/opticalnetwork</a>
Microcontrollers	<a href="http://microcontroller.ti.com">microcontroller.ti.com</a>	Security	<a href="http://www.ti.com/security">www.ti.com/security</a>
		Telephony	<a href="http://www.ti.com/telephony">www.ti.com/telephony</a>
		Video & Imaging	<a href="http://www.ti.com/video">www.ti.com/video</a>
		Wireless	<a href="http://www.ti.com/wireless">www.ti.com/wireless</a>

Mailing Address: Texas Instruments  
Post Office Box 655303 Dallas, Texas 75265