

ADC11DV200 Dual 11-bit, 200 MSPS Low-Power A/D Converter with Parallel LVDS/CMOS Outputs

Check for Samples: [ADC11DV200](#)

FEATURES

- Single 1.8V Power Supply Operation.
- Power Scaling with Clock Frequency.
- Internal Sample-and-Hold.
- Internal or External Reference.
- Power Down Mode.
- Offset Binary or 2's Complement Output Data Format.
- LVDS or CMOS Output Signals.
- 60-Pin WQFN Package, (9x9x0.8mm, 0.5mm Pin-Pitch)
- Clock Duty Cycle Stabilizer.
- IF Sampling Bandwidth > 900MHz.

APPLICATIONS

- Digital Predistortion (DPD)
- Wireless Communications Infrastructure
- Medical Imaging
- Portable Instrumentation
- Digital Video

KEY SPECIFICATIONS

- Resolution: 11 Bits
- Conversion Rate: 200 MSPS
- ENOB: 10.06 bits (typ) @ $F_{in}=70$ MHz
- SNR: 62.5 dBFS (typ) @ $F_{in}=70$ MHz
- SINAD: 62.3 dBFS (typ) @ $F_{in}=70$ MHz
- SFDR: 82 dBFS (typ) @ $F_{in}=70$ MHz
- LVDS: Power 450 mW (typ) @ $F_s=200$ MSPS
- CMOS: Power 280 mW (typ) @ $F_s=170$ MSPS
- Operating Temp. Range: -40°C to $+85^{\circ}\text{C}$.

DESCRIPTION

The ADC11DV200 is a monolithic analog-to-digital converter capable of converting two analog input signals into 11-bit digital words at rates up to 200 Mega Samples Per Second (MSPS). The digital output mode is selectable and can be either differential LVDS or CMOS signals. This converter uses a differential, pipelined architecture with digital error correction and an on-chip sample-and-hold circuit to minimize die size and power consumption while providing excellent dynamic performance. A unique sample-and-hold stage yields a full-power bandwidth of 900MHz. Fabricated in core CMOS process, the ADC11DV200 may be operated from a single 1.8V power supply. The ADC11DV200 achieves approximately 10.06 effective bits at Nyquist and consumes just 280mW at 170MSPS in CMOS mode 450mW at 200MSPS in LVDS mode. The power consumption can be scaled down further by reducing sampling rates.



Please be aware that an important notice concerning availability, standard warranty, and use in critical applications of Texas Instruments semiconductor products and disclaimers thereto appears at the end of this data sheet.

All trademarks are the property of their respective owners.

Block Diagram

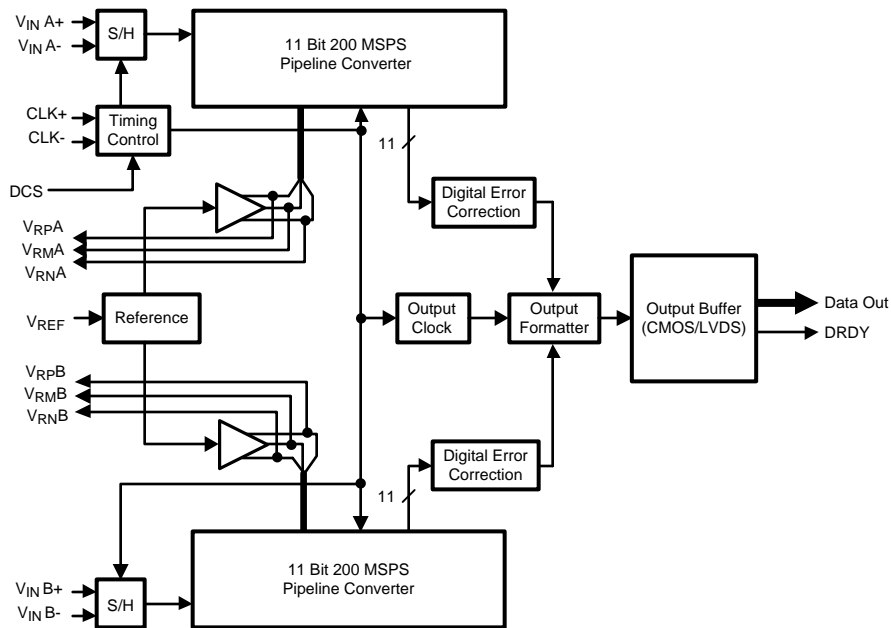

Connection Diagram

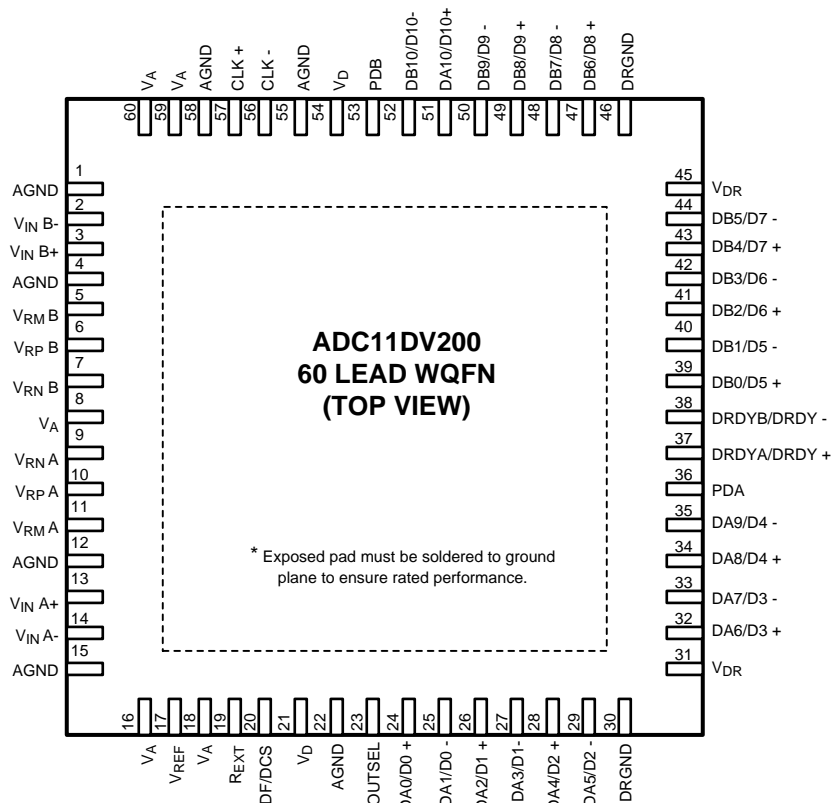

Pin Descriptions and Equivalent Circuits

Pin No.	Symbol	Equivalent Circuit	Description	
ANALOG I/O				
13 3	$V_{IN A+}$ $V_{IN B+}$		<p>Differential analog input pins. The differential full-scale input signal level is $1.5V_{P,P}$ with each input pin signal centered on a common mode voltage, V_{CM}.</p>	
14 2	$V_{IN A-}$ $V_{IN B-}$			
10 6	$V_{RP A}$ $V_{RP B}$		<p>These pins should each be bypassed to AGND with a low ESL (equivalent series inductance) 0.1 μF capacitor placed very close to the pin to minimize stray inductance. An 0201 size 0.1 μF capacitor should be placed between V_{RP} and V_{RN} as close to the pins as possible.</p> <p>V_{RP} and V_{RN} should not be loaded. V_{RM} may be loaded to 1mA for use as a temperature stable 0.9V reference.</p> <p>It is recommended to use V_{RM} to provide the common mode voltage, V_{CM} for the differential analog inputs.</p>	
11 5	$V_{RM A}$ $V_{RM B}$			
9 7	$V_{RN A}$ $V_{RN B}$			
17	V_{REF}		<p>Reference Voltage select pin and external reference input. The relationship between the voltage on the pin and the reference voltage is as follows:</p>	
			<p>$1.4V \leq V_{REF} \leq V_A$</p>	<p>The internal 0.75V reference is used.</p>
			<p>$0.2V \leq V_{REF} \leq 1.4V$</p>	<p>The external reference voltage is used. Note: When using an external reference, be sure to bypass with a 0.1μF capacitor to AGND as close to the pin as possible.</p>
			<p>$AGND \leq V_{REF} \leq 0.2V$</p> <p>The internal 0.5V reference is used.</p>	
19	R_{EXT}		<p>Programming resistor for analog bias current. Nominally a 3.3kΩ to AGND for 200MSPS, or tie to V_A to use the internal frequency scaling current.</p>	

Pin Descriptions and Equivalent Circuits (continued)

Pin No.	Symbol	Equivalent Circuit	Description
20	DF/DCS		Data Format/Duty Cycle Correction selection pin. (see Table 1)
DIGITAL I/O			
57 56	CLK + CLK -		Clock input pins signal. The analog inputs are sampled on the rising edge of this signal. The clock can be configured for single-ended mode by shorting the CLK- pin to AGND. When in differential mode, the common mode voltage for the clock is internally set to 1.2V.
36 53	PD_A PD_B		Two-state input controlling Power Down. PD = V _A , Power Down is enabled and power dissipation is reduced. PD = AGND, Normal operation.
23	OUTSEL		Two-state input controlling Output Mode. OUTSEL = V _D , LVDS Output Mode. OUTSEL = AGND, CMOS Output Mode.
LVDS Output Mode			
24, 25 26, 27 28, 29 32, 33 34, 35 39, 40 41, 42 43, 44 47, 48 49, 50 51, 52	D0+, D0- D1+, D1- D2+, D2- D3+, D3- D4+, D4- D5+, D5- D6+, D6- D7+, D7- D8+, D8- D9+, D9- D10+, D10-		LVDS Output pairs for bits 0 through 10. A-channel and B-channel digital LVDS outputs are interleaved. A channel is ready at rising edge of DRDY and B channel is ready at the falling edge of DRDY.
37 38	DRDY+ DRDY-		Data Ready Strobe. This signal is a LVDS DDR clock used to capture the output data. A-channel data is valid on the rising edge of this signal and B-channel data is valid on the falling edge.

Pin Descriptions and Equivalent Circuits (continued)

Pin No.	Symbol	Equivalent Circuit	Description
CMOS Output Mode			
24-29, 32-35,51	DA0-DA10		Digital data output pins that make up the 11-bit conversion result for Channel A. DA0 (pin 24) is the LSB, while DA10 (pin 51) is the MSB of the output word. Output levels are CMOS compatible.
39-44, 47-50,52	DB0-DB10		Digital data output pins that make up the 11-bit conversion result for Channel B. DB0 (pin 39) is the LSB, while DB10 (pin 52) is the MSB of the output word. Output levels are CMOS compatible.
37	DRDYA		Data Ready Strobe for channel A. This signal is used to clock the A-Channel output data. DRDYA is a SDR clock with same frequency as CLK rate and data is valid on the rising edges.
38	DRDYB		Data Ready Strobe for channel B. This signal is used to clock the B-Channel output data. DRDYB is a SDR clock with same frequency as CLK rate and data is valid on the rising edges.
ANALOG POWER			
8, 16, 18, 59, 60	VA		Positive analog supply pins. These pins should be connected to a quiet source and be bypassed to AGND with 0.1 μF capacitors located close to the power pins.
1, 4, 12, 15, 22, 55, 58, EP	AGND		The ground return for the analog supply. Exposed Pad (EP) must be soldered to AGND to ensure rated performance.
DIGITAL POWER			
21, 54	VD		Positive digital supply pins. These pins should be connected to a quiet source and be bypassed to AGND with 0.1 μF capacitors located close to the power pins.
31, 45	VDR		Positive driver supply pin for the output drivers. This pin should be connected to a quiet voltage source and be bypassed to DRGND with a 0.1 μF capacitor located close to the power pin.
30, 46	DRGND		The ground return for the digital output driver supply. This pin should be connected to the system digital ground.

Table 1. Voltage on DF/DCS Pin and Corresponding Chip Response

Voltage on DF/DCS		Results		Suggestions
Min	Max	DF	DCS	
0 mV	200mV	1	1	2's complement data, duty cycle correction on Tie to AGND
250 mV	600 mV	0	0	Offset binary data, duty cycle correction off Leave floating
750 mV	1250 mV	1	0	2's complement data, duty cycle correction off
1400mV	VA	0	1	Offset binary data, duty cycle correction on Tie to VA



These devices have limited built-in ESD protection. The leads should be shorted together or the device placed in conductive foam during storage or handling to prevent electrostatic damage to the MOS gates.

Absolute Maximum Ratings⁽¹⁾⁽²⁾⁽³⁾

Supply Voltage (V_A , V_D , V_{DR})		-0.3V to 2.2V
Voltage on Any Pin (Not to exceed 2.2V)		-0.3V to ($V_A + 0.3V$)
Input Current at Any Pin other than Supply Pins ⁽⁴⁾		± 25 mA
Package Input Current ⁽⁴⁾		± 50 mA
Max Junction Temp (T_J)		+150°C
Thermal Resistance (θ_{JA}) ⁽⁵⁾		30°C/W
ESD Rating ⁽⁶⁾	Human Body Model	2500V
	Machine Model	250V
	Human Body Model	750V
Storage Temperature		-65°C to +150°C
<i>Soldering process must comply with TI's Reflow Temperature Profile specifications. Refer to www.ti.com/packageing.⁽⁷⁾</i>		

- (1) Absolute Maximum Ratings indicate limits beyond which damage to the device may occur. Operating Ratings indicate conditions for which the device is specified to be functional, but do not ensure specific performance limits. For ensured specifications and test conditions, see the Electrical Characteristics. The ensured specifications apply only for the test conditions listed. Some performance characteristics may degrade when the device is not operated under the listed test conditions. Operation of the device beyond the maximum Operating Ratings is not recommended.
- (2) All voltages are measured with respect to GND = AGND = DRGND = 0V, unless otherwise specified.
- (3) If Military/Aerospace specified devices are required, please contact the TI Sales Office/Distributors for availability and specifications.
- (4) When the input voltage at any pin exceeds the power supplies (that is, $V_{IN} < AGND$, or $V_{IN} > V_A$), the current at that pin should be limited to ± 5 mA. The ± 50 mA maximum package input current rating limits the number of pins that can safely exceed the power supplies with an input current of ± 5 mA to 10.
- (5) The maximum allowable power dissipation is dictated by $T_{J,max}$, the junction-to-ambient thermal resistance, (θ_{JA}), and the ambient temperature, (T_A), and can be calculated using the formula $P_{D,max} = (T_{J,max} - T_A) / \theta_{JA}$. The values for maximum power dissipation listed above will be reached only when the device is operated in a severe fault condition (e.g. when input or output pins are driven beyond the power supply voltages, or the power supply polarity is reversed). Such conditions should always be avoided.
- (6) Human Body Model is 100 pF discharged through a 1.5 k Ω resistor. Machine Model is 220 pF discharged through 0 Ω resistor. Charged device model simulates a pin slowly acquiring charge (such as from a device sliding down the feeder in an automated assembler) then rapidly being discharged.
- (7) Reflow temperature profiles are different for lead-free and non-lead-free packages.

Operating Ratings⁽¹⁾⁽²⁾

Operating Temperature		$-40^\circ\text{C} \leq T_A \leq +85^\circ\text{C}$
Supply Voltage (V_A , V_D , V_{DR})		+1.7V to +1.9V
Clock Duty Cycle	(DCS Enabled)	30/70 %
	(DCS disabled)	48/52 %
V_{CM}		0.8V to 1.0V

- (1) Absolute Maximum Ratings indicate limits beyond which damage to the device may occur. Operating Ratings indicate conditions for which the device is specified to be functional, but do not ensure specific performance limits. For ensured specifications and test conditions, see the Electrical Characteristics. The ensured specifications apply only for the test conditions listed. Some performance characteristics may degrade when the device is not operated under the listed test conditions. Operation of the device beyond the maximum Operating Ratings is not recommended.
- (2) All voltages are measured with respect to GND = AGND = DRGND = 0V, unless otherwise specified.

Converter Electrical Characteristics

Unless otherwise specified, the following specifications apply: AGND = DRGND = 0V, $V_A = V_D = V_{DR} = +1.8V$, $f_{CLK} = 200$ MHz, CLK duty cycle = 50%, DCS = ON, Internal 0.75V Reference, LVDS Output. Typical values are for $T_A = 25^\circ C$. **Boldface limits apply for $T_{MIN} \leq T_A \leq T_{MAX}$.** All other limits apply for $T_A = +25^\circ C$ ^{(1) (2)}

Symbol	Parameter	Conditions	Typical ⁽³⁾	Limits	Units (Limits)
STATIC CONVERTER CHARACTERISTICS					
	Resolution with No Missing Codes			11	Bits (min)
INL	Integral Non Linearity		0.65	1.5 -1.5	LSB (max) LSB (min)
DNL	Differential Non Linearity		0.32	0.75 -0.65	LSB (max) LSB (min)
PGE	Positive Gain Error		0.57	±3	%FS (max)
NGE	Negative Gain Error		0.60	±2.7	%FS (max)
TC PGE	Positive Gain Error Tempco	$-40^\circ C \leq T_A \leq +85^\circ C$	13		ppm/°C
TC NGE	Negative Gain Error Tempco	$-40^\circ C \leq T_A \leq +85^\circ C$	15		ppm/°C
V_{OFF}	Offset Error		0.1	±0.55	%FS (max)
TC V_{OFF}	Offset Error Tempco	$-40^\circ C \leq T_A \leq +85^\circ C$	4		ppm/°C
	Under Range Output Code		0	0	
	Over Range Output Code		2047	2047	
REFERENCE AND ANALOG INPUT CHARACTERISTICS					
V_{RM}	Common Mode Output Voltage		0.9	1 0.85	V (min) V (max)
V_{CM}	Analog Input Common Mode Voltage		0.9		V
C_{IN}	V_{IN} Input Capacitance (each pin to AGND) ⁽⁴⁾	$V_{IN} = 0.75$ Vdc ± 0.5 V	(CLK LOW)	1	pF
			(CLK HIGH)	2.5	pF
V_{RP}	Internal Reference Top		1.33		V
V_{RN}	Internal Reference Bottom		0.55		V
	Internal Reference Accuracy	$(V_{RP} - V_{RN})$	0.78		V
EXT V_{REF}	External Reference Voltage			0.5 1.0	V (Min) V (max)

- (1) The inputs are protected as shown below. Input voltage magnitudes above V_A or below GND will not damage this device, provided current is limited per [Absolute Maximum Ratings, Note 4](#). However, errors in the A/D conversion can occur if the input goes above V_A or below AGND.

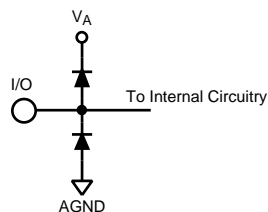

- (2) With a full scale differential input of $1.5V_{P-P}$, the 11-bit LSB is $732.8\mu V$.
- (3) Typical figures are at $T_A = 25^\circ C$ and represent most likely parametric norms at the time of product characterization. The typical specifications are not ensured.
- (4) The input capacitance is the sum of the package/pin capacitance and the sample and hold circuit capacitance.

Dynamic Converter Electrical Characteristics

Unless otherwise specified, the following specifications apply: AGND = DRGND = 0V, $V_A = V_D = V_{DR} = +1.8V$, $f_{CLK} = 200$ MHz, CLK duty cycle = 50%, DCS = ON, Internal 0.75V Reference, LVDS Output. Typical values are for $T_A = 25^\circ C$. **Boldface limits apply for $T_{MIN} \leq T_A \leq T_{MAX}$.** All other limits apply for $T_A = +25^\circ C$ ^{(1) (2)}

Symbol	Parameter	Conditions	Typical ⁽³⁾	Limits	Units (Limits) ⁽⁴⁾
DYNAMIC CONVERTER CHARACTERISTICS, $A_{IN} = -1dBFS$					
FPBW	Full Power Bandwidth ⁽⁵⁾	-1 dBFS Input, -3 dB Corner	900		MHz
SNR	Signal-to-Noise Ratio ⁽⁶⁾	$f_{IN} = 10$ MHz, $V_{ref} = 0.75V$	62.5		dBFS
		$f_{IN} = 10$ MHz, $V_{ref} = 1.0V$	63.8		dBFS
		$f_{IN} = 70$ MHz, $V_{ref} = 0.75V$	62.5	61.5	dBFS (min)
		$f_{IN} = 70$ MHz, $V_{ref} = 1.0V$	63.7		dBFS
SFDR	Spurious Free Dynamic Range ⁽⁷⁾	$f_{IN} = 10$ MHz, $V_{ref} = 0.75V$	82		dBFS
		$f_{IN} = 10$ MHz, $V_{ref} = 1.0V$	82.4		dBFS
		$f_{IN} = 70$ MHz, $V_{ref} = 0.75V$	82	71.5	dBFS (min)
		$f_{IN} = 70$ MHz, $V_{ref} = 1.0V$	81.8		dBFS
ENOB	Effective Number of Bits	$f_{IN} = 10$ MHz	10.06		Bits
		$f_{IN} = 70$ MHz	10.06	9.84	Bits (min)
H2	Second Harmonic Distortion	$f_{IN} = 10$ MHz	-94		dBFS
		$f_{IN} = 70$ MHz	-94	-71.5	dBFS (min)
H3	Third Harmonic Distortion	$f_{IN} = 10$ MHz	-85		dBFS
		$f_{IN} = 70$ MHz	-84	-71.5	dBFS (min)
SINAD	Signal-to-Noise and Distortion Ratio ⁽⁸⁾	$f_{IN} = 10$ MHz	62.3		dBFS
		$f_{IN} = 70$ MHz	62.3	61	dBFS (min)
IMD	Intermodulation Distortion ⁽⁹⁾	$f_{IN1} = 69$ MHz $A_{IN1} = -7$ dBFS	93		dBFS
		$f_{IN2} = 70$ MHz $A_{IN2} = -7$ dBFS			
	Cross Talk ⁽⁹⁾	$f_{IN1} = 69$ MHz $A_{IN1} = -1$ dBFS	97		dBFS
		$f_{IN2} = 70$ MHz $A_{IN2} = -1$ dBFS			

- (1) The inputs are protected as shown below. Input voltage magnitudes above V_A or below GND will not damage this device, provided current is limited per [Absolute Maximum Ratings, Note 4](#). However, errors in the A/D conversion can occur if the input goes above V_A or below AGND.

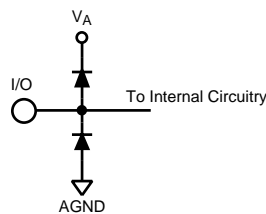

- (2) With a full scale differential input of $1.5V_{P,P}$, the 11-bit LSB is $732.8\mu V$.
- (3) Typical figures are at $T_A = 25^\circ C$ and represent most likely parametric norms at the time of product characterization. The typical specifications are not ensured.
- (4) Units of dBFS indicates the value that would be attained with a full-scale input signal.
- (5) This parameter is specified by design and/or characterization and is not tested in production.
- (6) SNR minimum and typical values are for LVDS mode. Typical values for CMOS mode are typically 0.2dBFS lower.
- (7) SFDR minimum and typical values are for LVDS mode. Typical values for CMOS mode are typically 2dBFS lower.
- (8) SINAD minimum and typical values are for LVDS mode. Typical values for CMOS mode are typically 0.1dBFS lower.
- (9) This parameter is specified by design and/or characterization and is not tested in production.

Power Supply Electrical Characteristics

Unless otherwise specified, the following specifications apply: AGND = DRGND = 0V, $V_A = V_D = V_{DR} = +1.8V$, $f_{CLK} = 200$ MHz, CLK duty cycle = 50%, DCS = ON, Internal 0.75V Reference, LVDS Output. Typical values are for $T_A = 25^\circ C$. **Boldface limits apply for $T_{MIN} \leq T_A \leq T_{MAX}$.** All other limits apply for $T_A = 25^\circ C$ ⁽¹⁾⁽²⁾

Symbol	Parameter	Conditions	Typical (3)	Limits	Units (Limits)
LVDS OUTPUT MODE					
I_A	Analog Supply Current	Full Operation, Internal Bias	160		mA
		Full Operation, External 3.3kΩ Bias	148	168	mA (max)
I_D	Digital Supply Current	Full Operation	36	41	mA (max)
I_{DR}	Output Driver Supply Current		64	83	mA (max)
	Power Consumption	Internal Bias	473		mW
		External 3.3kΩ Bias	450	525	mW (max)
	Power Down Power Consumption	PDA=PDB= V_A	57		mW
CMOS OUTPUT MODE ⁽⁴⁾					
I_A	Analog Supply Current	Full Operation, Internal Bias	138		mA
		Full Operation, External 3.3kΩ Bias	124		
I_D	Digital Supply Current	Full Operation	31		mA
	Power Consumption	Internal Bias	310		mW
		External 3.3kΩ Bias	280		
	Power Down Power Consumption	PDA=PDB= V_A	60		mW

- (1) The inputs are protected as shown below. Input voltage magnitudes above V_A or below GND will not damage this device, provided current is limited per [Absolute Maximum Ratings, Note 4](#). However, errors in the A/D conversion can occur if the input goes above V_A or below AGND.

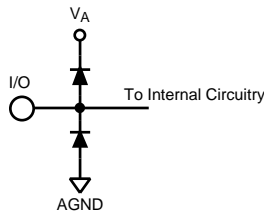

- (2) With a full scale differential input of $1.5V_{P-P}$, the 11-bit LSB is $732.8\mu V$.
- (3) Typical figures are at $T_A = 25^\circ C$ and represent most likely parametric norms at the time of product characterization. The typical specifications are not ensured.
- (4) CMOS Specifications are for $F_{CLK} = 170$ MHz.

Input/Output Logic Electrical Characteristics

Unless otherwise specified, the following specifications apply: AGND = DRGND = 0V, $V_A = V_D = V_{DR} = +1.8V$, $f_{CLK} = 200$ MHz, CLK duty cycle = 50%, DCS = ON, Internal 0.75V Reference. Typical values are for $T_A = 25^\circ C$. **Boldface limits apply for $T_{MIN} \leq T_A \leq T_{MAX}$.** All other limits apply for $T_A = 25^\circ C$ ⁽¹⁾⁽²⁾

Symbol	Parameter	Conditions	Typical (3)	Limits	Units (Limits)
DIGITAL INPUT CHARACTERISTICS (PD_A,PD_B)					
$V_{IN(1)}$	Logical "1" Input Voltage ⁽⁴⁾	$V_A = 1.9V$		0.89	V (min)
$V_{IN(0)}$	Logical "0" Input Voltage ⁽⁴⁾	$V_A = 1.7V$		0.67	V (max)
$I_{IN(1)}$	Logical "1" Input Current	$V_{IN} = 1.8V$	10.6		μA
$I_{IN(0)}$	Logical "0" Input Current	$V_{IN} = 0V$	-7.6		μA
C_{IN}	Digital Input Capacitance		2		pF
LVDS OUTPUT CHARACTERISTICS (D0-D10,DRDY)					
V_{OD}	LVDS differential output voltage	⁽⁴⁾	330		mV _{P-P}
$\pm V_{OD}$	Output Differential Voltage Unbalance		0	50	mV
V_{OS}	LVDS common-mode output voltage	⁽⁴⁾	1.25		V
$\pm V_{OS}$	Offset Voltage Unbalance			50	mV
R_L	Intended Load Resistance		100		Ω
CMOS OUTPUT CHARACTERISTICS (DA0-DA10,DB0-DB10,DRDYA, DRDYB) ⁽⁵⁾					
V_{OH}	Logical "1" Output Voltage	$V_{DR} = 1.8V$ (Unloaded)	1.8		V
V_{OL}	Logical "0" Output Voltage	$V_{DR} = 1.8V$ (Unloaded)	0		V
$+I_{OSC}$	Output Short Circuit Source Current	$V_{OUT} = 0V$	-20		mA
$-I_{OSC}$	Output Short Circuit Sink Current	$V_{OUT} = V_{DR}$	20		mA
C_{OUT}	Digital Output Capacitance		2		pF

(1) The inputs are protected as shown below. Input voltage magnitudes above V_A or below GND will not damage this device, provided current is limited per [Absolute Maximum Ratings, Note 4](#). However, errors in the A/D conversion can occur if the input goes above V_A or below AGND.

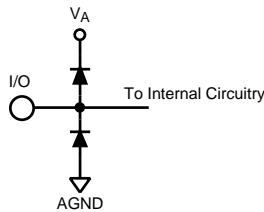

- (2) With a full scale differential input of $1.5V_{P-P}$, the 11-bit LSB is $732.8\mu V$.
- (3) Typical figures are at $T_A = 25^\circ C$ and represent most likely parametric norms at the time of product characterization. The typical specifications are not ensured.
- (4) This parameter is specified by design and/or characterization and is not tested in production.
- (5) CMOS Specifications are for $F_{CLK} = 170$ MHz.

Timing and AC Characteristics

Unless otherwise specified, the following specifications apply: AGND = DRGND = 0V, $V_A = V_D = V_{DR} = +1.8V$, $f_{CLK} = 200$ MHz, CLK duty cycle = 50%, DCS = ON, Internal 0.75V Reference. Typical values are for $T_A = 25^\circ C$. Timing measurements are taken at 50% of the signal amplitude. **Boldface limits apply for $T_{MIN} \leq T_A \leq T_{MAX}$.** All other limits apply for $T_A = 25^\circ C$ ⁽¹⁾
(2)

Symbol	Parameter	Conditions	Typical ⁽³⁾	Limits	Units (Limits)
LVDS OUTPUT MODE					
	Maximum Clock Frequency			200	MHz (max)
	Minimum Clock Frequency	DCS On DCS Off		65 45	MHz (min)
t_{CH}	Clock High Time	DCS On DCS Off		1.5 2.4	ns (min)
t_{CL}	Clock Low Time	DCS On DCS Off		1.5 2.4	ns (min)
t_{CONV}	Conversion Latency			5/5.5 (A/B)	Clock Cycles
t_{ODA}	Output Delay of CLK to A-Channel Data	Relative to rising edge of CLK	2.7	1.46	ns (min)
t_{ODB}	Output Delay of CLK to B-Channel Data	Relative to falling edge of CLK	2.7	1.46	ns (min)
t_{SU}	Data Output Setup Time	Relative to DRDY	1.2	0.7	ns (min)
t_H	Data Output Hold Time	Relative to DRDY	1.2	0.7	ns (min)
t_{AD}	Aperture Delay		0.7		ns
t_{AJ}	Aperture Jitter		0.3		ps rms
t_{SKEW}	Data-Data Skew		20	470	ps
CMOS OUTPUT MODE ⁽⁴⁾					
	Maximum Clock Frequency			170	MHz
	Minimum Clock Frequency	DCS On DCS Off		65 25	MHz
t_{CH}	Clock High Time	DCS On DCS Off		1.76 2.82	ns
t_{CL}		DCS On DCS Off		1.76 2.82	ns
t_{CONV}	Conversion Latency			5.5	Clock Cycles
t_{OD}	Output Delay of CLK to DATA	Relative to falling edge of CLK	4.5	3.15 5.81	ns (min) ns (max)
t_{SU}	Data Output Setup Time	Relative to DRDY	2.5	1.79	ns (min)
t_H	Data Output Hold Time	Relative to DRDY	3.4	2.69	ns (min)
t_{AD}	Aperture Delay		0.7		ns
t_{AJ}	Aperture Jitter		0.3		ps rms

- (1) The inputs are protected as shown below. Input voltage magnitudes above V_A or below GND will not damage this device, provided current is limited per [Absolute Maximum Ratings, Note 4](#). However, errors in the A/D conversion can occur if the input goes above V_A or below AGND.

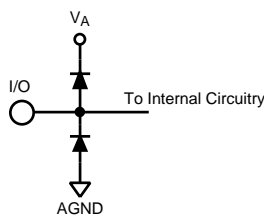

- (2) With a full scale differential input of $1.5V_{p-p}$, the 11-bit LSB is $732.8\mu V$.
 (3) Typical figures are at $T_A = 25^\circ C$ and represent most likely parametric norms at the time of product characterization. The typical specifications are not ensured.
 (4) CMOS Specifications are for $F_{CLK} = 170$ MHz.

Specification Definitions

APERTURE DELAY is the time after the falling edge of the clock to when the input signal is acquired or held for conversion.

APERTURE JITTER (APERTURE UNCERTAINTY) is the variation in aperture delay from sample to sample. Aperture jitter manifests itself as noise in the output. The amount of SNR reduction can be calculated as

$$\text{SNR Reduction} = 20 \times \log_{10}[\frac{1}{2} \times \pi \times f_A \times t_j] \quad (1)$$

CLOCK DUTY CYCLE is the ratio of the time during one cycle that a repetitive digital waveform is high to the total time of one period. The specification here refers to the ADC clock input signal.

COMMON MODE VOLTAGE (V_{CM}) is the common DC voltage applied to both input terminals of the ADC.

CONVERSION LATENCY is the number of clock cycles between initiation of conversion and when that data is presented to the output driver stage. Data for any given sample is available at the output pins the Pipeline Delay plus the Output Delay after the sample is taken. New data is available at every clock cycle, but the data lags the conversion by the pipeline delay.

CROSSTALK is coupling of energy from one channel into the other channel.

DIFFERENTIAL NON-LINEARITY (DNL) is the measure of the maximum deviation from the ideal step size of 1 LSB.

EFFECTIVE NUMBER OF BITS (ENOB, or EFFECTIVE BITS) is another method of specifying Signal-to-Noise and Distortion Ratio or SINAD. ENOB is defined as $(\text{SINAD} - 1.76) / 6.02$ and says that the converter is equivalent to a perfect ADC of this (ENOB) number of bits.

FULL POWER BANDWIDTH is a measure of the frequency at which the reconstructed output fundamental drops 3 dB below its low frequency value for a full scale input.

GAIN ERROR is the deviation from the ideal slope of the transfer function. It can be calculated as:

$$\text{Gain Error} = \text{Positive Full Scale Error} - \text{Negative Full Scale Error} \quad (2)$$

It can also be expressed as Positive Gain Error and Negative Gain Error, which are calculated as:

$$\text{PGE} = \text{Positive Full Scale Error} - \text{Offset Error} \quad \text{NGE} = \text{Offset Error} - \text{Negative Full Scale Error} \quad (3)$$

INTEGRAL NON LINEARITY (INL) is a measure of the deviation of each individual code from a best fit straight line. The deviation of any given code from this straight line is measured from the center of that code value.

INTERMODULATION DISTORTION (IMD) is the creation of additional spectral components as a result of two sinusoidal frequencies being applied to the ADC input at the same time. It is defined as the ratio of the power in the intermodulation products to the total power in the original frequencies. IMD is usually expressed in dBFS.

LSB (LEAST SIGNIFICANT BIT) is the bit that has the smallest value or weight of all bits. This value is $V_{FS}/2^n$, where " V_{FS} " is the full scale input voltage and "n" is the ADC resolution in bits.

MISSING CODES are those output codes that will never appear at the ADC outputs. The ADC is ensured not to have any missing codes.

MSB (MOST SIGNIFICANT BIT) is the bit that has the largest value or weight. Its value is one half of full scale.

NEGATIVE FULL SCALE ERROR is the difference between the actual first code transition and its ideal value of $\frac{1}{2}$ LSB above negative full scale.

OFFSET ERROR is the difference between the two input voltages $[(V_{IN+}) - (V_{IN-})]$ required to cause a transition from code 2047 to 2048.

OUTPUT DELAY is the time delay after the falling edge of the clock before the data update is presented at the output pins.

PIPELINE DELAY (LATENCY) See CONVERSION LATENCY.

POSITIVE FULL SCALE ERROR is the difference between the actual last code transition and its ideal value of $1\frac{1}{2}$ LSB below positive full scale.

POWER SUPPLY REJECTION RATIO (PSRR) is a measure of how well the ADC rejects a change in the power supply voltage. PSRR is the ratio of the Full-Scale output of the ADC with the supply at the minimum DC supply limit to the Full-Scale output of the ADC with the supply at the maximum DC supply limit, expressed in dB.

SIGNAL TO NOISE RATIO (SNR) is the ratio, expressed in dB, of the rms value of the input signal to the rms value of the sum of all other spectral components below one-half the sampling frequency, not including harmonics or DC.

SIGNAL TO NOISE PLUS DISTORTION (S/N+D or SINAD) Is the ratio, expressed in dB, of the rms value of the input signal to the rms value of all of the other spectral components below half the clock frequency, including harmonics but excluding d.c.

SPURIOUS FREE DYNAMIC RANGE (SFDR) is the difference, expressed in dB, between the rms values of the input signal and the peak spurious signal, where a spurious signal is any signal present in the output spectrum that is not present at the input.

TOTAL HARMONIC DISTORTION (THD) is the ratio, expressed in dB, of the rms total of the first six harmonic levels at the output to the level of the fundamental at the output. THD is calculated as

$$THD = 20 \times \log \sqrt{\frac{f_2^2 + \dots + f_7^2}{f_1^2}} \quad (4)$$

where f_1 is the RMS power of the fundamental (output) frequency and f_2 through f_7 are the RMS power of the first six harmonic frequencies in the output spectrum.

SECOND HARMONIC DISTORTION (2ND HARM) is the difference expressed in dB, between the RMS power in the input frequency at the output and the power in its 2nd harmonic level at the output.

THIRD HARMONIC DISTORTION (3RD HARM) is the difference, expressed in dB, between the RMS power in the input frequency at the output and the power in its 3rd harmonic level at the output.

Timing Diagrams

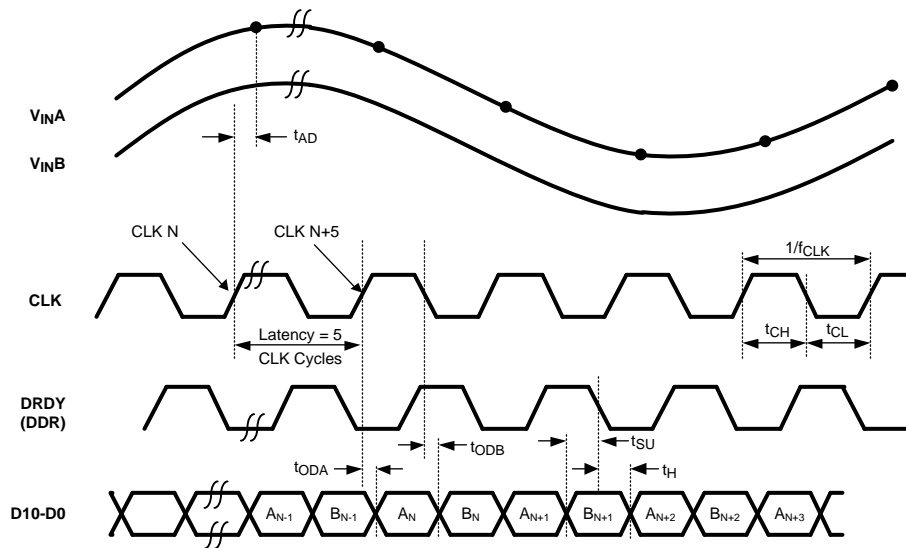

Figure 1. LVDS Output Timing

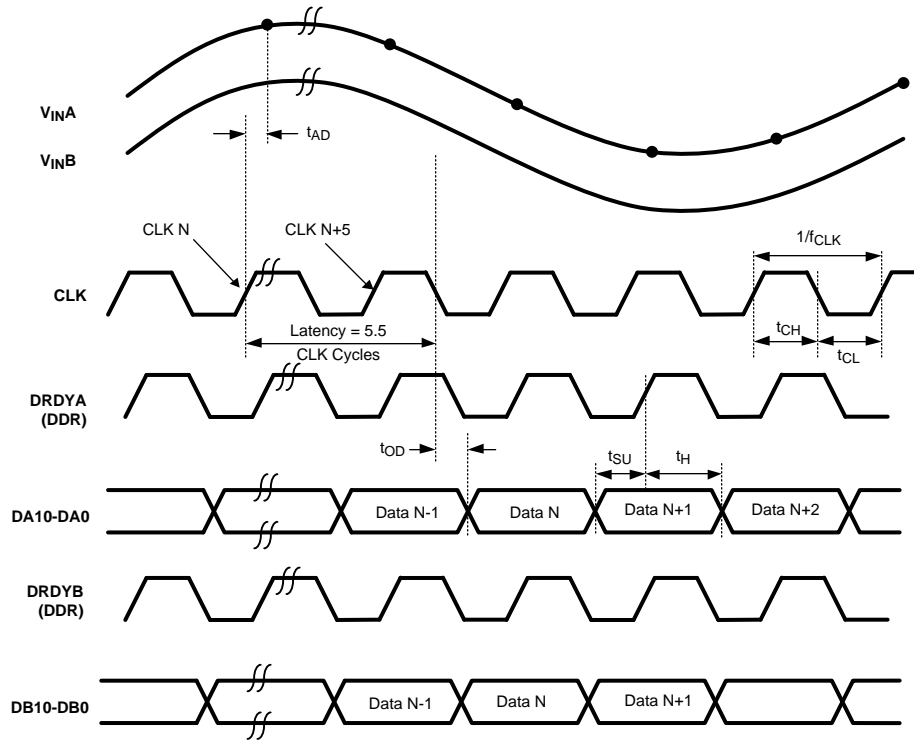

Figure 2. CMOS Output Timing

Transfer Characteristic

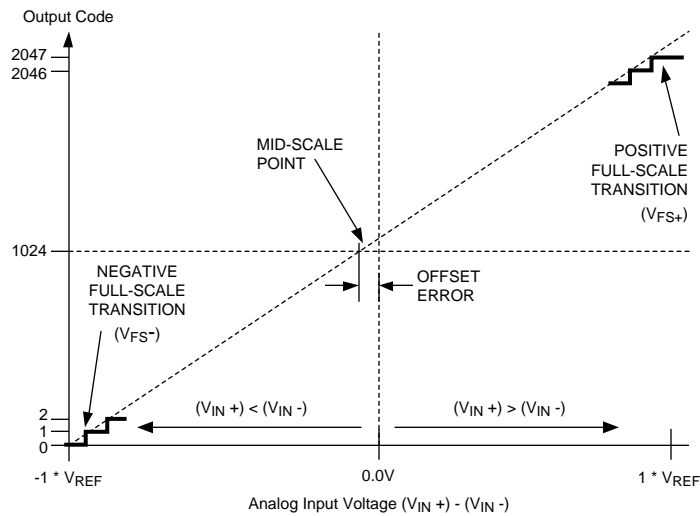

Figure 3. Transfer Characteristic

Typical Performance Characteristics DNL, INL

Unless otherwise specified, the following specifications apply: $V_{AGND} = V_{DRGND} = 0V$, $V_A = V_D = V_{DR} = +1.8V$, $f_{CLK} = 200$ MHz, 50% Duty Cycle, DCS Enabled, LVDS Output, $V_{CM} = V_{RM}$, $T_A = 25^\circ C$.

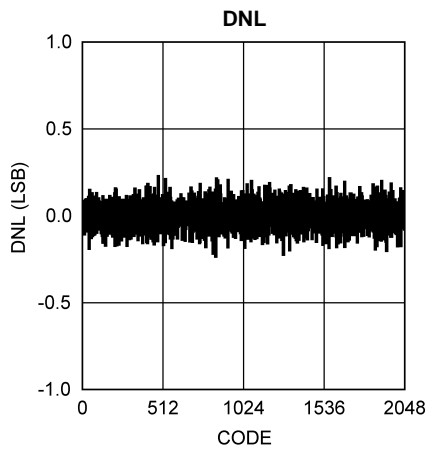

Figure 4.

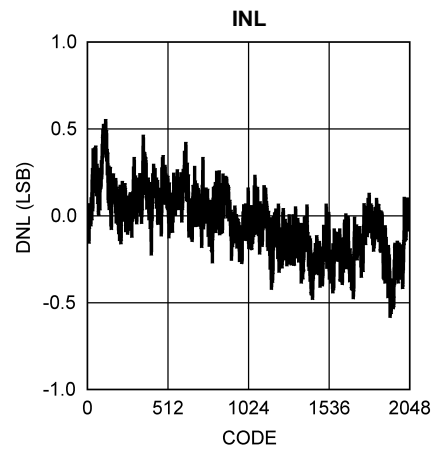

Figure 5.

Typical Performance Characteristics

Unless otherwise specified, the following specifications apply: AGND = DRGND = 0V, $V_A = V_D = V_{DR} = +1.8V$, $f_{CLK} = 200$ MHz, 50% Duty Cycle, DCS disabled, LVDS Output, $V_{CM} = V_{RM}$, $f_{IN} = 70$ MHz, $T_A = 25^\circ C$.

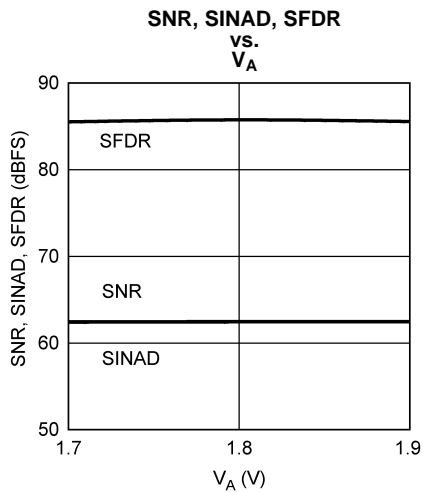

Figure 6.

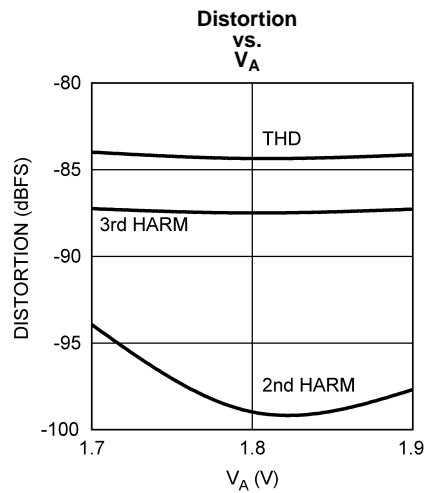

Figure 7.

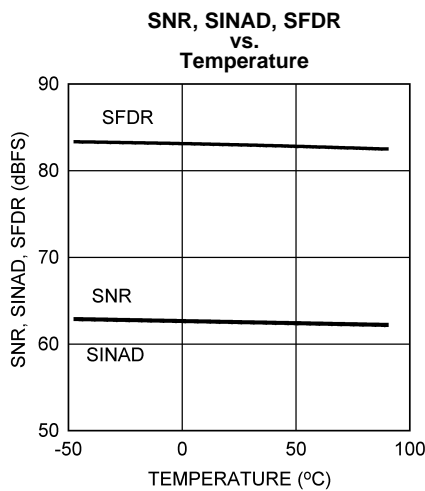

Figure 8.

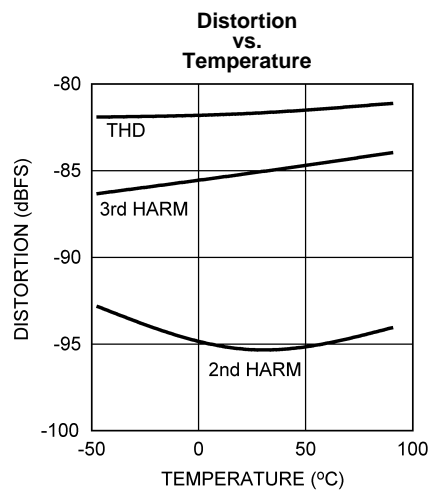

Figure 9.

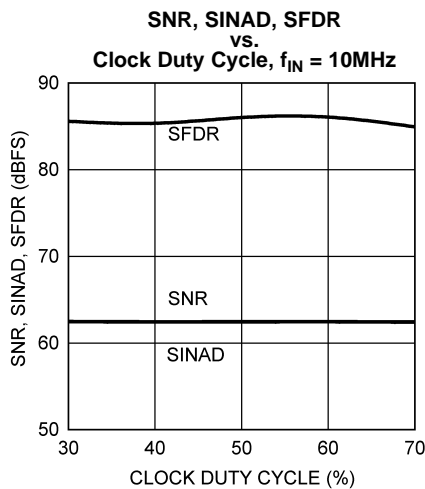

Figure 10.

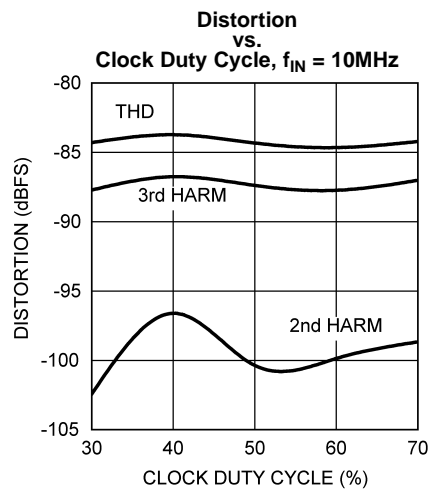

Figure 11.

Typical Performance Characteristics (continued)

Unless otherwise specified, the following specifications apply: AGND = DRGND = 0V, $V_A = V_D = V_{DR} = +1.8V$, $f_{CLK} = 200$ MHz, 50% Duty Cycle, DCS disabled, LVDS Output, $V_{CM} = V_{RM}$, $f_{IN} = 70$ MHz, $T_A = 25^\circ C$.

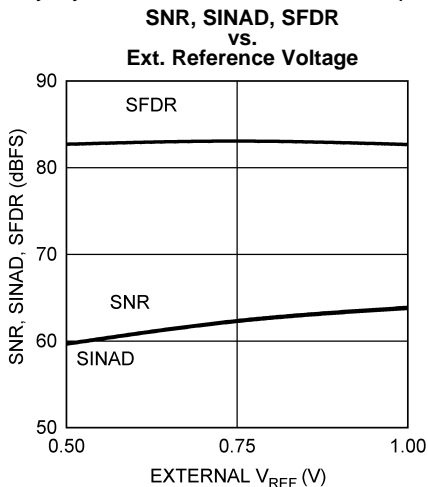

Figure 12.

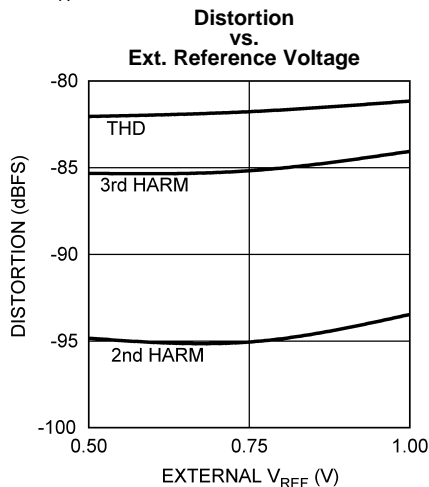

Figure 13.

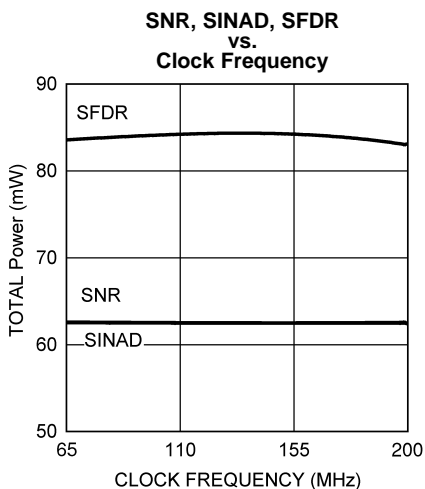

Figure 14.

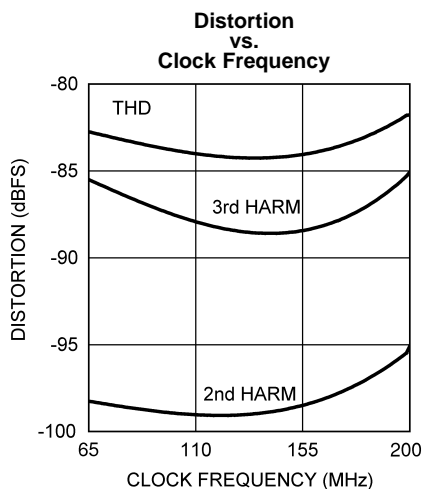

Figure 15.

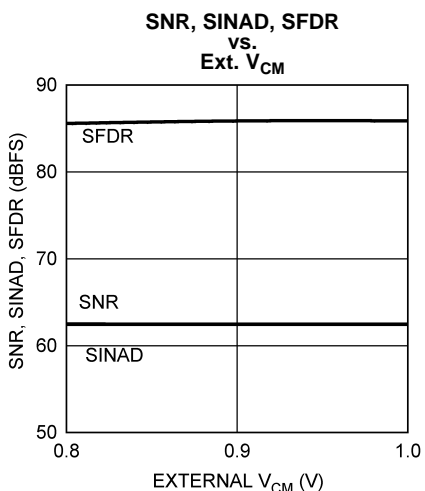

Figure 16.

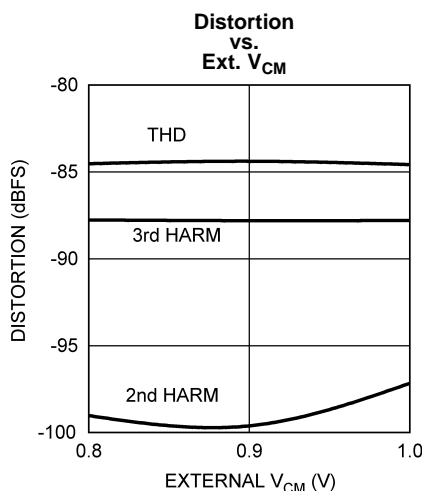

Figure 17.

Typical Performance Characteristics (continued)

Unless otherwise specified, the following specifications apply: AGND = DRGND = 0V, $V_A = V_D = V_{DR} = +1.8V$, $f_{CLK} = 200$ MHz, 50% Duty Cycle, DCS disabled, LVDS Output, $V_{CM} = V_{RM}$, $f_{IN} = 70$ MHz, $T_A = 25^\circ C$.

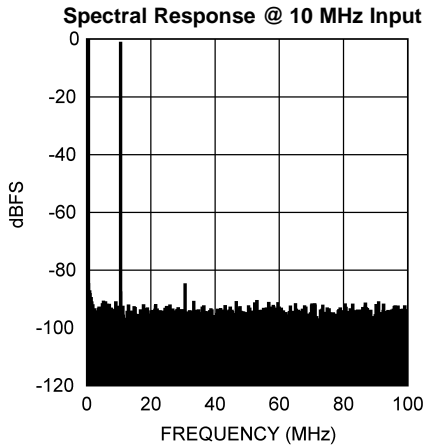

Figure 18.

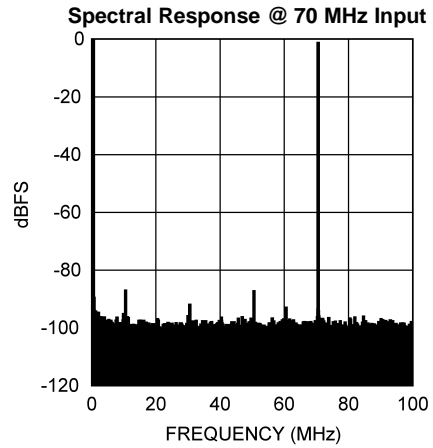

Figure 19.

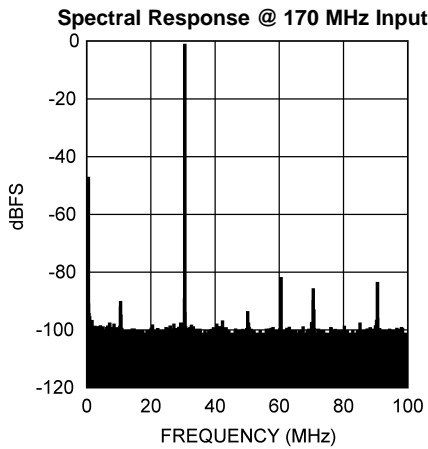

Figure 20.

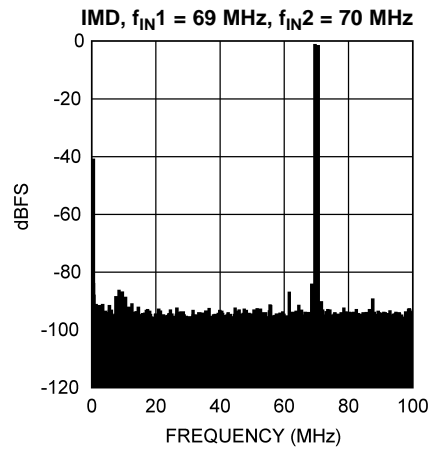

Figure 21.

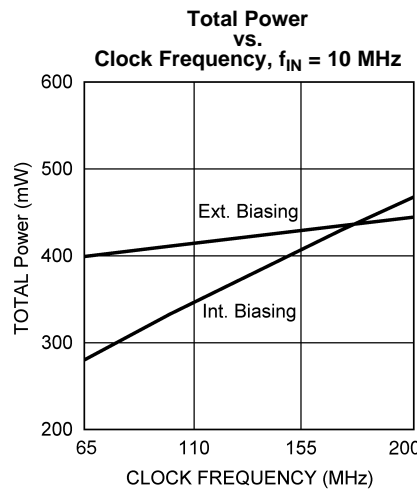

Figure 22.

FUNCTIONAL DESCRIPTION

Operating on a single +1.8V supply, the ADC11DV200 digitizes two differential analog input signals to 11 bits, using a differential pipelined architecture with error correction circuitry and an on-chip sample-and-hold circuit to ensure maximum performance. The user has the choice of using an internal 0.75V stable reference, or using an external 0.75V reference. Any external reference is buffered on-chip to ease the task of driving that pin. Duty cycle stabilization and output data format are selectable using the quad state function DF/DCS pin (pin 20). The output data can be set for offset binary or two's complement.

Applications Information

OPERATING CONDITIONS

We recommend that the following conditions be observed for operation of the ADC11DV200:

$$1.7V \leq V_A \leq 1.9V$$

$$1.7V \leq V_{DR} \leq V_A$$

$$45 \text{ MHz} \leq f_{CLK} \leq 200 \text{ MHz, with DCS off}$$

$$65 \text{ MHz} \leq f_{CLK} \leq 200 \text{ MHz, with DCS on}$$

0.75V internal reference

$$V_{REF} = 0.75V \text{ (for an external reference)}$$

$$V_{CM} = 0.9V \text{ (from } V_{RM})$$

ANALOG INPUTS

Signal Inputs

Differential Analog Input Pins

The ADC11DV200 has a pair of analog signal input pins for each of two channels. V_{IN+} and V_{IN-} form a differential input pair. The input signal, V_{IN} , is defined as

$$V_{IN} = (V_{IN+}) - (V_{IN-}) \tag{5}$$

Figure 23 shows the expected input signal range. Note that the common mode input voltage, V_{CM} , should be 0.9V. Using V_{RM} (pins 5,11) for V_{CM} will ensure the proper input common mode level for the analog input signal. The positive peaks of the individual input signals should each never exceed 2.2V. Each analog input pin of the differential pair should have a maximum peak-to-peak voltage of 1.5V, be 180° out of phase with each other and be centered around V_{CM} . The peak-to-peak voltage swing at each analog input pin should not exceed the 1V or the output data will be clipped.

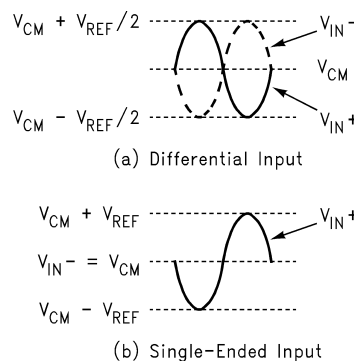

Figure 23. Expected Input Signal Range

For single frequency sine waves the full scale error in LSB can be described as approximately

$$E_{FS} = 2048 (1 - \sin(90^\circ + dev)) \tag{6}$$

Where dev is the angular difference in degrees between the two signals having a 180° relative phase relationship to each other (see Figure 24). For single frequency inputs, angular errors result in a reduction of the effective full scale input. For complex waveforms, however, angular errors will result in distortion.

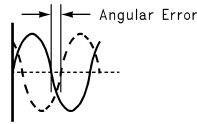

Figure 24. Angular Errors Between the Two Input Signals Will Reduce the Output Level or Cause Distortion

It is recommended to drive the analog inputs with a source impedance less than 100Ω . Matching the source impedance for the differential inputs will improve even ordered harmonic performance (particularly second harmonic).

Table 2 indicates the input to output relationship of the ADC11DV200.

Table 2. Input to Output Relationship

V_{IN}^+	V_{IN}^-	Binary Output	2's Complement Output	
$V_{CM} - V_{REF}/2$	$V_{CM} + V_{REF}/2$	000 0000 0000	100 0000 0000	Negative Full-Scale
$V_{CM} - V_{REF}/4$	$V_{CM} + V_{REF}/4$	010 0000 0000	110 0000 0000	
V_{CM}	V_{CM}	100 0000 0000	000 0000 0000	Mid-Scale
$V_{CM} + V_{REF}/4$	$V_{CM} - V_{REF}/4$	110 0000 0000	010 0000 0000	
$V_{CM} + V_{REF}/2$	$V_{CM} - V_{REF}/2$	111 1111 1111	011 1111 1111	Positive Full-Scale

Driving the Analog Inputs

The V_{IN}^+ and the V_{IN}^- inputs of the ADC11DV200 have an internal sample-and-hold circuit which consists of an analog switch followed by a switched-capacitor amplifier.

Figure 25 and Figure 26 show examples of single-ended to differential conversion circuits. The circuit in Figure 25 works well for input frequencies up to approximately 70MHz, while the circuit in Figure 26 works well above 70MHz.

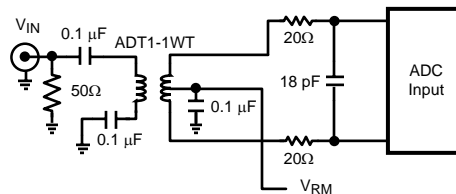

Figure 25. Low Input Frequency Transformer Drive Circuit

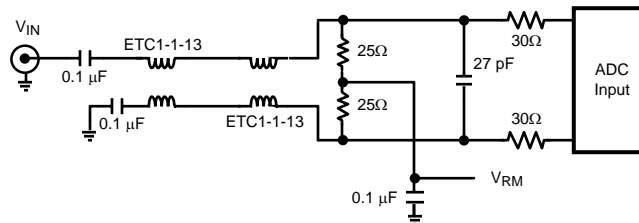

Figure 26. High Input Frequency Transformer Drive Circuit

One short-coming of using a transformer to achieve the single-ended to differential conversion is that most RF transformers have poor low frequency performance. A differential amplifier can be used to drive the analog inputs for low frequency applications. The amplifier must be fast enough to settle from the charging glitches on the analog input resulting from the sample-and-hold operation before the clock goes high and the sample is passed to the ADC core.

Input Common Mode Voltage

The input common mode voltage, V_{CM} , should be in the range of 0.8V to 1.0V and be a value such that the peak excursions of the analog signal do not go more negative than ground or more positive than the V_A supply. It is recommended to use V_{RM} (pins 5,11) as the input common mode voltage.

If the ADC11DV200 is operated with $V_A=1.8V$, a resistor of approximately 1K Ω should be used from the V_{RM} pin to AGND. This will help maintain stability over the entire temperature range when using a high supply voltage.

Reference Pins

The ADC11DV200 is designed to operate with an internal or external voltage reference. The voltage on the V_{REF} pin selects the source and level of the reference voltage. An internal 0.75 Volt reference is used when a voltage between 1.4 V to V_A is applied to the V_{REF} pin. An internal 0.5 Volt reference is used when a voltage between 0.2V and AGND is applied to the V_{REF} pin. If a voltage between 0.2V and 1.4V is applied to the V_{REF} pin, then that voltage is used for the reference. SNR will improve without a significant degradation in SFDR for $V_{REF}=1.0V$. SNR will decrease if $V_{REF}=0.5V$, yet linearity will be maintained. If using an external reference the V_{REF} pin should be bypassed to ground with a 0.1 μF capacitor close to the reference input pin.

It is important that all grounds associated with the reference voltage and the analog input signal make connection to the ground plane at a single, quiet point to minimize the effects of noise currents in the ground path.

The Reference Bypass Pins (V_{RP} , V_{RM} , and V_{RN}) for channels A and B are made available for bypass purposes. These pins should each be bypassed to AGND with a low ESL (equivalent series inductance) 0.1 μF capacitor placed very close to the pin to minimize stray inductance. A 0.1 μF capacitor should be placed between V_{RP} and V_{RN} as close to the pins as possible. This configuration is shown in [Figure 27](#). It is necessary to avoid reference oscillation, which could result in reduced SFDR and/or SNR. V_{RM} may be loaded to 1mA for use as a temperature stable 0.9V reference. The remaining pins should not be loaded.

Smaller capacitor values than those specified will allow faster recovery from the power down mode, but may result in degraded noise performance. Loading any of these pins, other than V_{RM} may result in performance degradation.

The nominal voltages for the reference bypass pins are as follows:

$$V_{RM} = 0.9 \text{ V}$$

$$V_{RP} = 1.33 \text{ V}$$

$$V_{RN} = 0.55 \text{ V}$$

DF/DCS Pin

Duty cycle stabilization and output data format are selectable using this quad state function pin. When enabled, duty cycle stabilization can compensate for clock inputs with duty cycles ranging from 30% to 70% and generate a stable internal clock, improving the performance of the part. See [Table 1](#) for DF/DCS voltage vs output format description. DCS mode of operation is limited to $65 \text{ MHz} \leq f_{CLK} \leq 200 \text{ MHz}$.

DIGITAL INPUTS

Digital CMOS compatible inputs consist of CLK, PD_A, PD_B, and OUTSEL.

Clock Input

The CLK controls the timing of the sampling process. To achieve the optimum noise performance, the clock input should be driven with a stable, low jitter clock signal in the range indicated in the [Electrical Table](#). The clock input signal should also have a short transition region. This can be achieved by passing a low-jitter sinusoidal clock source through a high speed buffer gate. The trace carrying the clock signal should be as short as possible and should not cross any other signal line, analog or digital, not even at 90°.

If the clock is interrupted, or its frequency is too low, the charge on the internal capacitors can dissipate to the point where the accuracy of the output data will degrade. This is what limits the minimum sample rate.

The clock line should be terminated at its source in the characteristic impedance of that line. Take care to maintain a constant clock line impedance throughout the length of the line. Refer to Application Note AN-905 (SNLA035) for information on setting characteristic impedance. It is highly desirable that the source driving the ADC clock pins only drive that pin.

The duty cycle of the clock signal can affect the performance of the A/D Converter. Because achieving a precise duty cycle is difficult, the ADC11DV200 has a Duty Cycle Stabilizer.

DIGITAL OUTPUTS

Digital outputs consist of the LVDS signals D0-D10 and DRDY.

The ADC11DV200 has 12 LVDS compatible data output pins: 11 data output pins corresponding to the converted input value, and a data ready (DRDY) signal that should be used to capture the output data. Valid data is present at these outputs while the PD pin is low. A-Channel data should be captured and latched with the rising edge of the DRDY signal and B-Channel data should be captured and latched with the falling edge of DRDY.

To minimize noise due to output switching, the load currents at the digital outputs should be minimized. This can be achieved by keeping the PCB traces less than 2 inches long; longer traces are more susceptible to noise. The characteristic impedance of the LVDS traces should be 100Ω, and the effective capacitance < 10pF. Try to place the 100Ω termination resistor as close to the receiving circuit as possible. (See Figure 27)

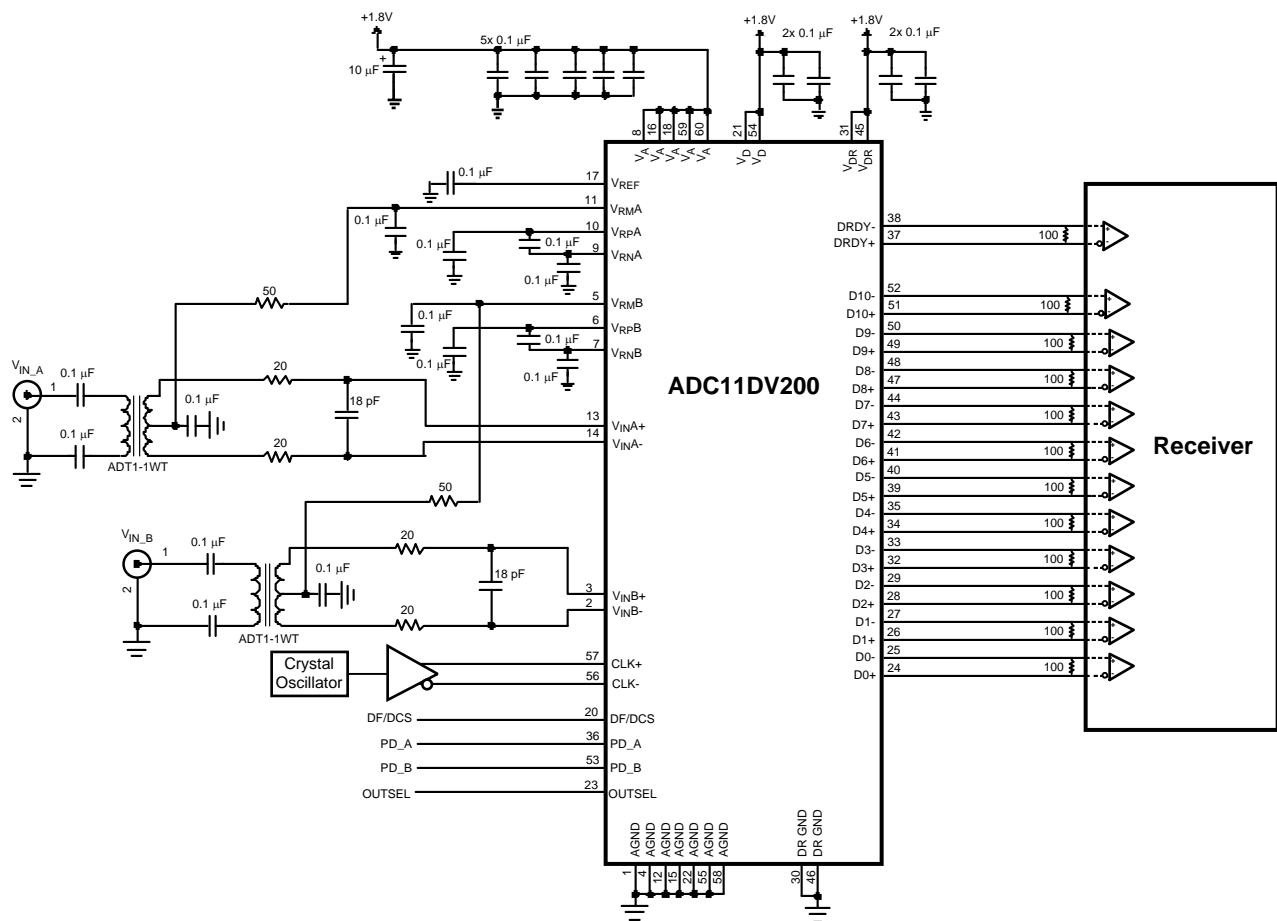

Figure 27. Application Circuit

POWER SUPPLY CONSIDERATIONS

The power supply pins should be bypassed with a 0.1 μF capacitor and with a 100 pF ceramic chip capacitor close to each power pin. Leadless chip capacitors are preferred because they have low series inductance.

As is the case with all high-speed converters, the ADC11DV200 is sensitive to power supply noise. Accordingly, the noise on the analog supply pin should be kept below 100 mV_{P-P}.

No pin should ever have a voltage on it that is in excess of the supply voltages, not even on a transient basis. Be especially careful of this during power turn on and turn off.

REVISION HISTORY

Changes from Original (April 2013) to Revision A	Page
• Changed layout of National Data Sheet to TI format	23

PACKAGING INFORMATION

Orderable part number	Status (1)	Material type (2)	Package Pins	Package qty Carrier	RoHS (3)	Lead finish/ Ball material (4)	MSL rating/ Peak reflow (5)	Op temp (°C)	Part marking (6)
ADC11DV200CISQ/NO.A	Active	Production	WQFN (NKA) 60	1000 SMALL T&R	Yes	SN	Level-3-260C-168 HR	-40 to 85	11DV200 CISQ
ADC11DV200CISQ/NOPB	Active	Production	WQFN (NKA) 60	1000 SMALL T&R	Yes	SN	Level-3-260C-168 HR	-40 to 85	11DV200 CISQ
ADC11DV200CISQE/NO.A	Active	Production	WQFN (NKA) 60	250 SMALL T&R	Yes	SN	Level-3-260C-168 HR	-40 to 85	11DV200 CISQ
ADC11DV200CISQE/NOPB	Active	Production	WQFN (NKA) 60	250 SMALL T&R	Yes	SN	Level-3-260C-168 HR	-40 to 85	11DV200 CISQ
ADC11DV200CISQX/NO.A	Active	Production	WQFN (NKA) 60	2000 LARGE T&R	Yes	SN	Level-3-260C-168 HR	-40 to 85	11DV200 CISQ
ADC11DV200CISQX/NOPB	Active	Production	WQFN (NKA) 60	2000 LARGE T&R	Yes	SN	Level-3-260C-168 HR	-40 to 85	11DV200 CISQ

(1) **Status:** For more details on status, see our [product life cycle](#).

(2) **Material type:** When designated, preproduction parts are prototypes/experimental devices, and are not yet approved or released for full production. Testing and final process, including without limitation quality assurance, reliability performance testing, and/or process qualification, may not yet be complete, and this item is subject to further changes or possible discontinuation. If available for ordering, purchases will be subject to an additional waiver at checkout, and are intended for early internal evaluation purposes only. These items are sold without warranties of any kind.

(3) **RoHS values:** Yes, No, RoHS Exempt. See the [TI RoHS Statement](#) for additional information and value definition.

(4) **Lead finish/Ball material:** Parts may have multiple material finish options. Finish options are separated by a vertical ruled line. Lead finish/Ball material values may wrap to two lines if the finish value exceeds the maximum column width.

(5) **MSL rating/Peak reflow:** The moisture sensitivity level ratings and peak solder (reflow) temperatures. In the event that a part has multiple moisture sensitivity ratings, only the lowest level per JEDEC standards is shown. Refer to the shipping label for the actual reflow temperature that will be used to mount the part to the printed circuit board.

(6) **Part marking:** There may be an additional marking, which relates to the logo, the lot trace code information, or the environmental category of the part.

Multiple part markings will be inside parentheses. Only one part marking contained in parentheses and separated by a "~" will appear on a part. If a line is indented then it is a continuation of the previous line and the two combined represent the entire part marking for that device.

Important Information and Disclaimer: The information provided on this page represents TI's knowledge and belief as of the date that it is provided. TI bases its knowledge and belief on information provided by third parties, and makes no representation or warranty as to the accuracy of such information. Efforts are underway to better integrate information from third parties. TI has taken and continues to take reasonable steps to provide representative and accurate information but may not have conducted destructive testing or chemical analysis on incoming materials and chemicals. TI and TI suppliers consider certain information to be proprietary, and thus CAS numbers and other limited information may not be available for release.

In no event shall TI's liability arising out of such information exceed the total purchase price of the TI part(s) at issue in this document sold by TI to Customer on an annual basis.

TAPE AND REEL INFORMATION

QUADRANT ASSIGNMENTS FOR PIN 1 ORIENTATION IN TAPE

*All dimensions are nominal

Device	Package Type	Package Drawing	Pins	SPQ	Reel Diameter (mm)	Reel Width W1 (mm)	A0 (mm)	B0 (mm)	K0 (mm)	P1 (mm)	W (mm)	Pin1 Quadrant
ADC11DV200CISQ/NOPB	WQFN	NKA	60	1000	330.0	16.4	9.3	9.3	1.3	12.0	16.0	Q1
ADC11DV200CISQE/NOPB	WQFN	NKA	60	250	178.0	16.4	9.3	9.3	1.3	12.0	16.0	Q1
ADC11DV200CISQX/NOPB	WQFN	NKA	60	2000	330.0	16.4	9.3	9.3	1.3	12.0	16.0	Q1

TAPE AND REEL BOX DIMENSIONS

*All dimensions are nominal

Device	Package Type	Package Drawing	Pins	SPQ	Length (mm)	Width (mm)	Height (mm)
ADC11DV200CISQ/NOPB	WQFN	NKA	60	1000	356.0	356.0	36.0
ADC11DV200CISQE/ NOPB	WQFN	NKA	60	250	208.0	191.0	35.0
ADC11DV200CISQX/ NOPB	WQFN	NKA	60	2000	356.0	356.0	36.0

NKA0060A

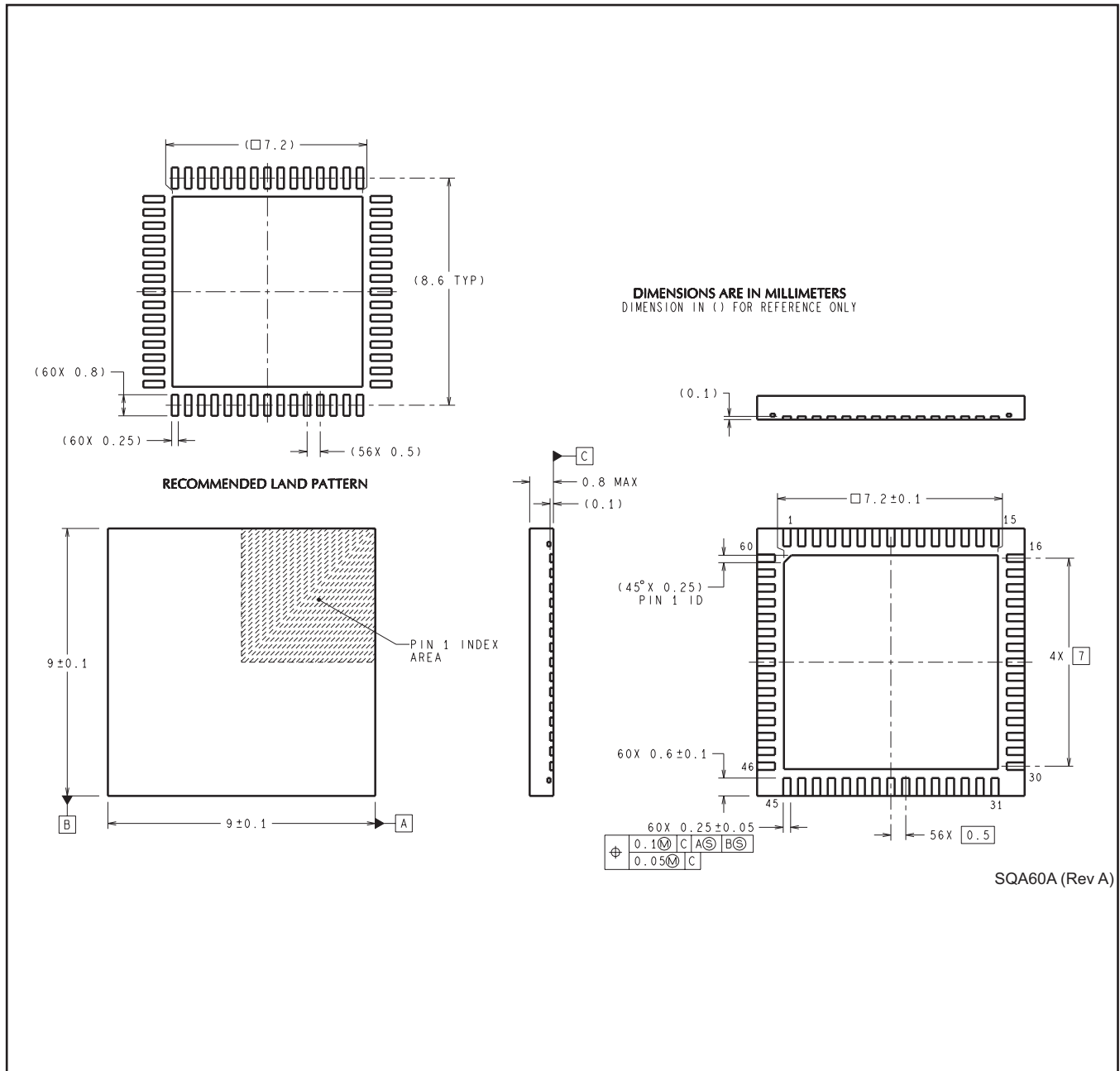

IMPORTANT NOTICE AND DISCLAIMER

TI PROVIDES TECHNICAL AND RELIABILITY DATA (INCLUDING DATASHEETS), DESIGN RESOURCES (INCLUDING REFERENCE DESIGNS), APPLICATION OR OTHER DESIGN ADVICE, WEB TOOLS, SAFETY INFORMATION, AND OTHER RESOURCES "AS IS" AND WITH ALL FAULTS, AND DISCLAIMS ALL WARRANTIES, EXPRESS AND IMPLIED, INCLUDING WITHOUT LIMITATION ANY IMPLIED WARRANTIES OF MERCHANTABILITY, FITNESS FOR A PARTICULAR PURPOSE OR NON-INFRINGEMENT OF THIRD PARTY INTELLECTUAL PROPERTY RIGHTS.

These resources are intended for skilled developers designing with TI products. You are solely responsible for (1) selecting the appropriate TI products for your application, (2) designing, validating and testing your application, and (3) ensuring your application meets applicable standards, and any other safety, security, regulatory or other requirements.

These resources are subject to change without notice. TI grants you permission to use these resources only for development of an application that uses the TI products described in the resource. Other reproduction and display of these resources is prohibited. No license is granted to any other TI intellectual property right or to any third party intellectual property right. TI disclaims responsibility for, and you fully indemnify TI and its representatives against any claims, damages, costs, losses, and liabilities arising out of your use of these resources.

TI's products are provided subject to [TI's Terms of Sale](#), [TI's General Quality Guidelines](#), or other applicable terms available either on [ti.com](#) or provided in conjunction with such TI products. TI's provision of these resources does not expand or otherwise alter TI's applicable warranties or warranty disclaimers for TI products. Unless TI explicitly designates a product as custom or customer-specified, TI products are standard, catalog, general purpose devices.

TI objects to and rejects any additional or different terms you may propose.

Copyright © 2025, Texas Instruments Incorporated

Last updated 10/2025