

# N-Channel NexFET Power MOSFETs

## 1 Features

- Optimized for 5 V Gate Drive
- Ultralow  $Q_g$  and  $Q_{gd}$
- Low Thermal Resistance
- Avalanche Rated
- Pb Free Terminal Plating
- RoHS Compliant
- Halogen Free
- SON 5-mm × 6-mm Plastic Package

## 2 Applications

- Point-of-Load Synchronous Buck in Networking, Telecom and Computing Systems
- Optimized for Synchronous FET Applications

## 3 Description

The NexFET™ power MOSFET has been designed to minimize losses in power conversion applications and optimized for 5 V gate drive applications.

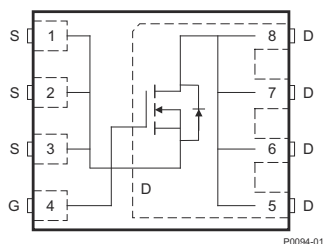

Top View

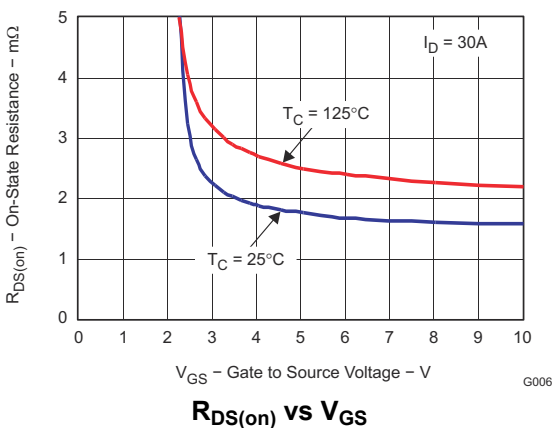

## Product Summary

$V_{DS}$	Drain to Source Voltage	25	V
$Q_g$	Gate Charge Total (4.5 V)	18	nC
$Q_{gd}$	Gate Charge Gate to Drain	3.5	nC
$R_{DS(on)}$	Drain to Source On Resistance	$V_{GS} = 3\text{ V}$	2.1 mΩ
		$V_{GS} = 4.5\text{ V}$	1.7 mΩ
		$V_{GS} = 8\text{ V}$	1.5 mΩ
$V_{GS(th)}$	Threshold Voltage	1.1	V

## Ordering Information

Device	Package	Media	Qty	Ship
CSD16325Q5	SON 5-mm × 6-mm Plastic Package	13-Inch Reel	2500	Tape and Reel

## Absolute Maximum Ratings

$T_A = 25^\circ\text{C}$ unless otherwise stated		VALUE	UNIT
$V_{DS}$	Drain to Source Voltage	25	V
$V_{GS}$	Gate to Source Voltage	+10 / -8	V
$I_D$	Continuous Drain Current, $T_C = 25^\circ\text{C}$	100	A
	Continuous Drain Current <sup>(1)</sup>	33	A
$I_{DM}$	Pulsed Drain Current, $T_A = 25^\circ\text{C}$ <sup>(2)</sup>	200	A
$P_D$	Power Dissipation <sup>(1)</sup>	3.1	W
$T_J, T_{STG}$	Operating Junction and Storage Temperature Range	-55 to 150	°C
$E_{AS}$	Avalanche Energy, single pulse $I_D = 100\text{ A}, L = 0.1\text{ mH}, R_G = 25\ \Omega$	500	mJ

- (1) Typical  $R_{\theta JA} = 38^\circ\text{C/W}$  on 1-inch<sup>2</sup> (6.45-cm<sup>2</sup>), 2-oz. (0.071-mm thick) Cu pad on a 0.06-inch (1.52-mm) thick FR4 PCB.
- (2) Pulse duration  $\leq 300\ \mu\text{s}$ , duty cycle  $\leq 2\%$

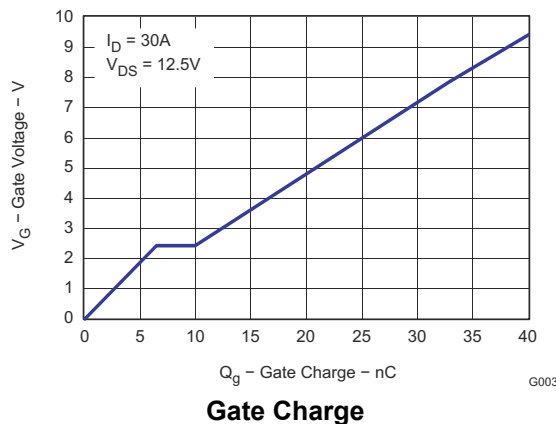

## Table of Contents

<b>1 Features</b> .....	<b>1</b>	<b>4 Electrical Characteristics</b> .....	<b>3</b>
<b>2 Applications</b> .....	<b>1</b>	<b>5 Thermal Characteristics</b> .....	<b>3</b>
<b>3 Description</b> .....	<b>1</b>	<b>6 Typical MOSFET Characteristics</b> .....	<b>4</b>
<b>Revision History</b> .....	<b>2</b>	<b>7 Mechanical, Packaging, and Orderable Information</b> ....	<b>7</b>

## Revision History

NOTE: Page numbers for previous revisions may differ from page numbers in the current version.

### Changes from Revision C (April 2010) to Revision D (October 2023) Page

- Updated the numbering format for tables, figures, and cross-references throughout the document..... **1**

### Changes from Revision B (April 2010) to Revision C (April 2010) Page

- Changed  $R_{DS(on)}$ ,  $V_{GS} = 3\text{ V}$  in the Electrical Characteristics table From: 2.7 to 2.9 in the max column..... **3**

## 4 Electrical Characteristics

( $T_A = 25^\circ\text{C}$  unless otherwise stated)

PARAMETER		TEST CONDITIONS	MIN	TYP	MAX	UNIT
<b>Static Characteristics</b>						
$BV_{DSS}$	Drain to Source Voltage	$V_{GS} = 0\text{ V}, I_D = 250\ \mu\text{A}$	25			V
$I_{DSS}$	Drain to Source Leakage Current	$V_{GS} = 0\text{ V}, V_{DS} = 20\text{ V}$			1	$\mu\text{A}$
$I_{GSS}$	Gate to Source Leakage Current	$V_{DS} = 0\text{ V}, V_{GS} = +10/-8\text{ V}$			100	nA
$V_{GS(th)}$	Gate to Source Threshold Voltage	$V_{DS} = V_{GS}, I_D = 250\ \mu\text{A}$	0.9	1.1	1.4	V
$R_{DS(on)}$	Drain to Source On Resistance	$V_{GS} = 3\text{ V}, I_D = 30\text{ A}$		2.1	2.9	m $\Omega$
		$V_{GS} = 4.5\text{ V}, I_D = 30\text{ A}$		1.7	2.2	m $\Omega$
		$V_{GS} = 8\text{ V}, I_D = 30\text{ A}$		1.5	2	m $\Omega$
$g_{fs}$	Transconductance	$V_{DS} = 15\text{ V}, I_D = 30\text{ A}$		159		S
<b>Dynamic Characteristics</b>						
$C_{iss}$	Input Capacitance	$V_{GS} = 0\text{ V}, V_{DS} = 12.5\text{ V},$ $f = 1\text{ MHz}$		3070	4000	pF
$C_{oss}$	Output Capacitance			2190	2850	pF
$C_{riss}$	Reverse Transfer Capacitance			120	150	pF
$R_G$	Series Gate Resistance			1.6	3.2	$\Omega$
$Q_g$	Gate Charge Total (4.5 V)			18	25	nC
$Q_{gd}$	Gate Charge – Gate to Drain	$V_{DS} = 12.5\text{ V},$ $I_{DS} = 30\text{ A}$		3.5		nC
$Q_{gs}$	Gate Charge – Gate to Source			6.6		nC
$Q_{g(th)}$	Gate Charge at $V_{th}$			3.3		nC
$Q_{oss}$	Output Charge	$V_{DS} = 13\text{ V}, V_{GS} = 0\text{ V}$		43		nC
$t_{d(on)}$	Turn On Delay Time	$V_{DS} = 12.5\text{ V}, V_{GS} = 4.5\text{ V},$ $I_{DS} = 30\text{ A}, R_G = 2\ \Omega$		10.5		ns
$t_r$	Rise Time			16		ns
$t_{d(off)}$	Turn Off Delay Time			32		ns
$t_f$	Fall Time			12		ns
<b>Diode Characteristics</b>						
$V_{SD}$	Diode Forward Voltage	$I_{DS} = 30\text{ A}, V_{GS} = 0\text{ V}$		0.8	1	V
$Q_{rr}$	Reverse Recovery Charge	$V_{DD} = 10\text{ V}, I_F = 30\text{ A}, di/dt = 300\text{ A}/\mu\text{s}$		63		nC
$t_{rr}$	Reverse Recovery Time	$V_{DD} = 10\text{ V}, I_F = 30\text{ A}, di/dt = 300\text{ A}/\mu\text{s}$		47		ns

## 5 Thermal Characteristics

( $T_A = 25^\circ\text{C}$  unless otherwise stated)

PARAMETER		MIN	TYP	MAX	UNIT
$R_{\theta JC}$	Thermal Resistance Junction to Case <sup>(1)</sup>			1	$^\circ\text{C}/\text{W}$
$R_{\theta JA}$	Thermal Resistance Junction to Ambient <sup>(1) (2)</sup>			50	$^\circ\text{C}/\text{W}$

- $R_{\theta JC}$  is determined with the device mounted on a 1-inch<sup>2</sup> (6.45-cm<sup>2</sup>), 2-oz. (0.071-mm thick) Cu pad on a 1.5-inch × 1.5-inch (3.81-cm × 3.81-cm), 0.06-inch (1.52-mm) thick FR4 PCB.  $R_{\theta JC}$  is specified by design, whereas  $R_{\theta JA}$  is determined by the user's board design.
- Device mounted on FR4 material with 1-inch<sup>2</sup> (6.45-cm<sup>2</sup>), 2-oz. (0.071-mm thick) Cu.

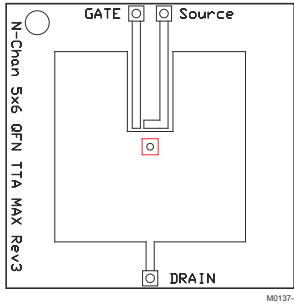

Max  $R_{\theta JA}$  = 50°C/W  
when mounted on 1 inch<sup>2</sup>  
(6.45 cm<sup>2</sup>) of 2-oz. (0.071-  
mm thick) Cu.

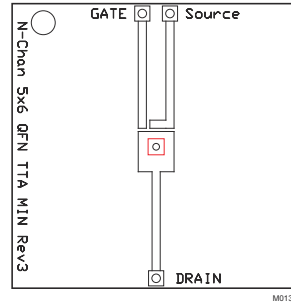

Max  $R_{\theta JA}$  = 126°C/W when  
mounted on minimum pad  
area of 2-oz. (0.071-mm  
thick) Cu.

## 6 Typical MOSFET Characteristics

( $T_A$  = 25°C unless otherwise stated)

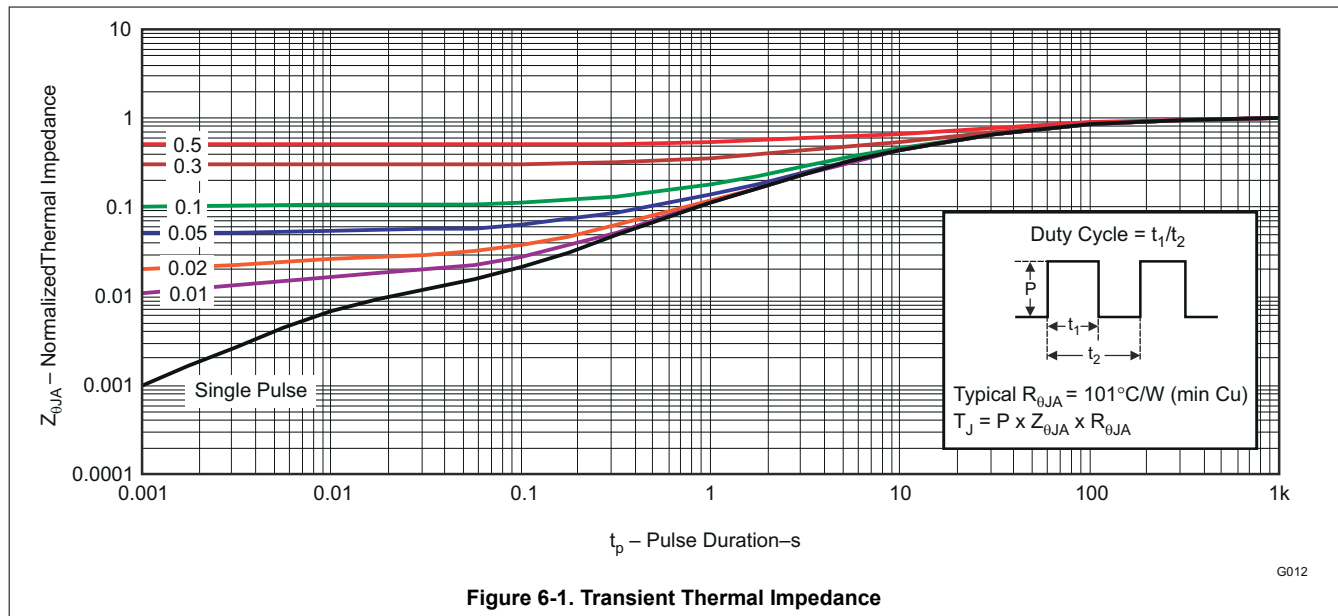

## 6 Typical MOSFET Characteristics

( $T_A = 25^\circ\text{C}$  unless otherwise stated)

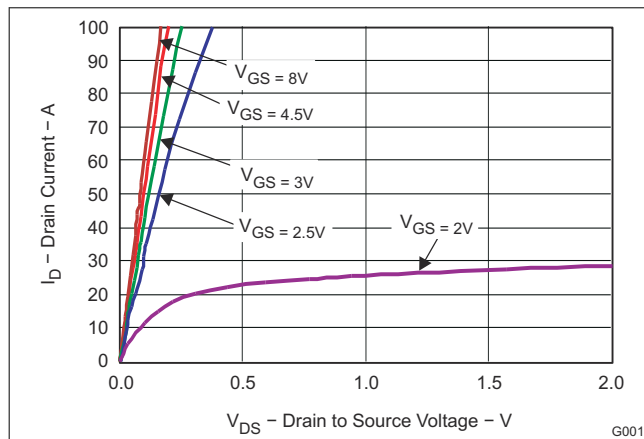

**Figure 6-2. Saturation Characteristics**

G001

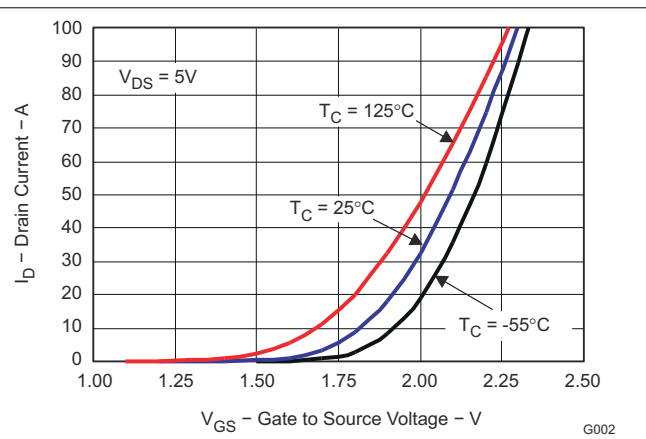

**Figure 6-3. Transfer Characteristics**

G002

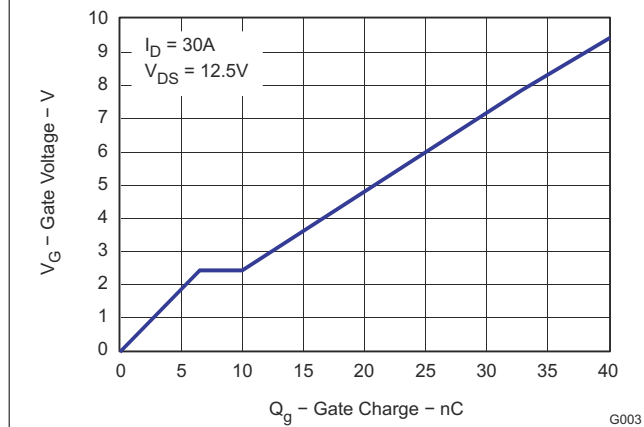

**Figure 6-4. Gate Charge**

G003

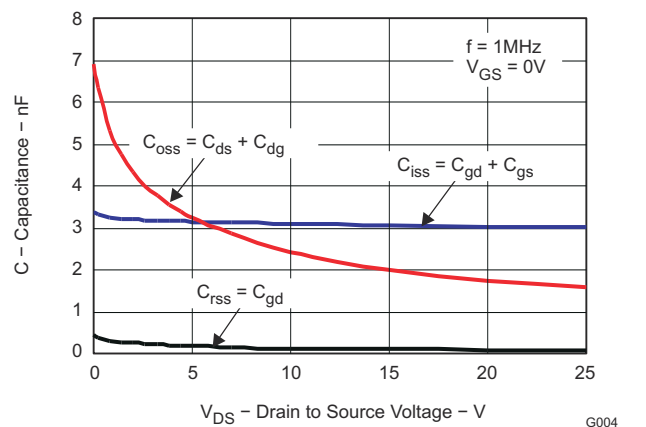

**Figure 6-5. Capacitance**

G004

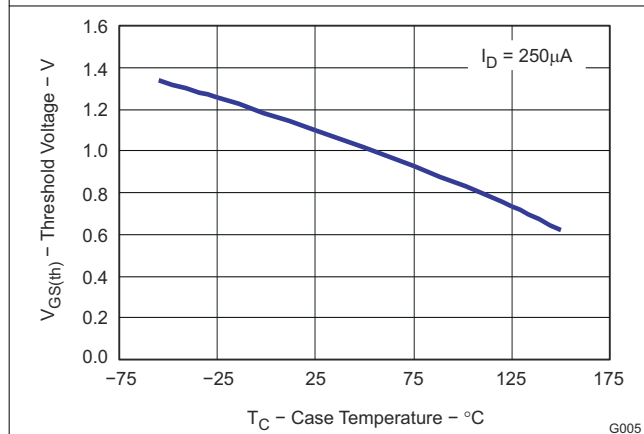

**Figure 6-6. Threshold Voltage vs. Temperature**

G005

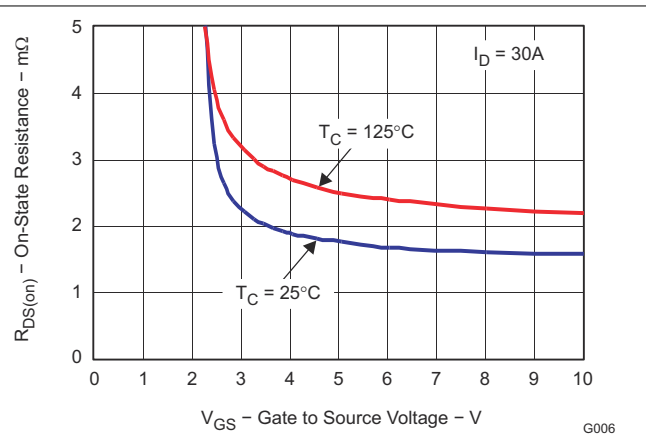
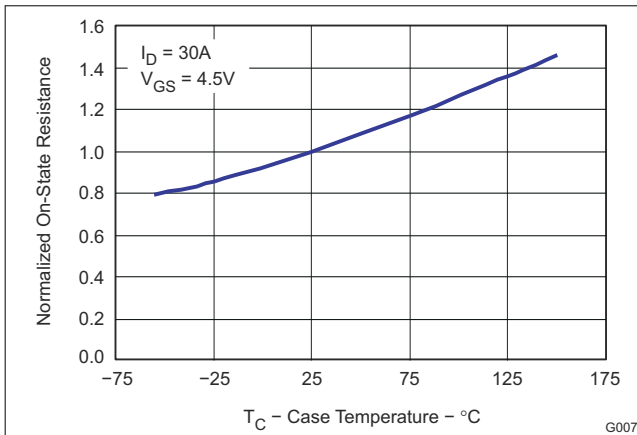

**Figure 6-7. On-State Resistance vs. Gate to Source Voltage**

G006

## 6 Typical MOSFET Characteristics (continued)

( $T_A = 25^\circ\text{C}$  unless otherwise stated)



**Figure 6-8. Normalized On-State Resistance vs. Temperature**

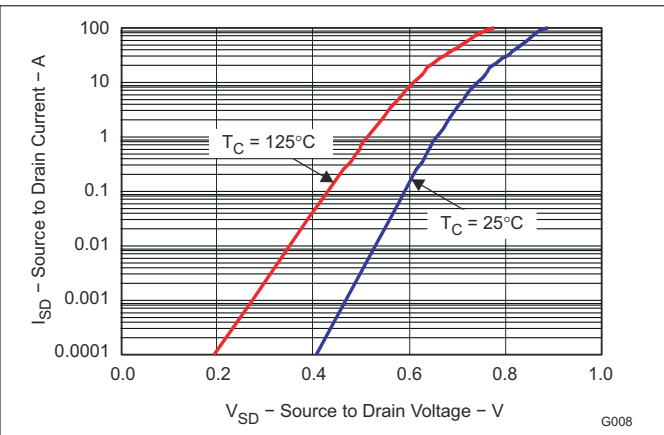

**Figure 6-9. Typical Diode Forward Voltage**

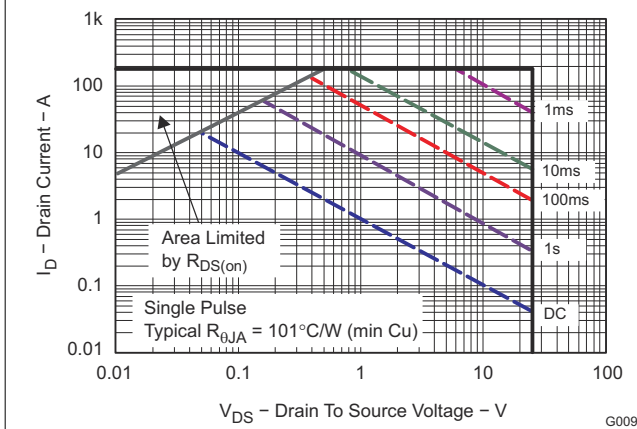

**Figure 6-10. Maximum Safe Operating Area**

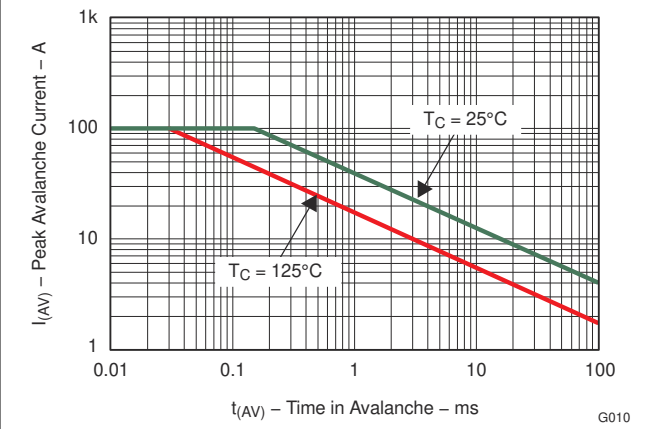

**Figure 6-11. Single Pulse Unclamped Inductive Switching**

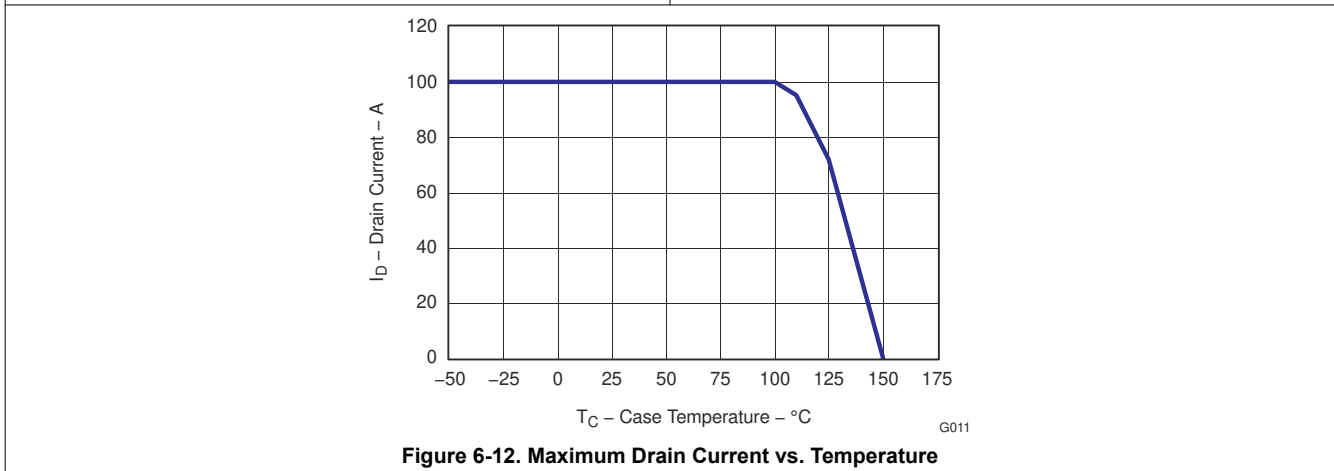

**Figure 6-12. Maximum Drain Current vs. Temperature**

## 7 Mechanical, Packaging, and Orderable Information

The following pages include mechanical, packaging, and orderable information. This information is the most current data available for the designated devices. This data is subject to change without notice and revision of this document. For browser-based versions of this data sheet, refer to the left-hand navigation.

**PACKAGING INFORMATION**

Orderable part number	Status (1)	Material type (2)	Package   Pins	Package qty   Carrier	RoHS (3)	Lead finish/ Ball material (4)	MSL rating/ Peak reflow (5)	Op temp (°C)	Part marking (6)
<a href="#">CSD16325Q5</a>	Active	Production	VSON-CLIP (DQH)   8	2500   LARGE T&R	ROHS Exempt	SN	Level-1-260C-UNLIM	-55 to 150	CSD16325
CSD16325Q5.B	Active	Production	VSON-CLIP (DQH)   8	2500   LARGE T&R	ROHS Exempt	SN	Level-1-260C-UNLIM	-55 to 150	CSD16325

(1) **Status:** For more details on status, see our [product life cycle](#).

(2) **Material type:** When designated, preproduction parts are prototypes/experimental devices, and are not yet approved or released for full production. Testing and final process, including without limitation quality assurance, reliability performance testing, and/or process qualification, may not yet be complete, and this item is subject to further changes or possible discontinuation. If available for ordering, purchases will be subject to an additional waiver at checkout, and are intended for early internal evaluation purposes only. These items are sold without warranties of any kind.

(3) **RoHS values:** Yes, No, RoHS Exempt. See the [TI RoHS Statement](#) for additional information and value definition.

(4) **Lead finish/Ball material:** Parts may have multiple material finish options. Finish options are separated by a vertical ruled line. Lead finish/Ball material values may wrap to two lines if the finish value exceeds the maximum column width.

(5) **MSL rating/Peak reflow:** The moisture sensitivity level ratings and peak solder (reflow) temperatures. In the event that a part has multiple moisture sensitivity ratings, only the lowest level per JEDEC standards is shown. Refer to the shipping label for the actual reflow temperature that will be used to mount the part to the printed circuit board.

(6) **Part marking:** There may be an additional marking, which relates to the logo, the lot trace code information, or the environmental category of the part.

Multiple part markings will be inside parentheses. Only one part marking contained in parentheses and separated by a "~" will appear on a part. If a line is indented then it is a continuation of the previous line and the two combined represent the entire part marking for that device.

**Important Information and Disclaimer:**The information provided on this page represents TI's knowledge and belief as of the date that it is provided. TI bases its knowledge and belief on information provided by third parties, and makes no representation or warranty as to the accuracy of such information. Efforts are underway to better integrate information from third parties. TI has taken and continues to take reasonable steps to provide representative and accurate information but may not have conducted destructive testing or chemical analysis on incoming materials and chemicals. TI and TI suppliers consider certain information to be proprietary, and thus CAS numbers and other limited information may not be available for release.

In no event shall TI's liability arising out of such information exceed the total purchase price of the TI part(s) at issue in this document sold by TI to Customer on an annual basis.



DQH0008A



# PACKAGE OUTLINE

VSON-CLIP - 1.05 mm max height

PLASTIC SMALL OUTLINE - NO LEAD

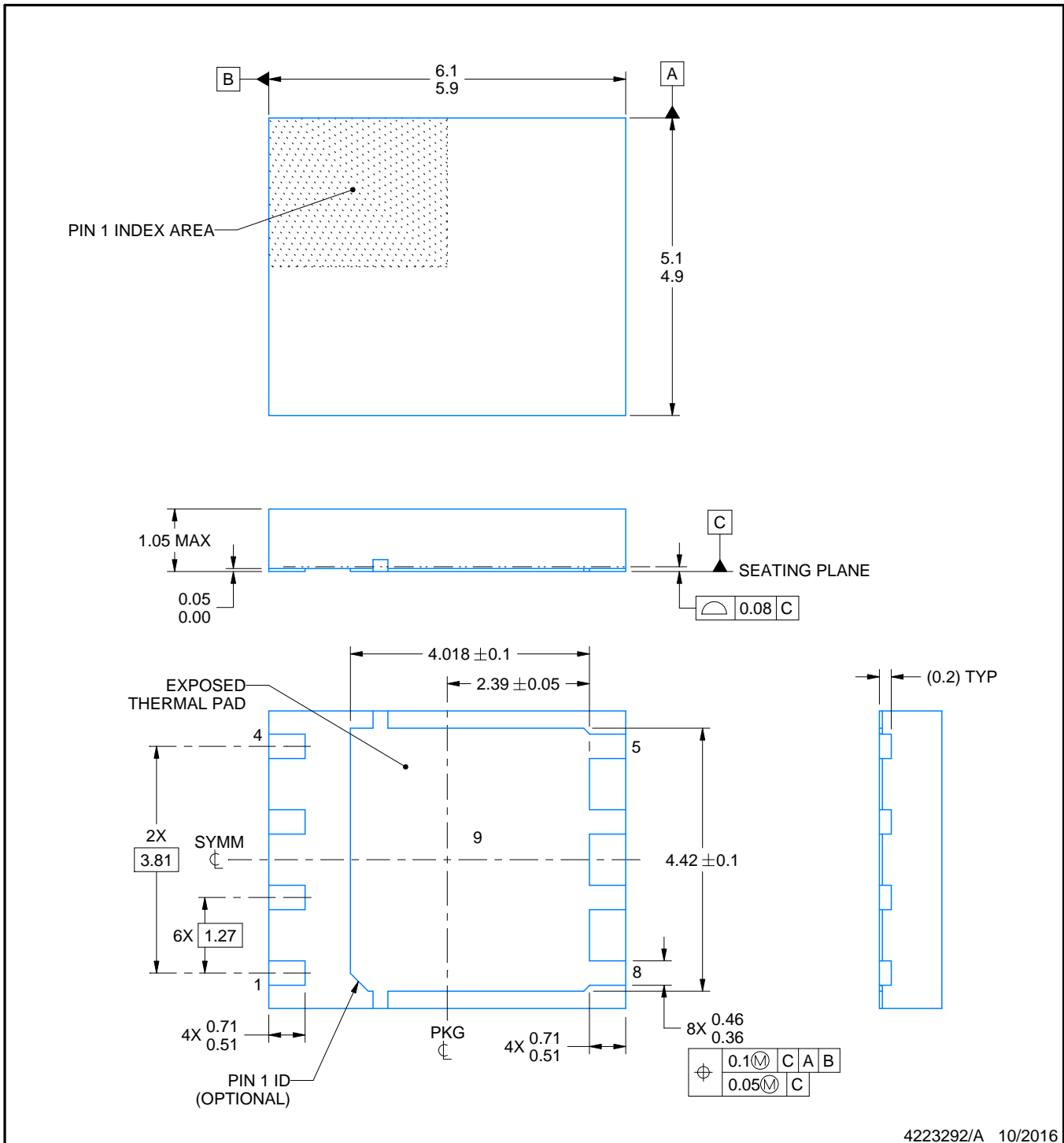

## NOTES:

1. All linear dimensions are in millimeters. Any dimensions in parenthesis are for reference only. Dimensioning and tolerancing per ASME Y14.5M.
2. This drawing is subject to change without notice.
3. The package thermal pad must be soldered to the printed circuit board for thermal and mechanical performance.

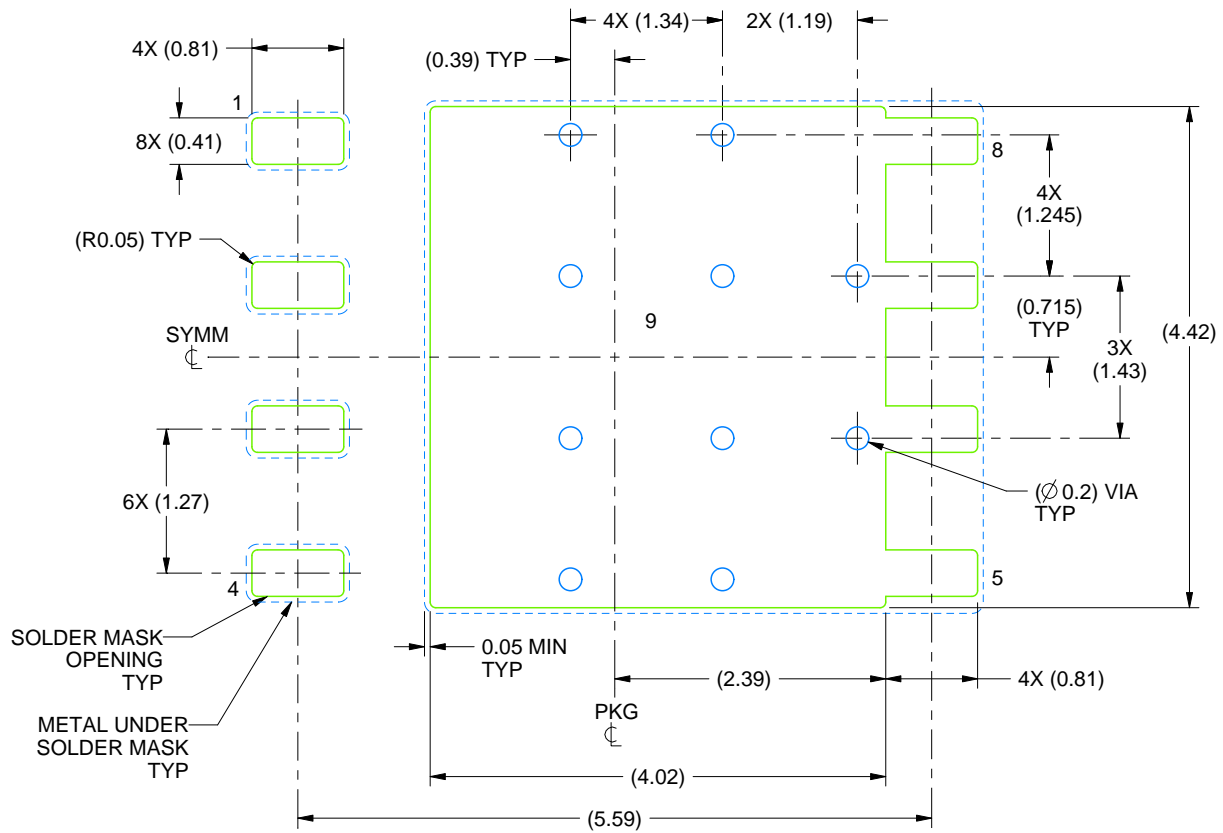

LAND PATTERN EXAMPLE  
SOLDER MASK DEFINED  
SCALE:15X

4223292/A 10/2016

NOTES: (continued)

4. This package is designed to be soldered to a thermal pad on the board. For more information, see Texas Instruments literature number SLUA271 ([www.ti.com/lit/sluea271](http://www.ti.com/lit/sluea271)).
5. Vias are optional depending on application, refer to device data sheet. If some or all are implemented, recommended via locations are shown.

# EXAMPLE STENCIL DESIGN

DQH0008A

VSON-CLIP - 1.05 mm max height

PLASTIC SMALL OUTLINE - NO LEAD

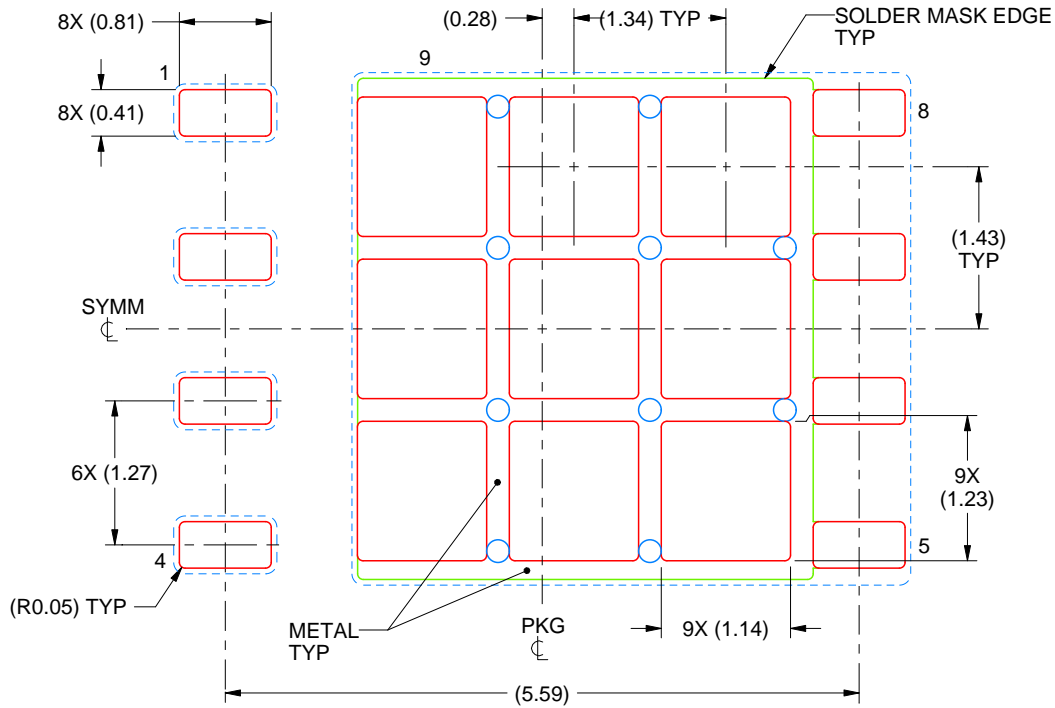

SOLDER PASTE EXAMPLE  
BASED ON 0.125 mm THICK STENCIL

EXPOSED PAD 9:  
71% PRINTED SOLDER COVERAGE BY AREA UNDER PACKAGE  
SCALE:15X

4223292/A 10/2016

NOTES: (continued)

6. Laser cutting apertures with trapezoidal walls and rounded corners may offer better paste release. IPC-7525 may have alternate design recommendations.

## IMPORTANT NOTICE AND DISCLAIMER

TI PROVIDES TECHNICAL AND RELIABILITY DATA (INCLUDING DATASHEETS), DESIGN RESOURCES (INCLUDING REFERENCE DESIGNS), APPLICATION OR OTHER DESIGN ADVICE, WEB TOOLS, SAFETY INFORMATION, AND OTHER RESOURCES "AS IS" AND WITH ALL FAULTS, AND DISCLAIMS ALL WARRANTIES, EXPRESS AND IMPLIED, INCLUDING WITHOUT LIMITATION ANY IMPLIED WARRANTIES OF MERCHANTABILITY, FITNESS FOR A PARTICULAR PURPOSE OR NON-INFRINGEMENT OF THIRD PARTY INTELLECTUAL PROPERTY RIGHTS.

These resources are intended for skilled developers designing with TI products. You are solely responsible for (1) selecting the appropriate TI products for your application, (2) designing, validating and testing your application, and (3) ensuring your application meets applicable standards, and any other safety, security, regulatory or other requirements.

These resources are subject to change without notice. TI grants you permission to use these resources only for development of an application that uses the TI products described in the resource. Other reproduction and display of these resources is prohibited. No license is granted to any other TI intellectual property right or to any third party intellectual property right. TI disclaims responsibility for, and you fully indemnify TI and its representatives against any claims, damages, costs, losses, and liabilities arising out of your use of these resources.

TI's products are provided subject to [TI's Terms of Sale](#), [TI's General Quality Guidelines](#), or other applicable terms available either on [ti.com](#) or provided in conjunction with such TI products. TI's provision of these resources does not expand or otherwise alter TI's applicable warranties or warranty disclaimers for TI products. Unless TI explicitly designates a product as custom or customer-specified, TI products are standard, catalog, general purpose devices.

TI objects to and rejects any additional or different terms you may propose.

Copyright © 2025, Texas Instruments Incorporated

Last updated 10/2025