

CSD18535KTT 60V N-Channel NexFET™ Power MOSFET

1 Features

- Ultralow Q_g and Q_{gd}
- Low thermal resistance
- Avalanche rated
- Pb-free terminal plating
- RoHS compliant
- Halogen free
- D²PAK plastic package

2 Applications

- Secondary side synchronous rectifier
- Motor control

Description

This 60V, 1.6mΩ, D²PAK (TO-263) NexFET™ power MOSFET is designed to minimize losses in power conversion applications.

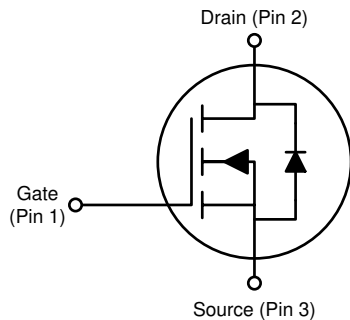

Product Summary

$T_A = 25^\circ\text{C}$		TYPICAL VALUE		UNIT
V_{DS}	Drain-to-Source Voltage	60		V
Q_g	Gate Charge Total (10V)	63		nC
Q_{gd}	Gate Charge Gate-to-Drain	10.4		nC
$R_{DS(on)}$	Drain-to-Source On-Resistance	$V_{GS} = 4.5\text{V}$	2.3	mΩ
		$V_{GS} = 10\text{V}$	1.6	mΩ
$V_{GS(th)}$	Threshold Voltage	1.9		V

Ordering Information (1)

DEVICE	QTY	MEDIA	PACKAGE	SHIP
CSD18535KTT	500	13-Inch Reel	D ² PAK Plastic Package	Tape & Reel
CSD18535KTTT	50			

- (1) For all available packages, see the orderable addendum at the end of the data sheet.

Absolute Maximum Ratings

$T_A = 25^\circ\text{C}$		VALUE	UNIT
V_{DS}	Drain-to-Source Voltage	60	V
V_{GS}	Gate-to-Source Voltage	±20	V
I_D	Continuous Drain Current (Package limited)	200	A
	Continuous Drain Current (Silicon limited), $T_C = 25^\circ\text{C}$	279	A
	Continuous Drain Current (Silicon limited), $T_C = 100^\circ\text{C}$	197	A
I_{DM}	Pulsed Drain Current (1)	400	A
P_D	Power Dissipation	300	W
T_J, T_{stg}	Operating Junction and Storage Temperature	-55 to 175	°C
E_{AS}	Avalanche Energy, Single Pulse $I_D = 111\text{A}, L = 0.1\text{mH}, R_G = 25\Omega$	616	mJ

- (1) Max $R_{\theta JC} = 0.5^\circ\text{C/W}$, pulse duration $\leq 100\mu\text{s}$, duty cycle $\leq 1\%$

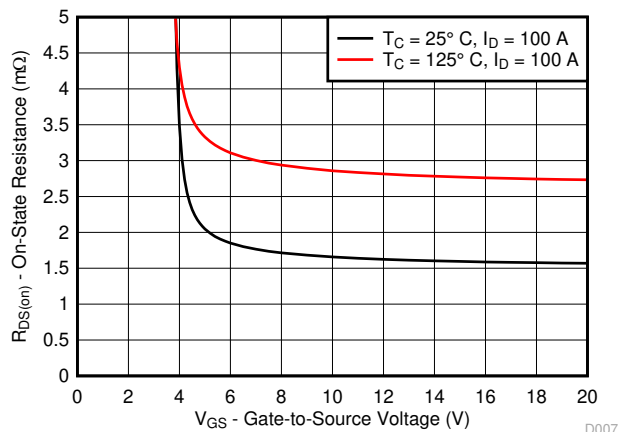

$R_{DS(on)}$ vs V_{GS}

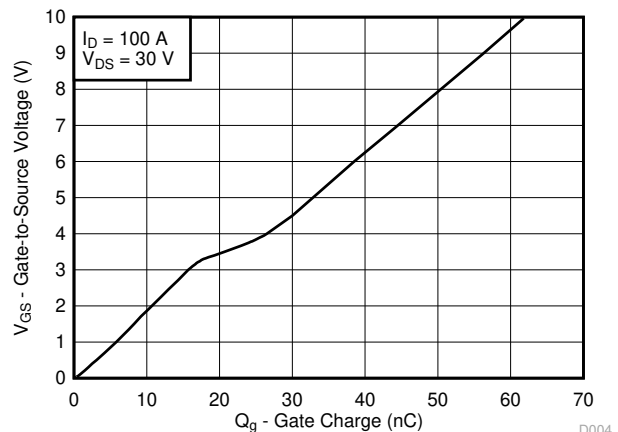

Gate Charge



Table of Contents

1 Features	1	4.2 Receiving Notification of Documentation Updates.....	7
2 Applications	1	4.3 Support Resources.....	7
3 Specifications	3	4.4 Trademarks.....	7
3.1 Electrical Characteristics.....	3	4.5 Electrostatic Discharge Caution.....	7
3.2 Thermal Information.....	3	4.6 Glossary.....	7
3.3 Typical MOSFET Characteristics.....	4	5 Revision History	7
4 Device and Documentation Support	7	6 Mechanical, Packaging, and Orderable Information	8
4.1 Third-Party Products Disclaimer.....	7		

3 Specifications

3.1 Electrical Characteristics

($T_A = 25^\circ\text{C}$ unless otherwise stated)

PARAMETER		TEST CONDITIONS	MIN	TYP	MAX	UNIT
STATIC CHARACTERISTICS						
V_{DSS}	Drain-to-source voltage	$V_{GS} = 0V, I_D = 250\mu A$	60			V
I_{DSS}	Drain-to-source leakage current	$V_{GS} = 0V, V_{DS} = 48V$			1	μA
I_{GSS}	Gate-to-source leakage current	$V_{DS} = 0V, V_{GS} = 20V$			100	nA
$V_{GS(th)}$	Gate-to-source threshold voltage	$V_{DS} = V_{GS}, I_D = 250\mu A$	1.4	1.9	2.4	V
$R_{DS(on)}$	Drain-to-source on-resistance	$V_{GS} = 4.5V, I_D = 100A$		2.3	2.9	m Ω
		$V_{GS} = 10V, I_D = 100A$		1.6	2.0	m Ω
g_{fs}	Transconductance	$V_{DS} = 6V, I_D = 100A$		263		S
DYNAMIC CHARACTERISTICS						
C_{iss}	Input capacitance	$V_{GS} = 0V, V_{DS} = 30V, f = 1\text{ MHz}$		5090	6620	pF
C_{oss}	Output capacitance			890	1150	pF
C_{riss}	Reverse transfer capacitance			24	31	pF
R_G	Series gate resistance			0.8	1.6	Ω
Q_g	Gate charge total (10V)	$V_{DS} = 30V, I_D = 100A$		63	81	nC
Q_{gd}	Gate charge gate-to-drain			10.4		nC
Q_{gs}	Gate charge gate-to-source			15.7		nC
$Q_{g(th)}$	Gate charge at V_{th}			9.4		nC
Q_{oss}	Output charge	$V_{DS} = 30V, V_{GS} = 0V$		140		nC
$t_{d(on)}$	Turn on delay time	$V_{DS} = 30V, V_{GS} = 10V,$ $I_{DS} = 100A, R_G = 0\Omega$		9		ns
t_r	Rise time			3		ns
$t_{d(off)}$	Turn off delay time			19		ns
t_f	Fall time			3		ns
DIODE CHARACTERISTICS						
V_{SD}	Diode forward voltage	$I_{SD} = 100A, V_{GS} = 0V$		0.9	1.0	V
Q_{rr}	Reverse recovery charge	$V_{DS} = 30V, I_F = 100A,$ $di/dt = 300A/\mu s$		214		nC
t_{rr}	Reverse recovery time			63		ns

3.2 Thermal Information

($T_A = 25^\circ\text{C}$ unless otherwise stated)

THERMAL METRIC		MIN	TYP	MAX	UNIT
$R_{\theta JC}$	Junction-to-case thermal resistance			0.5	$^\circ\text{C/W}$
$R_{\theta JA}$	Junction-to-ambient thermal resistance			62	$^\circ\text{C/W}$

3.3 Typical MOSFET Characteristics

($T_A = 25^\circ\text{C}$ unless otherwise stated)

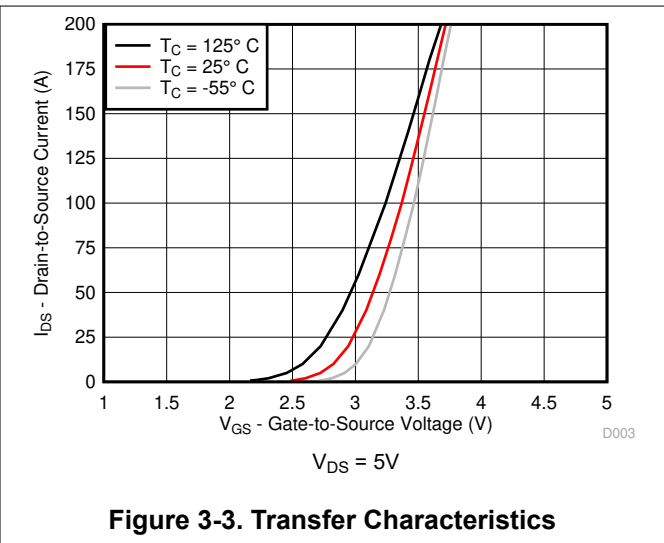
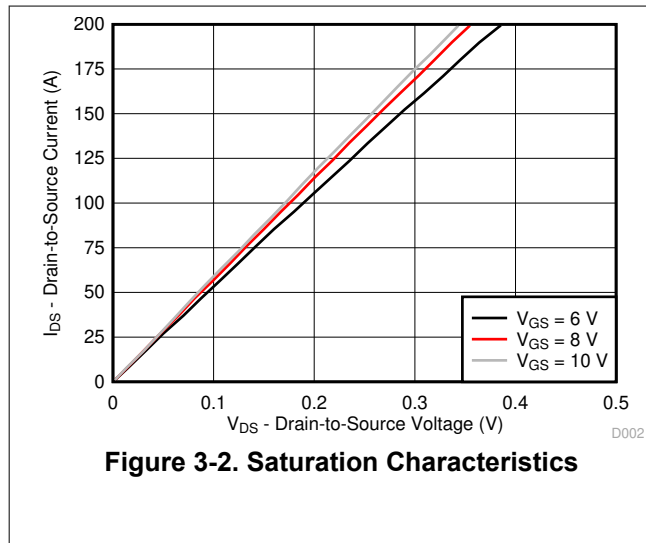
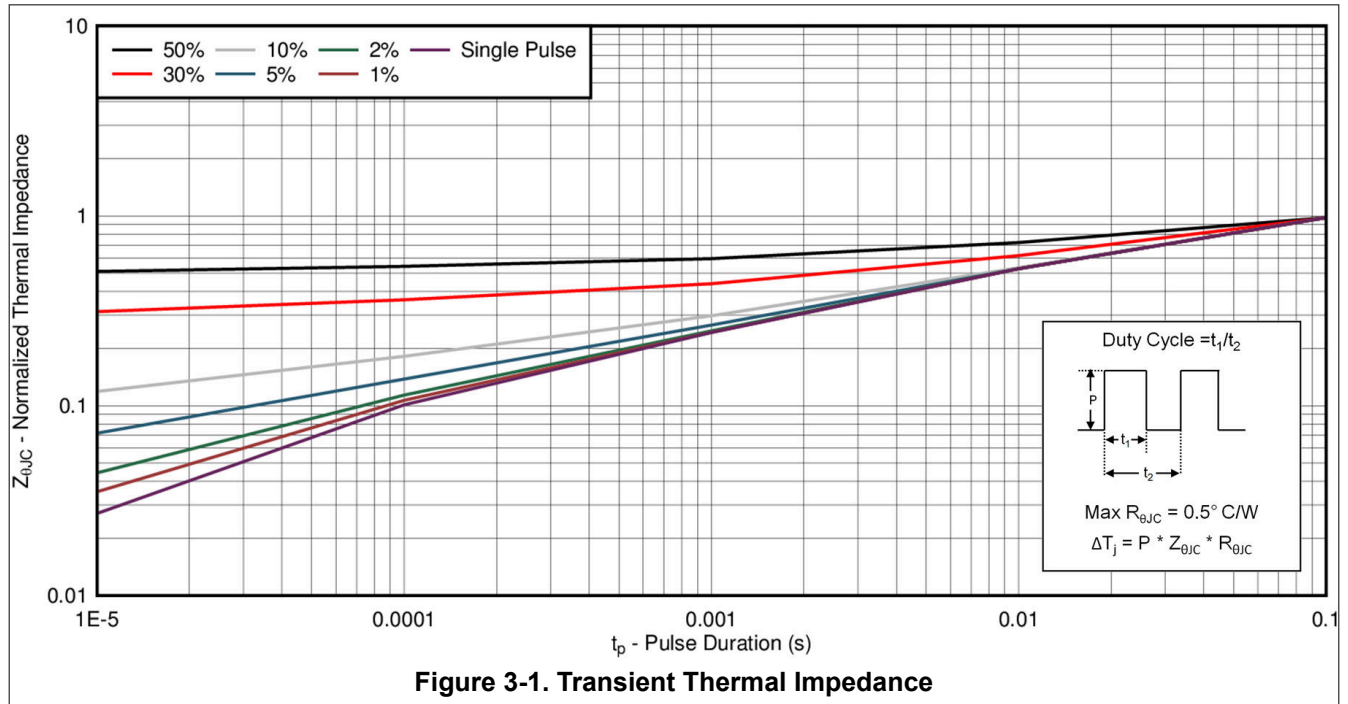

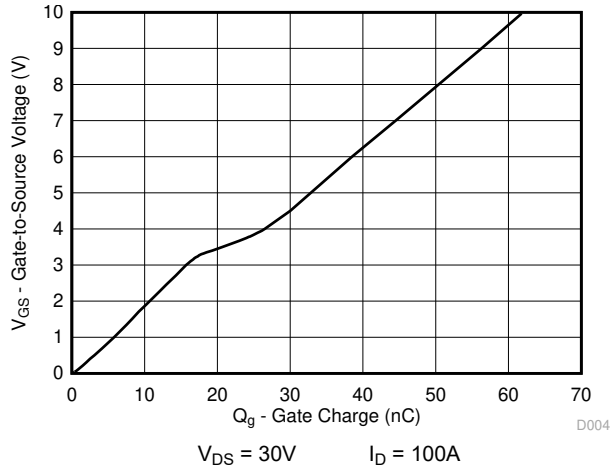

Figure 3-4. Gate Charge

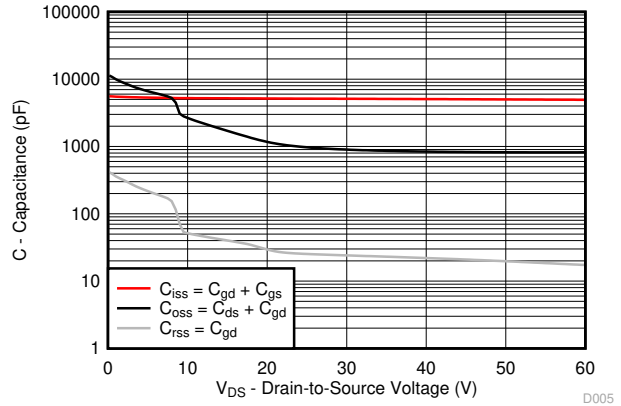

Figure 3-5. Capacitance

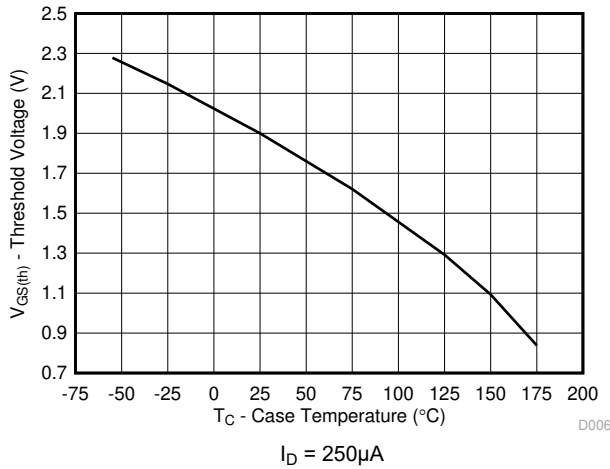

Figure 3-6. Threshold Voltage vs Temperature

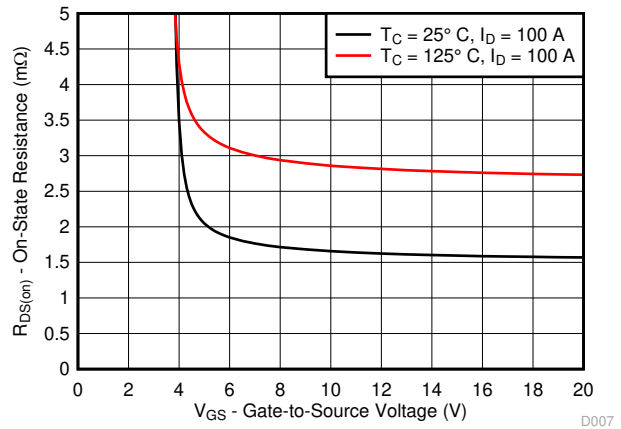

Figure 3-7. On-State Resistance vs Gate-to-Source Voltage

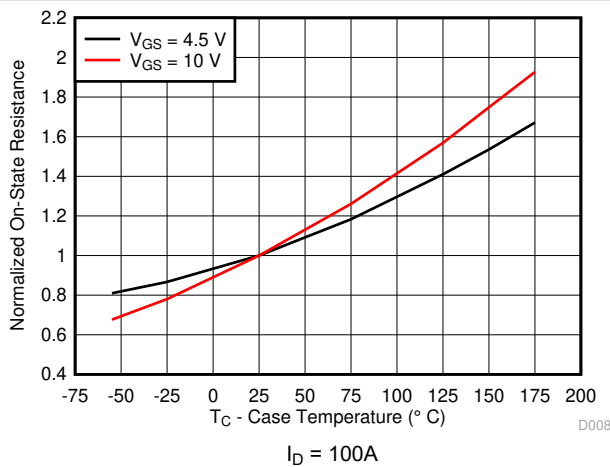

Figure 3-8. Normalized On-State Resistance vs Temperature

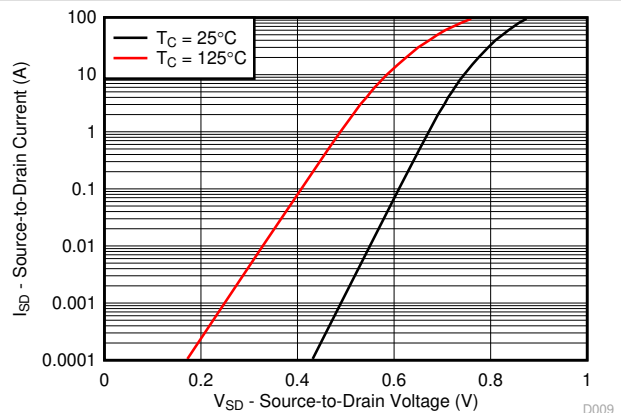

Figure 3-9. Typical Diode Forward Voltage

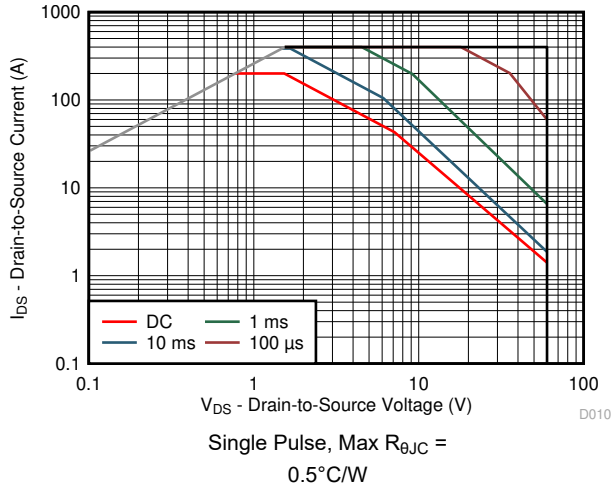

Figure 3-10. Maximum Safe Operating Area

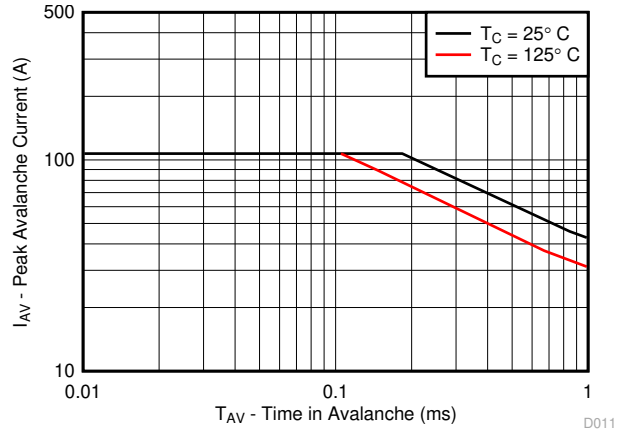

Figure 3-11. Single Pulse Unclamped Inductive Switching

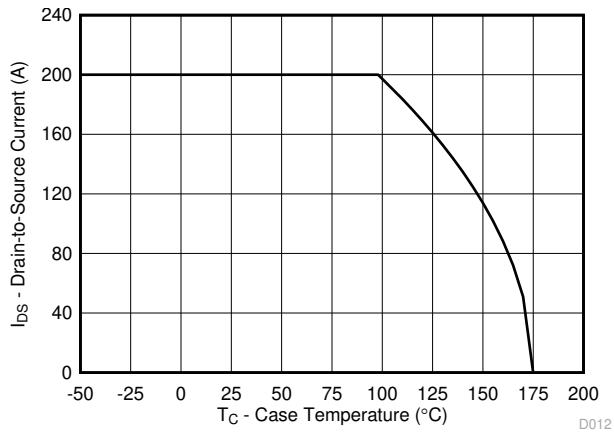

Figure 3-12. Maximum Drain Current vs Temperature

4 Device and Documentation Support

4.1 Third-Party Products Disclaimer

TI'S PUBLICATION OF INFORMATION REGARDING THIRD-PARTY PRODUCTS OR SERVICES DOES NOT CONSTITUTE AN ENDORSEMENT REGARDING THE SUITABILITY OF SUCH PRODUCTS OR SERVICES OR A WARRANTY, REPRESENTATION OR ENDORSEMENT OF SUCH PRODUCTS OR SERVICES, EITHER ALONE OR IN COMBINATION WITH ANY TI PRODUCT OR SERVICE.

4.2 Receiving Notification of Documentation Updates

To receive notification of documentation updates, navigate to the device product folder on ti.com. Click on *Notifications* to register and receive a weekly digest of any product information that has changed. For change details, review the revision history included in any revised document.

4.3 Support Resources

[TI E2E™ support forums](#) are an engineer's go-to source for fast, verified answers and design help — straight from the experts. Search existing answers or ask your own question to get the quick design help you need.

Linked content is provided "AS IS" by the respective contributors. They do not constitute TI specifications and do not necessarily reflect TI's views; see TI's [Terms of Use](#).

4.4 Trademarks

NexFET™ is a trademark of Texas Instruments.

TI E2E™ is a trademark of Texas Instruments.

All trademarks are the property of their respective owners.

4.5 Electrostatic Discharge Caution



This integrated circuit can be damaged by ESD. Texas Instruments recommends that all integrated circuits be handled with appropriate precautions. Failure to observe proper handling and installation procedures can cause damage.

ESD damage can range from subtle performance degradation to complete device failure. Precision integrated circuits may be more susceptible to damage because very small parametric changes could cause the device not to meet its published specifications.

4.6 Glossary

[TI Glossary](#) This glossary lists and explains terms, acronyms, and definitions.

5 Revision History

Changes from Revision * (March 2016) to Revision A (June 2025)	Page
• Updated the numbering format for tables, figures, and cross-references throughout the document.....	1

6 Mechanical, Packaging, and Orderable Information

The following pages include mechanical, packaging, and orderable information. This information is the most current data available for the designated devices. This data is subject to change without notice and revision of this document. For browser-based versions of this data sheet, refer to the left-hand navigation.

PACKAGING INFORMATION

Orderable part number	Status (1)	Material type (2)	Package Pins	Package qty Carrier	RoHS (3)	Lead finish/ Ball material (4)	MSL rating/ Peak reflow (5)	Op temp (°C)	Part marking (6)
CSD18535KTT	Active	Production	DDPAK/ TO-263 (KTT) 2	500 LARGE T&R	ROHS Exempt	SN	Level-2-260C-1 YEAR	-55 to 175	CSD18535KTT
CSD18535KTT.B	Active	Production	DDPAK/ TO-263 (KTT) 2	500 LARGE T&R	ROHS Exempt	SN	Level-2-260C-1 YEAR	-55 to 175	CSD18535KTT
CSD18535KTTT	Active	Production	DDPAK/ TO-263 (KTT) 2	50 SMALL T&R	ROHS Exempt	SN	Level-2-260C-1 YEAR	-55 to 175	CSD18535KTT
CSD18535KTTT.B	Active	Production	DDPAK/ TO-263 (KTT) 2	50 SMALL T&R	ROHS Exempt	SN	Level-2-260C-1 YEAR	-55 to 175	CSD18535KTT

(1) **Status:** For more details on status, see our [product life cycle](#).

(2) **Material type:** When designated, preproduction parts are prototypes/experimental devices, and are not yet approved or released for full production. Testing and final process, including without limitation quality assurance, reliability performance testing, and/or process qualification, may not yet be complete, and this item is subject to further changes or possible discontinuation. If available for ordering, purchases will be subject to an additional waiver at checkout, and are intended for early internal evaluation purposes only. These items are sold without warranties of any kind.

(3) **RoHS values:** Yes, No, RoHS Exempt. See the [TI RoHS Statement](#) for additional information and value definition.

(4) **Lead finish/Ball material:** Parts may have multiple material finish options. Finish options are separated by a vertical ruled line. Lead finish/Ball material values may wrap to two lines if the finish value exceeds the maximum column width.

(5) **MSL rating/Peak reflow:** The moisture sensitivity level ratings and peak solder (reflow) temperatures. In the event that a part has multiple moisture sensitivity ratings, only the lowest level per JEDEC standards is shown. Refer to the shipping label for the actual reflow temperature that will be used to mount the part to the printed circuit board.

(6) **Part marking:** There may be an additional marking, which relates to the logo, the lot trace code information, or the environmental category of the part.

Multiple part markings will be inside parentheses. Only one part marking contained in parentheses and separated by a "-" will appear on a part. If a line is indented then it is a continuation of the previous line and the two combined represent the entire part marking for that device.

Important Information and Disclaimer: The information provided on this page represents TI's knowledge and belief as of the date that it is provided. TI bases its knowledge and belief on information provided by third parties, and makes no representation or warranty as to the accuracy of such information. Efforts are underway to better integrate information from third parties. TI has taken and continues to take reasonable steps to provide representative and accurate information but may not have conducted destructive testing or chemical analysis on incoming materials and chemicals. TI and TI suppliers consider certain information to be proprietary, and thus CAS numbers and other limited information may not be available for release.

In no event shall TI's liability arising out of such information exceed the total purchase price of the TI part(s) at issue in this document sold by TI to Customer on an annual basis.

TAPE AND REEL INFORMATION

QUADRANT ASSIGNMENTS FOR PIN 1 ORIENTATION IN TAPE

*All dimensions are nominal

Device	Package Type	Package Drawing	Pins	SPQ	Reel Diameter (mm)	Reel Width W1 (mm)	A0 (mm)	B0 (mm)	K0 (mm)	P1 (mm)	W (mm)	Pin1 Quadrant
CSD18535KTT	DDPAK/ TO-263	KTT	2	500	330.0	24.4	10.8	16.3	5.11	16.0	24.0	Q2
CSD18535KTTT	DDPAK/ TO-263	KTT	2	50	330.0	24.4	10.8	16.3	5.11	16.0	24.0	Q2

TAPE AND REEL BOX DIMENSIONS

*All dimensions are nominal

Device	Package Type	Package Drawing	Pins	SPQ	Length (mm)	Width (mm)	Height (mm)
CSD18535KTT	DDPAK/TO-263	KTT	2	500	340.0	340.0	38.0
CSD18535KTTT	DDPAK/TO-263	KTT	2	50	340.0	340.0	38.0

KTT0002A

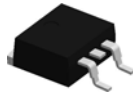

PACKAGE OUTLINE

TO-263 - 4.7 mm max height

TRANSISTOR OUTLINE

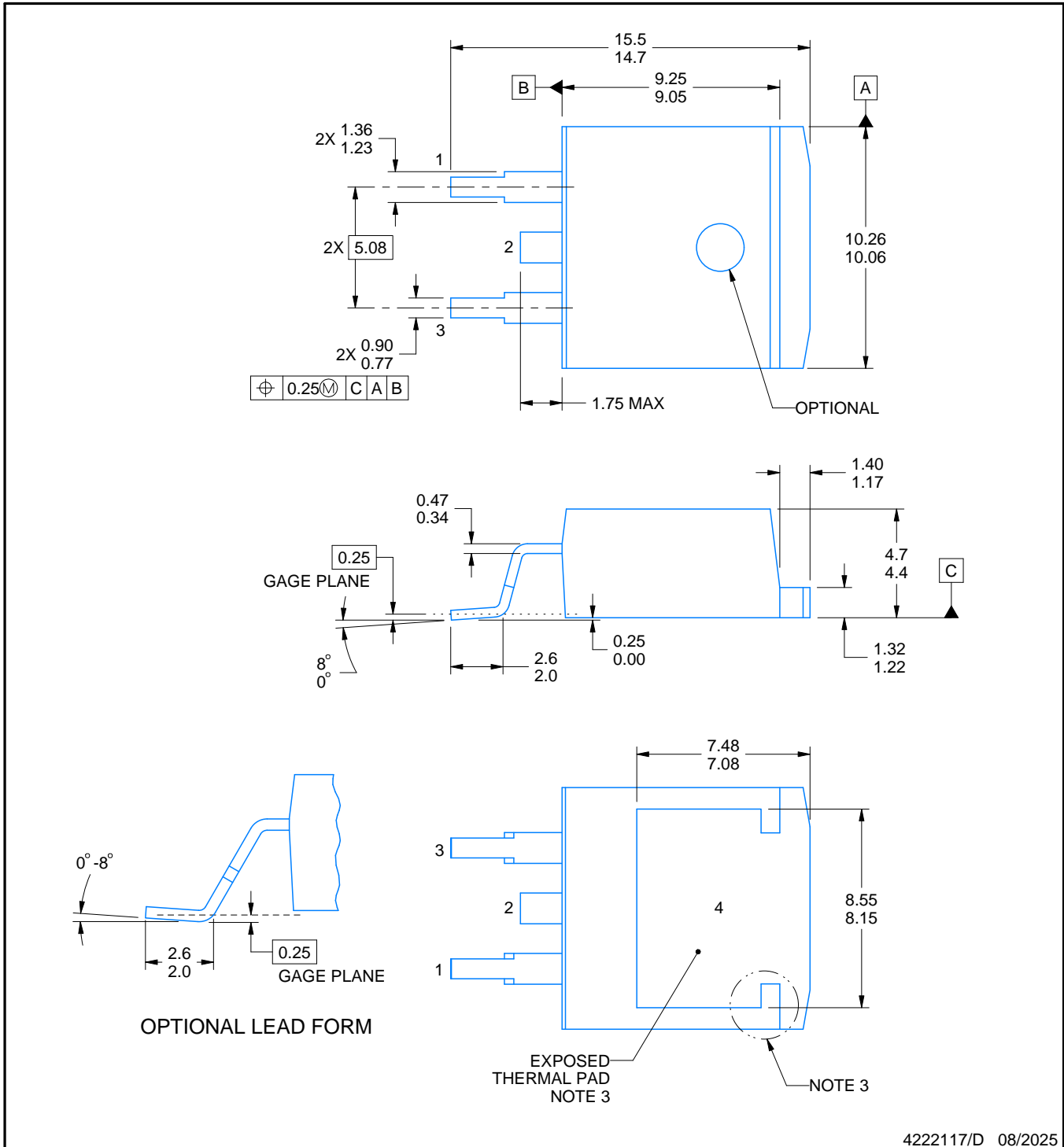

4222117/D 08/2025

NOTES:

1. All linear dimensions are in millimeters. Any dimensions in parenthesis are for reference only. Dimensioning and tolerancing per ASME Y14.5M.
2. This drawing is subject to change without notice.
3. Features may not exist and shape may vary per different assembly sites. Pin 2 and Pin 4 connected.
4. Reference JEDEC registration TO-263.

EXAMPLE BOARD LAYOUT

KTT0002A

TO-263 - 4.7 mm max height

TRANSISTOR OUTLINE

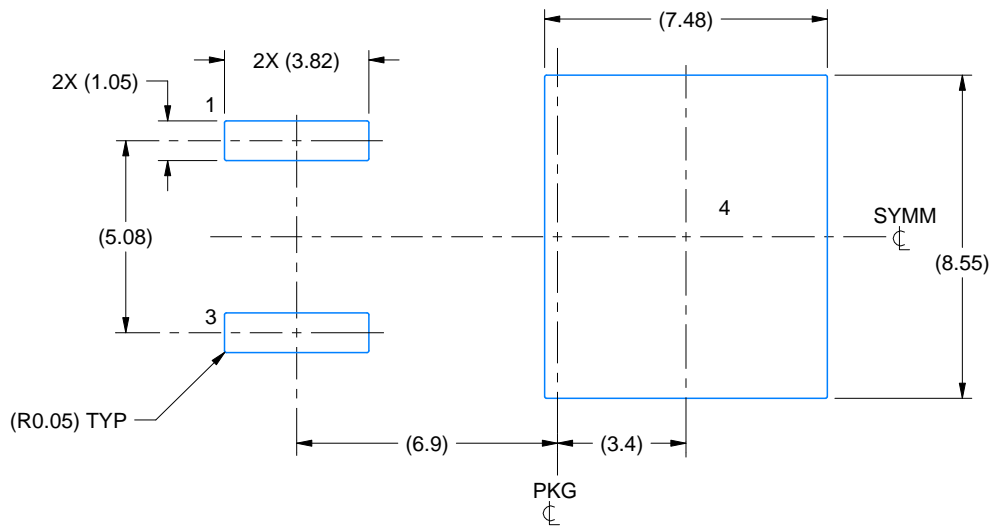

LAND PATTERN EXAMPLE
EXPOSED METAL SHOWN
SCALE:5X

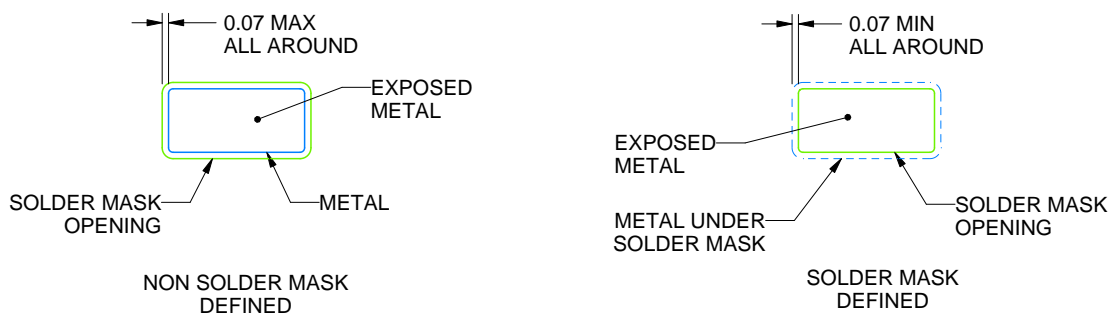

SOLDER MASK DETAILS

4222117/D 08/2025

NOTES: (continued)

5. This package is designed to be soldered to a thermal pad on the board. For more information, see Texas Instruments literature numbers SLMA002 (www.ti.com/lit/slm002) and SLMA004 (www.ti.com/lit/slma004).
6. Vias are optional depending on application, refer to device data sheet. It is recommended that vias under paste be filled, plugged or tented.

EXAMPLE STENCIL DESIGN

KTT0002A

TO-263 - 4.7 mm max height

TRANSISTOR OUTLINE

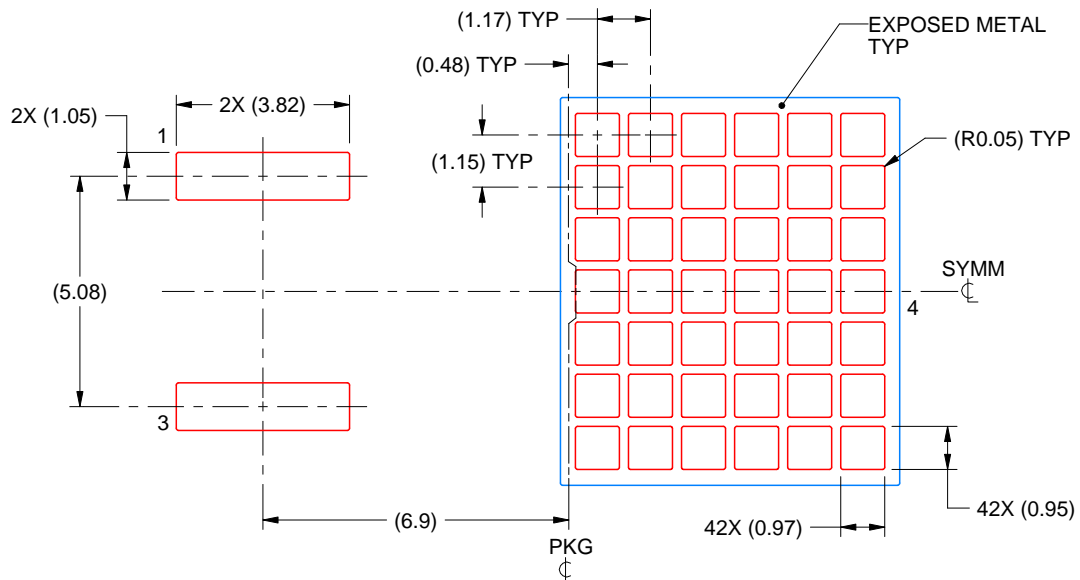

SOLDER PASTE EXAMPLE
BASED ON 0.125 mm THICK STENCIL

EXPOSED PAD
60.5% PRINTED SOLDER COVERAGE BY AREA
SCALE:6X

4222117/D 08/2025

NOTES: (continued)

7. Laser cutting apertures with trapezoidal walls and rounded corners may offer better paste release. IPC-7525 may have alternate design recommendations.
8. Board assembly site may have different recommendations for stencil design.

IMPORTANT NOTICE AND DISCLAIMER

TI PROVIDES TECHNICAL AND RELIABILITY DATA (INCLUDING DATASHEETS), DESIGN RESOURCES (INCLUDING REFERENCE DESIGNS), APPLICATION OR OTHER DESIGN ADVICE, WEB TOOLS, SAFETY INFORMATION, AND OTHER RESOURCES "AS IS" AND WITH ALL FAULTS, AND DISCLAIMS ALL WARRANTIES, EXPRESS AND IMPLIED, INCLUDING WITHOUT LIMITATION ANY IMPLIED WARRANTIES OF MERCHANTABILITY, FITNESS FOR A PARTICULAR PURPOSE OR NON-INFRINGEMENT OF THIRD PARTY INTELLECTUAL PROPERTY RIGHTS.

These resources are intended for skilled developers designing with TI products. You are solely responsible for (1) selecting the appropriate TI products for your application, (2) designing, validating and testing your application, and (3) ensuring your application meets applicable standards, and any other safety, security, regulatory or other requirements.

These resources are subject to change without notice. TI grants you permission to use these resources only for development of an application that uses the TI products described in the resource. Other reproduction and display of these resources is prohibited. No license is granted to any other TI intellectual property right or to any third party intellectual property right. TI disclaims responsibility for, and you fully indemnify TI and its representatives against any claims, damages, costs, losses, and liabilities arising out of your use of these resources.

TI's products are provided subject to [TI's Terms of Sale](#), [TI's General Quality Guidelines](#), or other applicable terms available either on [ti.com](#) or provided in conjunction with such TI products. TI's provision of these resources does not expand or otherwise alter TI's applicable warranties or warranty disclaimers for TI products. Unless TI explicitly designates a product as custom or customer-specified, TI products are standard, catalog, general purpose devices.

TI objects to and rejects any additional or different terms you may propose.

Copyright © 2025, Texas Instruments Incorporated

Last updated 10/2025