

# DACx3608 Octal, 10-Bit or 8-Bit, I<sup>2</sup>C™ Interface, Buffered Voltage Output DACs in Tiny 3 × 3 WQFN Package

## 1 Features

- $\pm 1$ -LSB INL and DNL
- Wide Operating Range
  - Power Supply: 1.8 V to 5.5 V
  - Temperature Range:  $-40^{\circ}\text{C}$  to  $125^{\circ}\text{C}$
- I<sup>2</sup>C™ Serial Interface
  - Standard, Fast, and Fast+ Mode
  - 2.4-V, V<sub>IH</sub> with V<sub>DD</sub> = 5.5 V
- $\overline{\text{LDAC}}$  Pin For Simultaneous Output Update
- Very Low Power: 0.1 mA/Channel at 1.8 V
- Low Power Startup Mode: Outputs powered down to 10K State
- Tiny Package
  - 16-Pin WQFN (3 mm × 3 mm)

## 2 Applications

- Programmable Power Supplies
- Programmable Window Comparator
- VCOM Biasing in Display Panel
- Laser Driver In Multifunction Printers
- Auto Focus Digital Still Cameras Lens
- ATM Machines, Currency Counters, Barcode Readers
- IP Network Cameras, Projectors

## 3 Description

The DAC53608 and DAC43608 (DACx3608) are low-power, eight-channel, voltage-output, 10-bit or 8-bit digital-to-analog converters (DACs) respectively. The DACx3608 are specified monotonic by design across a wide power supply range from 1.8 V to 5.5 V. Using an external reference, the DACx3608 provides a full scale output voltage range of 1.8 V to 5.5 V while consuming 0.1-mA quiescent current per channel. The DACx3608 also includes per channel, user programmable, power down registers. These registers facilitate the DAC output buffers to start in a power down to 10K state and remain in this state until a power up command is issued to these output buffers.

Low quiescent current, wide power supply range, and per channel power down option makes DACx3608 ideal for low power, battery operated systems.

The devices communicate through the I<sup>2</sup>C™ interface. These devices support I<sup>2</sup>C™ standard mode (100 kbps), fast mode (400 kbps), and fast+ mode (1 Mbps). These devices also have a load DAC (LDAC) pin that allows simultaneous DAC updates.

The DACx3608 are available in small 3-mm × 3-mm, 16-pin WQFN package. The devices are fully specified over the extended industrial temperature range of  $-40^{\circ}\text{C}$  to  $+125^{\circ}\text{C}$ .

### Device Information<sup>(1)</sup>

PART NUMBER	PACKAGE	BODY SIZE (NOM)
DAC53608	WQFN (16)	3.00 mm × 3.00 mm
DAC43608	WQFN (16)	3.00 mm × 3.00 mm

(1) For all available packages, refer to the orderable addendum at the end of the data sheet.

### Simplified Block Diagram

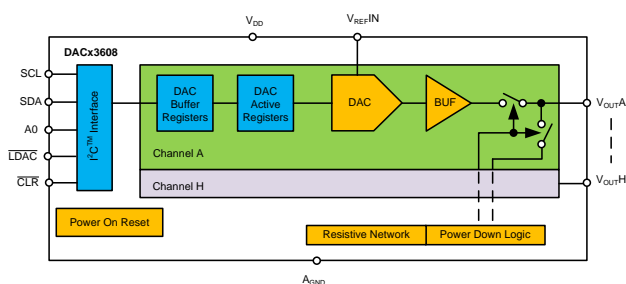

### Programmable Window Comparator

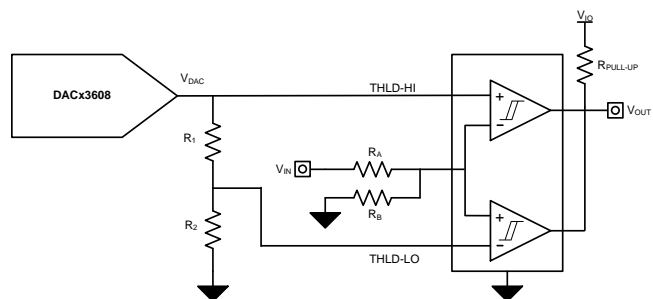

## Table of Contents

<b>1 Features</b> .....	<b>1</b>	8.2 Functional Block Diagram .....	<b>19</b>
<b>2 Applications</b> .....	<b>1</b>	8.3 Feature Description .....	<b>20</b>
<b>3 Description</b> .....	<b>1</b>	8.4 Device Functional Modes .....	<b>21</b>
<b>4 Revision History</b> .....	<b>2</b>	8.5 Programming .....	<b>22</b>
<b>5 Device Comparison Table</b> .....	<b>3</b>	8.6 Register Map .....	<b>28</b>
<b>6 Pin Configurations and Functions</b> .....	<b>3</b>	<b>9 Application and Implementation</b> .....	<b>31</b>
<b>7 Specifications</b> .....	<b>4</b>	9.1 Application Information .....	<b>31</b>
7.1 Absolute Maximum Ratings .....	<b>4</b>	9.2 Typical Applications .....	<b>31</b>
7.2 ESD Ratings .....	<b>4</b>	<b>10 Power Supply Recommendations</b> .....	<b>34</b>
7.3 Recommended Operating Conditions .....	<b>4</b>	<b>11 Layout</b> .....	<b>35</b>
7.4 Thermal Information .....	<b>4</b>	11.1 Layout Guidelines .....	<b>35</b>
7.5 Electrical Characteristics .....	<b>5</b>	11.2 Layout Example .....	<b>35</b>
7.6 Timing Requirements: I <sup>2</sup> C™ Standard Mode .....	<b>7</b>	<b>12 Device and Documentation Support</b> .....	<b>36</b>
7.7 Timing Requirements: I <sup>2</sup> C™ Fast Mode .....	<b>7</b>	12.1 Documentation Support .....	<b>36</b>
7.8 Timing Requirements: I <sup>2</sup> C™ Fast+ Mode .....	<b>8</b>	12.2 Related Links .....	<b>36</b>
7.9 Timing Requirements: Logic .....	<b>8</b>	12.3 Receiving Notification of Documentation Updates .....	<b>36</b>
7.10 Typical Characteristics: 1.8 V .....	<b>10</b>	12.4 Community Resources .....	<b>36</b>
7.11 Typical Characteristics: 5.5 V .....	<b>12</b>	12.5 Trademarks .....	<b>36</b>
7.12 Typical Characteristics .....	<b>17</b>	12.6 Electrostatic Discharge Caution .....	<b>36</b>
7.13 Typical Characteristics .....	<b>18</b>	12.7 Glossary .....	<b>36</b>
<b>8 Detailed Description</b> .....	<b>19</b>	<b>13 Mechanical, Packaging, and Orderable Information</b> .....	<b>37</b>
8.1 Overview .....	<b>19</b>		

## 4 Revision History

Changes from Original (October 2018) to Revision A	Page
• Changed from Advance Information to Production Data .....	<b>1</b>

## 5 Device Comparison Table

DEVICE	RESOLUTION
DAC53608	10-Bit
DAC43608	8-Bit

## 6 Pin Configurations and Functions

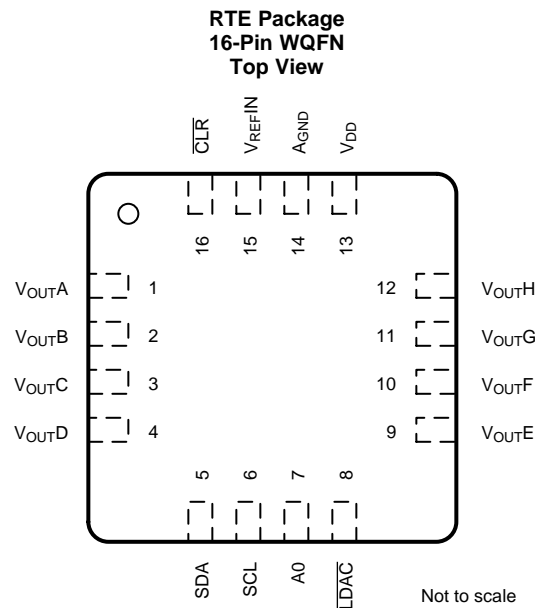

### Pin Functions

PIN		I/O	DESCRIPTION
NAME	NO.		
A0	7	I	Four-state address input
AGND	14	GND	Ground reference point for all circuitry on the device.
CLR	16	I	Asynchronous clear pin (active low)
LDAC	8	I	Load DAC pin for simultaneous output update (active low)
SCL	6	I	Serial interface clock
SDA	5	I/O	Data is clocked into or out of the input register. This pin is a bidirectional, open drain data line that must be connected to the supply voltage with an external pull-up resistor.
VDD	13	PWR	Analog supply voltage (1.8 V to 5.5 V).
VOUTA	1	O	Analog output voltage from DAC A
VOUTB	2	O	Analog output voltage from DAC B
VOUTC	3	O	Analog output voltage from DAC C
VOUTD	4	O	Analog output voltage from DAC D
VOUTE	9	O	Analog output voltage from DAC E
VOUTF	10	O	Analog output voltage from DAC F
VOUTG	11	O	Analog output voltage from DAC G
VOUTH	12	O	Analog output voltage from DAC H
VREFIN	15	I/O	Reference input to the device

## 7 Specifications

### 7.1 Absolute Maximum Ratings

over operating free-air temperature range (unless otherwise noted)<sup>(1)</sup>

		MIN	MAX	UNIT
Input voltage	V <sub>DD</sub> to A <sub>GND</sub>	-0.3	6	V
	V <sub>REFIN</sub> to A <sub>GND</sub>	-0.3	V <sub>DD</sub> + 0.3	
	Digital input(s) to A <sub>GND</sub>	-0.3	V <sub>DD</sub> + 0.3	
Output voltage	V <sub>OUT</sub> to A <sub>GND</sub>	-0.3	V <sub>DD</sub> + 0.3	V
Input Current	Current into any pin	-10	10	mA
Temperature	Junction temperature, T <sub>J</sub>	-40	150	°C
	Storage temperature, T <sub>stg</sub>	-65	150	

- (1) Stresses beyond those listed under *Absolute Maximum Rating* may cause permanent damage to the device. These are stress ratings only, which do not imply functional operation of the device at these or any other conditions beyond those indicated under *Recommended Operating Condition*. Exposure to absolute-maximum-rated conditions for extended periods may affect device reliability.

### 7.2 ESD Ratings

			VALUE	UNIT
V <sub>(ESD)</sub>	Electrostatic discharge	Human body model (HBM), per ANSI/ESDA/JEDEC JS-001, all pins <sup>(1)</sup>	±1000	V
		Charged device model (CDM), per JEDEC specification JESD22-C101, all pins <sup>(2)</sup>	±500	

- (1) JEDEC document JEP155 states that 500-V HBM allows safe manufacturing with a standard ESD control process. [Following sentence optional; see the wiki.] Manufacturing with less than 500-V HBM is possible with the necessary precautions. [Following sentence optional; see the wiki.] Pins listed as ±V<sub>WWW</sub> V and/or ±XXX V may actually have higher performance.
- (2) JEDEC document JEP157 states that 250-V CDM allows safe manufacturing with a standard ESD control process. [Following sentence optional; see the wiki.] Manufacturing with less than 250-V CDM is possible with the necessary precautions. [Following sentence optional; see the wiki.] Pins listed as ±YYY V and/or ±ZZZ V may actually have higher performance.

### 7.3 Recommended Operating Conditions

over operating free-air temperature range (unless otherwise noted)

		MIN	NOM	MAX	UNIT
V <sub>DD</sub> to A <sub>GND</sub>	Positive supply voltage to ground	1.8		5.5	V
V <sub>REFIN</sub> to A <sub>GND</sub>	Reference input supply voltage to ground	1.8		V <sub>DD</sub>	V
V <sub>IH</sub>	Digital input high voltage, 1.8 ≤ V <sub>DD</sub> ≤ 2.7	V <sub>DD</sub> - 0.3			V
V <sub>IH</sub>	Digital input high voltage, 2.7 < V <sub>DD</sub> ≤ 5.5	2.4			V
V <sub>IL</sub>	Digital input low voltage			0.5	V
T <sub>A</sub>	Ambient temperature	-40		125	°C

### 7.4 Thermal Information

THERMAL METRIC <sup>(1)</sup>		DACx3608	UNIT
		RTE (WQFN)	
		16 PIN	
R <sub>θJA</sub>	Junction-to-ambient thermal resistance	49	°C/W
R <sub>θJC(top)</sub>	Junction-to-case (top) thermal resistance	50	°C/W
R <sub>θJB</sub>	Junction-to-board thermal resistance	24.1	°C/W
Ψ <sub>JT</sub>	Junction-to-top characterization parameter	1.1	°C/W
Y <sub>JB</sub>	Junction-to-board characterization parameter	24.1	°C/W
R <sub>θJC(bot)</sub>	Junction-to-case (bottom) thermal resistance	8.7	°C/W

- (1) For more information about traditional and new thermal metrics, see the [Semiconductor and IC Package Thermal Metrics application report](#).

## 7.5 Electrical Characteristics

all minimum/maximum specifications at  $T_A = -40^\circ\text{C}$  to  $+125^\circ\text{C}$  and all typical specification at  $T_A = 25^\circ\text{C}$ ,  $1.8\text{ V} \leq V_{DD} \leq 5.5\text{ V}$ ,  $V_{REFIN} = 2.5\text{ V}$  for  $V_{DD} \geq 2.7\text{ V}$ ,  $V_{REFIN} = 1.8\text{ V}$  for  $V_{DD} \leq 2.7\text{ V}$ ,  $R_L = 5\text{ k}\Omega$  to  $A_{GND}$ ,  $C_L = 200\text{ pF}$  to  $A_{GND}$ , and digital inputs at  $V_{DD}$  or  $A_{GND}$  (unless otherwise noted)

PARAMETER		TEST CONDITIONS	MIN	TYP	MAX	UNIT
<b>STATIC PERFORMANCE</b>						
	Resolution	DAC53608	10			Bits
		DAC43608	8			
INL	Relative accuracy <sup>(1)</sup>	DAC43608, $2.7\text{ V} \leq V_{DD} \leq 5.5\text{ V}$	-1		1	LSB
		DAC43608, $1.8\text{ V} \leq V_{DD} \leq 2.7\text{ V}$	-1		1	
		DAC53608, $2.7\text{ V} \leq V_{DD} \leq 5.5\text{ V}$	-1		1	
		DAC53608, $1.8\text{ V} \leq V_{DD} \leq 2.7\text{ V}$	-1		1	
DNL	Differential nonlinearity <sup>(1)</sup>	DAC43608, $2.7\text{ V} \leq V_{DD} \leq 5.5\text{ V}$	-1		1	LSB
		DAC43608, $1.8\text{ V} \leq V_{DD} \leq 2.7\text{ V}$	-1		1	
		DAC53608, $2.7\text{ V} \leq V_{DD} \leq 5.5\text{ V}$	-1		1	
		DAC53608, $1.8\text{ V} \leq V_{DD} \leq 2.7\text{ V}$	-1		1	
	Zero code error	$2.7\text{ V} \leq V_{DD} \leq 5.5\text{ V}$ , code 0d into DAC		6	12	mV
		$1.8\text{ V} \leq V_{DD} \leq 2.7\text{ V}$ , code 0d into DAC		6	12	
	Zero code error temperature coefficient			$\pm 5$		$\mu\text{V}/^\circ\text{C}$
	Offset error <sup>(1)</sup>	$2.7\text{ V} \leq V_{DD} \leq 5.5\text{ V}$	-0.5	0.25	0.5	%FSR
		$1.8\text{ V} \leq V_{DD} \leq 2.7\text{ V}$	-0.5	0.25	0.5	
	Offset error temperature coefficient <sup>(1)</sup>			$\pm 0.0003$		%FSR/ $^\circ\text{C}$
	Gain error <sup>(1)</sup>	$2.7\text{ V} \leq V_{DD} \leq 5.5\text{ V}$	-0.5	0.25	0.5	%FSR
		$1.8\text{ V} \leq V_{DD} \leq 2.7\text{ V}$	-0.5	0.25	0.5	
	Gain error temperature coefficient <sup>(1)</sup>			$\pm 0.0004$		%FSR/ $^\circ\text{C}$
	Full scale error	$2.7\text{ V} \leq V_{DD} \leq 5.5\text{ V}$ , code 1023d into DAC, no headroom	-0.5	0.25	0.5	%FSR
		$1.8\text{ V} \leq V_{DD} \leq 2.7\text{ V}$ , code 1023d into DAC, no headroom	-1	0.5	1	
	Full scale error temperature coefficient			$\pm 0.0004$		%FSR/ $^\circ\text{C}$
<b>OUTPUT CHARACTERISTICS</b>						
$V_{OUTX}$	Output voltage		0		5.5	V
$C_L$	Capacitive load <sup>(2)</sup>	$R_L = \text{Infinite}$			1	nF
		$R_L = 5\text{ k}\Omega$			2	
	Load regulation	DAC at midscale, $-10\text{ mA} \leq I_{OUT} \leq 10\text{ mA}$ , $V_{DD} = 5.5\text{ V}$		0.1		mV/mA
	Short circuit current	$V_{DD} = 1.8\text{ V}$ , (per channel) full-scale output shorted to $A_{GND}$ or zero-scale output shorted to $V_{DD}$		10		mA
		$V_{DD} = 2.7\text{ V}$ , (per channel) full-scale output shorted to $A_{GND}$ or zero-scale output shorted to $V_{DD}$		25		
		$V_{DD} = 5.5\text{ V}$ , (per channel) full-scale output shorted to $A_{GND}$ or zero-scale output shorted to $V_{DD}$		50		
	Output voltage headroom	to $V_{DD}$ (DAC output unloaded)		0.05		V
	Output voltage headroom <sup>(2)</sup>	to $V_{DD}$ (load current = $10\text{ mA}$ @ $V_{DD} = 5.5\text{ V}$ , load current = $3\text{ mA}$ @ $V_{DD} = 2.7\text{ V}$ , load current = $1\text{ mA}$ @ $V_{DD} = 1.8\text{ V}$ ), DAC code = full Scale	10			%FSR

(1) End point fit between codes Code 4 to Code 1016 for 10 bit, Code 1 to Code 251 for 8 bit

(2) Not production tested

**Electrical Characteristics (continued)**

all minimum/maximum specifications at  $T_A = -40^{\circ}\text{C}$  to  $+125^{\circ}\text{C}$  and all typical specification at  $T_A = 25^{\circ}\text{C}$ ,  $1.8\text{ V} \leq V_{DD} \leq 5.5\text{ V}$ ,  $V_{REFIN} = 2.5\text{ V}$  for  $V_{DD} \geq 2.7\text{ V}$ ,  $V_{REFIN} = 1.8\text{ V}$  for  $V_{DD} \leq 2.7\text{ V}$ ,  $R_L = 5\text{ k}\Omega$  to  $A_{GND}$ ,  $C_L = 200\text{ pF}$  to  $A_{GND}$ , and digital inputs at  $V_{DD}$  or  $A_{GND}$  (unless otherwise noted)

PARAMETER		TEST CONDITIONS	MIN	TYP	MAX	UNIT
$Z_O$	DC output impedance	DAC at midscale		0.25		$\Omega$
		DAC at code 4d		0.25		
		DAC at code 1016		0.26		
DC-PSRR	Power supply rejection ratio (DC)	DAC at midscale; $V_{DD} = 5\text{ V} \pm 10\%$		0.25		mV/V
<b>DYNAMIC PERFORMANCE</b>						
$t_{\text{sett}}$	Output voltage settling time	1/4 to 3/4 scale and 3/4 to 1/4 scale settling to 10%FSR, $R_L = 5\text{ k}\Omega$ , $C_L = 200\text{ pF}$ , $V_{DD} = 5.5\text{ V}$		10		$\mu\text{s}$
SR	Slew rate	$R_L = 5\text{ k}\Omega$ , $C_L = 200\text{ pF}$ , $V_{DD} = 5.5\text{ V}$		0.6		V/ $\mu\text{s}$
	Power on glitch magnitude	$R_L = 5\text{ k}\Omega$ , $C_L = 200\text{ pF}$		110		mV
$V_n$	Output noise	0.1 Hz to 10 Hz, DAC at midscale, $V_{DD} = 5.5\text{ V}$		40		$\mu\text{V}_{pp}$
$V_n$	Output noise	0.1 Hz to 100 kHz bandwidth, DAC at midscale, $V_{DD} = 5.5\text{ V}$		0.05		mV <sub>rms</sub>
$V_n$	Output noise density	measured at 1 kHz, DAC at midscale, $V_{DD} = 5.5\text{ V}$		0.2		$\mu\text{V}/\sqrt{\text{Hz}}$
		measured at 10 kHz, DAC at midscale, $V_{DD} = 5.5\text{ V}$		0.2		
AC-PSRR	Power supply rejection ratio (AC)	200 mV 50/60 Hz sine wave superimposed on power supply voltage, DAC at midscale		-71		dB
	Channel-to-channel AC crosstalk	Full-scale swing on adjacent channel		1.5		nV-s
	Channel-to-channel DC crosstalk	Full-scale swing on all channel, measured channel at zero or full scale		0.05		LSB
	Code change glitch impulse	$\pm 1$ LSB change around mid code (including feedthrough)		10		nV-s
	Code change glitch impulse magnitude	$\pm 1$ LSB change around mid code (including feedthrough)		25		mV
<b>VOLTAGE REFERENCE INPUT</b>						
	Reference input impedance	All channel powered on		12.5		k $\Omega$
	Reference input capacitance			50		pF
<b>DIGITAL INPUTS</b>						
	Digital feedthrough	At SCLK = 1 MHz, DAC output static at mid scale		20		nV-s
	Pin capacitance	Per pin		10		pF
<b>POWER REQUIREMENTS</b>						
$I_{V_{DD}}$	Current flowing into $V_{DD}$	Normal mode, all DACs at full scale. SPI static.		3	5	mA
$I_{V_{DD}}$	Current flowing into $V_{DD}$	All DACs power-down		50		$\mu\text{A}$

## 7.6 Timing Requirements: I<sup>2</sup>C™ Standard Mode

all input signals are timed from VIL to 70% of V<sub>DD</sub>, 1.8 V ≤ V<sub>DD</sub> ≤ 5.5 V, 1.8 V ≤ V<sub>REFIN</sub> ≤ V<sub>DD</sub>, -40°C ≤ T<sub>A</sub> ≤ +125°C, V<sub>pull up</sub> = V<sub>DD</sub> for 1.8 V ≤ V<sub>DD</sub> ≤ 2.7 V, V<sub>pull up</sub> = 2.7 V or V<sub>DD</sub> for 2.7 V ≤ V<sub>DD</sub> ≤ 5.5 V

		MIN	NOM	MAX	UNIT
f <sub>SCLK</sub>	SCLK frequency			0.1	MHz
t <sub>BUF</sub>	Bus free time between stop and start conditions	4.7			μs
t <sub>HDSTA</sub>	Hold time after repeated start	4			μs
t <sub>SUSTA</sub>	Repeated start setup time	4.7			μs
t <sub>SUSTO</sub>	Stop condition setup time	4			μs
t <sub>HDDAT</sub>	Data hold time	0			ns
t <sub>SUDAT</sub>	Data setup time	250			ns
t <sub>LOW</sub>	SCL clock low period	4700			ns
t <sub>HIGH</sub>	SCL clock high period	4700			ns
t <sub>F</sub>	Clock and data fall time			300	ns
t <sub>R</sub>	Clock and data rise time			1000	ns

## 7.7 Timing Requirements: I<sup>2</sup>C™ Fast Mode

all input signals are timed from VIL to 70% of V<sub>DD</sub>, 1.8 V ≤ V<sub>DD</sub> ≤ 5.5 V, 1.8 V ≤ V<sub>REFIN</sub> ≤ V<sub>DD</sub>, -40°C ≤ T<sub>A</sub> ≤ +125°C, V<sub>pull up</sub> = V<sub>DD</sub> for 1.8 V ≤ V<sub>DD</sub> ≤ 2.7 V, V<sub>pull up</sub> = 2.7 V or V<sub>DD</sub> for 2.7 V ≤ V<sub>DD</sub> ≤ 5.5 V

		MIN	NOM	MAX	UNIT
f <sub>SCLK</sub>	SCLK frequency			0.4	MHz
t <sub>BUF</sub>	Bus free time between stop and start conditions	1.3			μs
t <sub>HDSTA</sub>	Hold time after repeated start	0.6			μs
t <sub>SUSTA</sub>	Repeated start setup time	0.6			μs
t <sub>SUSTO</sub>	Stop condition setup time	0.6			μs
t <sub>HDDAT</sub>	Data hold time	0			ns
t <sub>SUDAT</sub>	Data setup time	100			ns
t <sub>LOW</sub>	SCL clock low period	1300			ns
t <sub>HIGH</sub>	SCL clock high period	600			ns
t <sub>F</sub>	Clock and data fall time			300	ns
t <sub>R</sub>	Clock and data rise time			300	ns

## 7.8 Timing Requirements: I<sup>2</sup>C™ Fast+ Mode

all input signals are timed from VIL to 70% of V<sub>DD</sub>, 1.8 V ≤ V<sub>DD</sub> ≤ 5.5 V, 1.8 V ≤ V<sub>REFIN</sub> ≤ V<sub>DD</sub>, -40°C ≤ T<sub>A</sub> ≤ +125°C, V<sub>pull up</sub> = V<sub>DD</sub> for 1.8 V ≤ V<sub>DD</sub> ≤ 2.7 V, V<sub>pull up</sub> = 2.7 V or V<sub>DD</sub> for 2.7 V ≤ V<sub>DD</sub> ≤ 5.5 V

		MIN	NOM	MAX	UNIT
f <sub>SCLK</sub>	SCL frequency			1	MHz
t <sub>BUF</sub>	Bus free time between stop and start conditions	0.5			μs
t <sub>HDSTA</sub>	Hold time after repeated start	0.26			μs
t <sub>SUSTA</sub>	Repeated start setup time	0.26			μs
t <sub>SUSTO</sub>	Stop condition setup time	0.26			μs
t <sub>HDDAT</sub>	Data hold time	0			ns
t <sub>SUDAT</sub>	Data setup time	50			ns
t <sub>LOW</sub>	SCL clock low period	0.5			μs
t <sub>HIGH</sub>	SCL clock high period	0.26			μs
t <sub>F</sub>	Clock and data fall time			120	ns
t <sub>R</sub>	Clock and data rise time			120	ns

## 7.9 Timing Requirements: Logic

all input signals are timed from VIL to 70% of V<sub>DD</sub>, 1.8 V ≤ V<sub>DD</sub> ≤ 5.5 V, 1.8 V ≤ V<sub>REFIN</sub> ≤ V<sub>DD</sub>, -40°C ≤ T<sub>A</sub> ≤ +125°C, V<sub>pull up</sub> = V<sub>DD</sub> for 1.8 V ≤ V<sub>DD</sub> ≤ 2.7 V, V<sub>pull up</sub> = 2.7 V or V<sub>DD</sub> for 2.7 V ≤ V<sub>DD</sub> ≤ 5.5 V

		MIN	NOM	MAX	UNIT
t <sub>LDACAH</sub>	SCL fall edge to $\overline{\text{LDAC}}$ rise edge, 1.7 V ≤ V <sub>DD</sub> ≤ 2.7 V	20			ns
t <sub>LDACAH</sub>	SCL fall edge to $\overline{\text{LDAC}}$ rise edge, 2.7 V < V <sub>DD</sub> ≤ 5.5 V	20			ns
t <sub>LDACAL</sub>	$\overline{\text{LDAC}}$ fall edge to SCL fall edge, 1.7 V ≤ V <sub>DD</sub> ≤ 5.5 V	10			clock cycle
t <sub>LDACSH</sub>	SCL fall edge to $\overline{\text{LDAC}}$ rise edge, 1.7 V ≤ V <sub>DD</sub> ≤ 2.7 V	80			ns
t <sub>LDACSH</sub>	SCL fall edge to $\overline{\text{LDAC}}$ rise edge, 2.7 V < V <sub>DD</sub> ≤ 5.5 V	50			ns
t <sub>LDACSL</sub>	SCL fall edge to $\overline{\text{LDAC}}$ fall edge, 1.7 V ≤ V <sub>DD</sub> ≤ 2.7 V	20			ns
t <sub>LDACSL</sub>	SCL fall edge to $\overline{\text{LDAC}}$ fall edge, 2.7 V < V <sub>DD</sub> ≤ 5.5 V	20			ns
t <sub>LDACW</sub>	$\overline{\text{LDAC}}$ low time, 1.7 V ≤ V <sub>DD</sub> < 2.7 V	30			ns
t <sub>LDACW</sub>	$\overline{\text{LDAC}}$ low time, 2.7 V ≤ V <sub>DD</sub> ≤ 5.5 V	60			ns
t <sub>CLR<math>\overline{\text{W}}</math></sub>	$\overline{\text{CLR}}$ low time, 1.7 V ≤ V <sub>DD</sub> < 2.7 V	30			ns
t <sub>CLR<math>\overline{\text{W}}</math></sub>	$\overline{\text{CLR}}$ low time, 2.7 V ≤ V <sub>DD</sub> ≤ 5.5 V	60			ns

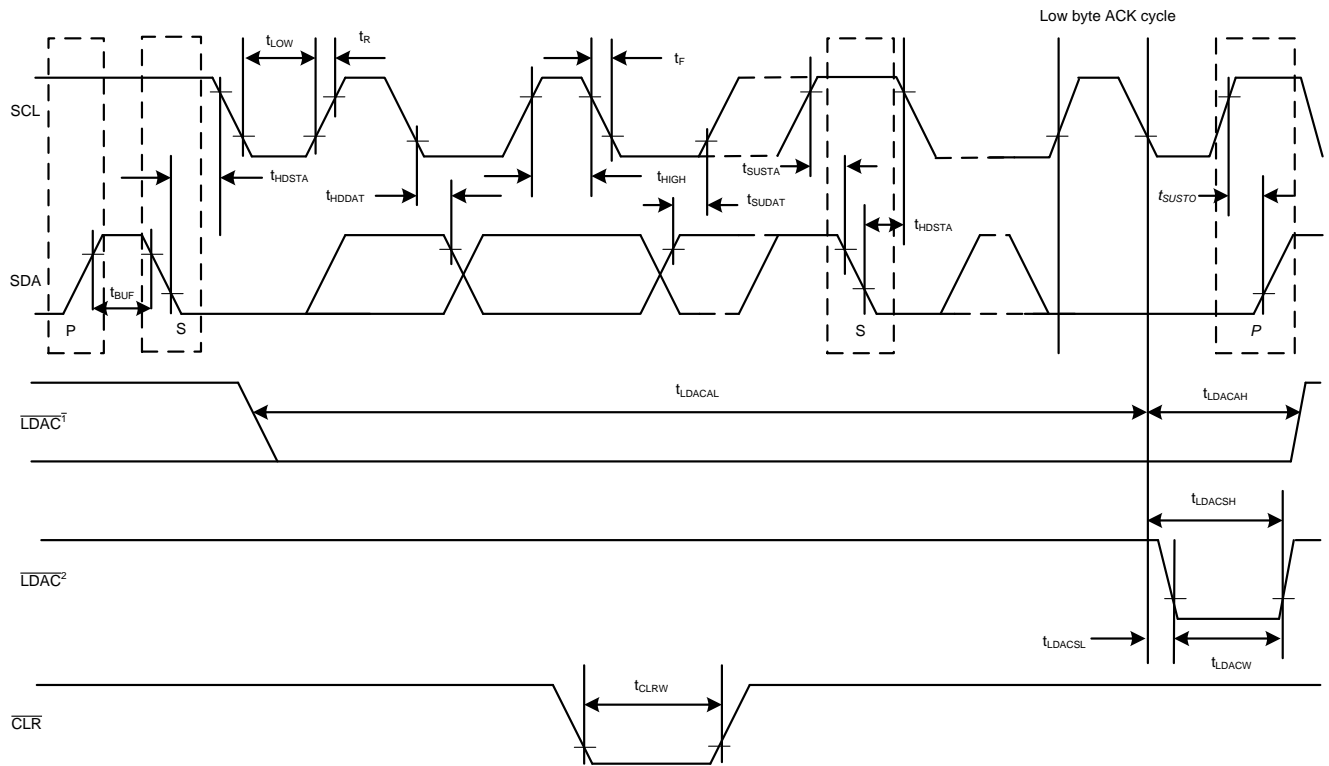

**Figure 1. Serial Interface Timing Diagram**

### 7.10 Typical Characteristics: 1.8 V

at  $T_A = 25^\circ\text{C}$ ,  $V_{DD} = 1.8\text{ V}$ , reference = 1.8 V, and DAC outputs unloaded (unless otherwise noted)

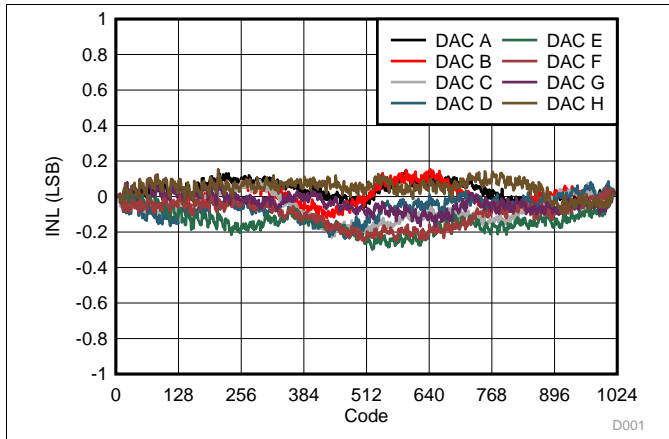

Figure 2. Integral Linearity Error vs Digital Input Code

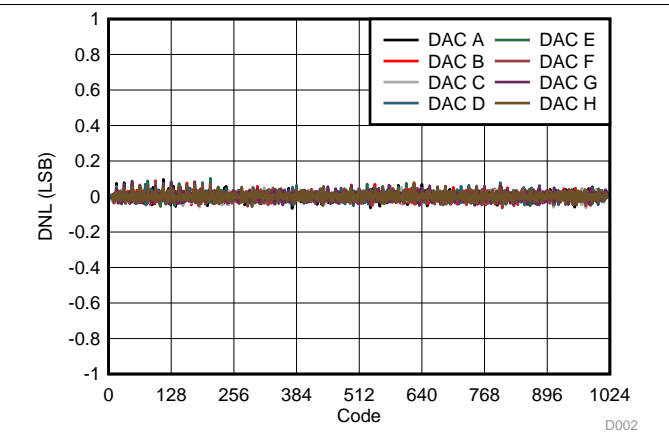

Figure 3. Differential Linearity Error vs Digital Input Code

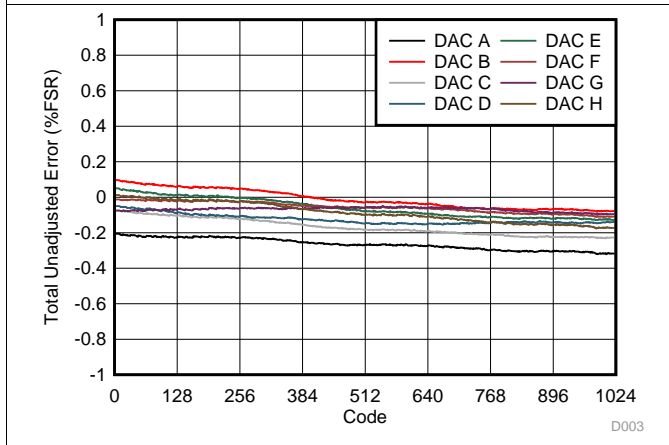

Figure 4. Total Unadjusted Error vs Digital Input Code

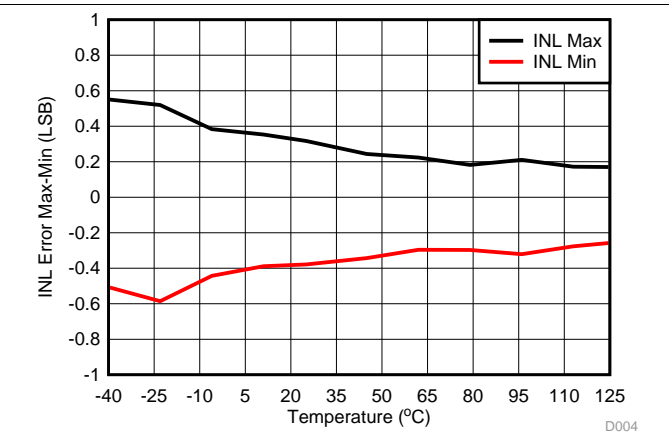

Figure 5. Integral Linearity Error vs Temperature

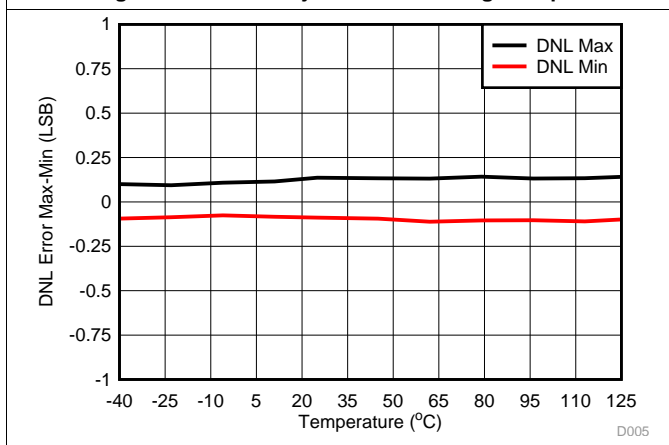

Figure 6. Differential Linearity Error vs Temperature

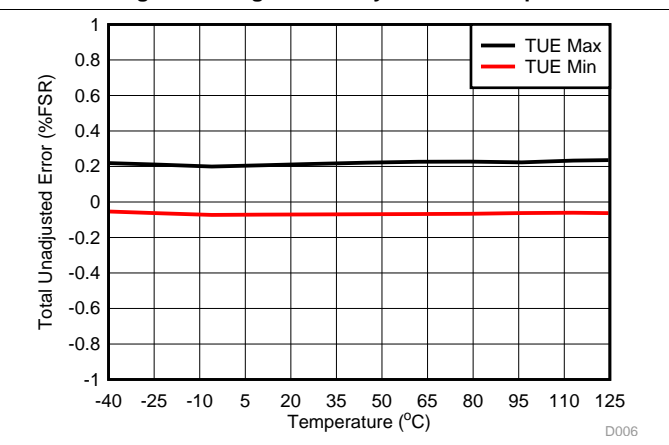
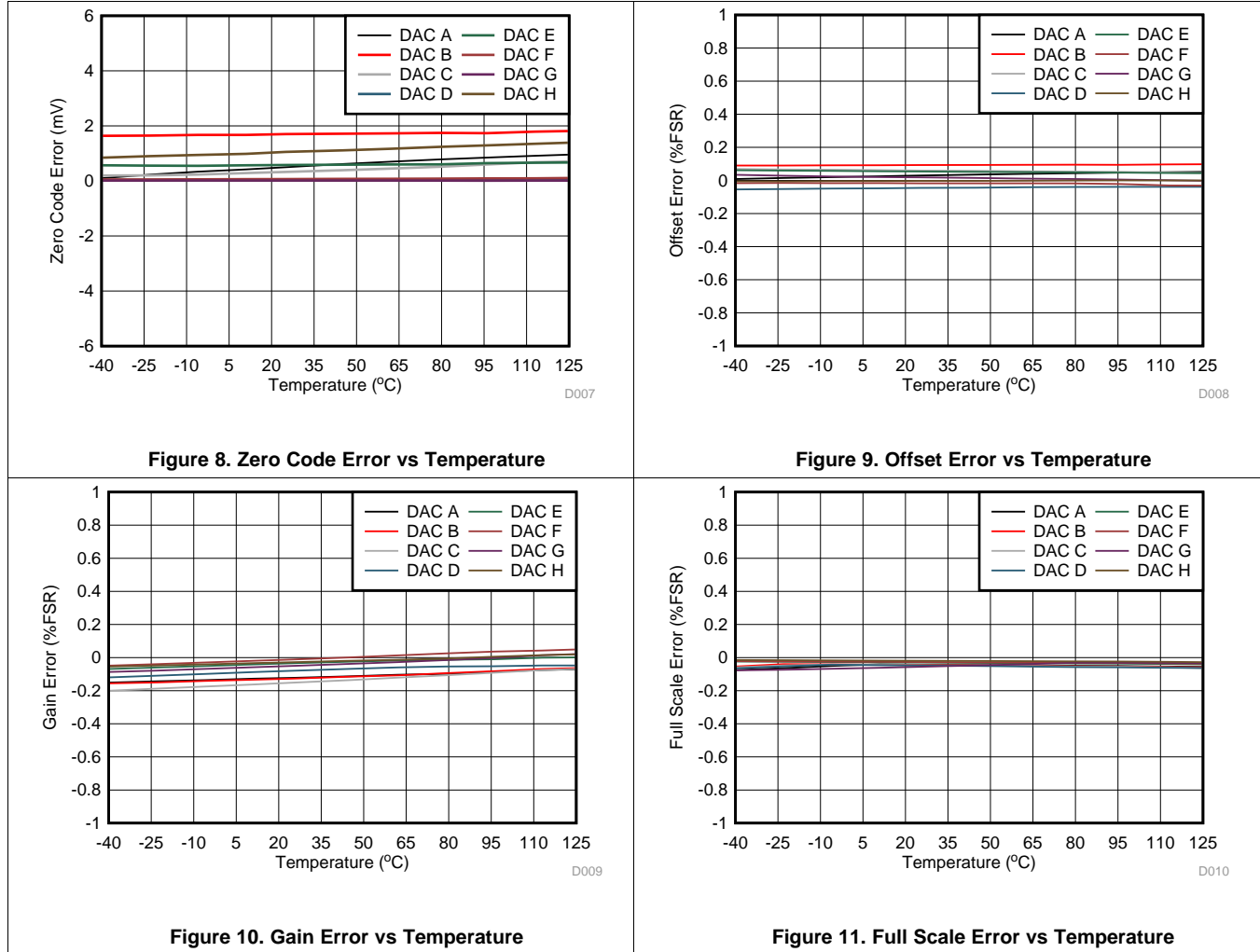

Figure 7. Total Unadjusted Error vs Temperature

Typical Characteristics: 1.8 V (continued)

at  $T_A = 25^\circ\text{C}$ ,  $V_{DD} = 1.8\text{ V}$ , reference = 1.8 V, and DAC outputs unloaded (unless otherwise noted)



### 7.11 Typical Characteristics: 5.5 V

at  $T_A = 25^\circ\text{C}$ ,  $V_{DD} = 5.5\text{ V}$ , reference = 5.5 V, and DAC outputs unloaded (unless otherwise noted)

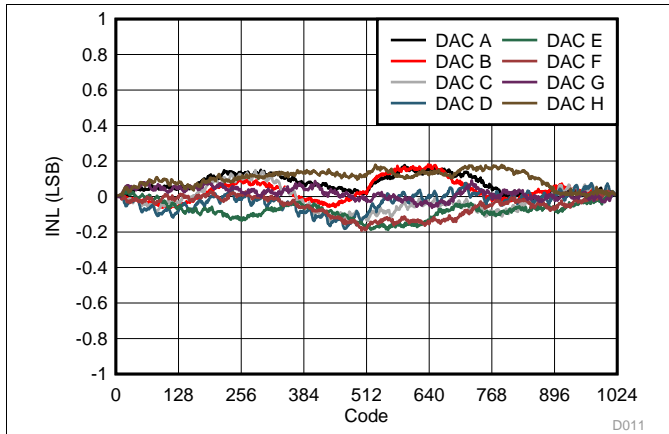

Figure 12. Integral Linearity Error vs Digital Input Code

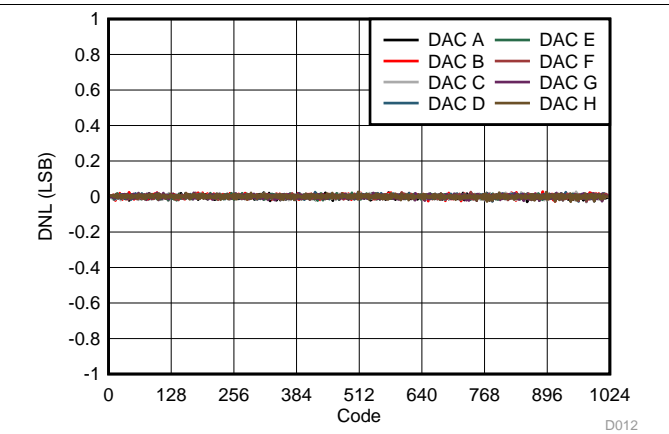

Figure 13. Differential Linearity Error vs Digital Input Code

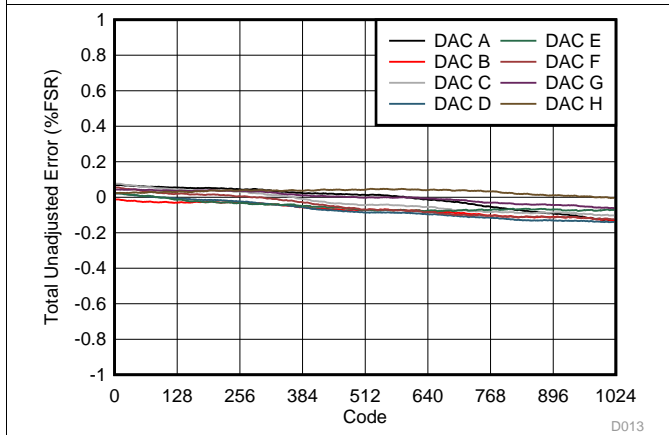

Figure 14. Total Unadjusted Error vs Digital Input Code

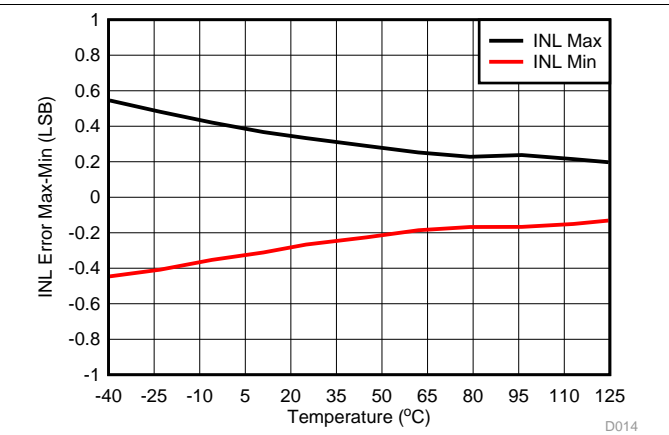

Figure 15. Integral Linearity Error vs Temperature

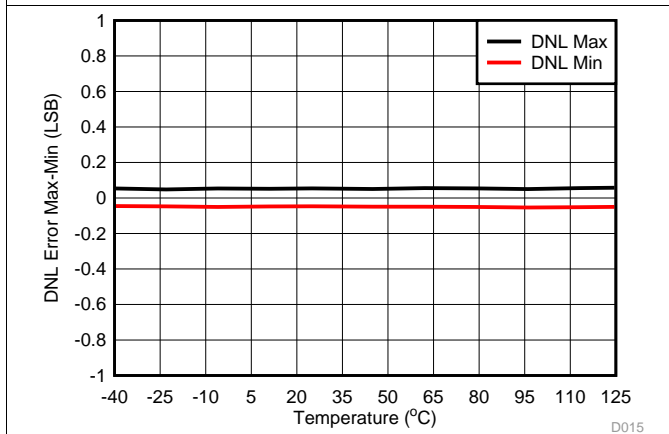

Figure 16. Differential Linearity Error vs Temperature

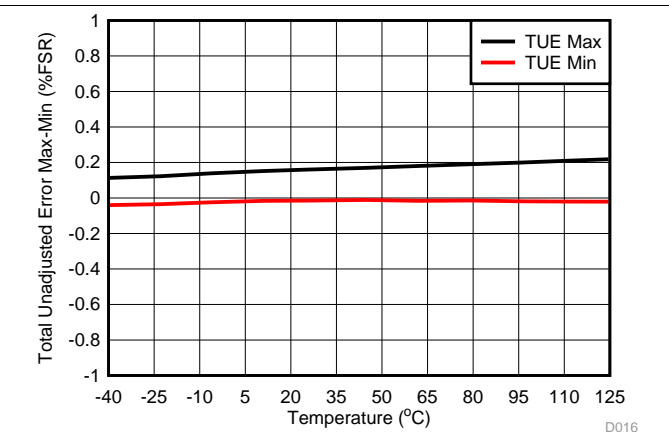
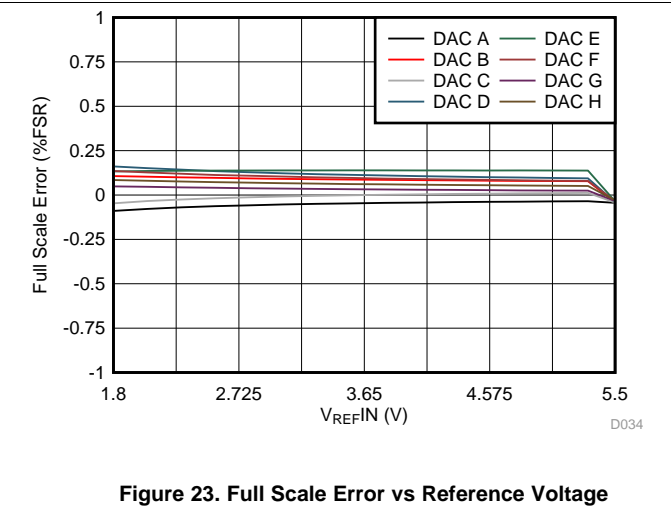
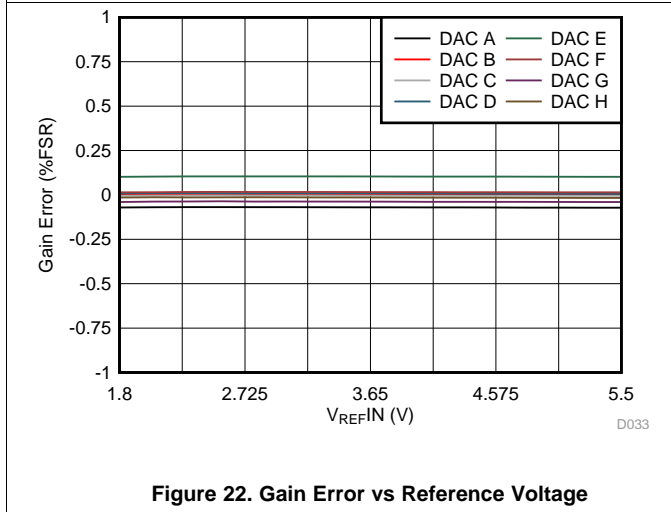
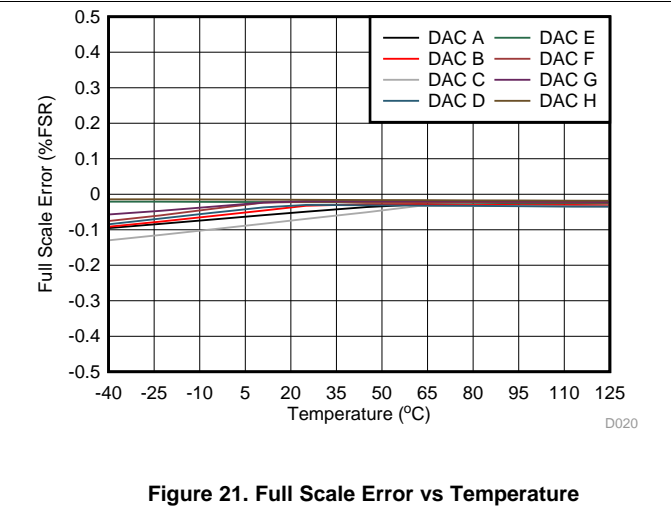
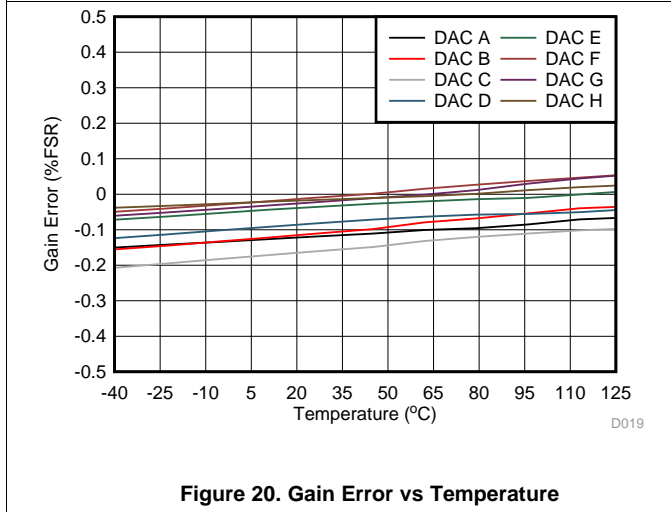
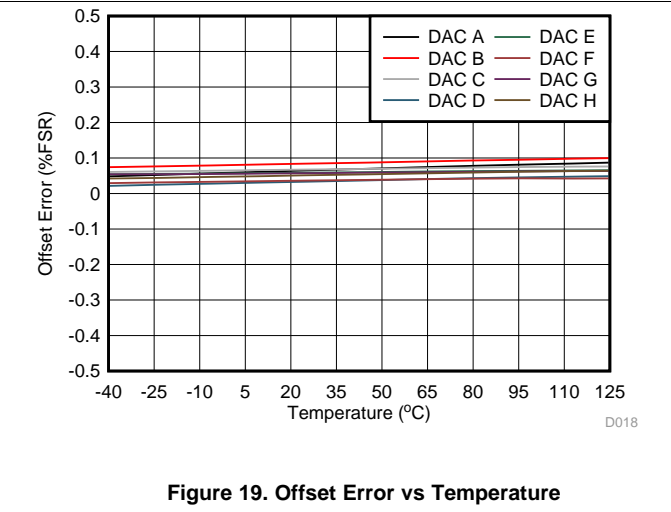
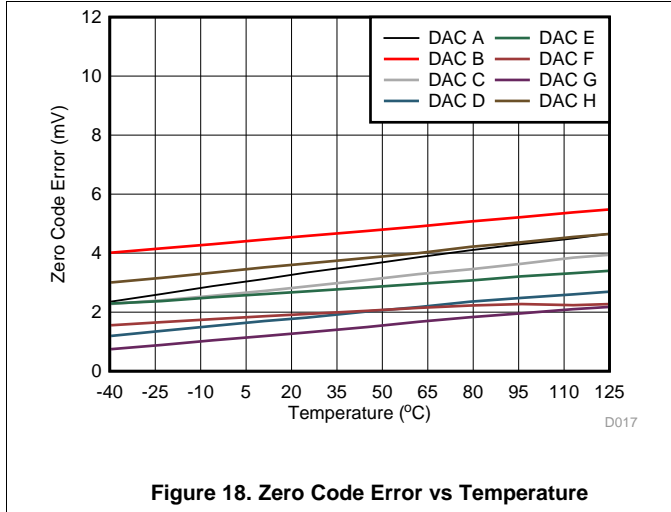

Figure 17. Total Unadjusted Error vs Temperature

Typical Characteristics: 5.5 V (continued)

at  $T_A = 25^\circ\text{C}$ ,  $V_{DD} = 5.5\text{ V}$ , reference = 5.5 V, and DAC outputs unloaded (unless otherwise noted)



Typical Characteristics: 5.5 V (continued)

at  $T_A = 25^\circ\text{C}$ ,  $V_{DD} = 5.5\text{ V}$ , reference = 5.5 V, and DAC outputs unloaded (unless otherwise noted)

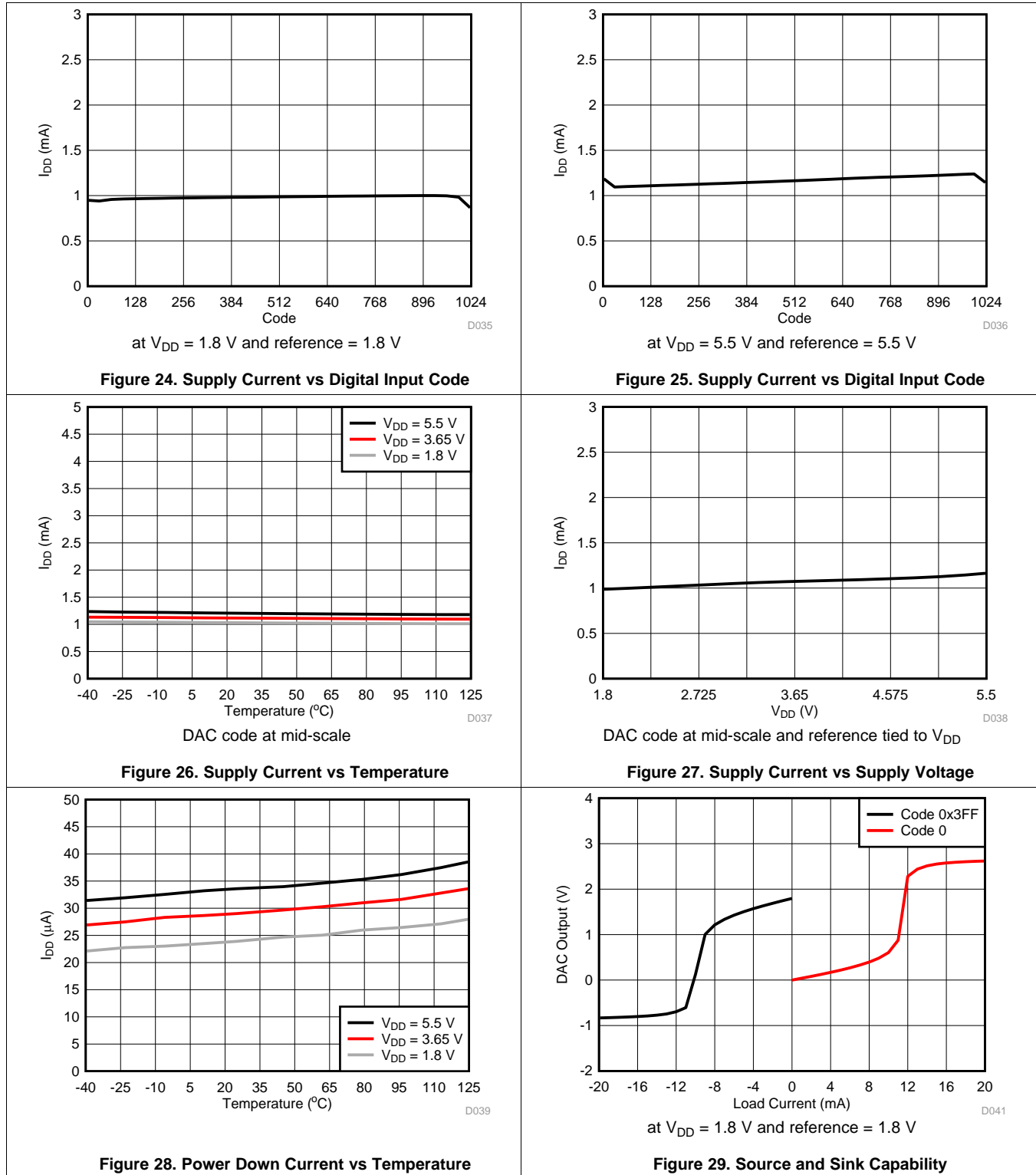

Typical Characteristics: 5.5 V (continued)

at  $T_A = 25^\circ\text{C}$ ,  $V_{DD} = 5.5\text{ V}$ , reference = 5.5 V, and DAC outputs unloaded (unless otherwise noted)

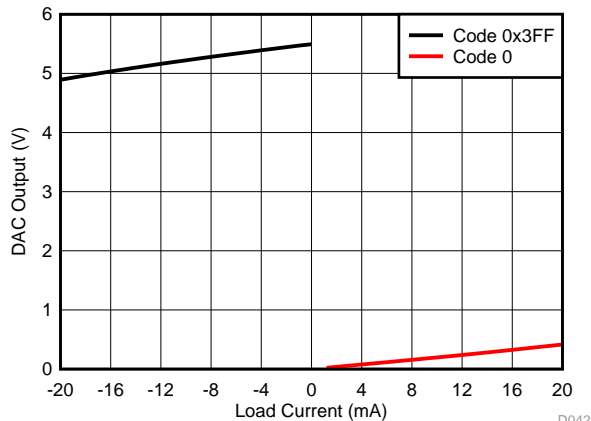

at  $V_{DD} = 5.5\text{ V}$  and reference = 5.5 V

Figure 30. Source and Sink Capability

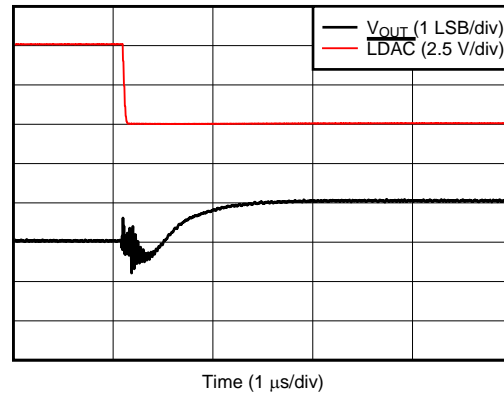

DAC code transition from mid-scale – 1 to mid-scale, DAC output loaded with 5 kΩ/200 pF

Figure 31. Glitch Impulse, Rising Edge, 1 LSB Step

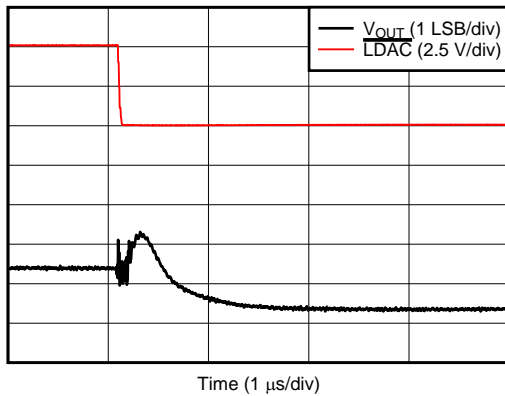

DAC code transition from mid-scale to mid-scale – 1 LSB, DAC output loaded with 5 kΩ/200 pF

Figure 32. Glitch Impulse, Falling Edge, 1 LSB Step

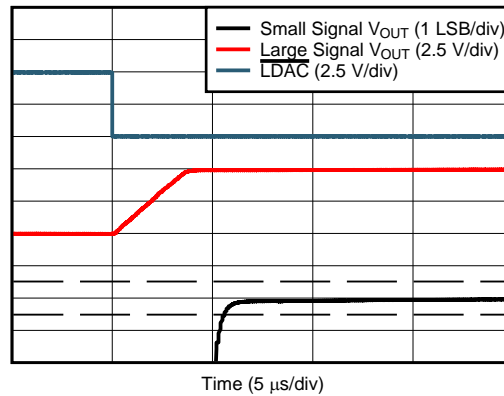

DAC code transition from 102d to 922d, typical channel shown, DAC output loaded with 5 kΩ/200 pF

Figure 33. Full-Scale Settling Time, Rising Edge

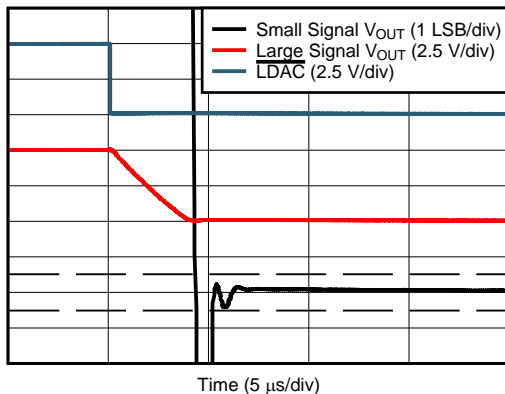

DAC code transition from 922d to 102d, typical channel shown, DAC output loaded with 5 kΩ/200 pF

Figure 34. Full-Scale Settling Time, Falling Edge

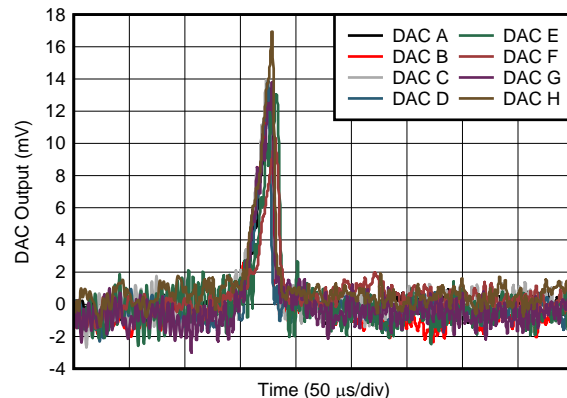

DAC output loaded with 5 kΩ/200 pF

Figure 35. Power-on Glitch

**Typical Characteristics: 5.5 V (continued)**

at  $T_A = 25^\circ\text{C}$ ,  $V_{DD} = 5.5\text{ V}$ , reference = 5.5 V, and DAC outputs unloaded (unless otherwise noted)

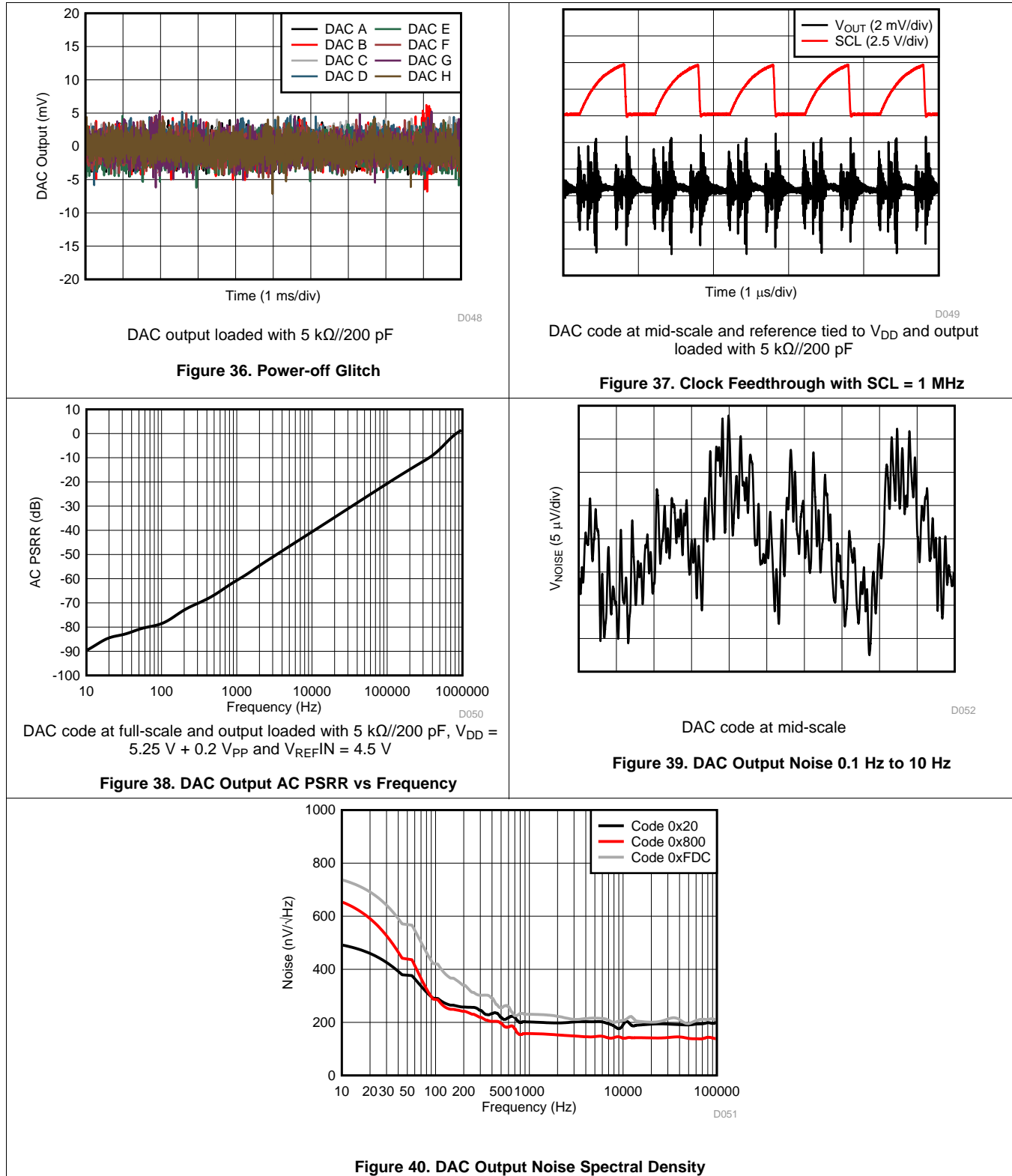

## 7.12 Typical Characteristics

at  $T_A = 25^\circ\text{C}$ , and DAC outputs unloaded (unless otherwise noted)

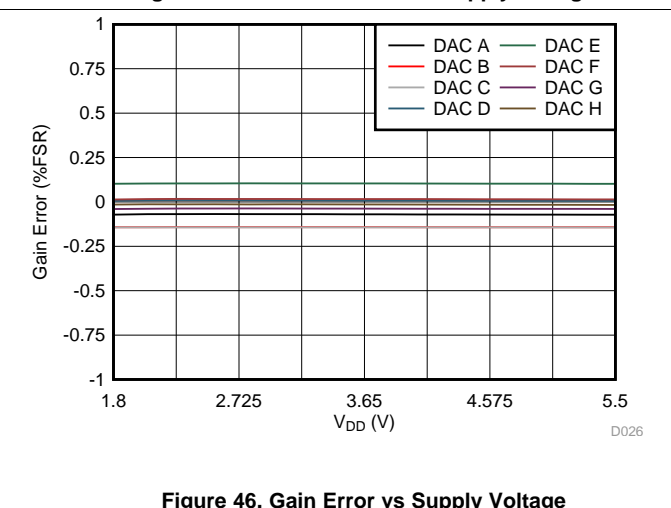
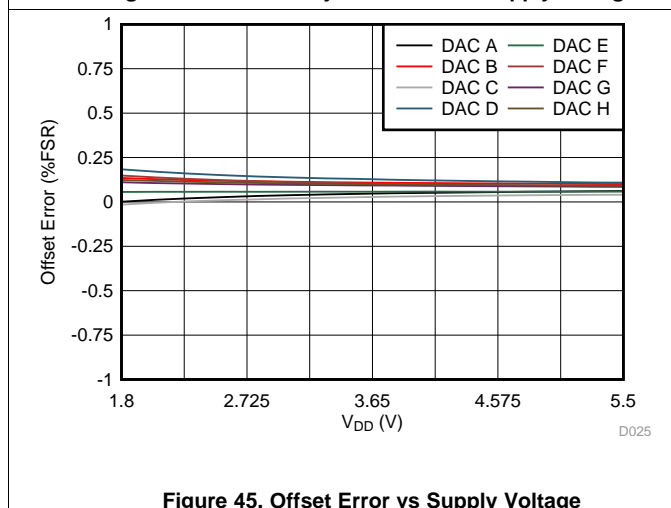
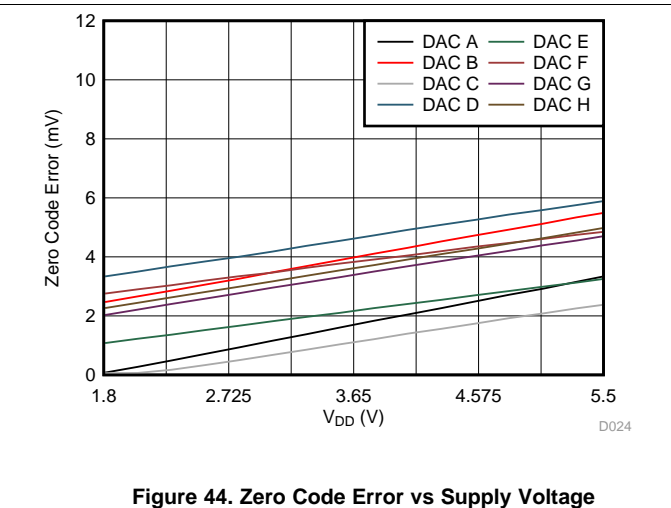
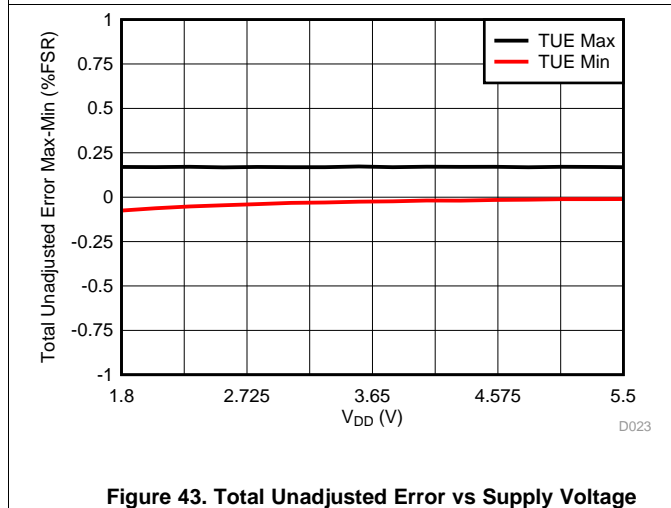
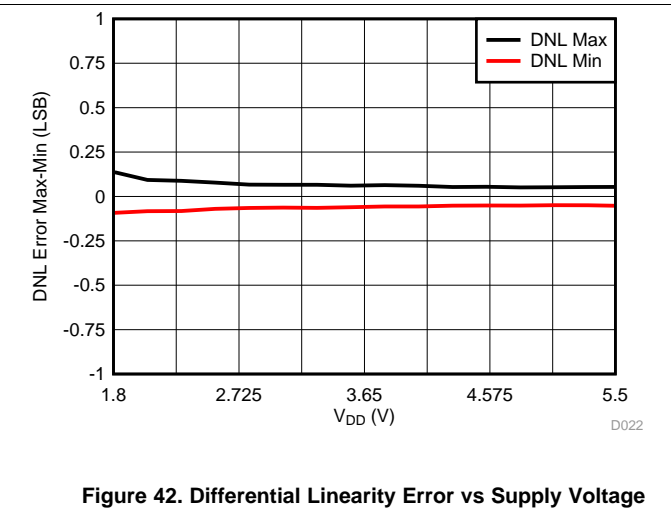
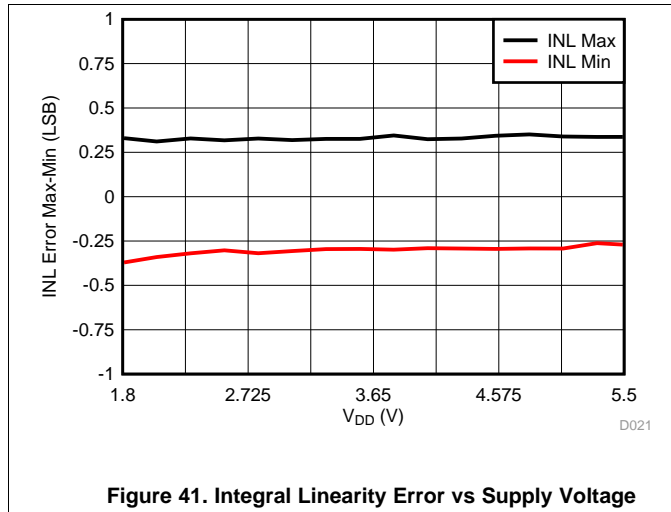

### 7.13 Typical Characteristics

at  $T_A = 25^\circ\text{C}$ ,  $V_{DD} = 5.5\text{ V}$ , and DAC outputs unloaded (unless otherwise noted)

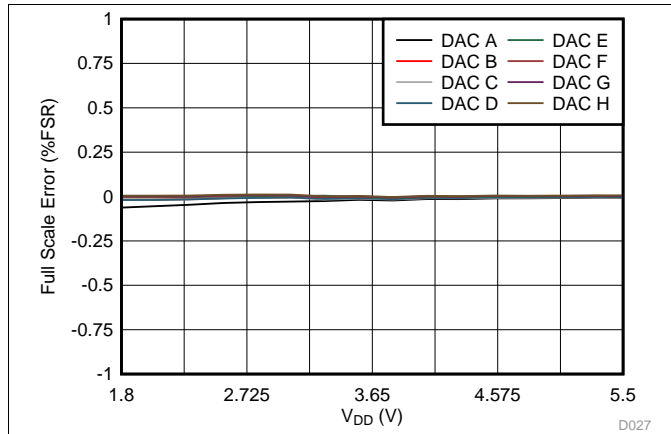

Figure 47. Full Scale Error vs Supply Voltage

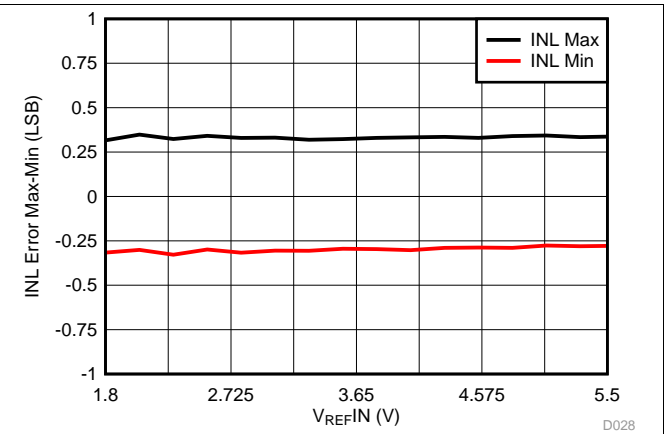

Figure 48. Integral Linearity Error vs Reference Voltage

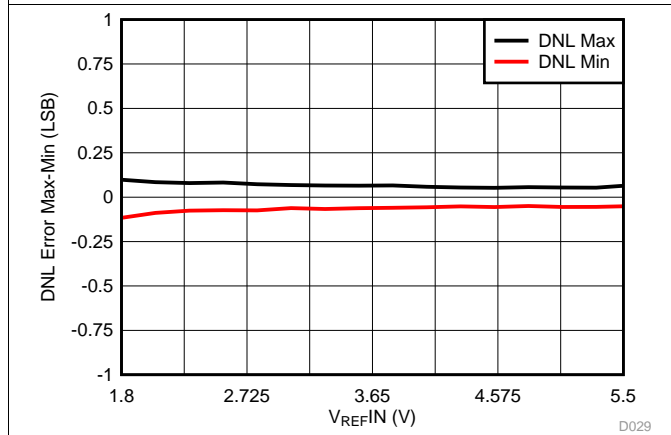

Figure 49. Differential Linearity Error vs Reference Voltage

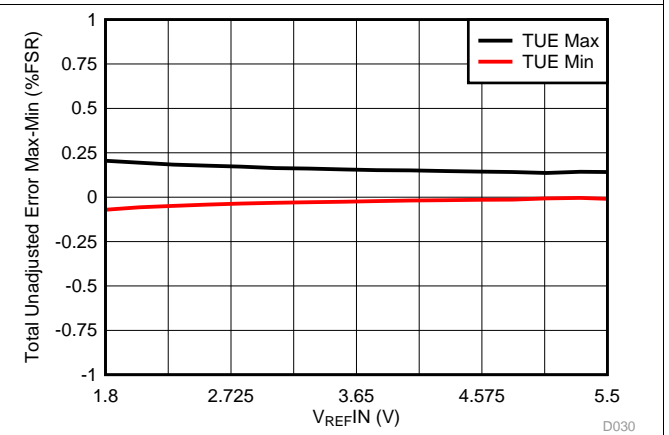

Figure 50. Total Unadjusted Error vs Reference Voltage

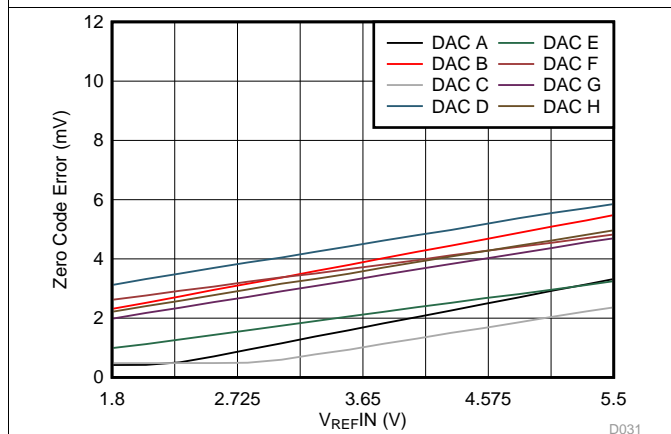

Figure 51. Zero Code Error vs Reference Voltage

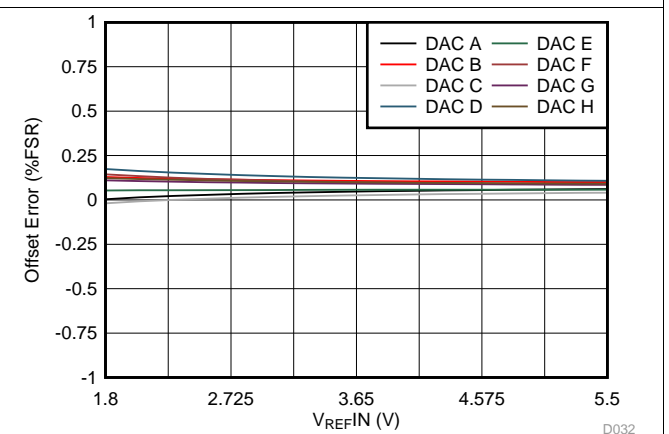

Figure 52. Offset Error vs Reference Voltage

## 8 Detailed Description

### 8.1 Overview

The DAC53608 and DAC43608 are a pin-compatible family of eight-channel, buffered voltage-output digital-to-analog converters (DACs) in 10- and 8-bit resolution. With an external reference ranging from 1.8 V to 5.5 V, full scale output voltage of 1.8 V to 5.5 V can be achieved. These devices are guaranteed monotonic across the power supply range.

Communication to the devices is done through I<sup>2</sup>C™ compatible interface. The I<sup>2</sup>C™ standard (100 kbps), fast (400 kbps), and fast+ mode (1Mbps) are supported for these devices. These devices include a load DAC (LDAC) pin for simultaneous DAC update.

The DACx3608 devices are characterized for operation over the temperature range of -40°C to +125°C and are available in tiny QFN packages.

### 8.2 Functional Block Diagram

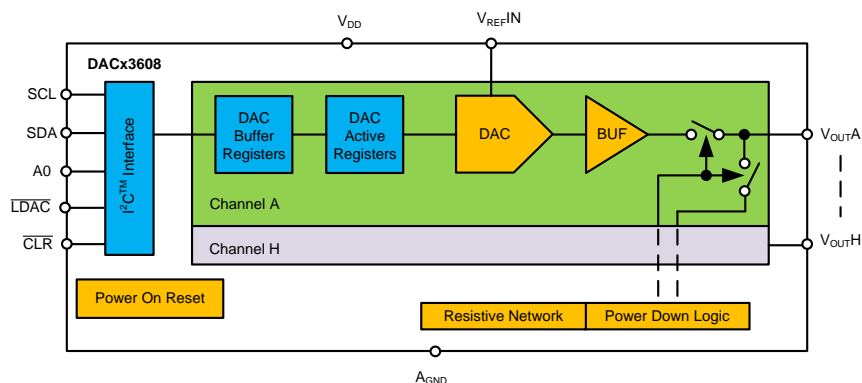
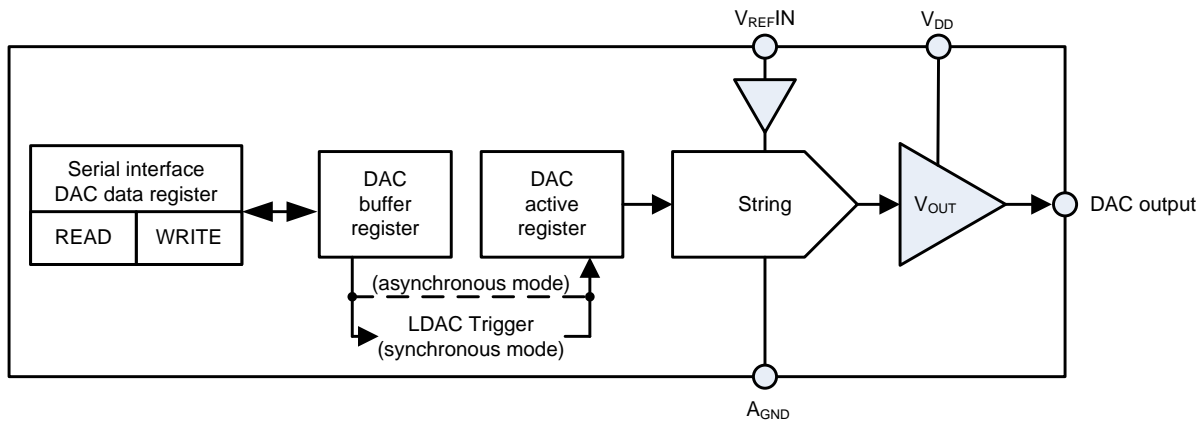

Figure 53. DACx3608 DAC Block Diagram

## 8.3 Feature Description

### 8.3.1 Digital-to-Analog Converter (DAC) Architecture

Each output channel in the DACx3608 family of devices consists of string architecture with an output buffer amplifier. Figure 54 shows a block diagram of the DAC architecture.



**Figure 54. DACx3608 DAC Architecture**

#### 8.3.1.1 DAC Transfer Function

The device writes the input data to the individual DAC Data registers in straight binary format. After a power-on or a reset event, the device sets all DAC registers to zero-code. Equation 1 shows DAC transfer function.

$$V_{OUTX} = \frac{DACn\_DATA}{2^N} \times V_{REFIN}$$

where:

- N = resolution in bits
  - Either 10 (DAC53608) or 8 (DAC43608)
- DACn\_DATA is the decimal equivalent of the binary code that is loaded to the DAC register
- DACn\_DATA ranges from 0 to  $2^N - 1$
- $V_{REFIN}$  is the DAC reference voltage

(1)

#### 8.3.1.2 DAC Register Update and $\overline{LDAC}$ Functionality

The device stores the data written to the DAC Data registers in the DAC buffer registers. Transfer of data from the DAC buffer registers to the DAC active registers can be set to happen immediately (asynchronous mode) or initiated by an  $\overline{LDAC}$  trigger (synchronous mode). Once the DAC active registers are updated, the DAC outputs change to their new values.

The update mode for each DAC channel is determined by the status of  $\overline{LDAC}$  pin.

In asynchronous mode ( $\overline{LDAC} = 0$  before the DAC write command), a write to the DAC data register results in an immediate update of the DAC active register and DAC output at the end of I<sup>2</sup>C™ frame.

In synchronous mode ( $\overline{LDAC} = 1$  before the DAC write command), writing to the DAC data register does not automatically update the DAC output. Instead the update occurs only after an  $\overline{LDAC}$  is pulled to 0. The synchronous update mode enables simultaneous update of all DAC outputs.

#### 8.3.1.3 $\overline{CLR}$ Functionality

The  $\overline{CLR}$  pin is an asynchronous input pin to the DAC. When this pin is pulled low (logic 0), the DAC buffers and the DAC active registers to zero code.

## Feature Description (continued)

### 8.3.1.4 Output Amplifier

The output buffer amplifier generates rail-to-rail voltages on the output, giving a maximum output range of 0 V to  $V_{DD}$ . Equation 1 shows that the full-scale output range of the DAC output is determined by the voltage on the  $V_{REFIN}$  pin

### 8.3.2 Reference

The DACx3608 requires an external reference to operate. However, the reference pin  $V_{REFIN}$  and the supply pin  $V_{DD}$  can be tied together. The reference input pin voltage ranges from 1.8 V to  $V_{DD}$ . The typical input impedance of this pin when all the channels are powered on is 12.5 k $\Omega$ .

### 8.3.3 Power-on-Reset (POR)

The DACx3608 family of devices includes a power-on reset (POR) function that controls the output voltage at power up. After the  $V_{DD}$  supply has been established, a POR event is issued. The POR causes all registers to initialize to the default values, and communication with the device is valid only after a 5-ms after  $V_{DD}$  reaches DAC operating range. The default value for the DAC data registers is zero-code . The DAC output remains at the power-up voltage until a valid command is written to a channel.

When the device powers up, a POR circuit sets the device to the default mode. The POR circuit requires specific  $V_{DD}$  levels, as indicated in Figure 55, in order to make sure that the internal capacitors discharge and reset the device on power up. In order to make sure that a POR occurs,  $V_{DD}$  must be less than 0.7 V for at least 1 ms. When  $V_{DD}$  drops to less than 1.7 V but remains greater than 0.7 V (shown as the undefined region), the device may or may not reset under all specified temperature and power-supply conditions. In this case, initiate a POR. When  $V_{DD}$  remains greater than 1.7 V, a POR does not occur.

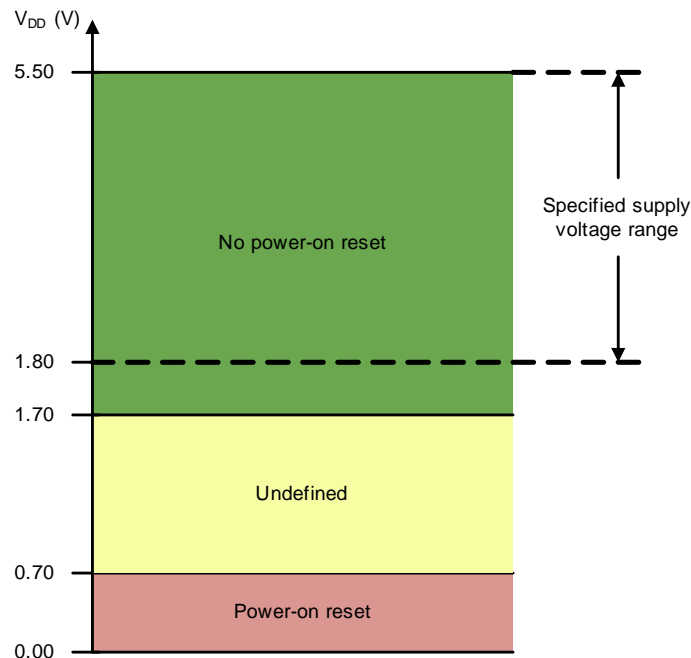

Figure 55. Threshold Levels for  $V_{DD}$  POR Circuit

### 8.3.4 Software Reset

A device software reset event is initiated by writing the reserved code 0x1010 to the SW-RST bit in the TRIGGER register (address 2h).

## 8.4 Device Functional Modes

The DACx3608 has two modes of operation: normal and power-down.

## Device Functional Modes (continued)

### 8.4.1 Power-Down Mode

The DACx3608 DAC output amplifiers can be independently or globally powered down (10K to  $A_{GND}$ ) through the DEVICE\_CONFIG register. In this state, the device consumes 50  $\mu$ A ( $V_{DD} = 1.8$  V). At power-up all output channels buffer amplifiers start in power down to 10K mode until a power up command is issue by writing 0 to the per channel power down registers.

## 8.5 Programming

The DACx3608 devices have a 2-wire serial interface: SCL, SDA, and one address pin, A0, as shown in [Pin Configurations and Functions](#). The I<sup>2</sup>C™ bus consists of a data line (SDA) and a clock line (SCL) with pull-up structures. When the bus is idle, both SDA and SCL lines are pulled high. All the I<sup>2</sup>C™ compatible devices connects to the I<sup>2</sup>C™ bus through open drain I/O pins, SDA and SCL.

The I<sup>2</sup>C™ specification states that the device that controls communication is called a master, and the devices that are controlled by the master are called slaves. The master device generates the SCL signal. The master device also generates special timing conditions (start condition, repeated start condition, and stop condition) on the bus to indicate the start or stop of a data transfer. Device addressing is completed by the master. The master device on an I<sup>2</sup>C™ bus is typically a microcontroller or a digital signal processor (DSP). The DACx3608 family operates as a slave device on the I<sup>2</sup>C™ bus. A slave device acknowledges master's commands and upon master's control, receives or transmits data.

Typically, the DACx3608 family operates as a slave receiver. A master device writes to the DACx3608, a slave receiver. However, if a master device requires the DACx3608 internal register data, the DACx3608 family operates as a slave transmitter. In this case, the master device reads from the DACx3608 According to I<sup>2</sup>C™ terminology, read and write refer to the master device.

The DACx3608 family is a slave and supports the following data transfer modes:

- Standard mode (100 kbps)
- Fast mode (400 kbps)
- Fast+ mode (1.0 Mbps)

The data transfer protocol for standard and fast modes is exactly the same, therefore they are referred to as F/S-mode in this document. The fast+ mode protocol is supported in terms of data transfer speed, but not output current. The low-level output current would be 3 mA similar to the case of standard and fast modes. The DACx3608 family supports 7-bit addressing. The 10-bit addressing mode is not supported. The device supports the general call reset function. Sending the following sequence initiates a software reset within the device; Start/Repeated Start, 0x00, 0x06, Stop. The reset is asserted within the device on the rise edge of the ACK bit, following the second byte.

Other than specific timing signals, the I<sup>2</sup>C™ interface works with serial bytes. At the end of each byte, a ninth clock cycle generates and detects an acknowledge signal. Acknowledge is when the SDA line is pulled low during the high period of the ninth clock cycle. A not-acknowledge is when the SDA line is left high during the high period of the ninth clock cycle as shown in [Figure 56](#).

Programming (continued)

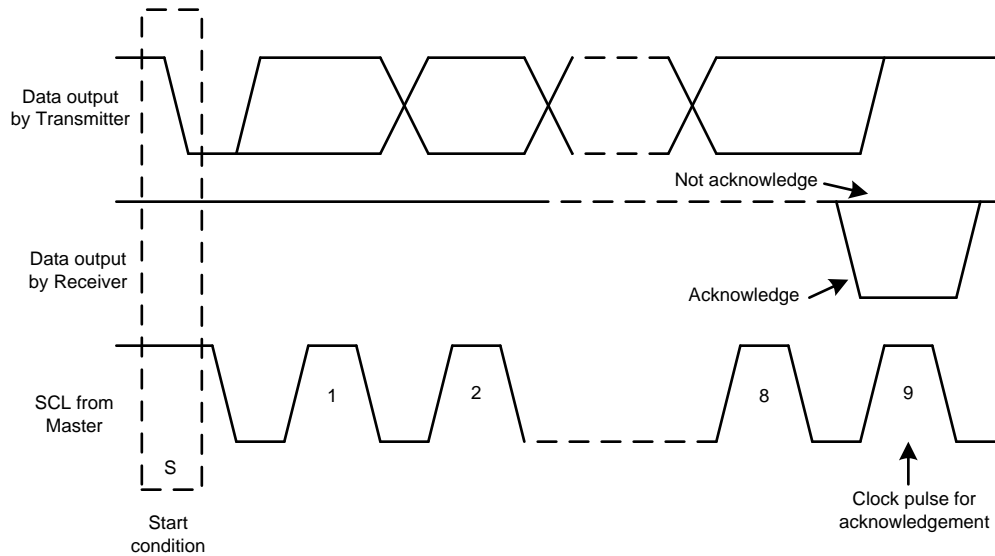

Figure 56. Acknowledge and Not Acknowledge on the I<sup>2</sup>C™ Bus

8.5.1 F/S Mode Protocol

1. The master initiates data transfer by generating a start condition. The start condition is when a high to-low transition occurs on the SDA line while SCL is high, as shown in Figure 57. All I<sup>2</sup>C™ compatible devices recognize a start condition.

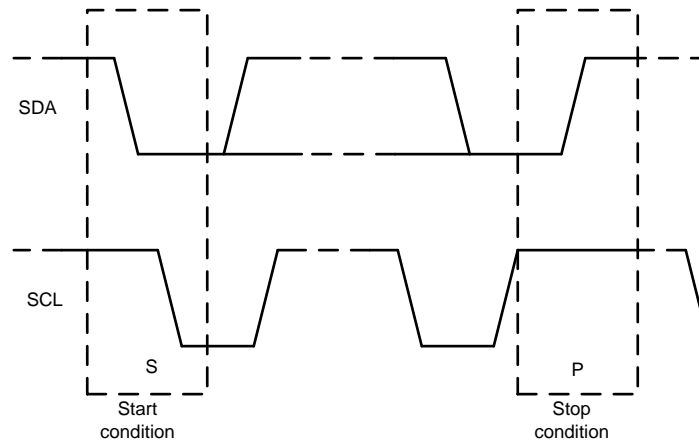
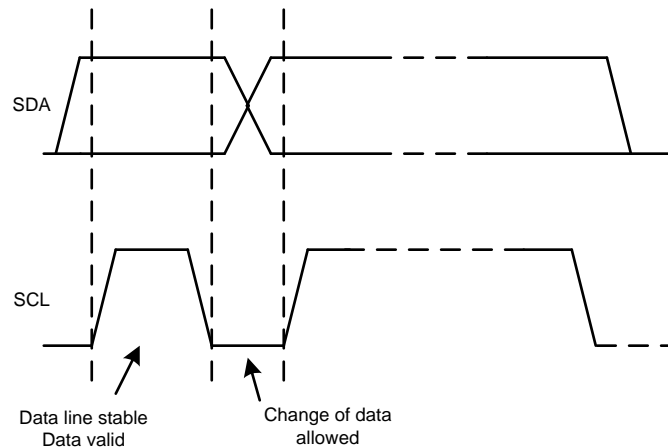

Figure 57. Start and Stop Conditions

**Programming (continued)**

**Figure 58. Bit Transfer on the I<sup>2</sup>C™ Bus**

2. The master then generates the SCL pulses, and transmits the 7-bit address and the read/write direction bit (R/W) on the SDA line. During all transmissions, the master ensures that data is valid. A valid data condition requires the SDA line to be stable during the entire high period of the clock pulse, as shown in [Figure 58](#). All devices recognize the address sent by the master and compare it to their internal fixed addresses. Only the slave device with a matching address generates an acknowledge by pulling the SDA line low during the entire high period of the 9<sup>th</sup> SCL cycle, as shown in [Figure 56](#) by pulling the SDA line low during the entire high period of the 9<sup>th</sup> SCL cycle. Upon detecting this acknowledge, the master knows the communication link with a slave has been established.
3. The master generates further SCL cycles to transmit (R/W bit 0) or receive (R/W bit 1) data to the slave. In either case, the receiver must acknowledge the data sent by the transmitter. So the acknowledge signal can be generated by the master or by the slave, depending on which one is the receiver. The 9-bit valid data sequences consists of 8-data bits and 1 acknowledge-bit, and can continue as long as necessary.
4. To signal the end of the data transfer, the master generates a stop condition by pulling the SDA line from low to high while the SCL line is high (see [Figure 57](#)). This action releases the bus and stops the communication link with the addressed slave. All I<sup>2</sup>C™-compatible devices recognize the stop condition. Upon receipt of a stop condition, the bus is released, and all slave devices then wait for a start condition followed by a matching address.

## Programming (continued)

### 8.5.2 DACx3608 I<sup>2</sup>C™ Update Sequence

For a single update, the DACx3608 requires a start condition, a valid I<sup>2</sup>C™ address byte, a command byte, and two data bytes ( the most significant data byte (MSDB) and least significant data byte (LSDB)), as listed in Table 1.

Table 1. Update Sequence

MSB	....	LSB	ACK	MSB	...	LSB	ACK	MSB	...	LSB	ACK	MSB	...	LSB	ACK
Address (A) byte				Command byte				MSDB				LSDB			
DB [32:24]				DB [23:16]				DB [15:8]				DB [7:0]			

After each byte is received, the DACx3608 family acknowledges the byte by pulling the SDA line low during the high period of a single clock pulse, as shown in Figure 59. These four bytes and acknowledge cycles make up the 36 clock cycles required for a single update to occur. A valid I<sup>2</sup>C™ address byte selects the DACx3608 devices.

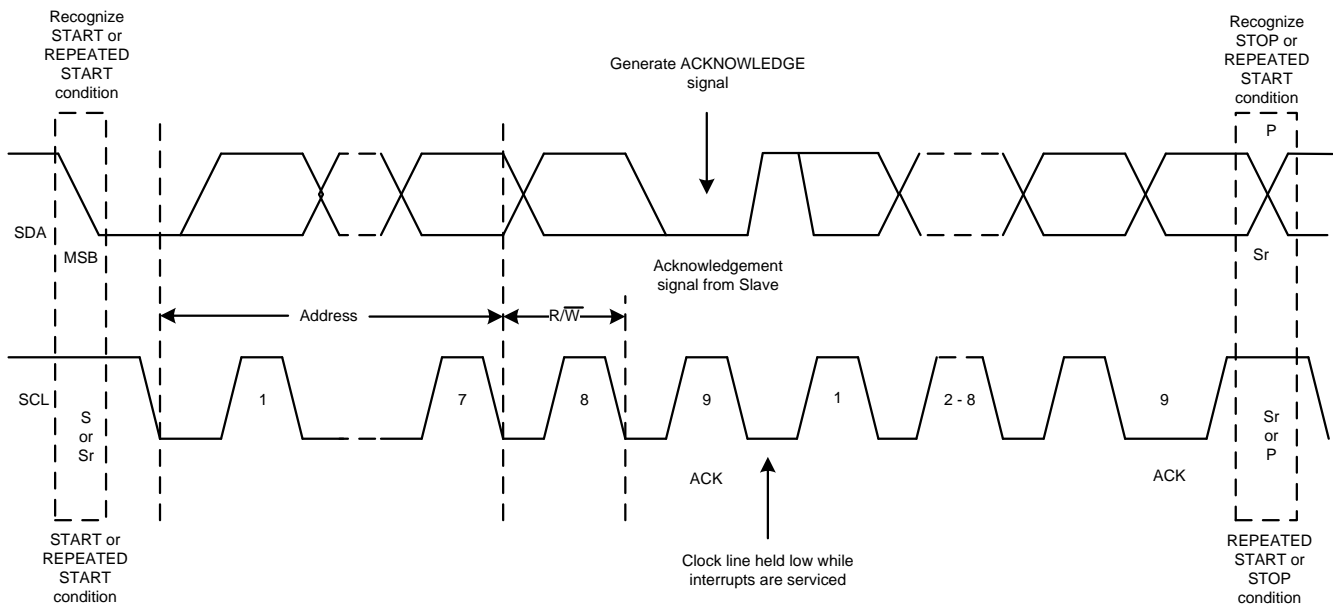

Figure 59. I<sup>2</sup>C™ Bus Protocol

The command byte sets the operational mode of the selected DACx3608 device. When the operational mode is selected by this byte, the DACx3608 series must receive two data bytes, the most significant data byte (MSDB) and least significant data byte (LSDB), for a data update to occur. The DACx3608 devices perform an update on the falling edge of the acknowledge signal that follows the LSDB.

When using fast mode (clock = 400 kHz), the maximum DAC update rate is limited to 22.22 kSPS. Using the fast+ mode (clock = 1 MHz), the maximum DAC update rate is limited to 55.55 kSPS. When a stop condition is received, the DACx3608 family releases the I<sup>2</sup>C™ bus and awaits a new start condition.

### 8.5.3 DACx3608 Address Byte

The address byte, as shown in Table 2, is the first byte received following the START condition from the master device. The first four bits (MSBs) of the address are factory preset to 1001. The next 3 bits of the address are controlled by the A0 pin. The A0 pin input can be connected to V<sub>DD</sub>, A<sub>GND</sub>, SCL, or SDA. The A0 pin is sampled during the first byte of each data frame to determine the address. The device latches the value of the address pin and consequently will respond to that particular address according to Table 3.

The DACx3608 family supports broadcast addressing. Broadcast addressing can be used for synchronously updating or powering down multiple DACx3608 devices. The DACx3608 family is designed to work with other members of the family to support multichip synchronous update. Using the broadcast address, the DACx3608 devices respond regardless of the states of the address pins. Broadcast is supported only in write mode.

**Table 2. DACx3608 Address Byte**

COMMENT	MSB							LSB
	AD6	AD5	AD4	AD3	AD2	AD1	AD0	R/ $\bar{W}$
General address	1	0	0	1	See <a href="#">Table 3</a> (slave address column)			0 or 1
Broadcast address	1	0	0	0	1	1	1	0

**Table 3. Address Format**

SLAVE ADDRESS	A0 PIN
1001 000	A <sub>GND</sub>
1001 001	V <sub>DD</sub>
1001 010	SDA
1001 011	SCL

### 8.5.4 DACx3608 Command Byte

The DACx3608 command byte (shown in [Table 4](#)) controls which command is executed and which register is being accessed when writing to or reading from the DACx3608 series.

**Table 4. DACx3608 Command Byte**

B23	B22	B21	B20	B19	B18	B17	B16	COMMENT
0	0	0	0	0	0	0	1	DEVICE_CONFIG
0	0	0	0	0	0	1	0	STATUS/TRIGGER
0	0	0	0	0	0	1	1	BRDCAST
0	0	0	0	1	0	0	0	DACA_DATA
0	0	0	0	1	0	0	1	DACB_DATA
0	0	0	0	1	0	1	0	DACC_DATA
0	0	0	0	1	0	1	1	DACD_DATA
0	0	0	0	1	1	0	0	DACE_DATA
0	0	0	0	1	1	0	1	DACF_DATA
0	0	0	0	1	1	1	0	DACG_DATA
0	0	0	0	1	1	1	1	DACH_DATA

### 8.5.5 DACx3608 Data Byte (MSDB and LSDB)

The MSDB and LSDB contain the data that are passed to the register(s) specified by the command byte as shown in [Table 5](#). The DACx3608 family updates at the falling edge of the acknowledge signal that follows the LSDB[0] bit.

**Table 5. DACx3608 Data Byte**

COMMAND BITS	DATA BITS												
	MSDB					LSDB							
B19 - B16	B15 - B12	B11	B10	B9	B8	B7	B6	B5	B4	B3	B2	B1	B0
DEVICE_CONFIG	x	0	0	0	PD N- All	PDNH	PDNG	PDNF	PDNE	PDND	PDNC	PDNB	PDNA
STATUS/TRIGGER	x	DEVICE_ID						x	x	SW_RST			
BRDCAST	x	BRDCAST_DATA[9:0] / BRDCAST_DATA[7:0] – MSB left aligned										x	x
DACA_DATA	x	DACA_DATA[9:0] / DACA_DATA[7:0] – MSB left aligned										x	x
DACB_DATA	x	DACB_DATA[9:0] / DACB_DATA[7:0] – MSB left aligned										x	x
DACC_DATA	x	DACC_DATA[9:0] / DACC_DATA[7:0] – MSB left aligned										x	x
DACD_DATA	x	DACD_DATA[9:0] / DACD_DATA[7:0] – MSB left aligned										x	x
DACE_DATA	x	DACE_DATA[9:0] / DACE_DATA[7:0] – MSB left aligned										x	x
DACF_DATA	x	DACF_DATA[9:0] / DACF_DATA[7:0] – MSB left aligned										x	x
DACG_DATA	x	DACG_DATA[9:0] / DACG_DATA[7:0] – MSB left aligned										x	x
DACH_DATA	x	DACH_DATA[9:0] / DACH_DATA[7:0] – MSB left aligned										x	x

### 8.5.6 DACx3608 I<sup>2</sup>C™ Read Sequence

To read any register the following command sequence must be used:

1. Send a start or repeated start command with a slave address and the  $\overline{R/W}$  bit set to 0 for writing. The device acknowledges this event.
2. Send a command byte for the register to be read. The device acknowledges this event again.
3. Send a repeated start with the slave address and the  $\overline{R/W}$  bit set to '1' for reading. The device acknowledges this event.
4. The device writes the MSDB byte of the addressed register. The master must acknowledge this byte.
5. Finally, the device writes out the LSDB of the register.

An alternative reading method allows for reading back the value of the last register written. The sequence is a start or repeated start with the slave address and the R/W bit set to 1, and the two bytes of the last register are read out. All the registers in DACx3608 family can be read out with the exception of SW-RST register. [Table 5](#) shows the read command set.

Note that it is not possible to use the broadcast address for reading.

**Table 6. Read Sequence**

S	MSB	...	R/W (0)	ACK	MSB	...	LSB	ACK	Sr	MSB	...	R/W (1)	ACK	MSB	...	LSB	ACK	MSB	...	LSB	ACK
	ADDRESS BYTE				COMMAND BYTE				Sr	ADDRESS BYTE				MSDB				LSDB			
	From Master			Slave	From Master			Slave		From Master			Slave	From Slave			Master	From Slave			Master

## 8.6 Register Map

**Table 7. Register Address**

B23	B22	B21	B20	B19	B18	B17	B16	COMMENT
0	0	0	0	0	0	0	1	DEVICE_CONFIG
0	0	0	0	0	0	1	0	STATUS/TRIGGER
0	0	0	0	0	0	1	1	BRDCAST
0	0	0	0	1	0	0	0	DACA_DATA
0	0	0	0	1	0	0	1	DACB_DATA
0	0	0	0	1	0	1	0	DACC_DATA
0	0	0	0	1	0	1	1	DACD_DATA
0	0	0	0	1	1	0	0	DACE_DATA
0	0	0	0	1	1	0	1	DACF_DATA
0	0	0	0	1	1	1	0	DACG_DATA
0	0	0	0	1	1	1	1	DACH_DATA

**Table 8. Register Map**

COMMAND BITS	DATA BITS													
	MSDB					LSDB								
B19 - B16	B15 - B12	B11	B10	B9	B8	B7	B6	B5	B4	B3	B2	B1	B0	
DEVICE_CONFIG	x	0	0	0	PD N- All	PDNH	PDNG	PDNF	PDNE	PDND	PDNC	PDNB	PDNA	
STATUS/TRIGGER	x	DEVICE_ID						x	x	SW_RST				
BRDCAST	x	BRDCAST_DATA[9:0] / BRDCAST_DATA[7:0] – MSB left aligned										x	x	
DACA_DATA	x	DACA_DATA[9:0] / DACA_DATA[7:0] – MSB left aligned										x	x	
DACB_DATA	x	DACB_DATA[9:0] / DACB_DATA[7:0] – MSB left aligned										x	x	
DACC_DATA	x	DACC_DATA[9:0] / DACC_DATA[7:0] – MSB left aligned										x	x	
DACD_DATA	x	DACD_DATA[9:0] / DACD_DATA[7:0] – MSB left aligned										x	x	
DACE_DATA	x	DACE_DATA[9:0] / DACE_DATA[7:0] – MSB left aligned										x	x	
DACF_DATA	x	DACF_DATA[9:0] / DACF_DATA[7:0] – MSB left aligned										x	x	
DACG_DATA	x	DACG_DATA[9:0] / DACG_DATA[7:0] – MSB left aligned										x	x	
DACH_DATA	x	DACH_DATA[9:0] / DACH_DATA[7:0] – MSB left aligned										x	x	

**Table 9. DACx3608 Register Names**

OFFSET	ACRONYM	REGISTER NAME	SECTION
01h	DEVICE_CONFIG	Device Configuration Register	<a href="#">DEVICE_CONFIG Register (offset = 01h) [reset = 00FFh]</a>

**Table 9. DACx3608 Register Names (continued)**

OFFSET	ACRONYM	REGISTER NAME	SECTION
02h	STATUS/TRIGGER	Status and Trigger Register	STATUS/TRIGGER Register (offset = 02h) [reset = 0300h for DAC53608, reset = 0500h for DAC43608]
03h	BRDCAST	Broadcast Data Register	BRDCAST Register (offset = 03h) [reset = 0000h]
08h - 0Fh	DACn_DATA	DACn Data Register	DACn_DATA Register (offset = 08h to 0Fh) [reset = 0000h]

**8.6.1 DEVICE\_CONFIG Register (offset = 01h) [reset = 00FFh]**
**Figure 60. DEVICE\_CONFIG Register**

15	14	13	12	11	10	9	8	7	6	5	4	3	2	1	0
Don't Care			0	0	0	PDN- All	PDNH	PDNG	PDNF	PDNE	PDND	PDNC	PDNB	PDNA	
$\bar{W}$										$R/\bar{W}$					

**Table 10. DEVICE\_CONFIG Register Field Descriptions**

BIT	FIELD	TYPE	RESET	DESCRIPTION
15-12	Don't Care	$\bar{W}$	0h	Don't Care
11-9	RESERVED	$\bar{W}$	00	Reserved
8	PDN-All	$R/\bar{W}$	0	Global power down bit, When set to '1', all channels and all bias blocks are powered down
7-0	PDNn	$R/\bar{W}$	FFh	DACn in power down mode (Output buffers power down 10K to $A_{GND}$ ) when this bit is set to '1' (default). At power-up all output channels buffer amplifiers start in power down to 10K mode until a power up command is issue by writing 0 to these registers.

**8.6.2 STATUS/TRIGGER Register (offset = 02h) [reset = 0300h for DAC53608, reset = 0500h for DAC43608]**
**Figure 61. STATUS/TRIGGER Register**

15	14	13	12	11	10	9	8	7	6	5	4	3	2	1	0
Don't Care			DEVICE_ID						Don't Care	Don't Care	SW_RST				
$\bar{W}$			R						$\bar{W}$	$\bar{W}$	$\bar{W}$				

**Table 11. STATUS/TRIGGER Register Field Descriptions**

BIT	FIELD	TYPE	RESET	DESCRIPTION
15-12	Don't Care	$\bar{W}$	0h	Don't Care
11-6	DEVICE_ID	R	DAC536 08: 001100 DAC436 08: 010100	Device Identification number DAC53608: 001100 DAC43608: 010100
5-4	Don't Care	$\bar{W}$	0h	Don't Care
3-0	SW_RST	$\bar{W}$	0h	Device resets to default value when this register is set to 1010

**8.6.3 BRDCAST Register (offset = 03h) [reset = 0000h]**

**Figure 62. BRDCAST Register**

15	14	13	12	11	10	9	8	7	6	5	4	3	2	1	0
Don't Care				BRDCAST_DATA[9:0] / BRDCAST_DATA[7:0] – MSB Left aligned										Don't Care	Don't Care
$\bar{W}$				$\bar{W}$										$\bar{W}$	$\bar{W}$

**Table 12. BRDCAST Register Field Descriptions**

BIT	FIELD	TYPE	RESET	DESCRIPTION
15-12	Don't Care	$\bar{W}$	0h	Don't Care
11-2	BRDCAST_DATA[9:0] / BRDCAST_DATA[7:0]	$\bar{W}$	000h	Writing to the BRDCAST register forces the DAC channel to update its active register data to the BRDCAST_DATA one. Data is MSB aligned in straight binary format and follows the format below: DAC53608: { DATA[9:0] } DAC43608: { DATA[7:0], x, x } x – Don't care bits
1-0	Don't Care	$\bar{W}$	00	Don't Care

#### 8.6.4 DACn\_DATA Register (offset = 08h to 0Fh) [reset = 0000h]

**Figure 63. DACn\_DATA Register**

15	14	13	12	11	10	9	8	7	6	5	4	3	2	1	0
Don't Care				BRDCAST_DATA[9:0] / BRDCAST_DATA[7:0] – MSB Left aligned										Don't Care	Don't Care
$\bar{W}$				$\bar{W}$										$\bar{W}$	$\bar{W}$

**Table 13. DACn\_DATA Register Field Descriptions**

BIT	FIELD	TYPE	RESET	DESCRIPTION
15-12	Don't Care	$\bar{W}$	0h	Don't Care
11-2	DACn_DATA[9:0] / DACn_DATA[7:0]	$\bar{W}$	000h	Writing to the DACn_DATA register forces the respective DAC channel to update its active register data to the DACn_DATA. Data is MSB aligned in straight binary format and follows the format below: DAC53608: { DATA[9:0] } DAC43608: { DATA[7:0], x, x } x – Don't care bits
1-0	Don't Care	$\bar{W}$	00	Don't Care

## 9 Application and Implementation

### NOTE

Information in the following applications sections is not part of the TI component specification, and TI does not warrant its accuracy or completeness. TI's customers are responsible for determining suitability of components for their purposes. Customers should validate and test their design implementation to confirm system functionality.

### 9.1 Application Information

The DACx3608 is a buffered output, 8-channel, low power DAC available in a tiny 3X3 package. The multi-channel, low power, and small package makes this DAC suitable for general purpose applications in wide range of end equipments. Some of the most common applications for this devices are LED biasing in multi-function printers, power supply supervision with programmable comparators, offset and gain trimming in precision circuits, and power supply margining.

### 9.2 Typical Applications

#### 9.2.1 Programmable LED Biasing

End equipments such as multi-function printers, projectors and electronic point-of-sale (EPOS) require a steady luminous intensity from the LED. Figure 64 shows a simplified circuit diagram for biasing an LED using DACx3608.

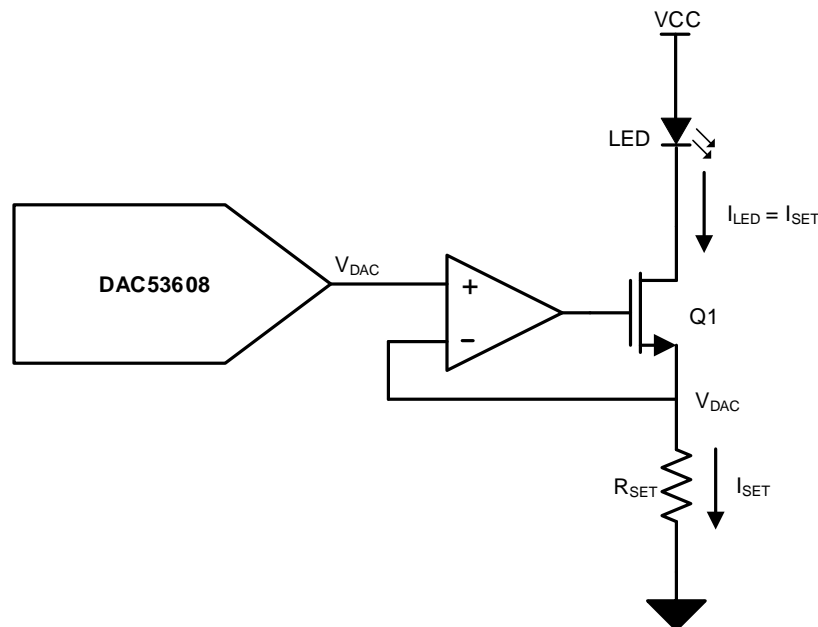

Figure 64. LED Biasing

#### 9.2.1.1 Design Requirements

- Programmable Constant Current through an LED tied to power supply on one end
- DAC Output Range: 0 – 5 V
- LED Current Range: 0 – 20 mA

## Typical Applications (continued)

### 9.2.1.2 Detailed Design Procedure

The DAC is used to set the source current of a MOSFET using a unity-gain buffer as shown in [Figure 64](#). The LED is connected between the power supply and the drain of the MOSFET. This configuration allows the DAC to control or set the amount of current through the LED. The buffer following the DAC controls the gate-source voltage of the MOSFET inside the feedback loop thus compensating this drop and corresponding drift due to temperature, current, and ageing of the MOSFET. The current set by the DAC that flows through the LED can be calculated with [Equation 2](#). In order to generate 0 – 20mA from a 0 – 5 V DAC output range, a 250-Ω  $R_{SET}$  is required.

$$I_{SET} = \frac{V_{DAC}}{R_{SET}} \quad (2)$$

The pseudocode for getting started with the LED biasing application is given below.

```
//SYNTAX: WRITE <REGISTER NAME(Hex Code)>, <DATA>
//Power-up the device and channels
WRITE DEVICE_CONFIG(0x01), 0x0000
//Program mid code (or the desired voltage) on all channels
WRITE DACA_DATA(0x08), 0x07FC //10-bit MSB aligned
WRITE DACB_DATA(0x09), 0x07FC //10-bit MSB aligned
WRITE DACC_DATA(0x0A), 0x07FC //10-bit MSB aligned
WRITE DACD_DATA(0x0B), 0x07FC //10-bit MSB aligned
WRITE DACE_DATA(0x0C), 0x07FC //10-bit MSB aligned
WRITE DACF_DATA(0x0D), 0x07FC //10-bit MSB aligned
WRITE DACG_DATA(0x0E), 0x07FC //10-bit MSB aligned
WRITE DACH_DATA(0x0F), 0x07FC //10-bit MSB aligned
```

### 9.2.1.3 Application Curve

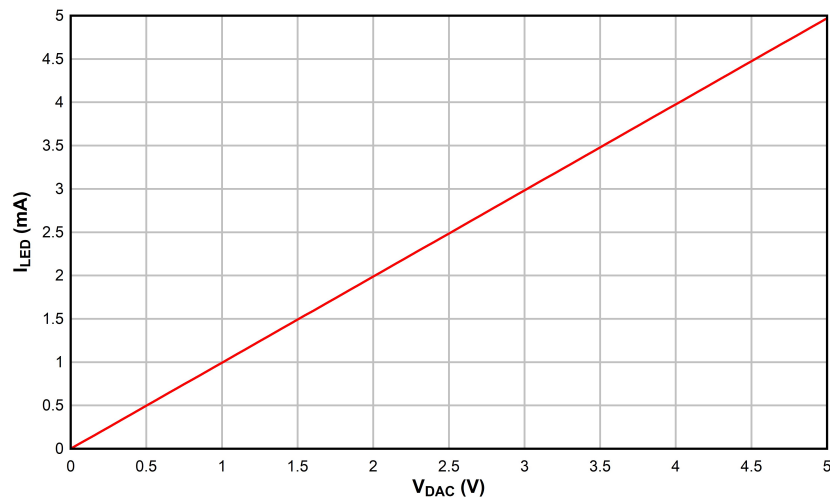

Figure 65. DC Transfer Characteristics of LED Biasing Circuit

## Typical Applications (continued)

### 9.2.2 Programmable Window Comparator

End equipments that use a centralized power supply such as network servers, optical modules, and others require the monitoring of power buses in order to protect the components. This monitoring or supervision is accomplished using a window comparator. A window comparator monitors a signal input for upper and lower threshold violations. A trigger signal is generated when the threshold violations occur. Multi-channel monitoring is required in order to supervise all power supplies available in a module. DACx3608 provides a easy to use, low-footprint method to address this requirement.

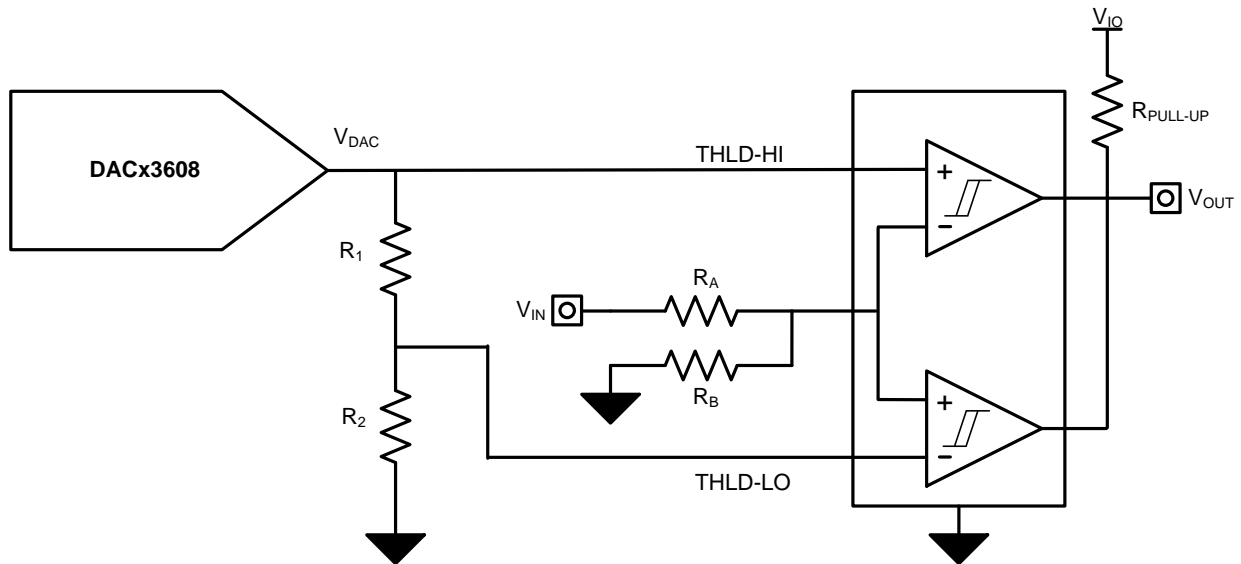

Figure 66. Programmable Window Comparator

#### 9.2.2.1 Design Requirements

- Voltage to be Monitored: 5 V
- High Threshold: 5 V + 10%
- Low Threshold: 5 V – 10%
- Trigger Output: 3.3-V Open-Drain Single Output

#### 9.2.2.2 Detailed Design Procedure

Figure 66 provides an example in which single DAC channel is used to compare both high and low thresholds. A dual comparator is used per DAC channel as shown. A voltage divider formed by resistors  $R_A$  and  $R_B$  are used in order to bring the signal level within the DAC range. Another pair of resistors  $R_1$  and  $R_2$  are used for setting the low threshold as a factor of the high threshold. This configuration allows the use of a single DAC channel for monitoring both high and low threshold levels. The comparators should be open-drain in order to provide the following advantages.

- Generate a logic output level suitable for the monitoring processor
- Allow shorting of the two outputs in order to generate a single trigger

In the circuit depicted in Figure 66 the output of the circuit remains HIGH as long as the signal input remains within the high and low threshold levels. Upon violation of any one threshold, the output goes LOW. Equation 3 provides the derivation of the low threshold voltage from the high threshold set by the DAC.

$$V_{\text{THLD-LO}} = V_{\text{DAC}} \times \left( \frac{R_2}{R_1 + R_2} \right) \quad (3)$$

## Typical Applications (continued)

In order to monitor a power supply of 5 V within  $\pm 10\%$ , it is recommended to place the nominal value at the DAC mid code. The output range of DACx3608 to be 0 – 5 V, thus the mid code voltage output is 2.5 V. Hence,  $R_A$  and  $R_B$  can be chosen in such a way that the voltage to be compared is 2.5 V. For this example,  $R_A$  is equal to  $R_B$  and we can use 10-k $\Omega$  resistors for both of them. One channel of the DACx3608 must be programmed to  $V_{THLD-HI}$ , for example  $2.5\text{ V} + 5\% = 2.625\text{ V}$ . This corresponds to a 10-bit DAC code of  $(2^{10} \div 5\text{ V}) \times 2.625\text{ V} = 537.6$  (0x21 Ah). In order to generate  $V_{THLD-LO}$  (for example,  $2.5\text{ V} - 5\% = 2.405\text{ V}$ ) from 2.625 V, the values of  $R_1$  and  $R_2$  can be calculated as 7.5 k $\Omega$  and 82 k $\Omega$ , respectively using Equation 3. The pseudocode for getting started with the programmable window comparator application with the desired DAC value is given below.

```
//SYNTAX: WRITE <REGISTER NAME (Hex Code)>, <DATA>
//Power-up the device and channels
WRITE DEVICE_CONFIG(0x01), 0x0000
//Program 2.625V on channel A
WRITE DACA_DATA(0x08), 0x0868 //10-bit MSB aligned
```

### 9.2.2.3 Application Curve

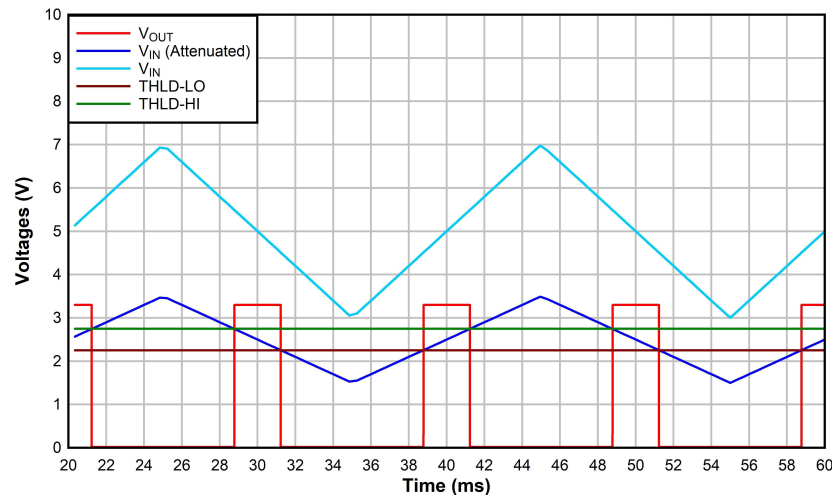

Figure 67. Programmable Comparator Output Waveform

## 10 Power Supply Recommendations

The DACx3608 family of devices does not require specific supply sequencing. It requires a single power supply,  $V_{DD}$ . A 0.1- $\mu\text{F}$  decoupling capacitor is recommended for the  $V_{DD}$  pin.

## 11 Layout

### 11.1 Layout Guidelines

The DACx3608 pinout separates the analog, digital, and power pins for an optimized layout. For signal integrity, it is recommended that digital and analog traces be separated and decoupling capacitors placed close with the device pins.

### 11.2 Layout Example

Figure 68 shows an example layout drawing with decoupling capacitors and pull-up resistors.

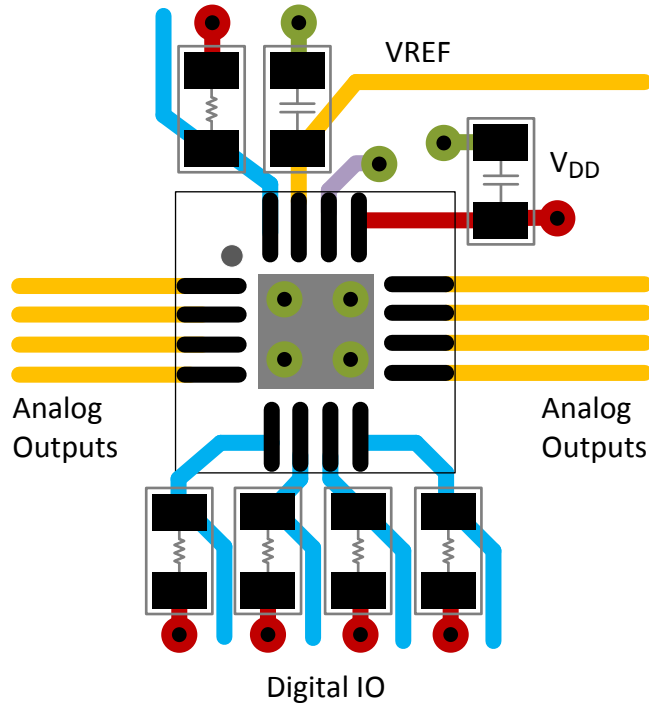

Figure 68. Layout Example

## 12 Device and Documentation Support

### 12.1 Documentation Support

#### 12.1.1 Related Documentation

For related documentation see the following: *DAC53608EVM User's Guide* ([SLAU790](#))

### 12.2 Related Links

The table below lists quick access links. Categories include technical documents, support and community resources, tools and software, and quick access to sample or buy.

**Table 14. Related Links**

PARTS	PRODUCT FOLDER	ORDER NOW	TECHNICAL DOCUMENTS	TOOLS & SOFTWARE	SUPPORT & COMMUNITY
DAC53608	<a href="#">Click here</a>	<a href="#">Click here</a>	<a href="#">Click here</a>	<a href="#">Click here</a>	<a href="#">Click here</a>
DAC43608	<a href="#">Click here</a>	<a href="#">Click here</a>	<a href="#">Click here</a>	<a href="#">Click here</a>	<a href="#">Click here</a>

### 12.3 Receiving Notification of Documentation Updates

To receive notification of documentation updates, navigate to the device product folder on ti.com. In the upper right corner, click on *Alert me* to register and receive a weekly digest of any product information that has changed. For change details, review the revision history included in any revised document.

### 12.4 Community Resources

The following links connect to TI community resources. Linked contents are provided "AS IS" by the respective contributors. They do not constitute TI specifications and do not necessarily reflect TI's views; see TI's [Terms of Use](#).

**TI E2E™ Online Community** *TI's Engineer-to-Engineer (E2E) Community*. Created to foster collaboration among engineers. At e2e.ti.com, you can ask questions, share knowledge, explore ideas and help solve problems with fellow engineers.

**Design Support** *TI's Design Support* Quickly find helpful E2E forums along with design support tools and contact information for technical support.

### 12.5 Trademarks

E2E is a trademark of Texas Instruments.  
All other trademarks are the property of their respective owners.

### 12.6 Electrostatic Discharge Caution



This integrated circuit can be damaged by ESD. Texas Instruments recommends that all integrated circuits be handled with appropriate precautions. Failure to observe proper handling and installation procedures can cause damage.

ESD damage can range from subtle performance degradation to complete device failure. Precision integrated circuits may be more susceptible to damage because very small parametric changes could cause the device not to meet its published specifications.

### 12.7 Glossary

[SLYZ022](#) — *TI Glossary*.

This glossary lists and explains terms, acronyms, and definitions.

### **13 Mechanical, Packaging, and Orderable Information**

The following pages include mechanical, packaging, and orderable information. This information is the most current data available for the designated devices. This data is subject to change without notice and revision of this document. For browser-based versions of this data sheet, refer to the left-hand navigation.

**PACKAGING INFORMATION**

Orderable part number	Status (1)	Material type (2)	Package   Pins	Package qty   Carrier	RoHS (3)	Lead finish/ Ball material (4)	MSL rating/ Peak reflow (5)	Op temp (°C)	Part marking (6)
<a href="#">DAC43608RTER</a>	Active	Production	WQFN (RTE)   16	3000   LARGE T&R	Yes	NIPDAU	Level-1-260C-UNLIM	-40 to 125	D43608
DAC43608RTER.A	Active	Production	WQFN (RTE)   16	3000   LARGE T&R	Yes	NIPDAU	Level-1-260C-UNLIM	-40 to 125	D43608
DAC43608RTERG4	Active	Production	WQFN (RTE)   16	3000   LARGE T&R	Yes	NIPDAU	Level-1-260C-UNLIM	-40 to 125	D43608
DAC43608RTERG4.A	Active	Production	WQFN (RTE)   16	3000   LARGE T&R	Yes	NIPDAU	Level-1-260C-UNLIM	-40 to 125	D43608
<a href="#">DAC43608RTET</a>	Active	Production	WQFN (RTE)   16	250   SMALL T&R	Yes	NIPDAU	Level-1-260C-UNLIM	-40 to 125	D43608
DAC43608RTET.A	Active	Production	WQFN (RTE)   16	250   SMALL T&R	Yes	NIPDAU	Level-1-260C-UNLIM	-40 to 125	D43608
<a href="#">DAC53608RTER</a>	Active	Production	WQFN (RTE)   16	3000   LARGE T&R	Yes	SN	Level-1-260C-UNLIM	-40 to 125	D53608
DAC53608RTER.A	Active	Production	WQFN (RTE)   16	3000   LARGE T&R	Yes	SN	Level-1-260C-UNLIM	-40 to 125	D53608
<a href="#">DAC53608RTET</a>	Active	Production	WQFN (RTE)   16	250   SMALL T&R	Yes	SN	Level-1-260C-UNLIM	-40 to 125	D53608
DAC53608RTET.A	Active	Production	WQFN (RTE)   16	250   SMALL T&R	Yes	SN	Level-1-260C-UNLIM	-40 to 125	D53608

(1) **Status:** For more details on status, see our [product life cycle](#).

(2) **Material type:** When designated, preproduction parts are prototypes/experimental devices, and are not yet approved or released for full production. Testing and final process, including without limitation quality assurance, reliability performance testing, and/or process qualification, may not yet be complete, and this item is subject to further changes or possible discontinuation. If available for ordering, purchases will be subject to an additional waiver at checkout, and are intended for early internal evaluation purposes only. These items are sold without warranties of any kind.

(3) **RoHS values:** Yes, No, RoHS Exempt. See the [TI RoHS Statement](#) for additional information and value definition.

(4) **Lead finish/Ball material:** Parts may have multiple material finish options. Finish options are separated by a vertical ruled line. Lead finish/Ball material values may wrap to two lines if the finish value exceeds the maximum column width.

(5) **MSL rating/Peak reflow:** The moisture sensitivity level ratings and peak solder (reflow) temperatures. In the event that a part has multiple moisture sensitivity ratings, only the lowest level per JEDEC standards is shown. Refer to the shipping label for the actual reflow temperature that will be used to mount the part to the printed circuit board.

(6) **Part marking:** There may be an additional marking, which relates to the logo, the lot trace code information, or the environmental category of the part.

Multiple part markings will be inside parentheses. Only one part marking contained in parentheses and separated by a "~" will appear on a part. If a line is indented then it is a continuation of the previous line and the two combined represent the entire part marking for that device.

**Important Information and Disclaimer:** The information provided on this page represents TI's knowledge and belief as of the date that it is provided. TI bases its knowledge and belief on information provided by third parties, and makes no representation or warranty as to the accuracy of such information. Efforts are underway to better integrate information from third parties. TI has taken and continues to take reasonable steps to provide representative

and accurate information but may not have conducted destructive testing or chemical analysis on incoming materials and chemicals. TI and TI suppliers consider certain information to be proprietary, and thus CAS numbers and other limited information may not be available for release.

In no event shall TI's liability arising out of such information exceed the total purchase price of the TI part(s) at issue in this document sold by TI to Customer on an annual basis.

**TAPE AND REEL INFORMATION**

**QUADRANT ASSIGNMENTS FOR PIN 1 ORIENTATION IN TAPE**

\*All dimensions are nominal

Device	Package Type	Package Drawing	Pins	SPQ	Reel Diameter (mm)	Reel Width W1 (mm)	A0 (mm)	B0 (mm)	K0 (mm)	P1 (mm)	W (mm)	Pin1 Quadrant
DAC43608RTER	WQFN	RTE	16	3000	330.0	12.4	3.3	3.3	1.1	8.0	12.0	Q2
DAC43608RTERG4	WQFN	RTE	16	3000	330.0	12.4	3.3	3.3	1.1	8.0	12.0	Q2
DAC43608RTET	WQFN	RTE	16	250	180.0	12.4	3.3	3.3	1.1	8.0	12.0	Q2
DAC53608RTER	WQFN	RTE	16	3000	330.0	12.4	3.3	3.3	1.1	8.0	12.0	Q2
DAC53608RTET	WQFN	RTE	16	250	180.0	12.4	3.3	3.3	1.1	8.0	12.0	Q2

**TAPE AND REEL BOX DIMENSIONS**

\*All dimensions are nominal

Device	Package Type	Package Drawing	Pins	SPQ	Length (mm)	Width (mm)	Height (mm)
DAC43608RTER	WQFN	RTE	16	3000	367.0	367.0	35.0
DAC43608RTERG4	WQFN	RTE	16	3000	367.0	367.0	35.0
DAC43608RTET	WQFN	RTE	16	250	210.0	185.0	35.0
DAC53608RTER	WQFN	RTE	16	3000	367.0	367.0	35.0
DAC53608RTET	WQFN	RTE	16	250	210.0	185.0	35.0

## GENERIC PACKAGE VIEW

**RTE 16**

**WQFN - 0.8 mm max height**

3 x 3, 0.5 mm pitch

PLASTIC QUAD FLATPACK - NO LEAD

This image is a representation of the package family, actual package may vary.  
Refer to the product data sheet for package details.

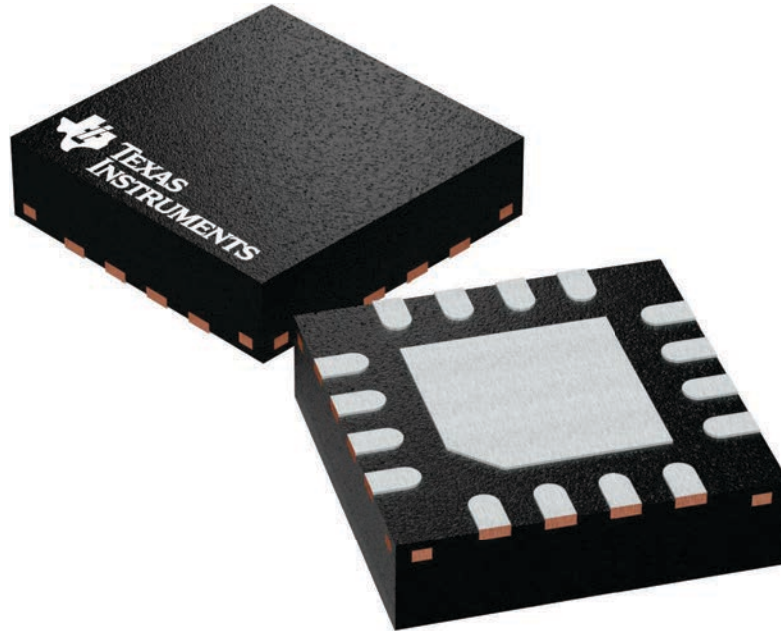

4225944/A

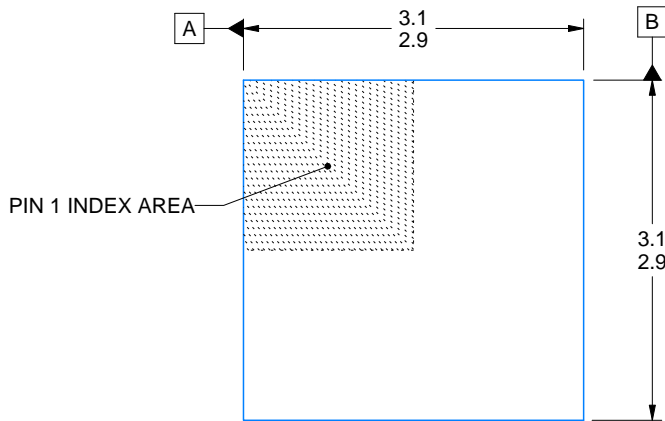

SIDE WALL METAL THICKNESS DIM A	
OPTION 1	OPTION 2
0.1	0.2

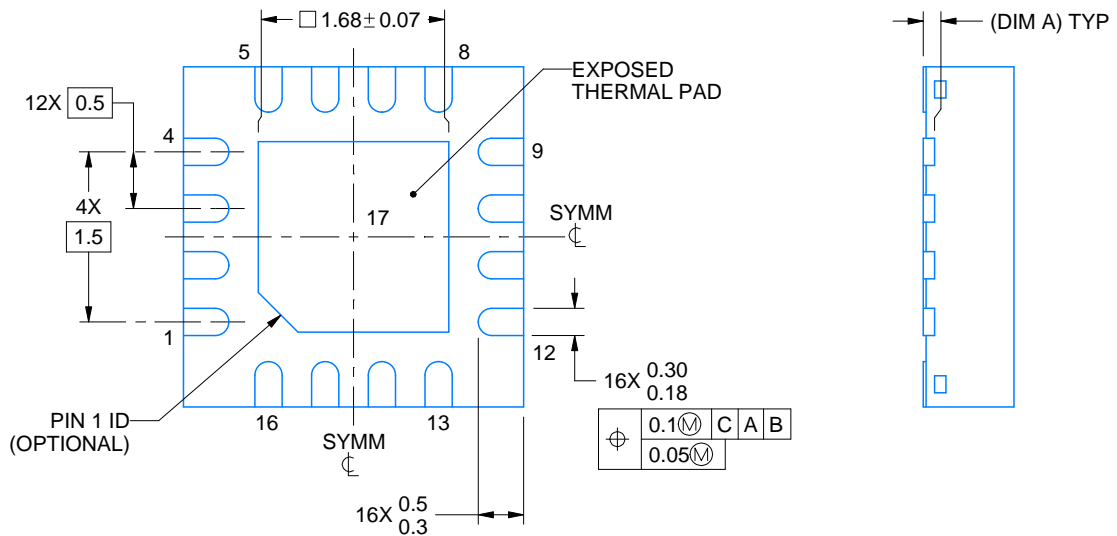
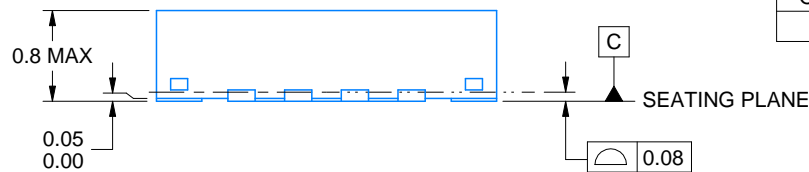

4219117/B 04/2022

NOTES:

1. All linear dimensions are in millimeters. Any dimensions in parenthesis are for reference only. Dimensioning and tolerancing per ASME Y14.5M.
2. This drawing is subject to change without notice.
3. The package thermal pad must be soldered to the printed circuit board for thermal and mechanical performance.

# EXAMPLE BOARD LAYOUT

RTE0016C

WQFN - 0.8 mm max height

PLASTIC QUAD FLATPACK - NO LEAD

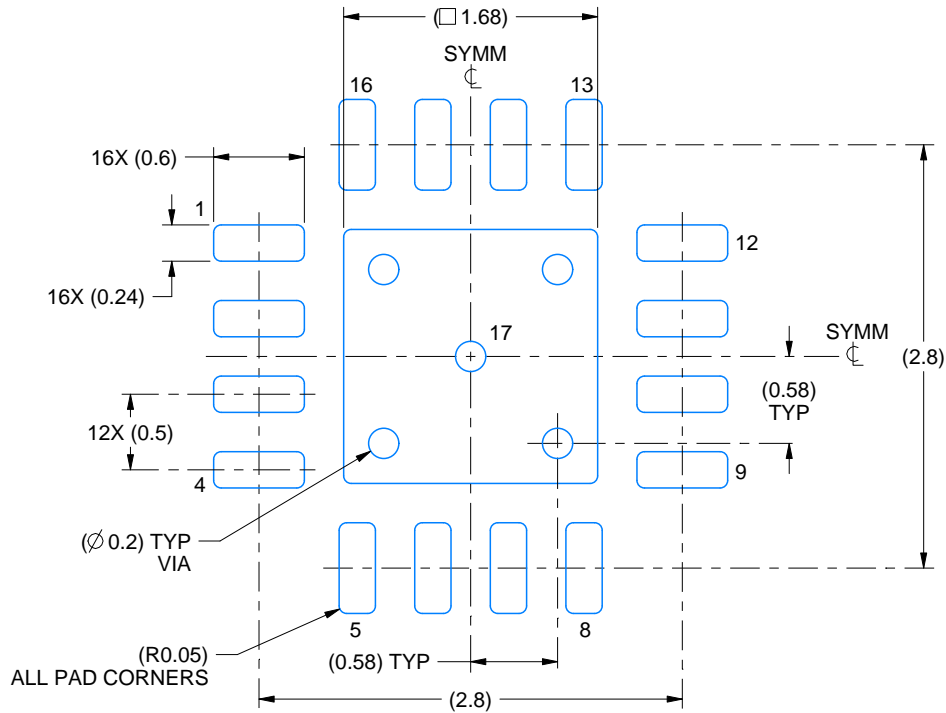

LAND PATTERN EXAMPLE  
EXPOSED METAL SHOWN  
SCALE:20X

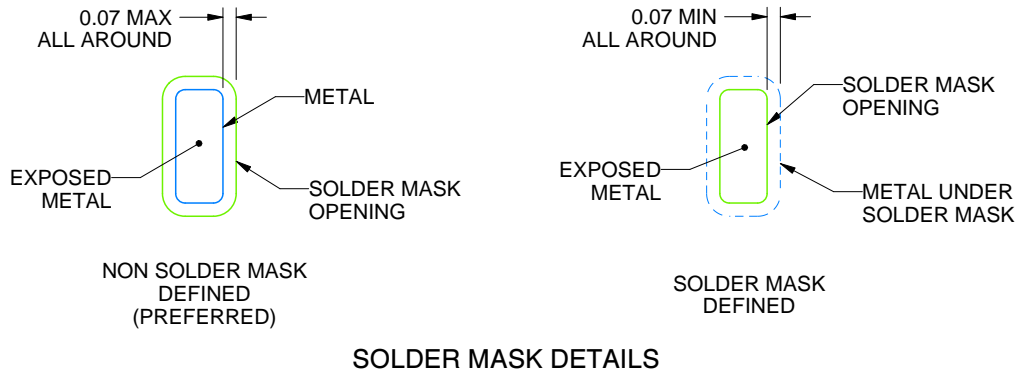

SOLDER MASK DETAILS

4219117/B 04/2022

NOTES: (continued)

- This package is designed to be soldered to a thermal pad on the board. For more information, see Texas Instruments literature number SLUA271 ([www.ti.com/lit/sluea271](http://www.ti.com/lit/sluea271)).
- Vias are optional depending on application, refer to device data sheet. If any vias are implemented, refer to their locations shown on this view. It is recommended that vias under paste be filled, plugged or tented.

# EXAMPLE STENCIL DESIGN

RTE0016C

WQFN - 0.8 mm max height

PLASTIC QUAD FLATPACK - NO LEAD

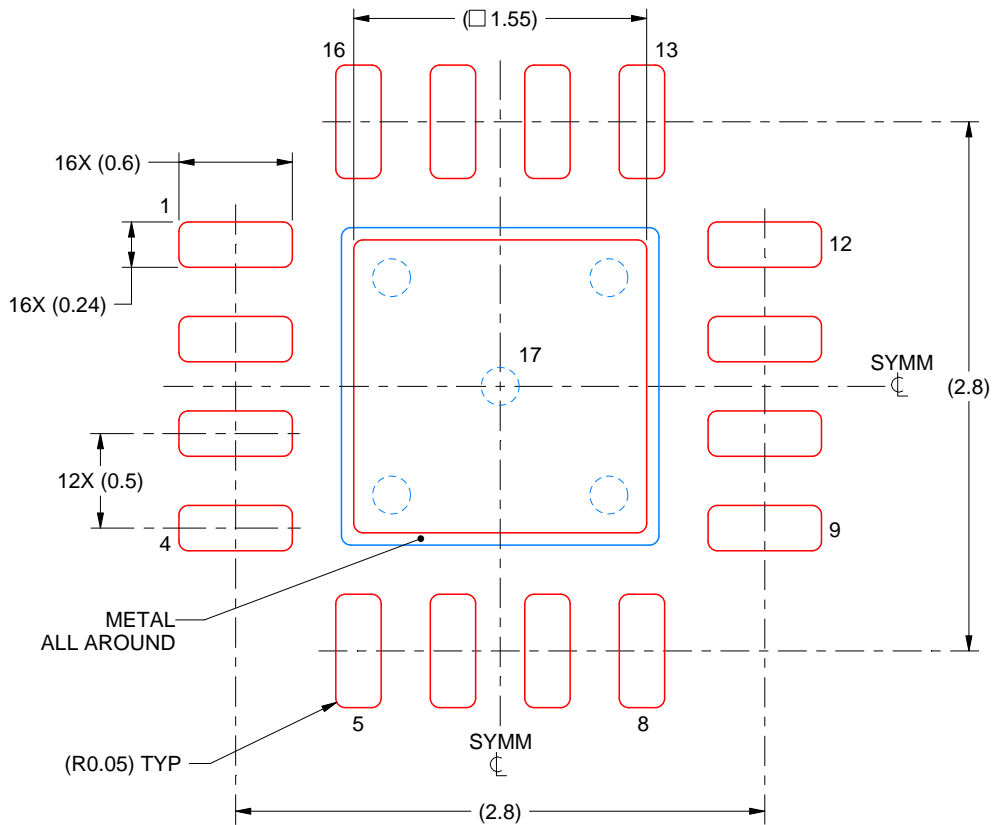

**SOLDER PASTE EXAMPLE**  
BASED ON 0.125 mm THICK STENCIL

EXPOSED PAD 17:  
85% PRINTED SOLDER COVERAGE BY AREA UNDER PACKAGE  
SCALE:25X

4219117/B 04/2022

NOTES: (continued)

6. Laser cutting apertures with trapezoidal walls and rounded corners may offer better paste release. IPC-7525 may have alternate design recommendations.

## IMPORTANT NOTICE AND DISCLAIMER

TI PROVIDES TECHNICAL AND RELIABILITY DATA (INCLUDING DATASHEETS), DESIGN RESOURCES (INCLUDING REFERENCE DESIGNS), APPLICATION OR OTHER DESIGN ADVICE, WEB TOOLS, SAFETY INFORMATION, AND OTHER RESOURCES "AS IS" AND WITH ALL FAULTS, AND DISCLAIMS ALL WARRANTIES, EXPRESS AND IMPLIED, INCLUDING WITHOUT LIMITATION ANY IMPLIED WARRANTIES OF MERCHANTABILITY, FITNESS FOR A PARTICULAR PURPOSE OR NON-INFRINGEMENT OF THIRD PARTY INTELLECTUAL PROPERTY RIGHTS.

These resources are intended for skilled developers designing with TI products. You are solely responsible for (1) selecting the appropriate TI products for your application, (2) designing, validating and testing your application, and (3) ensuring your application meets applicable standards, and any other safety, security, regulatory or other requirements.

These resources are subject to change without notice. TI grants you permission to use these resources only for development of an application that uses the TI products described in the resource. Other reproduction and display of these resources is prohibited. No license is granted to any other TI intellectual property right or to any third party intellectual property right. TI disclaims responsibility for, and you fully indemnify TI and its representatives against any claims, damages, costs, losses, and liabilities arising out of your use of these resources.

TI's products are provided subject to [TI's Terms of Sale](#), [TI's General Quality Guidelines](#), or other applicable terms available either on [ti.com](http://ti.com) or provided in conjunction with such TI products. TI's provision of these resources does not expand or otherwise alter TI's applicable warranties or warranty disclaimers for TI products. Unless TI explicitly designates a product as custom or customer-specified, TI products are standard, catalog, general purpose devices.

TI objects to and rejects any additional or different terms you may propose.

Copyright © 2026, Texas Instruments Incorporated

Last updated 10/2025