

LMG2640 Integrated 650V GaN Half Bridge

1 Features

- 650V GaN power-FET half bridge
- 105mΩ low-side and high-side GaN FETs
- Integrated gate drivers with low propagation delays
- Current-sense emulation with high-bandwidth and high accuracy
- Low-side / high-side gate-drive interlock
- High-side gate-drive signal level shifter
- Smart-switched bootstrap diode function
- High-side start up : < 8μs
- Low-side / high-side cycle-by-cycle over-current protection
- Over-temperature protection with $\overline{\text{FLT}}$ pin reporting
- AUX idle quiescent current: 250μA
- AUX standby quiescent current: 50μA
- BST idle quiescent current: 65μA
- Maximum supply and input logic pin voltage: 26V
- 9×7mm QFN package with dual thermal pads

2 Applications

- AC/DC adapters and chargers
- AC/DC USB wall outlet power supplies
- AC/DC auxiliary power supplies
- [Mobile wall charger design](#)
- [USB wall power outlet](#)

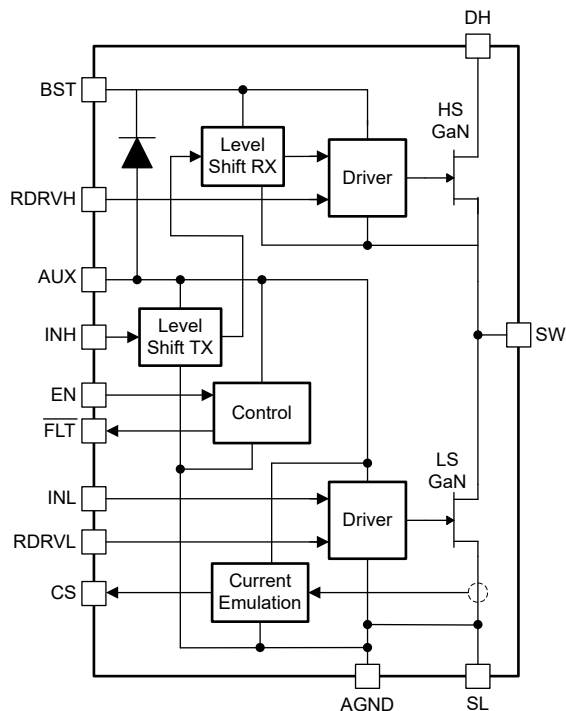

Simplified Block Diagram

3 Description

The LMG2640 is a 650V GaN power-FET half bridge intended for switch mode power supply applications. The LMG2640 simplifies design, reduces component count, and reduces board space by integrating half-bridge power FETs, gate drivers, bootstrap diode, and high-side gate-drive level shifter in a 9mm by 7mm QFN package.

The low-side current-sense emulation reduces power dissipation compared to the traditional current-sense resistor and allows the low-side thermal pad to be connected to the cooling PCB power ground.

The high-side gate-drive signal level shifter eliminates noise and burst-mode power dissipation problems found with external solutions. The smart-switched GaN bootstrap FET has no diode forward-voltage drop, avoids overcharging the high-side supply, and has zero reverse-recovery charge.

The LMG2640 supports converter light-load efficiency requirements and burst-mode operation with low quiescent currents and fast start-up times. Protection features include FET turn-on interlock, under-voltage lockout (UVLO), cycle-by-cycle current limit, and over-temperature shut down.

Package Information

PART NUMBER	PACKAGE ⁽¹⁾	PACKAGE SIZE ⁽²⁾
LMG2640	RRG (QFN, 40)	9.00mm × 7.00mm

- (1) For more information, see the [Section 11](#) section.
- (2) The package size (length × width) is a nominal value and includes pins, where applicable.

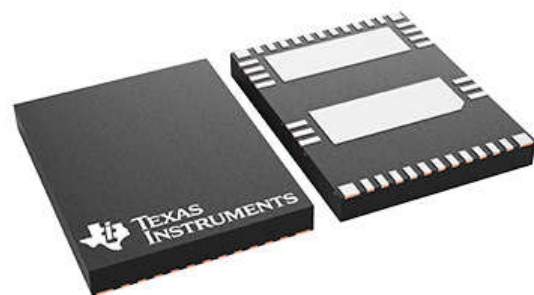

Package View



Table of Contents

1 Features	1	7.3 Feature Description.....	22
2 Applications	1	7.4 Device Functional Modes.....	28
3 Description	1	8 Application and Implementation	29
4 Pin Configuration and Functions	3	8.1 Application Information.....	29
5 Specifications	5	8.2 Typical Application.....	29
5.1 Absolute Maximum Ratings.....	5	8.3 Power Supply Recommendations.....	31
5.2 ESD Ratings.....	5	8.4 Layout.....	32
5.3 Recommended Operating Conditions.....	6	9 Device and Documentation Support	34
5.4 Thermal Information.....	6	9.1 Documentation Support.....	34
5.5 Electrical Characteristics.....	7	9.2 Receiving Notification of Documentation Updates....	34
5.6 Switching Characteristics.....	10	9.3 Support Resources.....	34
5.7 Typical Characteristics.....	13	9.4 Trademarks.....	34
6 Parameter Measurement Information	18	9.5 Electrostatic Discharge Caution.....	34
6.1 GaN Power FET Switching Parameters.....	18	9.6 Glossary.....	34
7 Detailed Description	20	10 Revision History	34
7.1 Overview.....	20	11 Mechanical, Packaging, and Orderable Information	35
7.2 Functional Block Diagram.....	21		

4 Pin Configuration and Functions

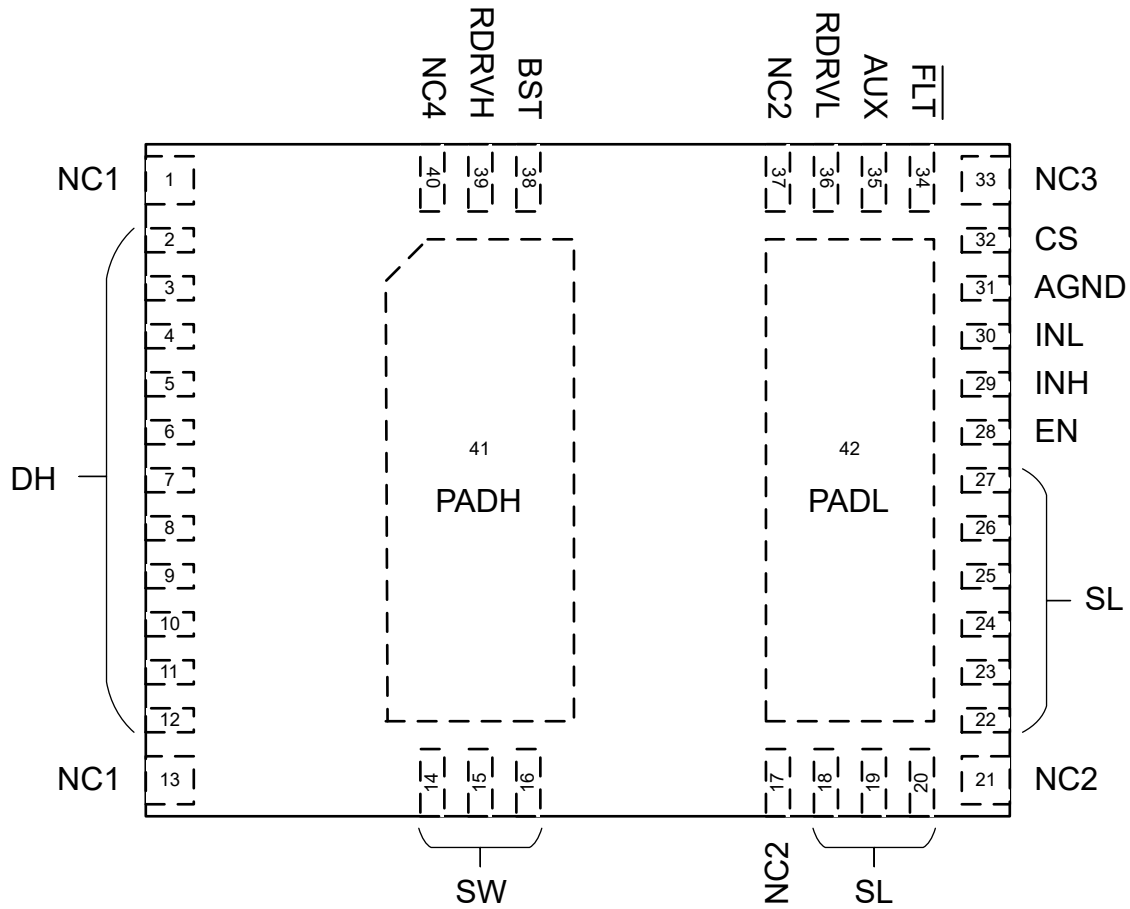

Figure 4-1. RRG Package, 40-Pin VQFN (Top View)

Table 4-1. Pin Functions

PIN		TYPE ⁽¹⁾	DESCRIPTION
NAME	NO.		
NC1	1, 13	NC	Used to anchor QFN package to PCB. Pins must be soldered to PCB landing pads. The PCB landing pads are non-solder mask defined pads and must not be physically connected to any other metal on the PCB. Internally connected to DH.
DH	2–12	P	High-side GaN FET drain. Internally connected to NC1.
SW	14–16	P	GaN FET half-bridge switch node between the high-side GaN FET source and low-side GaN FET drain. Internally connected to PADH.
NC2	17, 21, 37	NC	Used to anchor QFN package to PCB. Pins must be soldered to PCB landing pads. The PCB landing pads are non-solder mask defined pads and must not be physically connected to any other metal on the PCB. Internally connected to AGND, SL, and PADL.
SL	18–20, 22–27	P	Low-side GaN FET source. Internally connected to AGND, PADL, and NC2.
EN	28	I	Enable. Used to toggle between active and standby modes. The standby mode has reduced quiescent current to support converter light load efficiency targets. There is a forward biased ESD diode from EN to AUX so avoid driving EN higher than AUX.
INH	29	I	High-side gate-drive control input. Referenced to AGND. Signal is level shifted internally to the high-side GaN FET driver. There is a forward biased ESD diode from INH to AUX so avoid driving INH higher than AUX.
INL	30	I	Low-side gate-drive control input. Referenced to AGND. There is a forward biased ESD diode from INL to AUX so avoid driving INL higher than AUX.
AGND	31	GND	Low-side analog ground. Internally connected to SL, PADL, and NC2.
CS	32	O	Current-sense emulation output. Outputs 0.616 ma/A scaled replica of the low-side GaN FET current. Feed output current into a resistor to create a current sense voltage signal. Reference the resistor to the power supply controller IC local ground. This function replaces the external current-sense resistor that is used in series with the low-side FET.
NC3	33	NC	Used to anchor QFN package to PCB. Pin must be soldered to a PCB landing pad. The PCB landing pad is non-solder mask defined pad and must not be physically connected to any other metal on the PCB. Pin not connected internally.
FLT	34	O	Active-low fault output. Open-drain output that asserts during an over-temperature shutdown.
AUX	35	P	Auxiliary voltage rail. Low-side supply voltage. Connect a local bypass capacitor between AUX and AGND.
RDRV L	36	I	Short to AGND.
BST	38	P	Bootstrap voltage rail. High-side supply voltage. The bootstrap diode function between AUX and BST is internally provided. Connect an appropriately sized bootstrap capacitor between BST and SW. Recommend to make the SW connection using NC4 as a pass through connection to PADH (PADH = SW) as explained in the NC4 description.
RDRV H	39	I	Short to SW. Recommend to make the SW connection using NC4 as a pass through connection to PADH (PADH = SW) as explained in the NC4 description.
NC4	40	NC	Pin is not functional. Pin is high impedance and referenced to SW. Recommend to connect pin to PADH (PADH = SW) to use as convenient connection for the BST bypass capacitor and the RDRVH. See the example board layout in the Layout Example section.
PADH	41	TP	High-side thermal pad. Internally connected to SW. All the SW current can be conducted with PADH (PADH = SW).
PADL	42	TP	Low-side thermal pad. Internally connected to SL, AGND, and NC2. All the SL current can be conducted with PADL (PADL = SL).

(1) I = Input, O = Output, G = Ground, P = Power, NC = No Connect, TP = Thermal Pad.

5 Specifications

5.1 Absolute Maximum Ratings

Unless otherwise noted: voltages are respect to AGND⁽¹⁾

		MIN	MAX	UNIT	
$V_{DS(is)}$	Low-side drain-source (SW to SL) voltage, FET off		650	V	
$V_{DS(surge)(is)}$	Low-side drain-source (SW to SL) voltage, surge condition, FET off ⁽²⁾		720	V	
$V_{DS(tr)(surge)(is)}$	Low-side drain-source (SW to SL) transient ringing peak voltage, surge condition, FET off ⁽²⁾		800	V	
$V_{DS(hs)}$	High-side drain source (DH to SW) voltage, FET off		650	V	
$V_{DS(surge)(hs)}$	High-side drain-source (DH to SW) voltage, surge condition, FET off ⁽²⁾		720	V	
$V_{DS(tr)(surge)(hs)}$	High-side drain-source (DH to SW) transient ringing peak voltage, surge condition, FET off ⁽²⁾		800	V	
	Pin voltage	AUX	-0.3	30	V
		EN, INL, INH, FLT	-0.3	$V_{AUX} + 0.3$	V
		CS	-0.3	5.5	V
		RDRV L	-0.3	4	V
	Pin voltage to SW	BST	-0.3	30	V
		RDRV H	-0.3	4	V
$I_{D(cnts)(is)}$	Low-side drain (SW to SL) continuous current, FET on	-10	Internally limited	A	
$I_{S(cnts)(is)}$	Low-side source (SL to SW) continuous current, FET off		10	A	
$I_{D(cnts)(hs)}$	High-side drain (DH to SW) continuous current, FET on	-10	Internally limited	A	
$I_{S(cnts)(hs)}$	High-side source (SW to DH) continuous current, FET off		10	A	
	Positive sink current	CS		10	mA
		FLT (while asserted)		Internally limited	mA
T_J	Operating junction temperature	-40	150	°C	
T_{stg}	Storage temperature	-65	150	°C	

- Operation outside the Absolute Maximum Ratings may cause permanent device damage. Absolute Maximum Ratings do not imply functional operation of the device at these or any other conditions beyond those listed under Recommended Operating Conditions. If used outside the Recommended Operating Conditions but within the Absolute Maximum Ratings, the device may not be fully functional, and this may affect device reliability, functionality, performance, and shorten the device lifetime.
- See [Section 7.3.1](#) for more information on the GaN power FET switching capability.

5.2 ESD Ratings

			VALUE	UNIT
$V_{(ESD)}$	Electrostatic discharge	Human body model (HBM), per ANSI/ESDA/JEDEC JS-001 ⁽¹⁾	±1000	V
			±2000	V
		Charged device model (CDM), per ANSI/ESDA/JEDEC JS-002 ⁽²⁾	±500	V

- JEDEC document JEP155 states that 500-V HBM allows safe manufacturing with a standard ESD control process.
- JEDEC document JEP157 states that 250-V CDM allows safe manufacturing with a standard ESD control process.

5.3 Recommended Operating Conditions

Unless otherwise noted: voltages are respect to AGND

			MIN	NOM	MAX	UNIT
	Supply voltage	AUX	10		26	V
	Supply voltage to SW	BST	7.5		26	V
	Input voltage	EN, INL, INH	0		V _{AUX}	V
	Pull-up voltage on open-drain output	FLT	0		V _{AUX}	V
V _{IH}	High-level input voltage	EN, INL, INH	2.5			V
V _{IL}	Low-level input voltage				0.6	V
I _{D(cnts)(ls)}	Low-side drain (SW to SL) continuous current, FET on		-8.2		8.2	A
I _{D(cnts)(hs)}	High-side drain (DH to SW) continuous current, FET on		-8.2		8.2	A
C _{AUX}	AUX to AGND capacitance from external bypass capacitor		3 x C _{BST}			μF
C _{BST_SW}	BST to SW capacitance from external bypass capacitor		0.010			μF

5.4 Thermal Information

THERMAL METRIC ⁽¹⁾		LMG2640	UNIT
		RRG (VQFN)	
		40 PINS	
R _{θJA}	Junction-to-ambient thermal resistance	22.8	°C/W
R _{θJC(bot)}	Junction-to-case (bottom) thermal resistance	1.21	°C/W

- (1) For more information about traditional and new thermal metrics, see the [Semiconductor and IC Package Thermal Metrics](#) application report.

5.5 Electrical Characteristics

1) Symbol definitions: $V_{DS(is)}$ = SW to SL voltage; $I_{D(is)}$ = SW to SL current; $V_{DS(hs)}$ = DH to SW voltage; $I_{D(hs)}$ = DH to SW current; 2) Unless otherwise noted: voltage, resistance, and capacitance are respect to AGND; $-40^{\circ}\text{C} \leq T_J \leq 125^{\circ}\text{C}$; $10\text{V} \leq V_{AUX} \leq 26\text{V}$; $7.5\text{V} \leq V_{BST_SW} \leq 26\text{V}$; $V_{EN} = 5\text{V}$; $V_{INL} = 0\text{V}$; $V_{INH} = 0\text{V}$; $R_{CS} = 100\Omega$

PARAMETER		TEST CONDITIONS	MIN	TYP	MAX	UNIT
LOW-SIDE GAN POWER FET						
$R_{DS(on)(is)}$	Drain-source (SW to SL) on resistance	$V_{INL} = 5\text{V}$, $I_{D(is)} = 4.8\text{A}$, $T_J = 25^{\circ}\text{C}$		105		m Ω
		$V_{INL} = 5\text{V}$, $I_{D(is)} = 4.8\text{A}$, $T_J = 125^{\circ}\text{C}$		200		
$I_{DSS(is)}$	Drain (SW to SL) leakage current	$V_{DS(hs)} = 0\text{V}$, $V_{DS(is)} = 650\text{V}$, $T_J = 25^{\circ}\text{C}$		3.1		μA
		$V_{DS(hs)} = 0\text{V}$, $V_{DS(is)} = 650\text{V}$, $T_J = 125^{\circ}\text{C}$		15.4		
$Q_{OSS(is)}$	Output (SW to SL) charge	$V_{DS(hs)} = 0\text{V}$, $V_{DS(is)} = 400\text{V}$		33.6		nC
$C_{OSS(is)}$	Output (SW to SL) capacitance			51.0		pF
$E_{OSS(is)}$	Output (SW to SL) capacitance stored energy			4.64		μJ
$C_{OSS,er(is)}$	Energy related effective output (SW to SL) capacitance			58.0		pF
$C_{OSS,tr(is)}$	Time related effective output (SW to SL) capacitance	$V_{DS(hs)} = 0\text{V}$, $V_{DS(is)} = 0\text{V to } 400\text{V}$		84.0		pF
$Q_{RR(is)}$	Reverse recovery charge			0		nC
HIGH-SIDE GAN POWER FET						
$R_{DS(on)(hs)}$	Drain-source (DH to SW) on resistance	$V_{INH} = 5\text{V}$, $I_{D(hs)} = 4.8\text{A}$, $T_J = 25^{\circ}\text{C}$		105		m Ω
		$V_{INH} = 5\text{V}$, $I_{D(hs)} = 4.8\text{A}$, $T_J = 125^{\circ}\text{C}$		200		
$I_{DSS(hs)}$	Drain (DH to SW) leakage current	$V_{DS(is)} = 0\text{V}$, $V_{DS(hs)} = 650\text{V}$, $T_J = 25^{\circ}\text{C}$		3.1		μA
		$V_{DS(is)} = 0\text{V}$, $V_{DS(hs)} = 650\text{V}$, $T_J = 125^{\circ}\text{C}$		15.4		
$Q_{OSS(hs)}$	Output (DH to SW) charge	$V_{DS(is)} = 0\text{V}$, $V_{DS(hs)} = 400\text{V}$		33.6		nC
$C_{OSS(hs)}$	Output (DH to SW) capacitance			51.0		pF
$E_{OSS(hs)}$	Output (DH to SW) capacitance stored energy			4.64		μJ
$C_{OSS,er(hs)}$	Energy related effective output (DH to SW) capacitance			58.0		pF
$C_{OSS,tr(hs)}$	Time related effective output (DH to SW) capacitance	$V_{DS(is)} = 0\text{V}$, $V_{DS(hs)} = 0\text{V to } 400\text{V}$		84.0		pF
$Q_{RR(hs)}$	Reverse recovery charge			0		nC
LOW-SIDE OVERCURRENT PROTECTION						
$I_{T(OC)(is)}$	Overcurrent fault – threshold current		8.2	9.1	10	A
HIGH-SIDE OVERCURRENT PROTECTION						
$I_{T(OC)(hs)}$	Overcurrent fault – threshold current		8.2	9.1	10	A
BOOTSTRAP RECTIFIER						
$R_{DS(on)}$	AUX to BST on resistance	$V_{INL} = 5\text{V}$, $V_{AUX_BST} = 1\text{V}$, $T_J = 25^{\circ}\text{C}$		8		Ω
		$V_{INL} = 5\text{V}$, $V_{AUX_BST} = 1\text{V}$, $T_J = 125^{\circ}\text{C}$		14		
	AUX to BST current limit	$V_{INL} = 5\text{V}$, $V_{AUX_BST} = 7\text{V}$	210	240	270	mA
	BST to AUX reverse current blocking threshold	$V_{INL} = 5\text{V}$		15		mA

5.5 Electrical Characteristics (continued)

1) Symbol definitions: $V_{DS(is)}$ = SW to SL voltage; $I_{D(is)}$ = SW to SL current; $V_{DS(hs)}$ = DH to SW voltage; $I_{D(hs)}$ = DH to SW current; 2) Unless otherwise noted: voltage, resistance, and capacitance are respect to AGND; $-40^{\circ}\text{C} \leq T_J \leq 125^{\circ}\text{C}$; $10\text{V} \leq V_{AUX} \leq 26\text{V}$; $7.5\text{V} \leq V_{BST_SW} \leq 26\text{V}$; $V_{EN} = 5\text{V}$; $V_{INL} = 0\text{V}$; $V_{INH} = 0\text{V}$; $R_{CS} = 100\Omega$

PARAMETER		TEST CONDITIONS	MIN	TYP	MAX	UNIT
CS						
	Current sense gain ($I_{CS(src)} / I_{D(LS)}$)	$V_{INL} = 5\text{V}$, $0\text{V} \leq V_{CS} \leq 2\text{V}$, $0\text{A} \leq I_{D(is)} < I_{T(OC)(is)}$		0.616		mA/A
	Current sense input offset current	$V_{INL} = 5\text{V}$, $0\text{V} \leq V_{CS} \leq 2\text{V}$, $0\text{A} \leq I_{D(is)} < I_{T(OC)(is)}$	-82		82	mA
	Initial held output after overcurrent fault occurs while INL remains high	$V_{INL} = 5\text{V}$, $0\text{V} \leq V_{CS} \leq 2\text{V}$			7	mA
$I_{CS(src)}$ (OC)(final)	Final held output after overcurrent fault occurs while INL remains high	$V_{INL} = 5\text{V}$, $0\text{V} \leq V_{CS} \leq 2\text{V}$	10	12	15.5	mA
	Output clamp voltage	$V_{INL} = 5\text{V}$, $I_{D(is)} = 8.1\text{A}$, CS sinking 5mA from external source		2.5		V
EN, INL, INH						
V_{IT+}	Positive-going input threshold voltage		1.7		2.45	V
V_{IT-}	Negative-going input threshold voltage		0.7		1.3	V
	Input threshold voltage hysteresis			1		V
	Pull-down input resistance	$0\text{V} \leq V_{PIN} \leq 3\text{V}$	200	400	600	k Ω
	Pull-down input current	$10\text{V} \leq V_{PIN} \leq 26\text{V}$; $V_{AUX} = 26\text{V}$		10		μA
OVER-TEMPERATURE PROTECTION						
	Temperature fault – positive-going threshold temperature			150		$^{\circ}\text{C}$
	Temperature fault – negative-going threshold temperature			130		$^{\circ}\text{C}$
	Temperature fault – threshold temperature hysteresis			20		$^{\circ}\text{C}$
FLT						
	Low-level output voltage	FLT sinking 1mA while asserted			200	mV
	Off-state sink current	$V_{FLT} = V_{AUX}$ while de-asserted			1	μA
AUX						
$V_{AUX,T+}$ (UVLO)	UVLO – positive-going threshold voltage		8.9	9.3	9.7	V
	UVLO – negative-going threshold voltage		8.6	9.0	9.4	V
	UVLO – threshold voltage hysteresis			250		mV
	Standby quiescent current	$V_{EN} = 0\text{V}$		50	80	μA
	Quiescent current			250	370	μA
		$V_{INL} = 5\text{V}$, $I_{D(is)} = 0\text{A}$		1250		μA
	Operating current	$V_{INL} = 0\text{V}$ or 5V , $V_{DS(is)} = 0\text{V}$, $I_{D(is)} = 0\text{A}$, $f_{INL} = 500\text{kHz}$		3.5		mA
BST						
$V_{BST_SW,T+}$ (UVLO)	V_{BST_SW} UVLO for FET to turn on – positive-going threshold voltage		6.7	7	7.3	V
	V_{BST_SW} UVLO for FET to stay on – negative-going threshold voltage		4.8	5.1	5.4	V
	Quiescent current			65	100	μA
		$V_{INH} = 5\text{V}$		350		

5.5 Electrical Characteristics (continued)

1) Symbol definitions: $V_{DS(is)}$ = SW to SL voltage; $I_{DS(is)}$ = SW to SL current; $V_{DS(hs)}$ = DH to SW voltage; $I_{D(hs)}$ = DH to SW current; 2) Unless otherwise noted: voltage, resistance, and capacitance are respect to AGND; $-40^{\circ}\text{C} \leq T_J \leq 125^{\circ}\text{C}$; $10\text{V} \leq V_{AUX} \leq 26\text{V}$; $7.5\text{V} \leq V_{BST_SW} \leq 26\text{V}$; $V_{EN} = 5\text{V}$; $V_{INL} = 0\text{V}$; $V_{INH} = 0\text{V}$; $R_{CS} = 100\Omega$

PARAMETER		TEST CONDITIONS	MIN	TYP	MAX	UNIT
	Operating current	$V_{INH} = 0\text{V}$ or 5V , $V_{DS(hs)} = 0\text{V}$; $f_{INH} = 500\text{kHz}$		2.1		mA

5.6 Switching Characteristics

1) Symbol definitions: $V_{DS(is)}$ = SW to SL voltage; $I_{D(is)}$ = SW to SL current; $V_{DS(hs)}$ = DH to SW voltage; $I_{D(hs)}$ = DH to SW current; 2) Unless otherwise noted: voltage, resistance, and capacitance are respect to AGND; $-40^{\circ}\text{C} \leq T_J \leq 125^{\circ}\text{C}$; $10\text{V} \leq V_{AUX} \leq 26\text{V}$; $7.5\text{V} \leq V_{BST_SW} \leq 26\text{V}$; $V_{EN} = 5\text{V}$; $V_{INL} = 0\text{V}$; $V_{INH} = 0\text{V}$; $R_{CS} = 100\Omega$

PARAMETER		TEST CONDITIONS	MIN	TYP	MAX	UNIT
LOW-SIDE GAN POWER FET						
$t_{d(on)}$ (I_{drain})(I_s)	Drain current turn-on delay time	From $V_{INL} > V_{INL,IT+}$ to $I_{D(is)} > 50\text{mA}$, $V_{BUS} = 400\text{V}$, L_{HB} current = 2.5A		33		ns
$t_{d(on)}$ (I_s)	Turn-on delay time	From $V_{INL} > V_{INL,IT+}$ to $V_{DS(is)} < 320\text{V}$, $V_{BUS} = 400\text{V}$, L_{HB} current = 2.5A		39		ns
$t_{r(on)}$ (I_s)	Turn-on rise time	From $V_{DS(is)} < 320\text{V}$ to $V_{DS(is)} < 80\text{V}$, $V_{BUS} = 400\text{V}$, L_{HB} current = 2.5A		2.4		ns
$t_{d(off)}$ (I_s)	Turn-off delay time	From $V_{INL} < V_{INL,IT-}$ to $V_{DS(is)} > 80\text{V}$, $V_{BUS} = 400\text{V}$, L_{HB} current = 2.5A		40		ns
$t_{f(off)}$ (I_s)	Turn-off fall time	From $V_{DS(is)} > 80\text{V}$ to $V_{DS(is)} > 320\text{V}$, $V_{BUS} = 400\text{V}$, L_{HB} current = 2.5A		16.0		ns
	Turn-on slew rate	From $V_{DS(is)} < 250\text{V}$ to $V_{DS(is)} < 150\text{V}$, $T_J = 25^{\circ}\text{C}$, $V_{BUS} = 400\text{V}$, L_{HB} current = 2.5A		125		V/ns

5.6 Switching Characteristics (continued)

1) Symbol definitions: $V_{DS(is)}$ = SW to SL voltage; $I_{DS(is)}$ = SW to SL current; $V_{DS(hs)}$ = DH to SW voltage; $I_{D(hs)}$ = DH to SW current; 2) Unless otherwise noted: voltage, resistance, and capacitance are respect to AGND; $-40^{\circ}\text{C} \leq T_J \leq 125^{\circ}\text{C}$; $10\text{V} \leq V_{AUX} \leq 26\text{V}$; $7.5\text{V} \leq V_{BST_SW} \leq 26\text{V}$; $V_{EN} = 5\text{V}$; $V_{INL} = 0\text{V}$; $V_{INH} = 0\text{V}$; $R_{CS} = 100\Omega$

PARAMETER		TEST CONDITIONS	MIN	TYP	MAX	UNIT
HIGH-SIDE GAN POWER FET						
$t_{d(on)}$ (I_{drain})(hs)	Drain current turn-on delay time	From $V_{INH} > V_{INH,IT+}$ to $I_{D(hs)} > 50\text{mA}$, $V_{BUS} = 400\text{V}$, L_{HB} current = 2.5A		33		ns
$t_{d(on)}$ (hs)	Turn-on delay time	From $V_{INH} > V_{INH,IT+}$ to $V_{DS(hs)} < 320\text{V}$, $V_{BUS} = 400\text{V}$, L_{HB} current = 2.5A		39		ns
$t_{r(on)}$ (hs)	Turn-on rise time	From $V_{DS(hs)} < 320\text{V}$ to $V_{DS(hs)} < 80\text{V}$, $V_{BUS} = 400\text{V}$, L_{HB} current = 2.5A		2.4		ns
$t_{d(off)}$ (hs)	Turn-off delay time	From $V_{INH} < V_{INH,IT-}$ to $V_{DS(hs)} > 80\text{V}$, $V_{BUS} = 400\text{V}$, L_{HB} current = 2.5A		40		ns
$t_{f(off)}$ (hs)	Turn-off fall time	From $V_{DS(hs)} > 80\text{V}$ to $V_{DS(hs)} > 320\text{V}$, $V_{BUS} = 400\text{V}$, L_{HB} current = 2.5A		16.0		ns
	Turn-on slew rate	From $V_{DS(hs)} < 250\text{V}$ to $V_{DS(hs)} < 150\text{V}$, T_J = 25°C , $V_{BUS} = 400\text{V}$, L_{HB} current = 2.5A		125		V/ns

5.6 Switching Characteristics (continued)

1) Symbol definitions: $V_{DS(ls)}$ = SW to SL voltage; $I_{D(ls)}$ = SW to SL current; $V_{DS(hs)}$ = DH to SW voltage; $I_{D(hs)}$ = DH to SW current; 2) Unless otherwise noted: voltage, resistance, and capacitance are respect to AGND; $-40^{\circ}\text{C} \leq T_J \leq 125^{\circ}\text{C}$; $10\text{V} \leq V_{AUX} \leq 26\text{V}$; $7.5\text{V} \leq V_{BST_SW} \leq 26\text{V}$; $V_{EN} = 5\text{V}$; $V_{INL} = 0\text{V}$; $V_{INH} = 0\text{V}$; $R_{CS} = 100\Omega$

PARAMETER	TEST CONDITIONS	MIN	TYP	MAX	UNIT
LOW-SIDE OVERCURRENT PROTECTION					
$t_{(OC)(ls)}$	Overcurrent fault response time, FET on before overcurrent	From $I_{D(ls)} > I_{T(OC)(ls)}$ to $I_{D(ls)} < 0.5 \times I_{T(OC)(ls)}$, at following $I_{D(ls)}$ slew rate			
		$I_{D(ls)}$ di/dt = 12 A/ μs		175	ns
		$I_{D(ls)}$ di/dt = 24 A/ μs		150	ns
		$I_{D(ls)}$ di/dt = 120 A/ μs		90	
$t_{(OC)(en)(ls)}$	Overcurrent fault response time, FET enabled into a short	$V_{DS(ls)} = 50\text{V}$; From $I_{D(ls)} > I_{T(OC)(ls)}$ to $I_{D(ls)} < 0.5 \times I_{T(OC)(ls)}$		122	ns
HIGH-SIDE OVERCURRENT PROTECTION					
$t_{(OC)(hs)}$	Overcurrent fault response time, FET on before overcurrent	From $I_{D(hs)} > I_{T(OC)(hs)}$ to $I_{D(hs)} < 0.5 \times I_{T(OC)(hs)}$, at following $I_{D(hs)}$ slew rate			
		$I_{D(hs)}$ di/dt = 12 A/ μs		175	ns
		$I_{D(hs)}$ di/dt = 24 A/ μs		150	ns
		$I_{D(hs)}$ di/dt = 120 A/ μs		90	
$t_{(OC)(en)(hs)}$	Overcurrent fault response time, FET enabled into a short	$V_{DS(hs)} = 50\text{V}$; From $I_{D(hs)} > I_{T(OC)(hs)}$ to $I_{D(hs)} < 0.5 \times I_{T(OC)(hs)}$		122	ns

5.6 Switching Characteristics (continued)

1) Symbol definitions: $V_{DS(is)}$ = SW to SL voltage; $I_{D(is)}$ = SW to SL current; $V_{DS(hs)}$ = DH to SW voltage; $I_{D(hs)}$ = DH to SW current; 2) Unless otherwise noted: voltage, resistance, and capacitance are respect to AGND; $-40^{\circ}\text{C} \leq T_J \leq 125^{\circ}\text{C}$; $10\text{V} \leq V_{AUX} \leq 26\text{V}$; $7.5\text{V} \leq V_{BST_SW} \leq 26\text{V}$; $V_{EN} = 5\text{V}$; $V_{INL} = 0\text{V}$; $V_{INH} = 0\text{V}$; $R_{CS} = 100\Omega$

PARAMETER		TEST CONDITIONS	MIN	TYP	MAX	UNIT
CS						
t_r	Rise time	From $I_{CS(src)} > 0.1 \times I_{CS(src)(final)}$ to $I_{CS(src)} > 0.9 \times I_{CS(src)(final)}$, $0\text{V} \leq V_{CS} \leq 2\text{V}$, Low-side enabled into a 2.5A load			35	ns
EN						
	EN wake-up time	From $V_{EN} > V_{IT+}$ to $I_{D(is)} > 10\text{mA}$, $V_{INL} = 5\text{V}$		1.5		μs
BST						
	Start-up time from deep BST to SW discharge	From $V_{BST_SW} > V_{BST_SW,T+(UVLO)}$ to high-side reacts to INH rising edge with V_{BST_SW} rising from 0V to 10V in 1 μs		5		μs
	Start-up time from shallow BST to SW discharge	From $V_{BST_SW} > V_{BST_SW,T+(UVLO)}$ to high-side reacts to INH rising edge with V_{BST_SW} rising from 5V to 10V in 0.5 μs		2		μs

5.7 Typical Characteristics

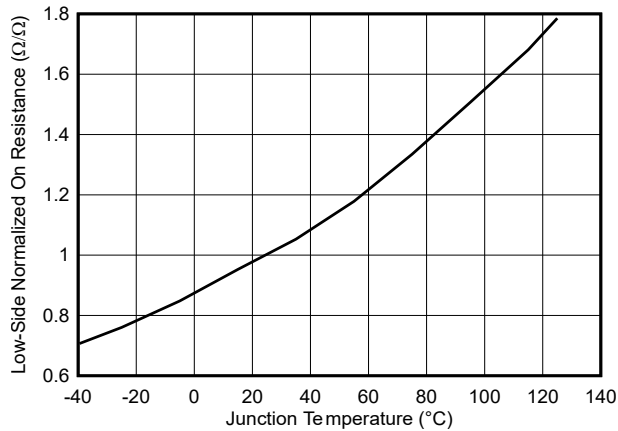

Figure 5-1. Low-Side Normalized On-Resistance vs Junction Temperature

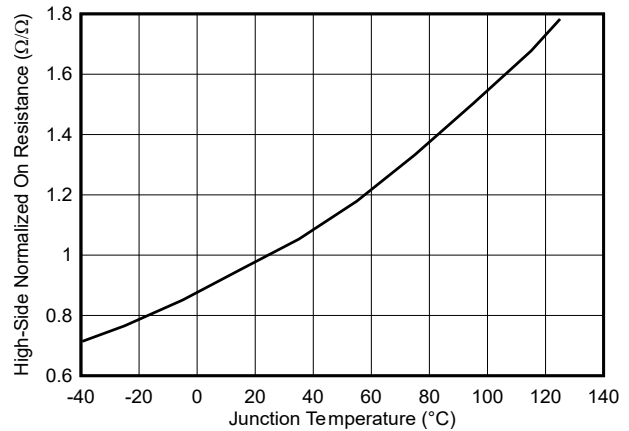

Figure 5-2. High-Side Normalized On-Resistance vs Junction Temperature

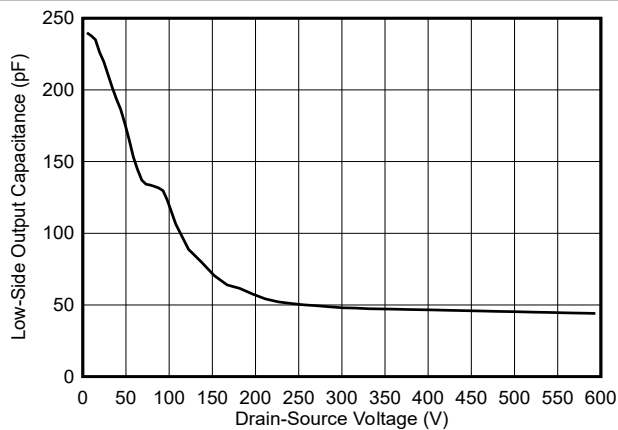

Figure 5-3. Low-Side Output Capacitance vs Drain-Source Voltage

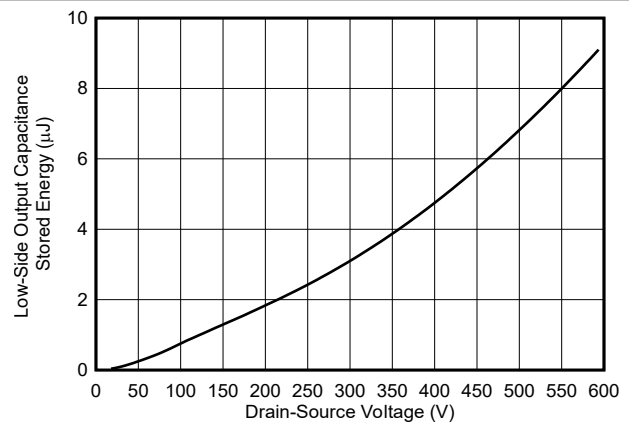

Figure 5-4. Low-Side Output Capacitance Stored Energy vs Drain-Source Voltage

5.7 Typical Characteristics (continued)

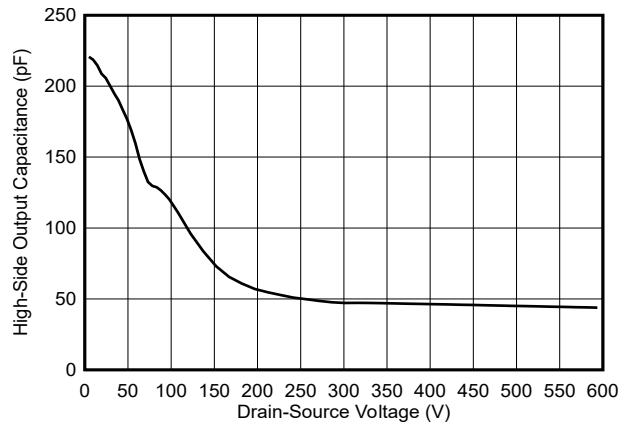

Figure 5-5. High-Side Output Capacitance vs Drain-Source Voltage

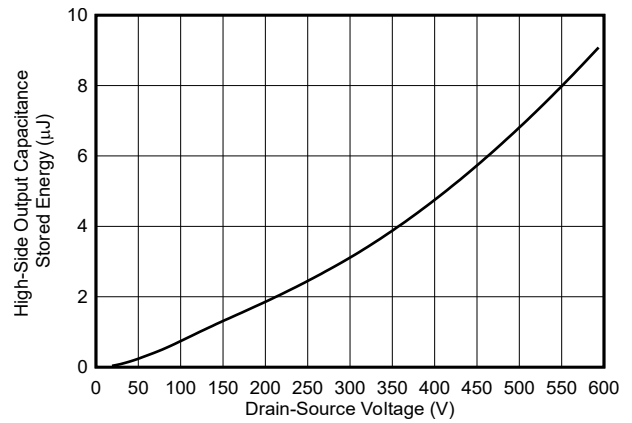

Figure 5-6. High-Side Output Capacitance Stored Energy vs Drain-Source Voltage

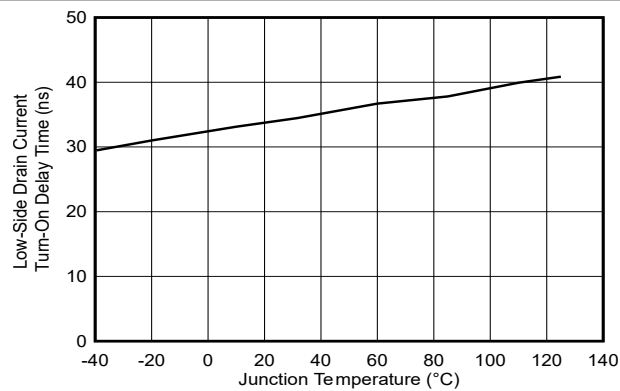

Figure 5-7. Low-Side Drain Current Turn-On Delay Time vs Junction Temperature

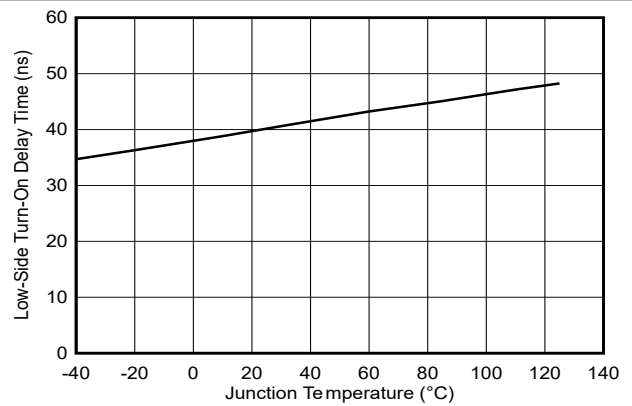

Figure 5-8. Low-Side Turn-On Delay Time vs Junction Temperature

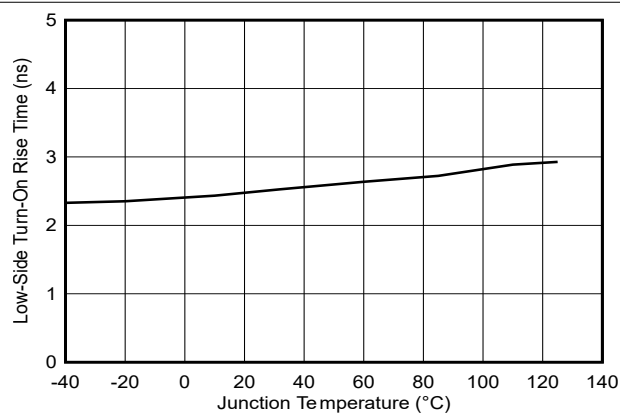

Figure 5-9. Low-Side Turn-On Rise Time vs Junction Temperature

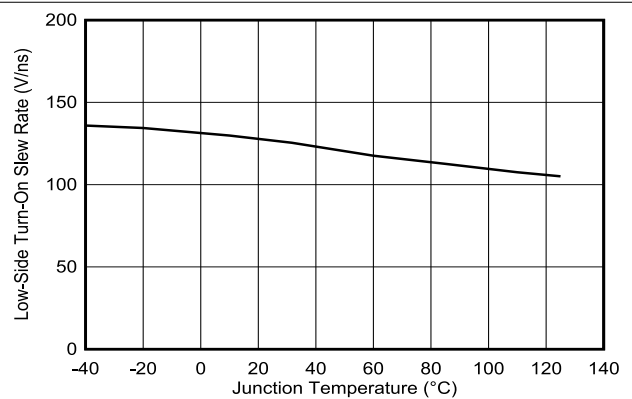

Figure 5-10. Low-Side Turn-On Slew Rate vs Junction Temperature

5.7 Typical Characteristics (continued)

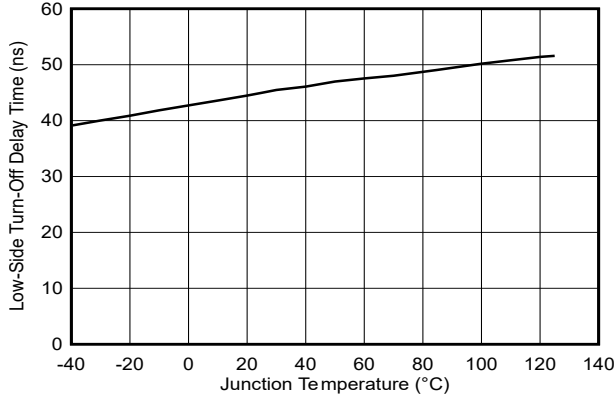

Figure 5-11. Low-Side Turn-Off Delay Time vs Junction Temperature

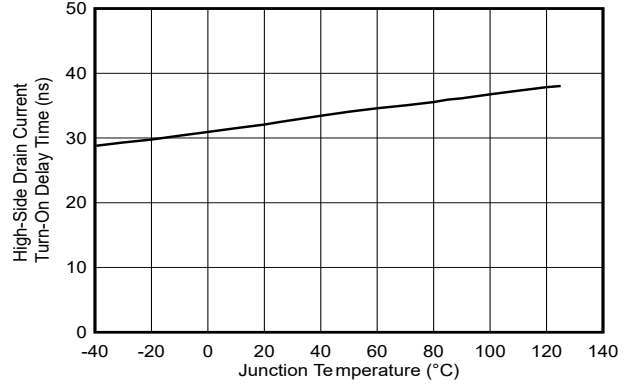

Figure 5-12. High-Side Drain Current Turn-On Delay Time vs Junction Temperature

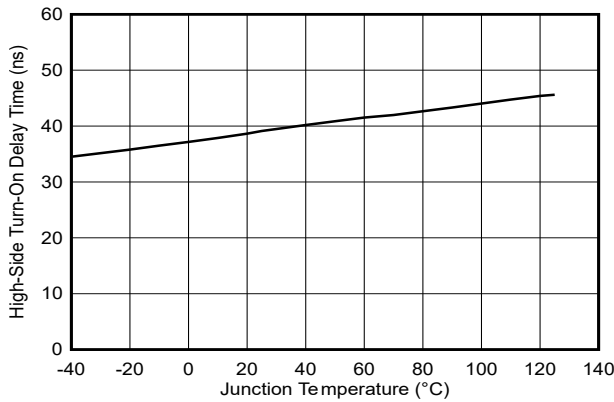

Figure 5-13. High-Side Turn-On Delay Time vs Junction Temperature

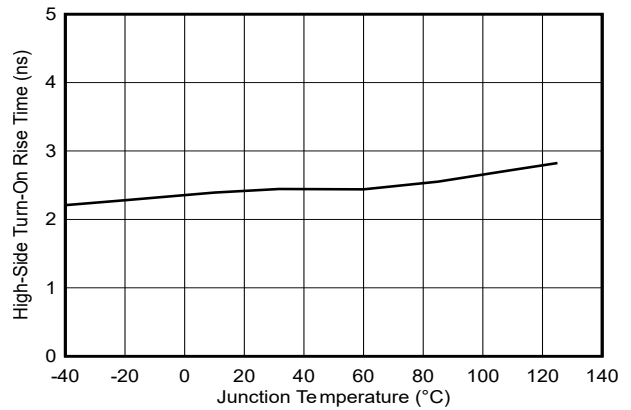

Figure 5-14. High-Side Turn-On Rise Time vs Junction Temperature

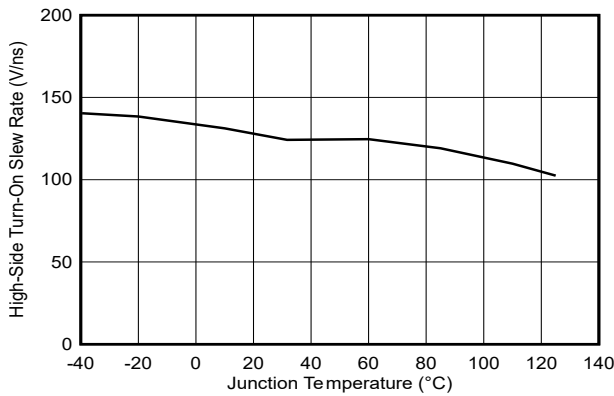

Figure 5-15. High-Side Turn-On Slew Rate vs Junction Temperature

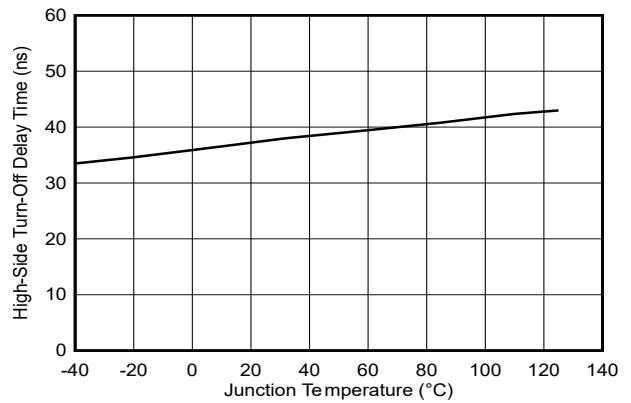

Figure 5-16. High-Side Turn-Off Delay Time vs Junction Temperature

5.7 Typical Characteristics (continued)

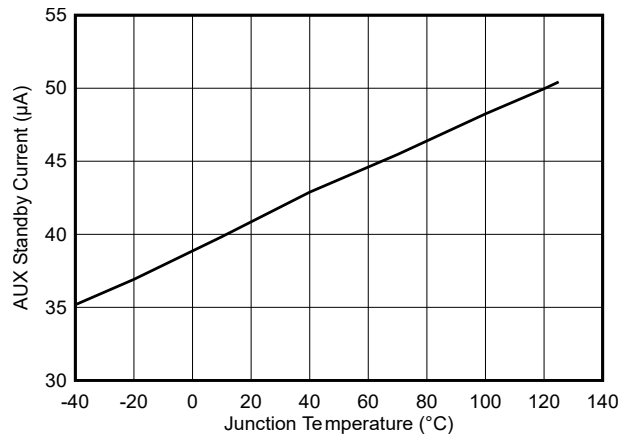

Figure 5-17. AUX Standby Current vs Junction Temperature

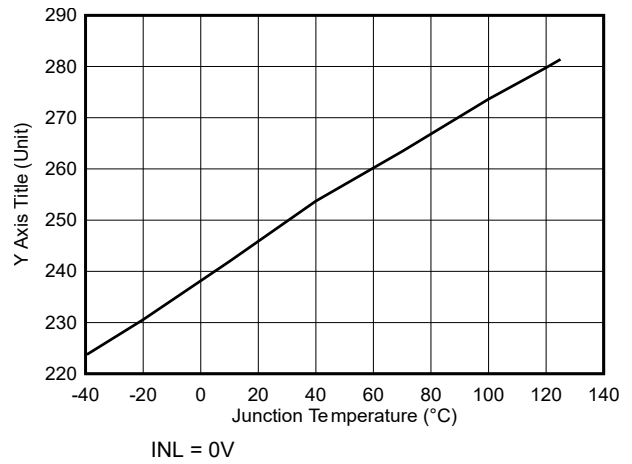

Figure 5-18. AUX Quiescent Current vs Junction Temperature

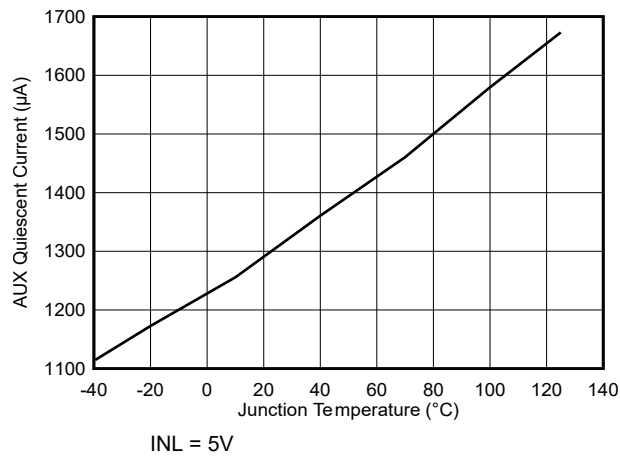

Figure 5-19. AUX Quiescent Current vs Junction Temperature

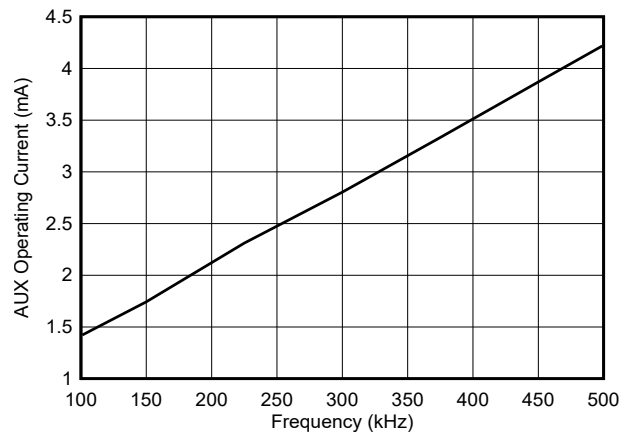

Figure 5-20. AUX Operating Current vs Frequency

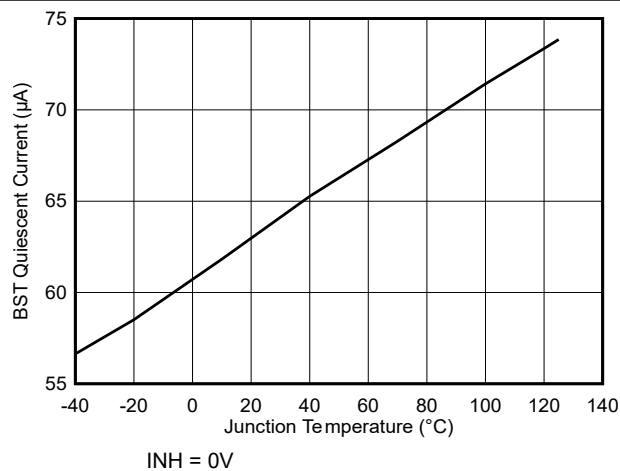

Figure 5-21. BST Quiescent Current vs Junction Temperature

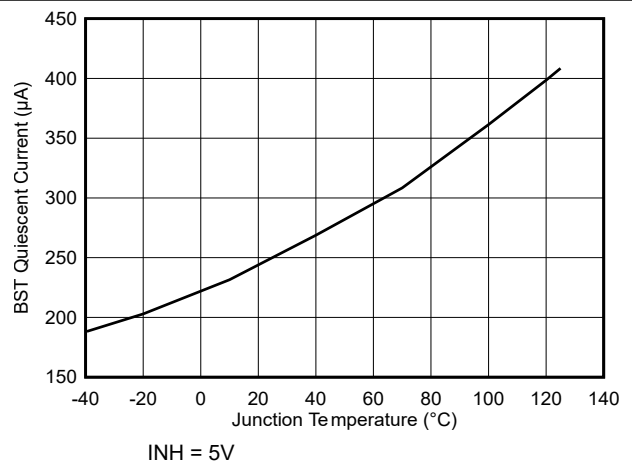

Figure 5-22. BST Quiescent Current vs Junction Temperature

5.7 Typical Characteristics (continued)

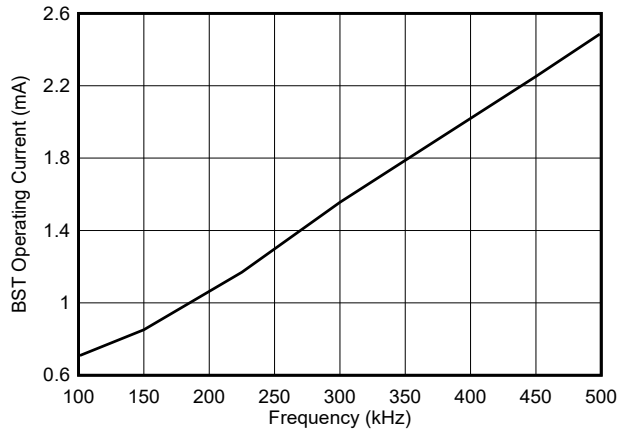

Figure 5-23. BST Operating Current vs Frequency

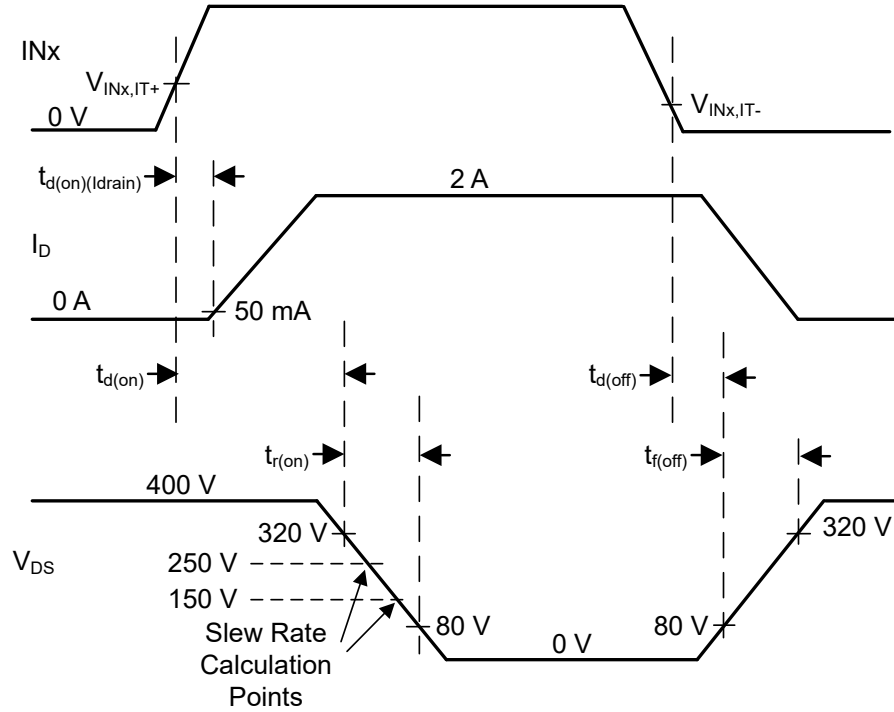

Figure 6-2. GaN Power FET Switching Parameters

7 Detailed Description

7.1 Overview

The LMG2640 is a highly-integrated 650V GaN power-FET half bridge. The LMG2640 combines the half-bridge power FETs, gate drivers, low-side current-sense emulation function, high-side gate-drive level shifter, and bootstrap diode function in a 9mm by 7mm QFN package.

The GaN half-bridge consists of 105mΩ low-side FET and high-side FETs.

The LMG2640 internal gate drivers regulate the drive voltage for optimum GaN power-FET on-resistance. Internal drivers also reduce total gate inductance and GaN FET common-source inductance for improved switching performance, including common-mode transient immunity (CMTI).

Current-sense emulation places a scaled replica of the low-side drain current on the output of the CS pin. The CS pin is terminated with a resistor to AGND to create the current-sense input signal to the external power supply controller. This CS pin resistor replaces the traditional current-sense resistor, placed in series with the low-side GaN FET source, at significant power and space savings. Furthermore, with no current-sense resistor in series with the GaN source, the low-side GaN FET thermal pad can be connected directly to the PCB power ground. This thermal pad connection both improves system thermal performance and provides additional device routing flexibility since full device current can be conducted through the thermal pads.

The high-side gate-drive level-shifter reduces the capacitive coupling of the sensitive high-side gate drive path for lower noise susceptibility and better CMTI compared to external solutions where the signal path has a much larger PCB footprint. The level shifter also has minimal impact on device quiescent current and no impact on device start-up time compared to external solutions with worse quiescent current and start up performance.

The bootstrap diode function between AUX and BST is implemented with a smart-switched GaN bootstrap FET. The switched GaN bootstrap FET allows more complete charging of the BST-to-SW capacitor since the on-state GaN bootstrap FET does not have the forward voltage drop of a traditional bootstrap diode. The smart-switched GaN bootstrap FET also avoids the traditional bootstrap diode problem of BST-to-SW capacitor overcharging due to off-state third-quadrant current flow in the low-side half-bridge GaN power FET. Finally, the bootstrap function has more efficient switching due to low capacitance and no reverse-recovery charge compared to the traditional bootstrap diode.

The AUX input supply wide voltage range is compatible with the corresponding wide range supply rail created by power supply controllers. The BST input supply range is even wider on the low end to account for capacitive droop in between bootstrap recharge cycles. Low AUX / BST idle quiescent currents and fast BST start-up time support converter burst-mode operation critical for meeting government light-load efficiency mandates. Further AUX quiescent current reduction is obtained by placing the device in standby mode with the EN pin.

The INL, INH, and EN control pins have high input impedance, low input threshold voltage and maximum input voltage equal to the AUX voltage. This allows the pins to support both low voltage and high voltage input signals and be driven with low-power outputs.

The LMG2640 protection features are low-side / high-side under-voltage lockout (UVLO), low-side / high-side input gate-drive interlock, low-side / high-side cycle-by-cycle current limit, and over-temperature shut down. The UVLO features also help achieve well-behaved converter operation. The over-temperature shut down is reported on the open drain $\overline{\text{FLT}}$ output.

7.2 Functional Block Diagram

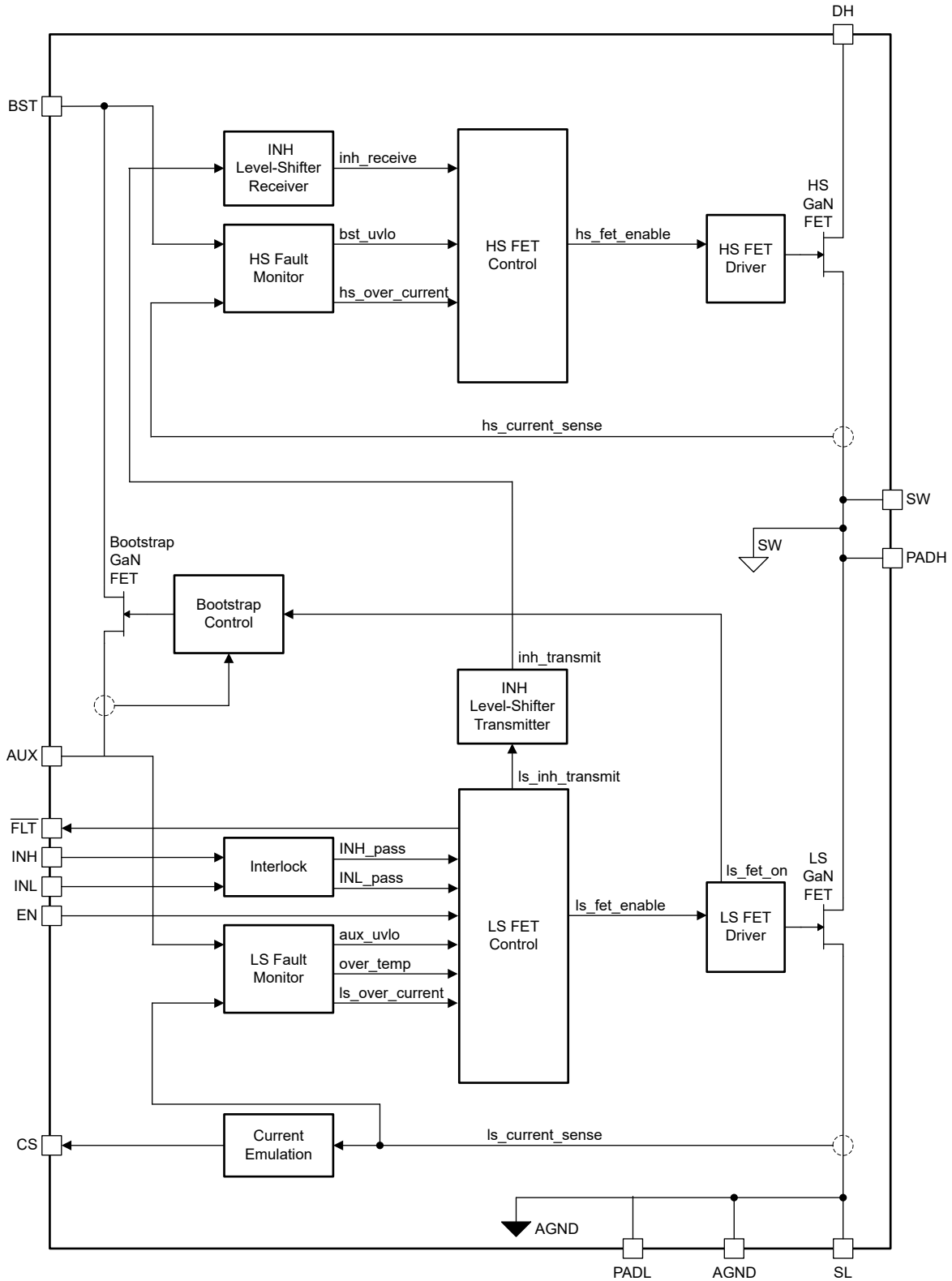

7.3 Feature Description

7.3.1 GaN Power FET Switching Capability

Due to the silicon FET's long reign as the dominant power-switch technology, many designers are unaware that the nameplate drain-source voltage cannot be used as an equivalent point to compare devices across technologies. The nameplate drain-source voltage of a silicon FET is set by the avalanche breakdown voltage. The nameplate drain-source voltage of a GaN FET is set by the long term compliance to data sheet specifications.

Exceeding the nameplate drain-source voltage of a silicon FET can lead to immediate and permanent damage. Meanwhile, the breakdown voltage of a GaN FET is much higher than the nameplate drain-source voltage. For example, the breakdown drain-source voltage of the LMG2640 GaN power FET is more than 800V which allows the LMG2640 to operate at conditions beyond an identically nameplate rated silicon FET.

The LMG2640 GaN power FET switching capability is explained with the assistance of [Figure 7-1](#). The figure shows the drain-source voltage versus time for the LMG2640 GaN power FET for four distinct switch cycles in a switching application. No claim is made about the switching frequency or duty cycle. The first two cycles show normal operation and the second two cycles show operation during a rare input voltage surge. The LMG2640 GaN power FETs are intended to be turned on in either zero-voltage switching (ZVS) or discontinuous-conduction mode (DCM) switching conditions.

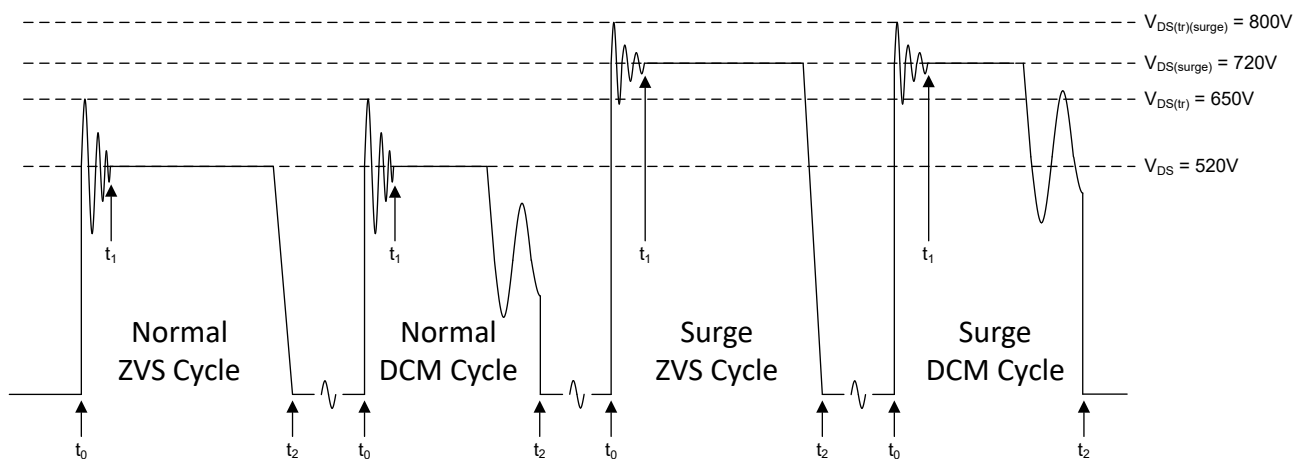

Figure 7-1. GaN Power FET Switching Capability

Each cycle starts before t_0 with the FET in the on state. At t_0 the GaN FET turns off and parasitic elements cause the drain-source voltage to ring at a high frequency. The high frequency ringing has damped out by t_1 . Between t_1 and t_2 the FET drain-source voltage is set by the characteristic response of the switching application. The characteristic is shown as a flat line (plateau), but other responses are possible. At t_2 the GaN FET is turned on. For normal operation, the transient ring voltage is limited to 650V and the plateau voltage is limited to 520V. For rare surge events, the transient ring voltage is limited to 800V and the plateau voltage is limited to 720V.

7.3.2 Current-Sense Emulation

The current-sense emulation function creates a scaled replica of the low-side GaN power FET positive drain current at the output of the CS pin. The current-sense emulation gain, G_{CSSE} , is 0.616mA output from the CS pin, I_{CS} for every 1A passing into the drain of the low-side GaN power FET, I_D .

$$G_{CSSE} = I_{CS} / I_D = 0.616\text{mA} / 1\text{A} = 0.000616 \quad (1)$$

The CS pin is terminated with a resistor to AGND, R_{CS} , to create the current-sense voltage input signal to the external power supply controller.

R_{CS} is determined by solving for the traditional current-sense design resistance, $R_{CS(\text{trad})}$, and multiplying by the inverse of G_{CSSE} . The traditional current-sense design creates the current-sense voltage, $V_{CS(\text{trad})}$, by passing the low-side GaN power FET drain current, I_D , through $R_{CS(\text{trad})}$. The LMG2640 creates the current-sense voltage, V_{CS} , by passing the CS pin output current, I_{CS} , through R_{CS} . The current-sense voltage must be the same for both designs.

$$V_{CS} = I_{CS} \times R_{CS} = V_{CS(\text{trad})} = I_D \times R_{CS(\text{trad})} \quad (2)$$

$$R_{CS} = I_D / I_{CS} \times R_{CS(\text{trad})} = 1 / G_{CSSE} \times R_{CS(\text{trad})} \quad (3)$$

$$R_{CS} = 1,623 \times R_{CS(\text{trad})} \quad (4)$$

The CS pin is clamped internally to a typical 2.5V. The clamp protects vulnerable power-supply controller current-sense input pins from over voltage if, for example, the current sense resistor on the CS pin were to become disconnected.

Figure 7-2 shows the current-sense emulation operation. In both cycles, the CS pin current emulates the low-side GaN power-FET drain current while the low-side FET is enabled. The first cycle shows normal operation where the controller turns off the low-side GaN power FET when the controller current-sense input threshold is tripped. The second cycle shows a fault situation where the LMG2640 *Overcurrent Protection* turns off the low-side GaN power FET before the controller current-sense input threshold is tripped. In this second cycle, the LMG2640 avoids a hung controller INL pulse by generating a fast-ramping artificial current-sense emulation signal to trip the controller current-sense input threshold. The artificial signal persists until the INL pin goes to logic-low which indicates the controller is back in control of switch operation.

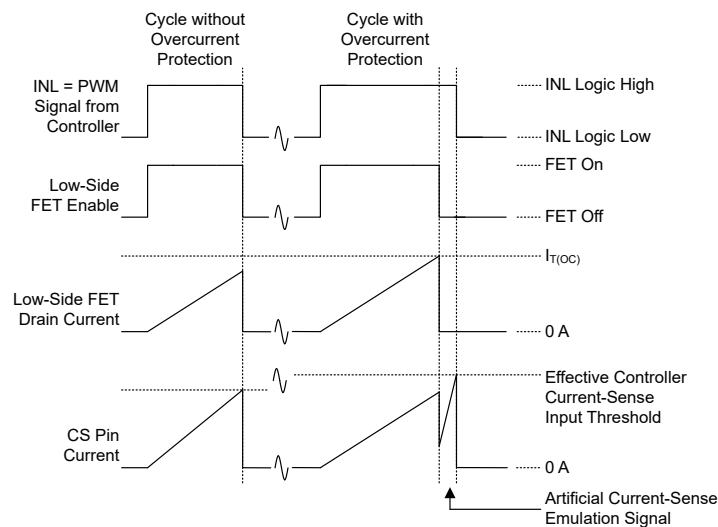

Figure 7-2. Current-Sense Emulation Operation

7.3.3 Bootstrap Diode Function

The internal bootstrap diode function is implemented with a smart-switched GaN bootstrap FET. The GaN bootstrap FET blocks current in both directions between AUX and BST when The GaN bootstrap FET is turned off.

The bootstrap diode function is active when the low-side GaN power FET is turned on and inactive when the low-side GaN power FET is turned off. The GaN bootstrap FET is held off in the bootstrap diode inactive phase. The GaN bootstrap FET is turned on a single time at the beginning of the bootstrap active phase and is controlled as an ideal diode with diode current flowing from AUX to BST to charge the BST-to-SW capacitor. If a small reverse current from BST to AUX is detected after the GaN bootstrap FET is turned on, the GaN bootstrap FET is turned off for the remainder of the bootstrap active phase.

The bootstrap diode function implements a current limit to protect the GaN bootstrap FET when the BST-to-SW capacitor is significantly discharged at the beginning of the bootstrap active phase. If there is no current limit situation during the GaN bootstrap FET turn on, or if the bootstrap function drops out of current limit as the BST-to-SW capacitor charges, the current limit function is disabled for the remainder of the GaN bootstrap FET turn-on time. The current limit function is disabled to save quiescent current.

7.3.4 Input Control Pins (EN, INL, INH)

The EN pin is used to toggle the device between the active and standby modes described in [Device Functional Modes](#).

The INL pin is used to turn the low-side GaN power FET on and off.

The INH pin is used to turn the high-side GaN power FET on and off.

The input control pins have a typical 1V input-voltage-threshold hysteresis for noise immunity. The pins also have a typical 400kΩ pull-down resistance to protect against floating inputs. The 400kΩ saturates for typical input voltages above 4V to limit the maximum input pull-down current to a typical 10uA.

The INL turn-on action is impacted by the following conditions 1) [Standby Mode](#), 2) [AUX UVLO](#), 3) INH in control of [Interlock](#), 4) Low-Side [Over-Current Protection](#), and 5) [Over-Temperature Protection](#).

The INH turn-on action is impacted by the following conditions 1) [Standby Mode](#), 2) [AUX UVLO](#), 3) INL in control of [Interlock](#), 4) High-Side [Over-Current Protection](#), and 5) [Over-Temperature Protection](#).

The [Standby Mode](#), [AUX UVLO](#), and [Over-Temperature Protection](#) are the universal INL / INH blocking conditions. These conditions hold both GaN half-bridge power FETs off independent of INL and INH. [Figure 7-3](#) shows the Universal Blocking Condition Operation. Note that the high-side FET does not turn on at transition #4. INH only turns on the high-side FET if there is no universal blocking condition when INH goes to logic high. This avoids an incomplete high-side FET turn-on period which can create undesired spike voltages in the converter.

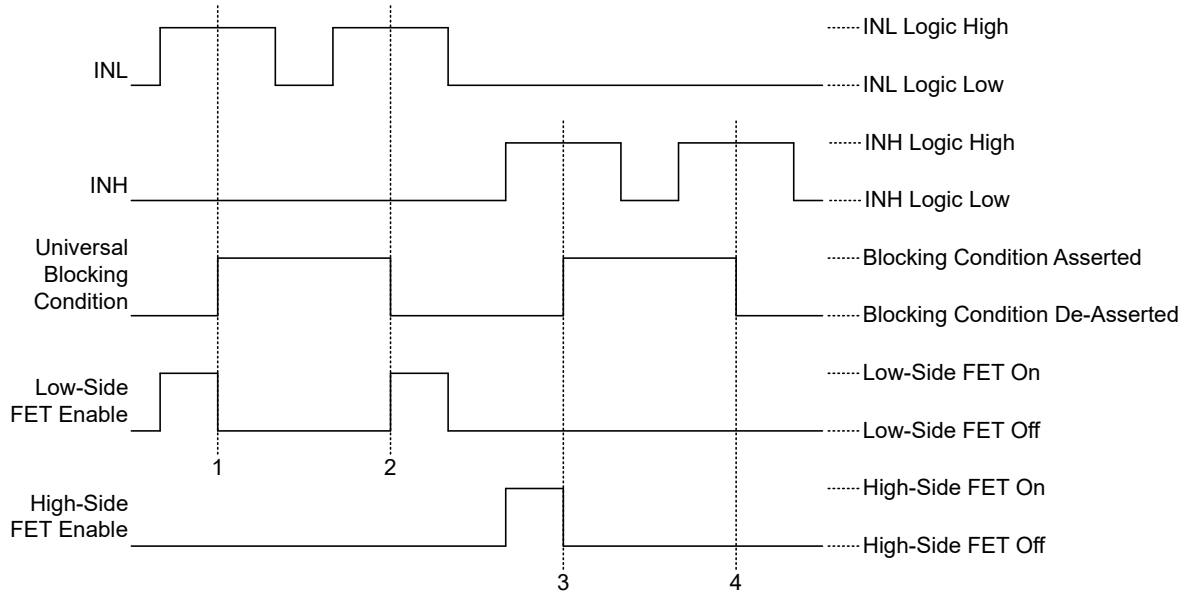

Figure 7-3. Universal INL / INH Blocking Condition Operation

7.3.5 INL - INH Interlock

The interlock function keeps the low-side and high-side GaN power FETs from being simultaneously turned on when the INL and INH pins are both logic-high. Either the INL or the INH pin gains control of the interlock if it is logic high when the other pin is logic low. Once the INL or INH pin gains control of the interlock, it retains control as long as it remains logic high. Only the INL or INH pin in control of the interlock passes a logic-high signal through the interlock.

The interlock is disabled if any of the universal INL / INH blocking conditions defined in [Input Control Pins](#) are asserted. When the interlock is disabled, the interlock outputs are held at logic low. If both INL and INH are logic-high when the interlock is enabled, the INL takes priority, gains control of the interlock, and passes the INL logic-high signal through the interlock.

7.3.6 AUX Supply Pin

The AUX pin is the input supply for the low-side internal circuits and is the power source to charge the BST-to-SW capacitor through the internal bootstrap diode function.

7.3.6.1 AUX Power-On Reset

The AUX Power-On Reset disables all low-side functionality if the AUX voltage is below the AUX Power-On Reset voltage. The AUX Power-On Reset voltage is not specified but is around 5V. The AUX Power-On Reset enables the over-temperature protection function if the AUX voltage is above the AUX Power-On Reset voltage.

7.3.6.2 AUX Under-Voltage Lockout (UVLO)

The AUX UVLO holds off both the low-side and high-side GaN power FETs if the AUX voltage is below the AUX UVLO voltage. The AUX UVLO voltage is set higher than the BST UVLO voltage so the high-side GaN power FET can be operated when the low-side GaN power FET is operating. The voltage separation between the AUX UVLO voltage and BST UVLO voltage accounts for operating conditions where the bootstrap charging of the BST-to-SW capacitor from the AUX supply is incomplete. The AUX UVLO voltage hysteresis prevents on-off chatter near the UVLO voltage trip point.

7.3.7 BST Supply Pin

The BST pin is the input supply for the high-side internal circuits. The BST pin and corresponding high-side circuits are referenced to the SW pin. The BST pin is powered by the low-side AUX Supply pin through the internal bootstrap diode function. The bootstrap function is inactive when the low-side GaN FET is off and the BST pin must rely on an external BST-to-SW capacitor for the BST power source.

Designing the BST-to-SW capacitance is a trade-off between high-side charge-up time and hold-up time. The BST-to-SW external capacitance is recommended to be a ceramic capacitor that is at least 10nF over operating conditions.

7.3.7.1 BST Power-On Reset

The BST Power-On Reset voltage is with respect to the SW pin. The BST Power-On Reset disables all high-side functionality if the BST-to-SW voltage is below the BST Power-On Reset voltage. The BST Power-On Reset voltage is not specified but is around 5V.

7.3.7.2 BST Under-Voltage Lockout (UVLO)

The BST UVLO voltage is with respect to the SW pin. The BST UVLO only controls the high-side GaN power FET. The BST UVLO does not control the low-side GaN power FET. The BST UVLO consists of two separate UVLO functions to create a two-level BST UVLO. The upper BST UVLO is called the BST Turn-On UVLO and only controls if the high-side GaN power FET is turned on. The lower BST UVLO is called the BST Turn-Off UVLO and only controls if the high-side GaN power FET is turned off after the high-side GaN power FET is turned on. The operation of the two-level UVLO is not the same as a single UVLO with wide hysteresis.

Figure 7-4 shows the BST UVLO operation. The BST Turn-On UVLO prevents the high-side GaN power FET from turning on at a INH logic-high rising edge if the BST-to-SW voltage is below the BST Turn-On UVLO voltage - INH pulses #1, #2, and #5. After the high-side GaN power FET is successfully turned-on, the BST Turn-On UVLO is ignored and the BST Turn-Off UVLO output is watched for the remainder of the INH logic-high pulse - INH pulses #3, #4, and #6. The BST Turn-Off UVLO turns off the high-side GaN power FET for the remainder of the INH logic-high pulse if the BST-to-SW voltage falls below the BST Turn-Off UVLO voltage - INH pulse #6.

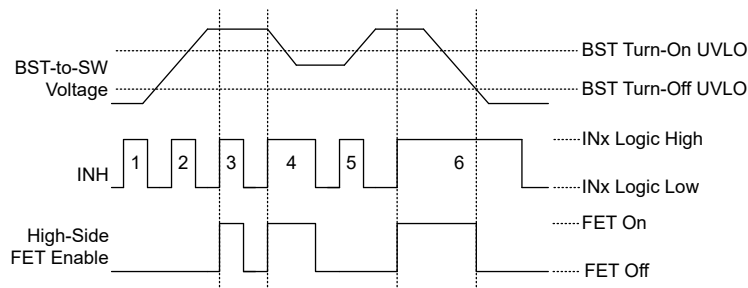

Figure 7-4. BST UVLO Operation

The effective voltage hysteresis of the two-level BST UVLO is the difference between the upper and lower BST UVLO voltages. A single-level BST UVLO can be implemented with the same hysteresis but allows subsequent high-side GaN power FET turn on anywhere in the hysteresis range. The two-level UVLO design prevents any turn on in the hysteresis range. A single-level BST UVLO would allow INH pulse #5 to turn on the high-side GaN power FET.

The two-level BST UVLO allows a wide hysteresis while making sure the BST-to-SW capacitor is adequately charged at the beginning of every INH pulse. The wide hysteresis allows a smaller BST-to-SW capacitor to be used which is useful for faster high-side start-up time. The adequate capacitor charge at the beginning of the INH pulse helps make sure the high-side GaN power FET is not turned-off early in the INH pulse which can create undesired spike voltages in the converter.

7.3.8 Over-Current Protection

The LMG2640 implements cycle-by-cycle over-current protection for both half-bridge GaN power FETs. [Figure 7-5](#) shows the cycle-by-cycle over-current operation. Every INx logic-high cycle turns on the GaN power FET. If the GaN power FET drain current exceeds the over-current threshold current, the over-current protection turns off the GaN power FET for the remainder of the INx logic-high duration.

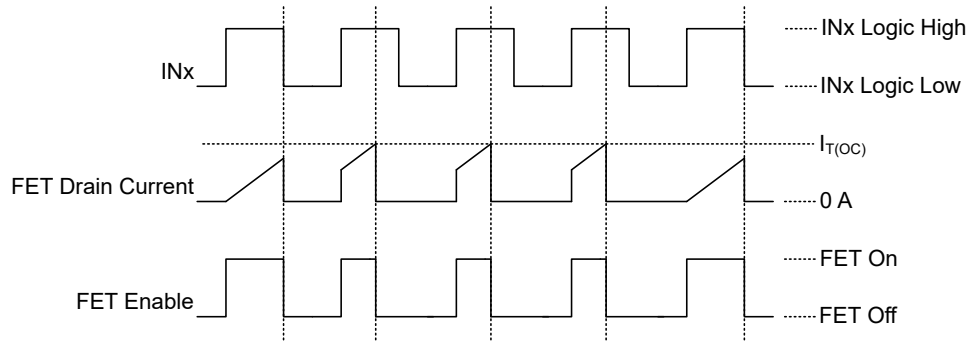

Figure 7-5. Cycle-by-Cycle Over-Current Protection Operation

An over-current protection event is not reported on the $\overline{\text{FLT}}$ pin. Cycle-by-cycle over-current protection minimizes system disruption because the event is not reported and because the protection allows the GaN power FET to turn on every INx cycle.

The low-side / high-side over-current protection threshold currents are set to different levels corresponding to the different GaN power FET sizes. As described in [Current-Sense Emulation](#), an artificial CS pin current is produced after the low-side GaN power FET is turned off by the low-side over-current protection, to prevent the controller from entering a hung state.

7.3.9 Over-Temperature Protection

The over-temperature protection holds off both the low-side and high-side GaN power FETs if the LMG2640 temperature is above the over-temperature shut-down temperature. The over-temperature shut-down hysteresis avoids erratic thermal cycling. An over-temperature fault is reported on the $\overline{\text{FLT}}$ pin when the over-temperature protection is asserted. This is the only fault event reported on the $\overline{\text{FLT}}$ pin. The over-temperature protection is enabled when the AUX voltage is above the [AUX Power-On Reset](#) voltage. The low AUX Power-On Reset voltage helps the over-temperature protection remain operational when the AUX rail droops during the cool-down phase.

7.3.10 Fault Reporting

The LMG2640 only reports an over-temperature fault. An over-temperature fault is reported on the $\overline{\text{FLT}}$ pin when the [Over-Temperature Protection](#) function is asserted. The $\overline{\text{FLT}}$ pin is an active low open-drain output so the pin pulls low when there is an over-temperature fault.

7.4 Device Functional Modes

The LMG2640 has two modes of operation controlled by the EN pin. The device is in Active mode when the EN is logic high and in Standby mode when the EN pin is logic low. In active mode, the half-bridge GaN power FETs are controlled by the INL and INH pins. In Standby mode, the INL and INH pins are ignored, the half-bridge GaN power FETs are held off, and the AUX quiescent current is reduced to the AUX standby quiescent current.

8.2.1 Design Requirements

Table 8-1. Design Specification

SPECIFICATION	VALUE
Input DC voltage range	365 VDC to 410 VDC
Output DC voltage	12V
Output rated current	23.34A
Output voltage ripple at 390 VDC	120mVpp
Peak efficiency at 390 VDC	93%

8.2.2 Detailed Design Procedure

The typical application shows the LMG2640 pairing a LLC controller to create a high-power-density, high-efficiency, 280W, LLC converter. The 280W LLC converter application is adapted from the typical application. This detailed design procedure focuses on the specifics of using the LMG2640 in the application.

8.2.3 Application Curve

The following waveform shows typical switching waveforms. The red trace is the switch-node voltage of LMG2640, the green trace is the current-sense voltage across C_{CS} , and the blue trace is V_{OUT} .

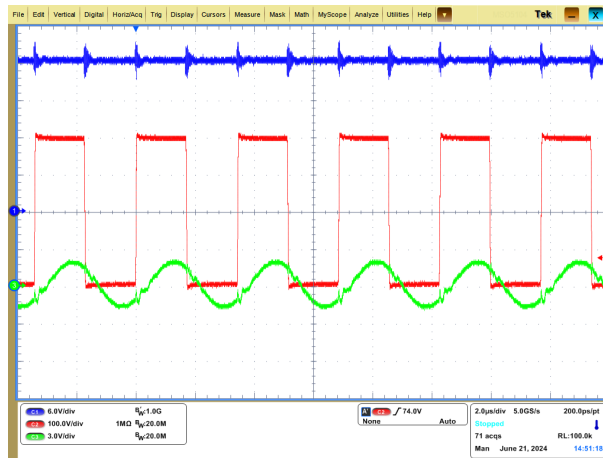

Figure 8-2. $V_{IN} = 400VDC$

8.3 Power Supply Recommendations

The LMG2640 operates from a single input supply connected to the AUX pin. The BST pin is powered internally by the AUX pin. The LMG2640 is intended to be operated from the same supply managed and used by the power supply controller. The wide recommended AUX voltage range of 10V to 26V overlaps common-controller supply-pin turn-on and UVLO voltage limits.

The BST-to-SW external capacitance is recommended to be a ceramic capacitor that is at least 10nF over operating conditions.

The AUX external capacitance is recommended to be a ceramic capacitor that is at least three-times larger than the BST-to-SW capacitance over operating conditions.

8.4 Layout

8.4.1 Layout Guidelines

8.4.1.1 Solder-Joint Stress Relief

Large QFN packages can experience high solder-joint stress. Several best practices are recommended to provide solder-joint stress relief. First, the instructions for the NC1, NC2, and NC3 anchor pins found in [Table 4-1](#) must be followed. Second, all the board solder pads must be non-solder-mask defined (NSMD) as shown in the land pattern example in the *Mechanical Data*. Finally, any board trace connected to an NSMD pad must be less than $2/3$ the width of the pad on the pad side where it is connected. The trace must maintain this $2/3$ width limit for as long as it is not covered by solder mask. After the trace is under solder mask, there are no limits on the trace dimensions. All these recommendations are followed in the [Layout Example](#).

8.4.1.2 Signal-Ground Connection

Design the power supply with separate signal and power grounds that only connect in one location. Connect the LMG2640 AGND pin to signal ground. Connect the LMG2640 SL pin and PADL thermal pad to power ground. The LMG2640 serves as the single connection point between the signal and power grounds since the AGND pin, SL pin, and PADL thermal pad are connected internally. Do not connect the signal and power grounds anywhere else on the board except as recommended in the next sentence. To facilitate board debug with the LMG2640 not installed, connect the AGND pad to the PADL thermal pad as shown in the [Layout Example](#).

8.4.1.3 CS Pin Signal

As seen with [Equation 4](#), the current-sense signal impedance is three orders of magnitude higher than a traditional current-sense signal. This higher impedance has implications for current-sense signal noise susceptibility. Minimize routing the current-sense signal near any noisy traces. Place the current-sense resistor and any filtering capacitors at the far end of the trace next to the controller current-sense input pin.

8.4.2 Layout Example

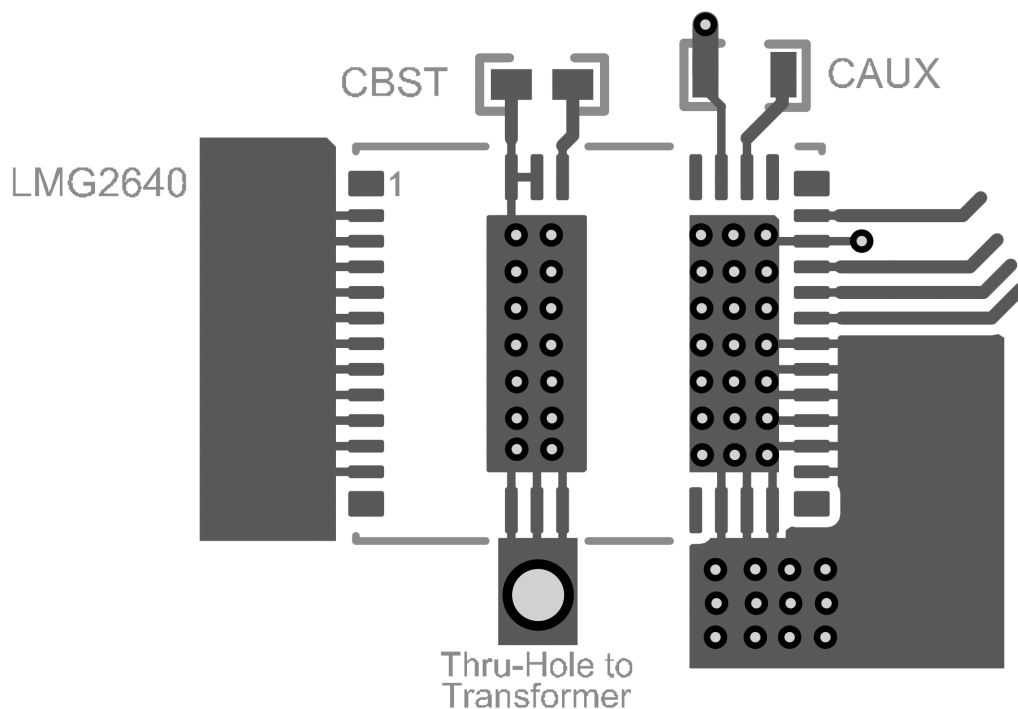

Figure 8-3. PCB Top Layer (First Layer)

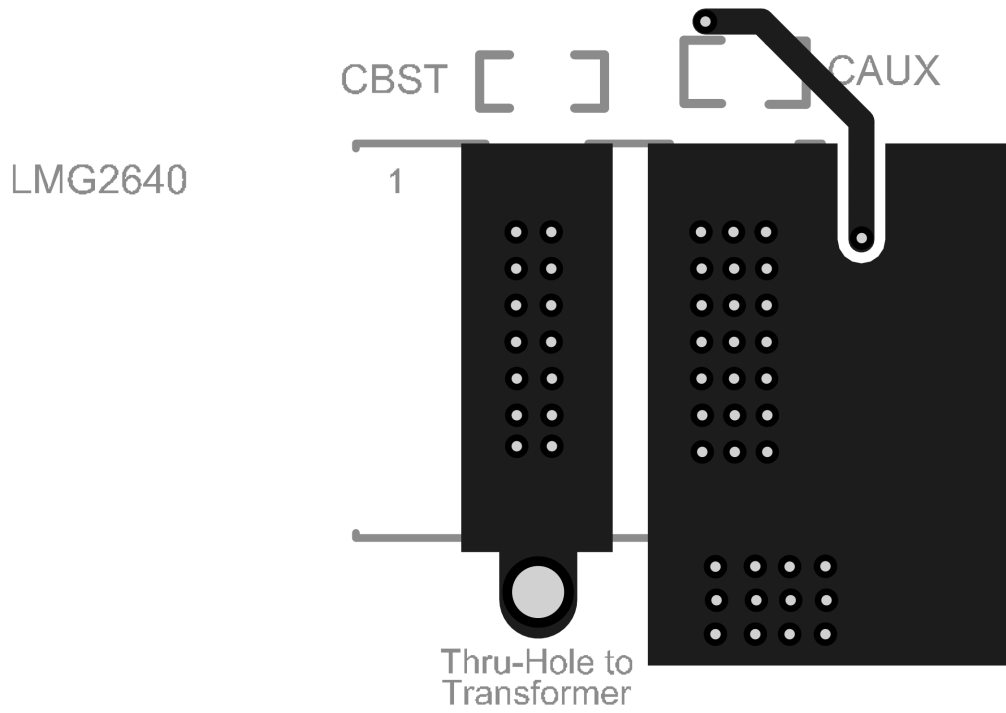

Figure 8-4. PCB Inner Layer (Second Layer)

9 Device and Documentation Support

TI offers an extensive line of development tools. Tools and software to evaluate the performance of the device, generate code, and develop solutions are listed below.

9.1 Documentation Support

9.1.1 Related Documentation

For related documentation see the following:

[LMG2640 Half-Bridge Daughter Card Evaluation Module](#)

9.2 Receiving Notification of Documentation Updates

To receive notification of documentation updates, navigate to the device product folder on [ti.com](#). Click on *Notifications* to register and receive a weekly digest of any product information that has changed. For change details, review the revision history included in any revised document.

9.3 Support Resources

[TI E2E™ support forums](#) are an engineer's go-to source for fast, verified answers and design help — straight from the experts. Search existing answers or ask your own question to get the quick design help you need.

Linked content is provided "AS IS" by the respective contributors. They do not constitute TI specifications and do not necessarily reflect TI's views; see TI's [Terms of Use](#).

9.4 Trademarks

TI E2E™ is a trademark of Texas Instruments.
All trademarks are the property of their respective owners.

9.5 Electrostatic Discharge Caution



This integrated circuit can be damaged by ESD. Texas Instruments recommends that all integrated circuits be handled with appropriate precautions. Failure to observe proper handling and installation procedures can cause damage.

ESD damage can range from subtle performance degradation to complete device failure. Precision integrated circuits may be more susceptible to damage because very small parametric changes could cause the device not to meet its published specifications.

9.6 Glossary

[TI Glossary](#) This glossary lists and explains terms, acronyms, and definitions.

10 Revision History

NOTE: Page numbers for previous revisions may differ from page numbers in the current version.

DATE	REVISION	NOTES
November 2024	*	Initial Release

11 Mechanical, Packaging, and Orderable Information

The following pages include mechanical, packaging, and orderable information. This information is the most current data available for the designated devices. This data is subject to change without notice and revision of this document. For browser-based versions of this data sheet, refer to the left-hand navigation.

RRG0040A-C01



PACKAGE OUTLINE
VQFN - 1.0 mm max height

PLASTIC QUAD FLATPACK - NO LEAD

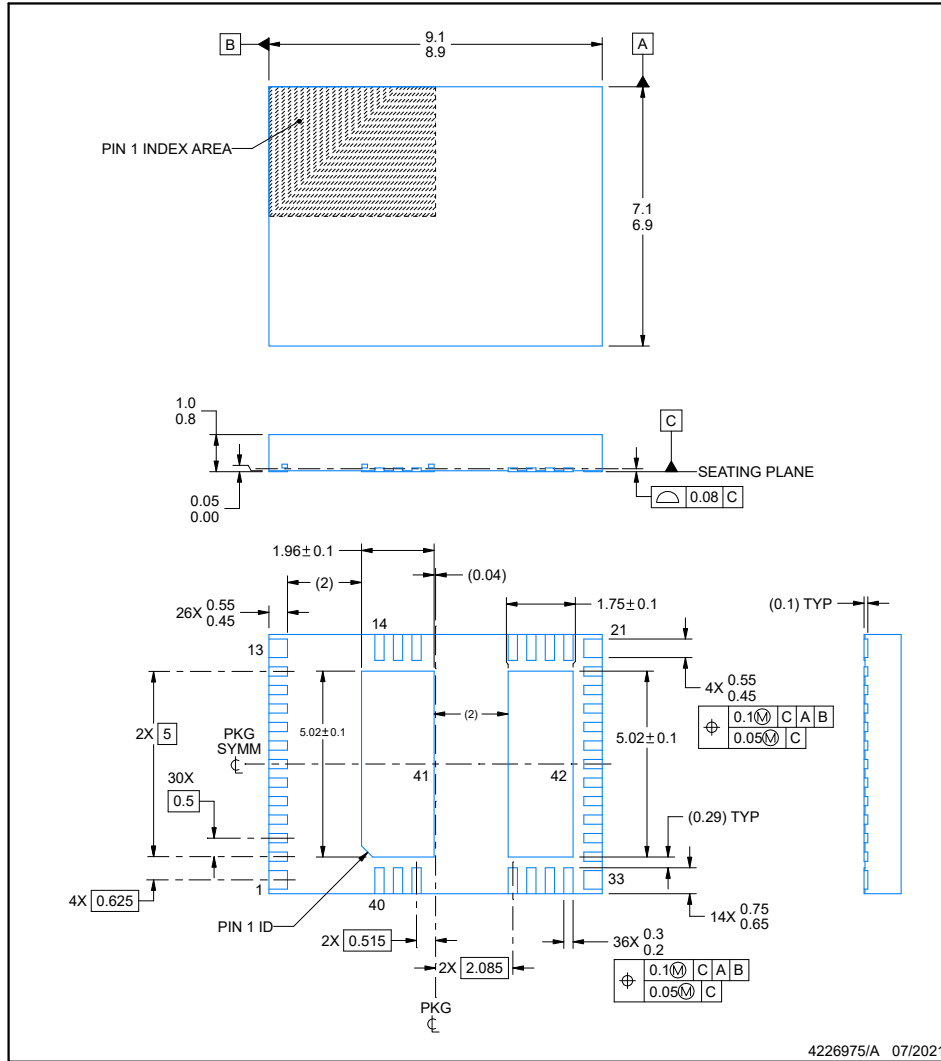

NOTES:

1. All linear dimensions are in millimeters. Any dimensions in parenthesis are for reference only. Dimensioning and tolerancing per ASME Y14.5M.
2. This drawing is subject to change without notice.
3. The package thermal pad must be soldered to the printed circuit board for thermal and mechanical performance.

EXAMPLE BOARD LAYOUT

RRG0040A-C01

VQFN - 1.0 mm max height

PLASTIC QUAD FLATPACK - NO LEAD

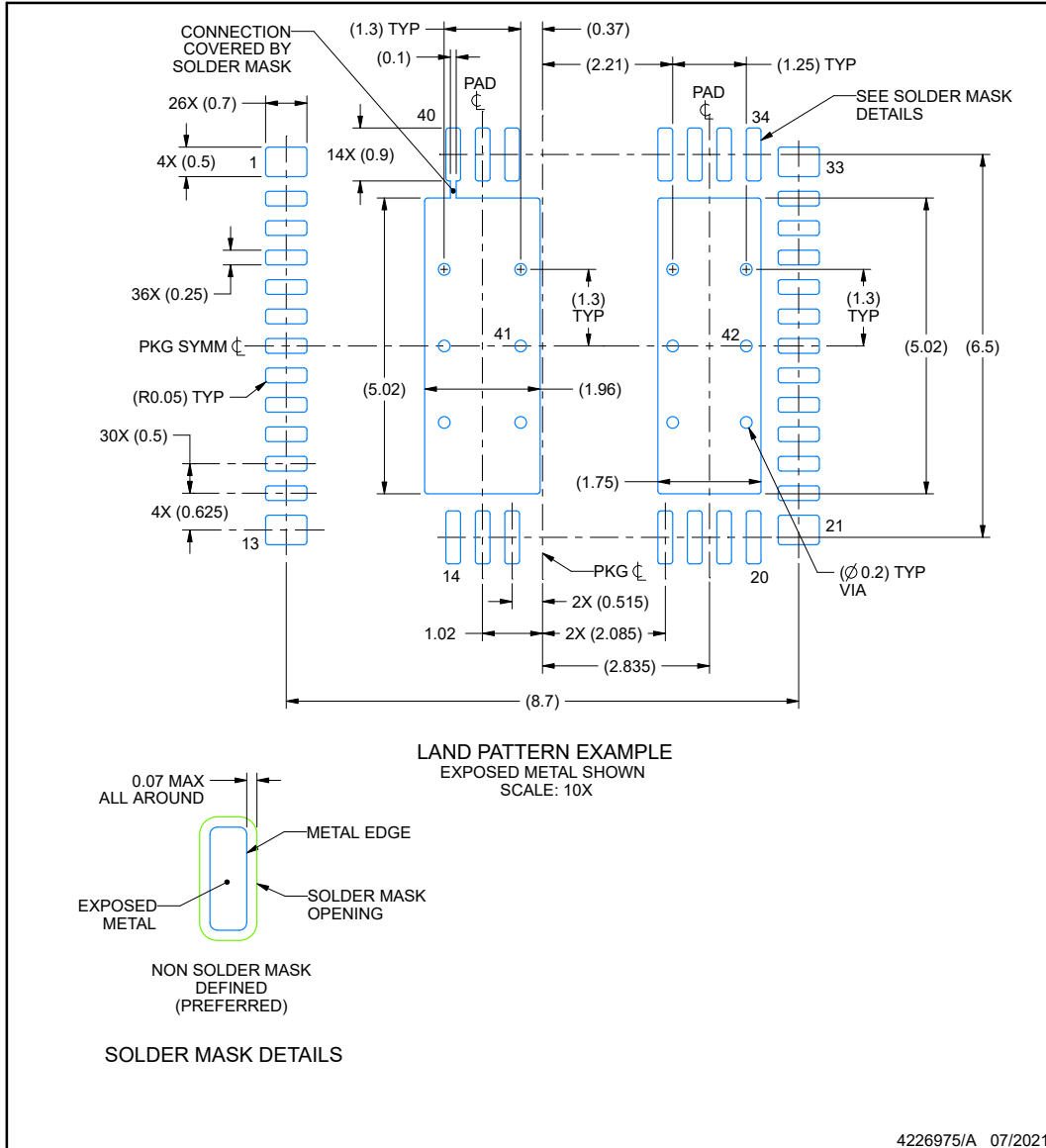

NOTES: (continued)

4. This package is designed to be soldered to a thermal pad on the board. For more information, see Texas Instruments literature number SLUA271 (www.ti.com/lit/slua271).
5. Vias are optional depending on application, refer to device data sheet. If some or all are implemented, recommended via locations are shown.

EXAMPLE STENCIL DESIGN

RRG0040A-C01

VQFN - 1.0 mm max height

PLASTIC QUAD FLATPACK - NO LEAD

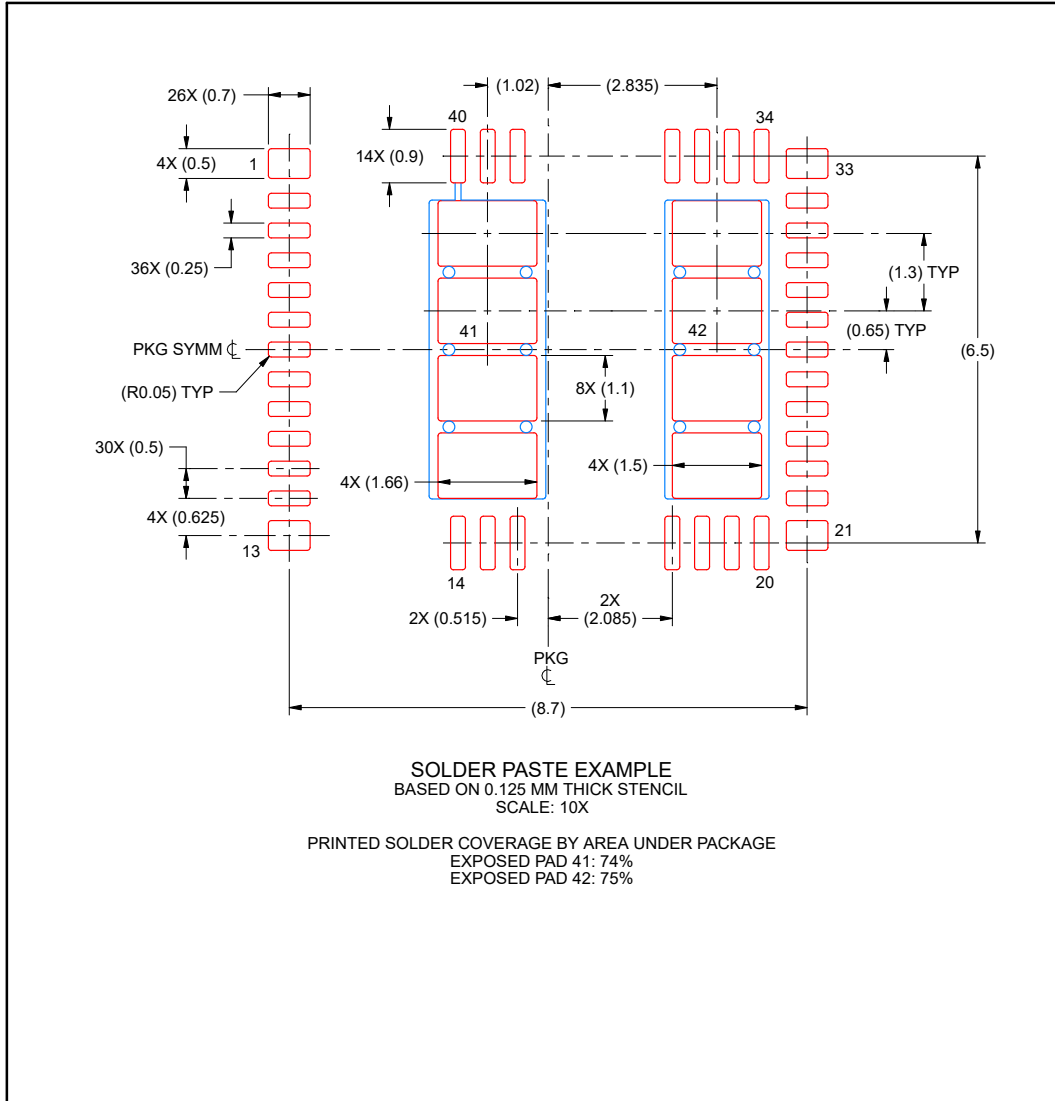

NOTES: (continued)

- 6. Laser cutting apertures with trapezoidal walls and rounded corners may offer better paste release. IPC-7525 may have alternate design recommendations.

PACKAGING INFORMATION

Orderable part number	Status (1)	Material type (2)	Package Pins	Package qty Carrier	RoHS (3)	Lead finish/ Ball material (4)	MSL rating/ Peak reflow (5)	Op temp (°C)	Part marking (6)
LMG2640RRGR	Active	Production	VQFN (RRG) 40	2000 LARGE T&R	ROHS Exempt	NIPDAU	Level-3-260C-168HRS	-40 to 125	LMG2640 NNNNC
LMG2640RRGR.A	Active	Production	VQFN (RRG) 40	2000 LARGE T&R	ROHS Exempt	NIPDAU	Level-3-260C-168HRS	See LMG2640RRGR	LMG2640 NNNNC

(1) **Status:** For more details on status, see our [product life cycle](#).

(2) **Material type:** When designated, preproduction parts are prototypes/experimental devices, and are not yet approved or released for full production. Testing and final process, including without limitation quality assurance, reliability performance testing, and/or process qualification, may not yet be complete, and this item is subject to further changes or possible discontinuation. If available for ordering, purchases will be subject to an additional waiver at checkout, and are intended for early internal evaluation purposes only. These items are sold without warranties of any kind.

(3) **RoHS values:** Yes, No, RoHS Exempt. See the [TI RoHS Statement](#) for additional information and value definition.

(4) **Lead finish/Ball material:** Parts may have multiple material finish options. Finish options are separated by a vertical ruled line. Lead finish/Ball material values may wrap to two lines if the finish value exceeds the maximum column width.

(5) **MSL rating/Peak reflow:** The moisture sensitivity level ratings and peak solder (reflow) temperatures. In the event that a part has multiple moisture sensitivity ratings, only the lowest level per JEDEC standards is shown. Refer to the shipping label for the actual reflow temperature that will be used to mount the part to the printed circuit board.

(6) **Part marking:** There may be an additional marking, which relates to the logo, the lot trace code information, or the environmental category of the part.

Multiple part markings will be inside parentheses. Only one part marking contained in parentheses and separated by a "-" will appear on a part. If a line is indented then it is a continuation of the previous line and the two combined represent the entire part marking for that device.

Important Information and Disclaimer: The information provided on this page represents TI's knowledge and belief as of the date that it is provided. TI bases its knowledge and belief on information provided by third parties, and makes no representation or warranty as to the accuracy of such information. Efforts are underway to better integrate information from third parties. TI has taken and continues to take reasonable steps to provide representative and accurate information but may not have conducted destructive testing or chemical analysis on incoming materials and chemicals. TI and TI suppliers consider certain information to be proprietary, and thus CAS numbers and other limited information may not be available for release.

In no event shall TI's liability arising out of such information exceed the total purchase price of the TI part(s) at issue in this document sold by TI to Customer on an annual basis.

TAPE AND REEL INFORMATION

QUADRANT ASSIGNMENTS FOR PIN 1 ORIENTATION IN TAPE

*All dimensions are nominal

Device	Package Type	Package Drawing	Pins	SPQ	Reel Diameter (mm)	Reel Width W1 (mm)	A0 (mm)	B0 (mm)	K0 (mm)	P1 (mm)	W (mm)	Pin1 Quadrant
LMG2640RRGR	VQFN	RRG	40	2000	330.0	16.4	9.3	7.3	1.2	12.0	16.0	Q1

TAPE AND REEL BOX DIMENSIONS

*All dimensions are nominal

Device	Package Type	Package Drawing	Pins	SPQ	Length (mm)	Width (mm)	Height (mm)
LMG2640RRGR	VQFN	RRG	40	2000	367.0	367.0	38.0

IMPORTANT NOTICE AND DISCLAIMER

TI PROVIDES TECHNICAL AND RELIABILITY DATA (INCLUDING DATASHEETS), DESIGN RESOURCES (INCLUDING REFERENCE DESIGNS), APPLICATION OR OTHER DESIGN ADVICE, WEB TOOLS, SAFETY INFORMATION, AND OTHER RESOURCES "AS IS" AND WITH ALL FAULTS, AND DISCLAIMS ALL WARRANTIES, EXPRESS AND IMPLIED, INCLUDING WITHOUT LIMITATION ANY IMPLIED WARRANTIES OF MERCHANTABILITY, FITNESS FOR A PARTICULAR PURPOSE OR NON-INFRINGEMENT OF THIRD PARTY INTELLECTUAL PROPERTY RIGHTS.

These resources are intended for skilled developers designing with TI products. You are solely responsible for (1) selecting the appropriate TI products for your application, (2) designing, validating and testing your application, and (3) ensuring your application meets applicable standards, and any other safety, security, regulatory or other requirements.

These resources are subject to change without notice. TI grants you permission to use these resources only for development of an application that uses the TI products described in the resource. Other reproduction and display of these resources is prohibited. No license is granted to any other TI intellectual property right or to any third party intellectual property right. TI disclaims responsibility for, and you fully indemnify TI and its representatives against any claims, damages, costs, losses, and liabilities arising out of your use of these resources.

TI's products are provided subject to [TI's Terms of Sale](#), [TI's General Quality Guidelines](#), or other applicable terms available either on ti.com or provided in conjunction with such TI products. TI's provision of these resources does not expand or otherwise alter TI's applicable warranties or warranty disclaimers for TI products. Unless TI explicitly designates a product as custom or customer-specified, TI products are standard, catalog, general purpose devices.

TI objects to and rejects any additional or different terms you may propose.

Copyright © 2026, Texas Instruments Incorporated

Last updated 10/2025