

# NS486SXF

*NS486(TM)SXF Optimized 32-Bit 486-Class Controller with On-Chip  
Peripherals for Embedded Systems*



Literature Number: SNOS774A

## NS486™SXF Optimized 32-Bit 486-Class Controller with On-Chip Peripherals for Embedded Systems

### General Description

The NS486SXF is a highly integrated embedded system controller incorporating an Intel486™-class 32-bit processor, all of the necessary System Service Elements, and a set of peripheral I/O controllers tailored for embedded control systems. It is ideally suited for a wide variety of applications running in a segmented protect-mode environment.

### Key Features

- 100% compatible with VxWorks®, VRTX®, QNX® Neutrino, pSOS+™, and other popular real-time executives and operating system kernels
- Intel486 instruction set compatible (protected mode only) with optimized performance
- CPU includes a 1 Kbyte Instruction Cache
- Operation at 25 MHz with 5V supply
- Low cost 160-pin PQFP package
- Industry standard interrupt controller, timers, real time clock, UART with IrDA v1.0 (Infrared Data Association) port

- Intel 82365 compatible PCMCIA interface
- Protected WATCHDOG™ timer
- Optimized DRAM Controller (supports two banks, up to 8 Mbytes each)
- Up to nine versatile, programmable chip selects
- Glueless interface to ISA peripherals
- Arbitration support for auxiliary processor
- Four external DMA channels (max. transfer rate of 25 MByte/sec @ 25 MHz) support many transfer modes
- High performance IEEE 1284 (ECP) Bidirectional Parallel Port
- MICROWIRE™/Access.bus synchronous serial interfaces
- LCD Controller for an up to 4 grey scale supertwist Liquid Crystal Displays up to 480 X 320
- Reconfigurable I/O: Up to 29 I/O pins can be used as general purpose bidirectional I/O lines
- Flexible, programmable, multilevel power saving modes maximize power savings

### NS486SXF Single-Chip Embedded Controller

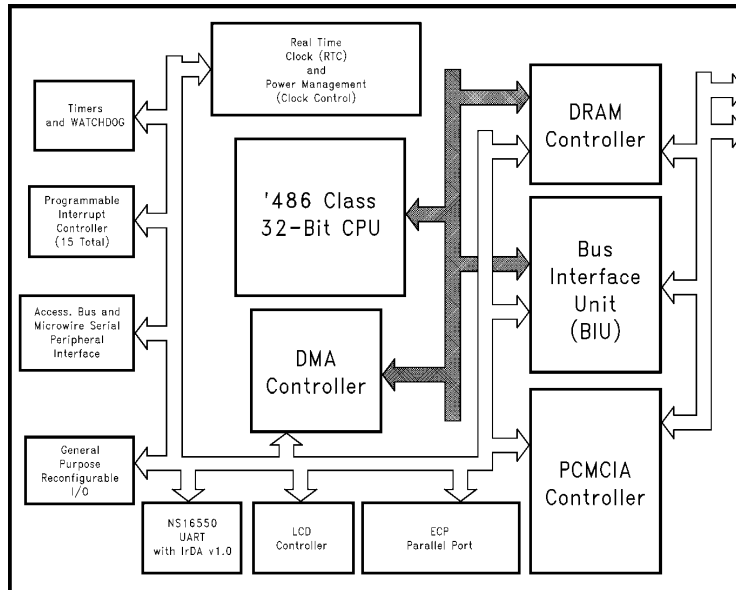

TL/EE/12514-1

TRI-STATE® is a registered trademark of National Semiconductor Corporation.  
 NS486™, WATCHDOG™ and MICROWIRE™ are trademarks of National Semiconductor Corporation.  
 Intel486™ is a trademark of Intel Corporation.  
 QNX® is a registered trademark of QNX Software Systems, Inc.  
 VRTX® is a registered trademark of Microtek Research, Inc.  
 VxWorks® is a registered trademark of Wind River Systems, Inc.  
 pSOS+™ is a trademark of Integrated Systems Inc.  
 PowerPack® is a registered trademark of Microtek International.

## Table of Contents

### 1.0 SYSTEM OVERVIEW

- 1.1 NS486SXF System Overview
- 1.2 32-bit Processor Core
- 1.3 System Service Elements
  - 1.3.1 DRAM Controller
  - 1.3.2 DMA Controller
  - 1.3.3 Programmable Interval Timer
  - 1.3.4 WATCHDOG Timer
  - 1.3.5 Interrupt Controller
  - 1.3.6 Real Time Clock/Calendar
  - 1.3.7 Power Management Features
- 1.4 NS486SXF System Bus
- 1.5 Other On-board Peripherals
  - 1.5.1 Reconfigurable I/O Lines
  - 1.5.2 IEEE 1284 Bidirectional Port
  - 1.5.3 PCMCIA Interface
  - 1.5.4 MICROWIRE/Access.bus Interface
  - 1.5.5 UART Serial Port
  - 1.5.6 LCD Controller
- 1.6 ICE Support
- 1.7 Other Issues

### 2.0 PIN DESCRIPTION TABLES

### 3.0 DEVICE SPECIFICATIONS

- 3.1 DC Electrical Specifications  $5V \pm 5\%$ 
  - 3.1.1 Recommended Operating Conditions
  - 3.1.2 Absolute Maximum Ratings (Notes 2 and 3)
  - 3.1.3 Capacitance:  $T_A = 25^\circ\text{C}$ ,  $f = 1 \text{ MHz}$
  - 3.1.4 DC Characteristics
- 3.2 General AC Specifications
  - 3.2.1 Power Ramp Times
  - 3.2.2 PWRGOOD and Power Rampdown Timing
- 3.3 AC Switching Specifications
  - 3.3.1 DRAM Interface Timing Specification
  - 3.3.2 ISA-like Bus Cycles Timing Specification
  - 3.3.3 Ready Feedback Timing Specifications
  - 3.3.4 OSCX1 AC Specification
  - 3.3.5 Peripheral Timing Specifications
- 3.4 Physical Description

## List of Figures

- FIGURE 1-1. NS486SXF Internal Resource to Pins Map
- FIGURE 1-2. NS486SXF Internal Busses
- FIGURE 2-1. NS486SXF Package Pinout Diagram
- FIGURE 3-1. Switching Characteristic Measurement Waveforms
- FIGURE 3-2. More Switching Specifications
- FIGURE 3-3. Power Supply Rise and Fall
- FIGURE 3-4. PWGOOD in relation to  $V_{DD}$
- FIGURE 3-5. DRAM Timing Diagram
- FIGURE 3-6. ISA-like Bus Timing Diagram
- FIGURE 3-7. Ready Feedback Timing Diagram
- FIGURE 3-8. TTL Clock Input Timing Diagram
- FIGURE 3-9. DMA Controller Read Timing Diagram
- FIGURE 3-10. DMA Controller Write Timing Diagram
- FIGURE 3-11. PIC Timing Diagram
- FIGURE 3-12. Memory Read Timing
- FIGURE 3-13. Memory Write Timing Diagram
- FIGURE 3-14. I/O Read Timing
- FIGURE 3-15. I/O Write Timing Diagram
- FIGURE 3-16. Access.bus Timing Diagram
- FIGURE 3-17. UART Baud Rate and Infrared Clocks
- FIGURE 3-18. UART IRQ Timing
- FIGURE 3-19. UART Modem Control Timing
- FIGURE 3-20. LCD Controller Timing Diagram
- FIGURE 3-21. Testmode Timing Diagram
- FIGURE 3-22. Plastic Package Specifications

## List of Tables

TABLE 2-1.	Bus Interface Unit Pins
TABLE 2-2.	DMA Control Pins
TABLE 2-3.	DRAM Control Pins
TABLE 2-4.	Power Pins
TABLE 2-5.	Reset Logic Pins
TABLE 2-6.	Auxiliary Processor Interface Pins
TABLE 2-7.	Test Pins
TABLE 2-8.	Interrupt Control Pins
TABLE 2-9.	Real Time Clock Pins
TABLE 2-10.	LCD Interface Pins
TABLE 2-11.	Oscillator Pins
TABLE 2-12.	HP-SIR/UART Pins
TABLE 2-13.	PCMCIA pins
TABLE 2-14.	IEEE-1284 Port (ECP Mode)
TABLE 2-15.	Timer Pins
TABLE 2-16.	3-Wire Serial I/O Pins
TABLE 2-17.	General Purpose Chip Select Pins
TABLE 2-18.	Summary of Reconfigurable I/O Pins
TABLE 3-1.	$V_{DD}$ Rise and Fall Times
TABLE 3-2.	$V_{DD}$ Rampdown vs PWRGOOD
TABLE 3-3.	4 Cycle Page Miss Preliminary Specifications
TABLE 3-4.	3 Cycle Miss Preliminary Specifications
TABLE 3-5.	No Command Delay ISA-like Bus Specifications
TABLE 3-6.	One Programmed Command Delay ISA-like Bus Specifications
TABLE 3-7.	Ready Signal Timing Specifications
TABLE 3-8.	TTL Clock Input Specification
TABLE 3-9.	DMA Controller Specifications
TABLE 3-10.	PIC Timing Specifications
TABLE 3-11.	Parallel Port Compatibility Mode Handshake Timing Values
TABLE 3-12.	Parallel Port IEEE 1284 Mode Handshake Timing Values
TABLE 3-13.	PCMCIA Memory Read Timing Specifications
TABLE 3-14.	Memory Write Timing
TABLE 3-15.	PCMCIA I/O Read Specifications
TABLE 3-16.	PCMCIA I/O Write Specifications
TABLE 3-17.	Access.Bus Timing Specifications
TABLE 3-18.	LCD Controller Timing Specifications

# 1.0 System Overview

## 1.1 NS486SXF SYSTEM OVERVIEW

The **NS486SXF** is a highly integrated embedded system controller. It includes an Intel486-class 32-bit processor, all resources required for the System Service Elements of a Real-Time Executive, and a generous set of peripherals. This "system-on-a-chip" is ideal for implementing a wide variety of embedded applications. These include (but are not limited to) fax machines, multifunction peripherals (fax, scanners, printers) mobile companions (both organizer and communicator), television set-top boxes, and telephones (mobile and desktop).

The 32-bit processor core executes all of the Intel486 instructions with a similar number of clocks per instruction. An on-board 1 kbyte instruction cache provides for efficient execution from ROM. Intel486 debug features are supported. The processor has been optimized for operating system kernels such as VRTX, VxWorks, pSOS+ and QNX. These environments only need the '486 protected mode operation (no real mode or virtual 8086 support), flat or linear memory addressing (no virtual memory paging), and floating point execution in software only (no co-processor interface).

In fact, the **NS486SXF** includes all of the System Service Elements required by a typical kernel, including an efficient DRAM controller that supports page-mode DRAMs for data

cache-like performance; a six-channel DMA controller with two channels supporting data transfers from on-chip peripherals (the IEEE 1284 ECP or Extended Capabilities Port, and the LCD controller), and four channels supporting external devices such as scanners, and print engines; three timer channels (including one configured as a protected WATCHDOG Timer); two programmable 8259 interrupt controllers provide 15 on-chip interrupt sources; an industry standard real time clock and calendar (RTC) with battery backup; and support for comprehensive power management schemes.

In addition, the **NS486SXF** also incorporates the key I/O peripherals required for implementing a wide variety of embedded applications: an IEEE 1284 Bidirectional Parallel Port that includes both Host and Slave modes, an Intel 82365-compatible PCMCIA controller for one card slot, an industry standard high-performance NS16550-compatible UART with HP-SIR and IrDA v1.0 infrared option, an LCD panel interface with DMA supported refresh for many of the standard resolutions, an 8254 timer, and a general purpose 2- or 3-wire synchronous serial interface for easy interface to low-cost EEPROMs and other serial peripherals. System expansion is supported with nine programmable Chip Select (CS) signals and a generic ISA-type bus interface for external devices and memory.

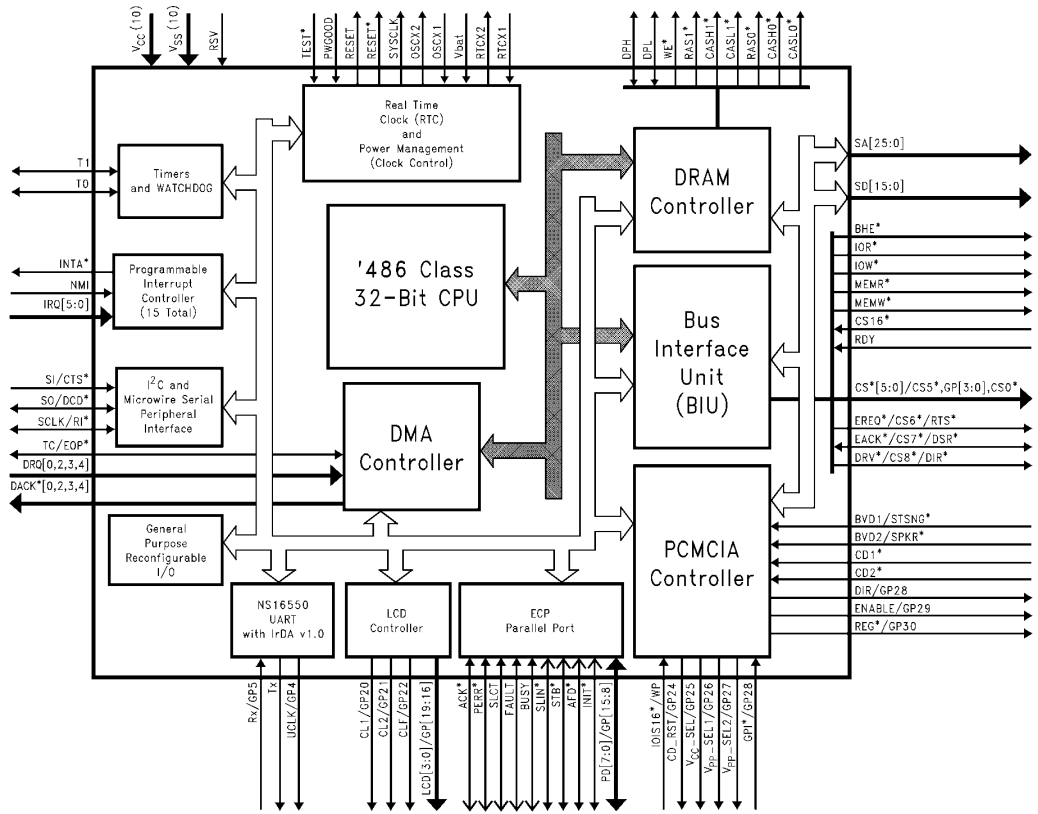

FIGURE 1-1. NS486SXF Internal Resource to Pins Map

TL/EE/12514-2

## 1.0 System Overview (Continued)

Certain I/O lines not being used by disabled peripherals can be reconfigured for use as general purpose bidirectional I/O lines (up to 29 pins). This gives the designer maximum flexibility in designing various systems using the **NS486SXF** device. It is expected that an **NS486SXF** system will minimally include the **NS486SXF** system controller with on-board processor and I/O devices, boot ROM, and working RAM memory. Many applications will not require any additional I/O support.

Finally, the **NS486SXF** implements a very flexible power management scheme that permits selective control of individual I/O subsystems, with varying levels of power consumption.

**NS486SXF** provides a cost-effective hardware platform for the design and implementation of a wide range of office automation and communication systems. With its powerful embedded '486-class processor, comprehensive set of on-chip peripheral controllers, flexible power management structure and reconfigurable I/O lines, **NS486SXF** makes possible a variety of end-user systems based on the same hardware. Because of its optimized design and on-board resources, a very cost effective system can be achieved.

### 1.2 32-BIT PROCESSOR CORE

The **NS486SXF** processor core is an implementation of the protected mode '486 instruction set architecture, optimized using a RISC-like design philosophy for embedded applications. Using this approach, the most frequently used instructions are optimized, and on an average execute in a lower number of clock cycles than a '486.

The **NS486SXF** features a three stage pipeline, efficient instruction prefetching mechanism, and single cycle instruction decoding for most instructions. Additionally, a 1 kbyte instruction cache and single cycle DRAM access provide higher memory performance than a larger unified cache implementation.

The **NS486SXF** processor provides the same programming model and register set as the standard '486 except that real mode, virtual memory, and floating point support have been eliminated. These features have little or no impact in embedded applications and save significant silicon real estate. At reset, unlike the standard '486, the **NS486SXF** starts up in protected mode instead of real mode. All '486 instructions appropriate to protected mode and our hardware configuration are supported, including debug instructions.

The **NS486SXF** is initially available to run 25 MHz at 5V. The processor clock is obtained by dividing the crystal frequency by two. For example, a 25 MHz **NS486SXF** runs with a 50 MHz crystal oscillator as the master clock.

As a result of our innovative design, the **NS486SXF** achieves performance equivalent to a standard '486 with less circuitry. This translates into reduced power consumption and a lower overall system cost. It also makes the **NS486SXF** ideal for "green" systems and battery operated systems.

### 1.3 SYSTEM SERVICE ELEMENTS

The **NS486SXF** controller provides the basic hardware resources required for the O/S-defined System Service Elements. These include a DRAM controller, a DMA controller, programmable interval timer, a protected WATCHDOG timer, a programmable interrupt controller, a real-time clock and calendar, and comprehensive power management features.

#### 1.3.1 DRAM Controller

The **NS486SXF** DRAM controller supports one or two adjustable-sized banks of dynamic RAM using a 16-bit data path. Support is provided for byte parity (if desired), requiring the DRAM banks to be 18 bits wide when parity is enabled. Banks can be up to 8 Mbytes in size. The DRAM controller supports page mode read and write operations and can also support both byte and word accesses. All access control signals for read, write and parity checking are generated as well as an automatic and programmable CAS-before-RAS refresh. If self-refresh DRAMs are used, refresh can be disabled, saving power.

**NS486SXF** provides flexible support for use of a number of different DRAM configurations, using popular DRAM devices. Access is optimized for fast page mode DRAMs, and they will provide the highest performance with contiguous data. When accessing data bytes or words in the same DRAM page, the data access is in one cycle. This performance provides fast data access times without the overhead of a separate data cache. Page sizes can be 512, 1024, 2048 or 4096 bytes. Flexibility for DRAM timing is provided through programming of the DRAM controller registers: 3 or 4 cycle page miss accesses and extended CAS cycles can be selected.

Memory bank 0 starts at address 0h; memory bank 1 can start at any address in the 128 Mbyte address map that is a multiple of its size.

#### 1.3.2 DMA Controller

The **NS486SXF** Direct Memory Access (DMA) controller is a high speed 16-bit controller that improves system performance by off-loading from the processor the task of managing data transfers to and from memory and external devices. Data transfers are done independently from the processor at a maximum data rate of 2 bytes per 2 clock cycles. (A 25 MHz clock yields a 25 megabyte per second transfer rate.)

There are six independent DMA channels. Requestor and target addresses have a maximum addressable memory range of 64 Mbytes. Three standard transfer modes, single, block and demand, are provided giving the designer a wide range of DMA options. A special transfer type, cascade-master, allows an external master to access the **NS486SXF** ISA-like bus. Normal transfers can be from memory to memory, memory to I/O and I/O to memory. DMA transfers are controlled by DMA control registers in the **NS486SXF** control register I/O map.

#### 1.3.3 Programmable Interval Timer

The **NS486SXF** programmable interval timer is compatible with the Intel 8254 programmable interval timer and contains three identical timers (CH0-CH2). CH0 and CH1 can be used to generate accurate timing delays under software control. CH2 may be configured to provide a WATCHDOG timer function.

#### 1.3.4 WATCHDOG Timer

The **NS486SXF** WATCHDOG timer, CH2, is a protected 16-bit timer that can be used to prevent system "lockups or hangups." It uses a 1 kHz clock generated by the on-chip real-time clock circuit. If the WATCHDOG timer is enabled and times out, a reset or interrupt will be generated allowing graceful recovery from an unexpected system lockup.





## 1.0 System Overview (Continued)

When the CPU is in idle mode, the BIU is designed to mimic the CPU during DMA interchanges between memory and peripherals. By responding to DRQs and generating DACK, and HOLDA signals as required, the BIU eliminates the need to reactivate the CPU during such transfers as screen updates from memory to the LCD controller. This gives the designer added flexibility in conserving power while maintaining basic system functions.

### 1.5 OTHER ON-BOARD PERIPHERALS

In addition to those peripherals and system control elements needed for System Service Elements, the **NS486SXF** also includes a number of I/O controllers and resources that make implementing a complete embedded system possible with just a single-chip **NS486SXF** controller. These include an IEEE 1284 Extended Capabilities Port, a serial UART port, a LCD controller, a PCMCIA interface and a MICROWIRE or Access.bus synchronous serial bus interface. In addition, unused I/O controllers free up their I/O pins for general purpose use.

#### 1.5.1 Reconfigurable I/O Lines

The **NS486SXF** supports reconfigurable I/O. For example, if the UART, ECP Parallel Port, LCD or PCMCIA functions are not being used, the I/O pins associated with them can be reconfigured as general purpose bidirectional I/O pins. Up to 29 pins can be reconfigured for this purpose. This capability makes the **NS486SXF** extremely versatile and ideal for supporting different end product configurations with a single **NS486SXF** device.

#### 1.5.2 IEEE 1284 Bidirectional Port

The **NS486SXF** parallel port is a multifunction 8-bit parallel port that is compatible with the IEEE 1284 bidirectional parallel port standard. The operation of the parallel port is set by the content of the **NS486SXF** parallel port I/O control registers. The port can operate in one of two modes: a standard parallel port mode (PC compatible), or a full Extended Capabilities Port (ECP) mode. The **NS486SXF** ECP port can support both Host and Slave ECP mode. In slave mode, the **NS486SXF** becomes a versatile microprocessor for parallel I/O peripheral devices.

#### 1.5.3 PCMCIA Interface

The **NS486SXF** PCMCIA interface supports the direct connection of a single PCMCIA 2.0 IC card. Exchange Card Architecture (ExCA release 1.50) compatibility and eExecute In Place (XIP) capability is also provided.

Accessing the PCMCIA interface switches the external bus automatically into the PCMCIA mode and permits Memory Window Mapping and Address Offset to be handled inside the **NS486SXF** device. Power management and "hot" card insertion/removal options can be implemented using external buffering, if required.

#### 1.5.4 MICROWIRE/Access.bus Interface

The **NS486SXF** MICROWIRE/Access.bus interface provides for full support of either the three-wire MICROWIRE or the two-wire Access.bus serial interfaces. MICROWIRE has an alternate clock phasing option that supports the SPI bus protocol as well. These industry standard interfaces permit easy interfacing to a wide range of low-cost specialty memories and I/O devices. These include EEPROMs, SRAMs, timers, clock chips, A/D converters, D/A converters, and peripheral device drivers.

#### 1.5.5 UART Serial Port

The **NS486SXF** UART provides complete NS16550 (PC standard) serial communications port compatibility including the performance enhancing 16-byte deep FIFO. It performs serial-to-parallel conversion from external devices to the **NS486SXF** and parallel-to-serial conversion from the **NS486SXF** to external peripherals. Full modem control can be supported.

A serial IrDA v1.0 and HP-SIR (infrared) mode is also supported, making possible low-cost wireless communications between an **NS486SXF**-based system and other wireless infrared systems.

#### 1.5.6 LCD Controller

The **NS486SXF** LCD controller is capable of controlling a variety of monochrome supertwist LCD configurations including 320x240, 320x200 and 480x320 black and white or grayscale graphics LCD modules equipped with self-contained screen drivers. It uses a video frame buffer in system DRAM with either a 1- or 2-bit per pixel grayscale. A 60 Hz to 90 Hz frame refresh rate is supported. Special controls permit the fine tuning of display characteristics to precisely optimize visual display quality.

#### 1.6 ICE SUPPORT

National Semiconductor has worked closely with Microtek International to provide hardware in-circuit emulator support for the **NS486SXF**. The Microtek product (PowerPack® EA-NS486) uses a special bondout version of the **NS486SXF** to deliver a full-featured hardware emulator that is capable of tracing on chip activity, including peripheral interrupt and I/O activity. The emulator runs at full speed, and supports overlay memory and multiple triggers.

#### 1.7 OTHER ISSUES

**NS486SXF** provides a comprehensive set of on-board peripherals. Also, it is designed to easily interface to external peripherals. In addition to this ISA-like bus which supports ISA-compatible peripherals, the **NS486SXF** provides an interface to an external master with a shared memory space. The external master or auxiliary processor interface allows low cost interfacing to shared external memory belonging to other external masters (including another **NS486SXF** controller).

To program the resources of the **NS486SXF**, a set of internal control registers exists. These registers provide precise control over all internal resources and the setup of external **NS486SXF** control signals. It is the designer's responsibility to ensure the proper initialization of the registers in this I/O map.

In addition, the **NS486SXF** core processor itself requires several descriptor tables and initialization parameters that must be set by user-written start-up software.

The **NS486SXF** is designed from the ground up for optimum price/performance in embedded systems. This makes the **NS486SXF** the logical choice as the base hardware platform for executing an embedded operating system kernel such as those available from Microtec International, Wind River, ISI, QNX, and many others. Any Operating System or Real-Time Executive that will operate in a segmented or flat memory model protect mode environment is a suitable complement to the **NS486SXF**.

Also, there are many third party tool sets that will allow an executable application to be built to run directly on the target hardware without an O/S environment.

## 2.0 Pin Description Tables

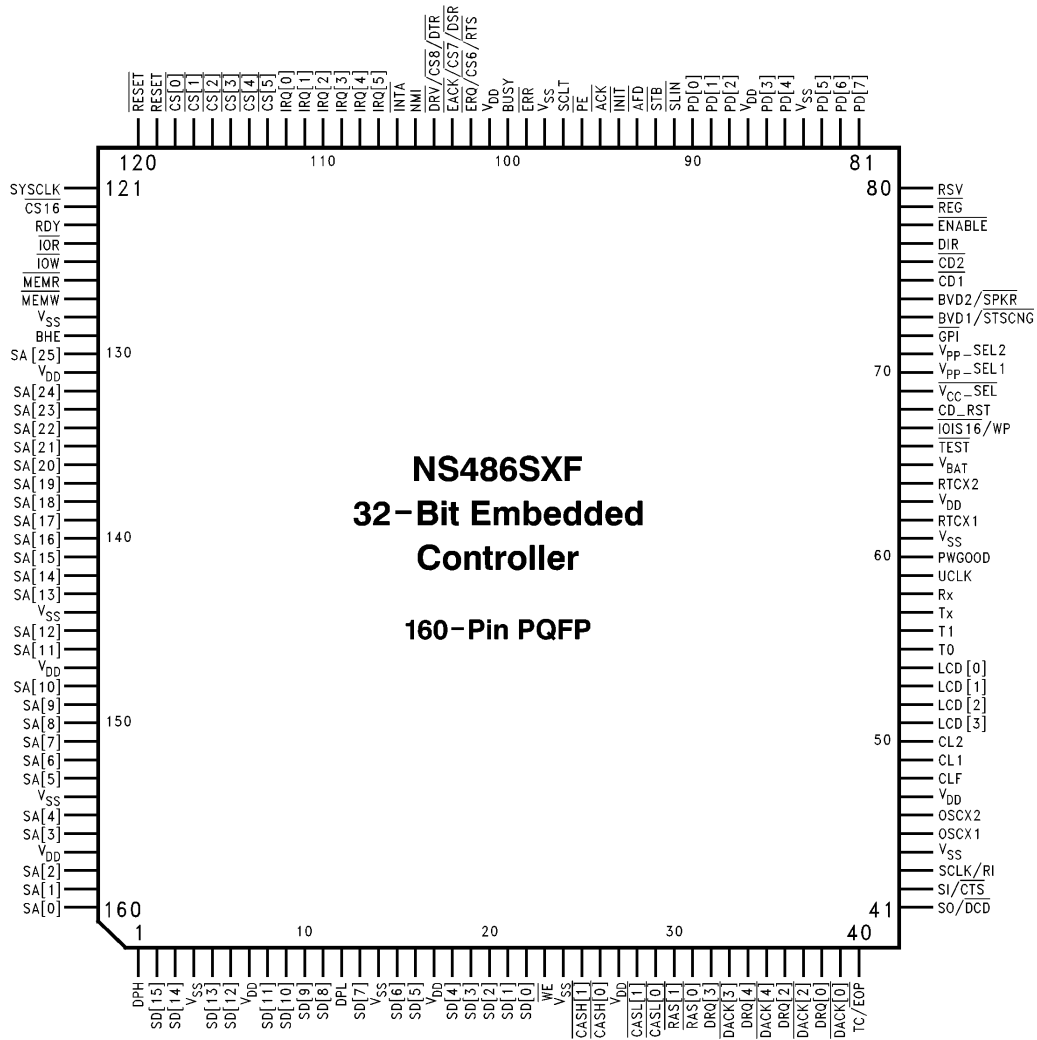

TL/EE/12514-4

FIGURE 2-1. NS486SXF Package Pinout Diagram

The **NS486SXF** single chip controller is provided in a compact 160-pin, industry standard JEDEC PQFP package. The following tables detail the Symbol, Type, and Description of each pin. The tables divide the pins into functional groups as follows: Bus Interface Unit Pins, DMA Control Pins, DRAM Control Pins, Power Pins, Reset Logic Pins, Auxiliary Processor Interface Pins, Test Pins, Interrupt Control Pins, Real Time Clock Pins, LCD Interface Pins, Oscillator Pins, UART/IrDA Pins, PCMCIA Pins, IEEE-1284 Port (ECP

Mode) Pins, Timer Pins, 3-Wire Serial I/O Pins, General Purpose Chip Select Pins, and Reconfigurable I/O Pins. Twenty-nine I/O pins are multipurpose. In their standard modes, they perform specific I/O controller functions. When those particular I/O functions are not required in the system, however, those pins can be reprogrammed to become general purpose, bidirectional I/O lines.

**Note:** In the above figure and in the following tables, all active low signals are shown with an overbar.

## 2.0 Pin Description Tables (Continued)

**TABLE 2-1. Bus Interface Unit Pins**

Symbol	Pins	Type	Function
SA[25:0]	130, 132, 133, 134, 135, 136, 137, 138, 139, 140, 141, 142, 143, 145, 146, 148, 149, 150, 151, 152, 153, 155, 156, 158, 159, 160	O	<b>System Address bus.</b> These output-only signals carry the latched address for the current access. DRAM accesses multiplex the row and column addresses for the DRAMs on the SA[12:1] pins. During Interrupt Acknowledge cycles, the internal master interrupt controller's cascade line signals, CAS[2:0], are driven onto SA[25:23], respectively. SA[0] is sampled at the end of reset to determine if the part will run normally or enter ICE TRI-STATE mode.
SD[15:0]	2, 3, 5, 6, 8, 9, 10, 11, 13, 15, 16, 18, 19, 20, 21, 22	I/O	<b>System Data bus:</b> This bi-directional data bus provides the data path for all memory and I/O accesses. During transfers with 8-bit devices, the upper data byte is not used (SD[15:8]).
$\overline{\text{SBHE}}$	129	O	<b>Byte High Enable.</b> This active-low signal indicates that the high byte (odd address byte) is being transferred. External 16-bit devices should use this signal to help them determine that a data byte is to be transferred on the upper byte of the System Data bus (SD[15:8]). 8-bit devices should ignore this signal. $\overline{\text{SBHE}}$ is sampled at the end of power good reset to determine if the boot ROM is 8- or 16-bit wide.
$\overline{\text{IOR}}$	124	O	<b>IO Read command.</b> This active-low signal instructs an I/O device to place data onto the system data bus.
$\overline{\text{IOW}}$	125	O	<b>IO Write command.</b> This active-low signal indicates to an I/O device that a write operation is in process on the system bus.
$\overline{\text{MEMR}}$	126	O	<b>MEMory Read command.</b> This active-low signal instructs a memory mapped device to place data onto the system data bus.
$\overline{\text{MEMW}}$	127	O	<b>MEMory Write command.</b> This active-low signal indicates to a memory mapped device that a write operation is in process on the system bus.
$\overline{\text{CS16}}$	122	I/O	<b>Chip Select 16-bit.</b> This active-low feedback signal indicates that the device being accessed is a 16-bit device. This signal should be driven by external devices with an open collector driver. If a chip select is programmed to force 16-bit accesses, this signal will be asserted (low) during the access.
RDY	123	I	<b>ReaDY.</b> An external device may drive this signal inactive low to insert wait states and extend the external bus cycle. This signal should be driven with an open collector or be TRI-STATE driven.

## 2.0 Pin Description Tables (Continued)

**TABLE 2-2. DMA Control Pins**

Symbol	Pins	Type	Function
DRQ[4], DRQ[3], DRQ[2], DRQ[0]	34, 32, 36, 38	I	<b>DMA ReQuest.</b> A DRQn signal requests the internal DMA Controller to transfer data between the Requesting Device and memory.
$\overline{\text{DACK}}[4],$ $\overline{\text{DACK}}[3],$ $\overline{\text{DACK}}[2],$ $\overline{\text{DACK}}[0]$	35, 33, 37, 39	O	<b>DMA ACKnowledge:</b> When the CPU has relinquished control of the bus to a requesting DMA channel, the appropriate active-low $\overline{\text{DACK}}n$ signal acknowledges the winning DRQn.
TC/ $\overline{\text{EOP}}$	40	I/O	<b>Terminal Count/End Of Process:</b> This signal may operate either as a terminal count output or an active-low End of Process input. As TC, an active-high pulse occurs on this signal when the terminal count for any DMA channel has been reached. As $\overline{\text{EOP}}$ , an external device may terminate the DMA transfer by driving this signal active-low.

**TABLE 2-3. DRAM Control Pins**

Symbol	Pins	Type	Function
$\overline{\text{RAS}}[1:0]$	30, 31	O	<b>Row Address Strobe.</b> On the falling edge of these active-low signals, Bank 1 and Bank 0 respectively, should latch in the row address off of SA[12:1]. If only one bank of DRAMs are supported, $\overline{\text{RAS}}0$ will support that bank and $\overline{\text{RAS}}1$ will be unused.
$\overline{\text{CASH}}[1:0]$	25, 26	O	<b>Column Address Strobe (High Byte).</b> These active-low signals indicate when the column access is being made to the high byte of DRAM Bank 1 and DRAM Bank 0 respectively. If only one bank of DRAMs are supported, $\overline{\text{CASH}}0$ will support the high byte of that bank and $\overline{\text{CASH}}1$ will be unused.
$\overline{\text{CASL}}[1:0]$	28, 29	O	<b>Column Address Strobe (Low Byte).</b> These active-low signals indicate when the column access is being made to the low byte of DRAM Bank 1 and DRAM Bank 0, respectively. If only one bank of DRAMs are supported, $\overline{\text{CASL}}0$ will support the low byte of that bank and $\overline{\text{CASL}}1$ will be unused.
$\overline{\text{WE}}$	23	O	<b>Write Enable.</b> Active low signal for writing the data into the DRAM bank.
DPH, DPL	1, 12	I/O	<b>DRAM Data Parity.</b> DRAM data parity may be enabled or disabled; if disabled these two pins will be unused. Otherwise, for DRAM writes the <b>NS486SXF</b> 's DRAM Controller will generate odd parity and drive the odd parity onto these two pins. For DRAM reads the <b>NS486SXF</b> 's DRAM Controller will read the values driven on these two pins and check it for odd parity in association with the appropriate data byte.

## 2.0 Pin Description Tables (Continued)

**TABLE 2-4. Power Pins**

Symbol	Pins	Type	Function
V <sub>DD</sub>	7, 17, 27, 47, 63, 87, 101, 131, 147, 157	I	+5V power to core and I/O.
V <sub>SS</sub>	4, 14, 24, 44, 61, 84, 98, 128, 144, 154	I	Ground to core and I/O.

**TABLE 2-5. Reset Logic Pins**

Symbol	Pins	Type	Function
RESET	119	O	<b>RESET</b> system output driver: This active high signal resets or initializes system peripheral logic during power up or during a low line voltage outage.
$\overline{\text{RESET}}$	120	O	Inverse of <b>RESET</b> for peripherals requiring active low reset.
PWGOOD	60	I	<b>PoWer GOOD</b> . This active-high (Schmitt Trigger) input will cause a hardware reset to the <b>NS486SXF</b> whenever this input goes low. This pin will typically be driven by the power supply and PWGOOD will remain low until the power supply determines that stable and valid voltage levels have been achieved.

**TABLE 2-6. Auxiliary Processor Interface Pins**

Symbol	Pins	Type	Function
$\overline{\text{EREQ/CS6/RTS}}$	102	O	This pin has three programmable options controlled by the Modem Signal Control Register (refer to the UART section): <ul style="list-style-type: none"> <li>1. <b>External bus REQuest</b> (active-low) to an auxiliary processor.</li> <li>2. <b>Chip Select 6</b> (active-low) pin.</li> <li>3. <b>Request To Send</b>. When low, this signal informs the MODEM or data set that the UART is ready to exchange data. The <b>RTS</b> output signal can be set to an active low by programming bit 2 (RTS) of the MODEM Control Register. A Master Reset operation sets this signal to its inactive (high) state. Loop mode operation holds this signal in its inactive state.</li> </ul>
$\overline{\text{EACK/CS7/DSR}}$	103	I/O	This pin has three possible programmable options controlled by the Modem Signal Control Register (refer to the UART section): <ul style="list-style-type: none"> <li>I 1. <b>External bus ACKnowledge</b> (active-low) from an auxiliary processor.</li> <li>O 2. <b>Chip Select 7</b> (active-low) pin.</li> <li>I 3. <b>Data Set Ready</b>. When low, it indicates that the MODEM or data set is ready to link with the UART. The <math>\overline{\text{DSR}}</math> signal is a MODEM status input whose condition can be tested by the CPU reading bit 5 (DSR) of the MODEM Status Register. Bit 5 is the complement of the <math>\overline{\text{DSR}}</math> signal. Bit 1 (DDSR) of the MODEM Status Register indicates whether the <math>\overline{\text{DSR}}</math> input has changed state since the previous reading of the MODEM Status Register.</li> </ul> <p><b>Note:</b> Whenever the DSR bit of the MODEM Status Register changes state, an interrupt is generated if the MODEM Status Interrupt is enabled.</p>
$\overline{\text{DRV/CS8/DTR}}$	104	O	This pin has three possible programmable options controlled by the Modem Signal Control Register (refer to the UART section): <ul style="list-style-type: none"> <li>1. DSP shared memory <b>DRiVe</b> control signal.</li> <li>2. <b>Chip Select 8</b> (active-low) pin.</li> <li>3. <b>Data Terminal Ready</b>. When low, this signal informs the MODEM or data set that the UART is ready to establish a communications link. The <math>\overline{\text{DTR}}</math> output signal can be set to an active low by programming bit 0 (DTR) of the MODEM Control Register to a high level. A Master Reset operation sets this signal to its inactive (high) state. Loop mode operation holds this signal in its inactive state.</li> </ul>

## 2.0 Pin Description Tables (Continued)

**TABLE 2-7. Test Pins**

Symbol	Pins	Type	Function
TEST	66	I/O	Reserved for testing and development system support.

**TABLE 2-8. Interrupt Control Pins**

Symbol	Pins	Type	Function
NMI	105	I	<b>Non-Maskable Interrupt.</b> This active-high signal will generate a non-maskable interrupt to the CPU when it is active high. Normally this signal is used to indicate a serious system error.
INTA	106	O	<b>INTerrupt Acknowledge.</b> During each interrupt acknowledge cycle this signal will strobe low; it should be used by external cascaded interrupt controllers.
IRQ[5:0]	107, 108, 109, 110, 111, 112	I	<b>Interrupt ReQuests.</b> These inputs are either rising edge or low-level sensitive interrupt requests, depending on the configuration of the internal interrupt controllers. These interrupt requests may also be programmed to support externally cascaded interrupt controller(s). The IRQ pins are also used to select a particular test in test mode. If the PCMCIA controller is enabled, IRQ[5] becomes the IREQ signal.

**TABLE 2-9. Real Time Clock Pins**

Symbol	Pins	Type	Function
RTCX1	62	I	<b>Real Time Clock</b> crystal oscillator input: 32 kHz crystal.
RTCX2	64	O	<b>Real Time Clock</b> crystal oscillator output: 32 kHz crystal.
V <sub>bat</sub>	65	I	External + battery input for real time clock.

**TABLE 2-10. LCD Interface Pins**

Symbol	Pins	Type	Function
LCD[3:0]	51, 52, 53, 54	O	<b>Data Output Word to LCD,</b> 1 = White, 0 = Blue/black.
CL2	50	O	Word <b>CLock</b> to LCD.
CL1	49	O	Row <b>CLock</b> to LCD.
CLF	48	O	Frame <b>CLock</b> to LCD.

**TABLE 2-11. Oscillator Pins**

Symbol	Pins	Type	Function
SYSCLK	121	O	<b>SYStem CLock.</b> This clock output pin will either be driven with a signal half the frequency of the OSCX1 input clock frequency or the CPU's clock frequency, which is determined in the Power Management Control Register 1. The source selection for this signal is determined by bit 1 of the Power Management Control Register 3.
OSCX1	45	I	<b>OSCillator Crystal 1</b> input. This pin should either be driven by a TTL oscillator or be connected to an external crystal circuit. This signal is the fundamental clock source for all clocked elements in the <b>NS486SXF</b> , except the Real-Time Clock, which has its own crystal pins.
OSCX2	46	O	<b>OSCillator Crystal 2</b> output. This is the output side of the <b>NS486SXF</b> on-chip circuitry provided to support an external crystal circuit. If a TTL oscillator drives OSCX1, this pin should be a no connect.

## 2.0 Pin Description Tables (Continued)

**TABLE 2-12. HP-SIR/UART Pins**

Symbol	Pins	Type	Function
Tx	57	O	UART Transmit data. In HP-SIR mode this pin is the UART output encoded for the serial infrared link. Otherwise it is the transmit output of the 16550 UART.
Rx	58	I	UART Receive data. In HP-SIR mode this pin is routed through the serial infrared decoder. Otherwise, it is the receive input to the 16550.
UCLK	59	O	<b>U</b> art <b>C</b> lock. Output of programmable rate UART/MODEM clock. Typically used for the Infrared Modulator.

**TABLE 2-13. PCMCIA Pins**

Symbol	Pins	Type	Function
CD_RST	68	O	<b>CarD ReSeT</b> . This active high signal resets the PCMCIA card during a soft-reset.
$\overline{\text{IOIS16}}/\text{WP}$	67	I	<b>IO port IS 16 bits/Write Protect</b> : When a PCMCIA card is configured as an IO card, this signal is asserted to indicate the currently addressed IO port is 16 bits wide. When a PCMCIA card is configured as a memory card, an active high signal indicates the card is currently write protected.
BVD2/SPKR	74	I	<b>Battery Voltage Detect bit 2/ SPeakeR</b> output. When a PCMCIA card is configured as a memory card, this input along with BVD[1] will provide status information about the card's on-board battery condition. When a PCMCIA card is configured as an IO card, this pin will act as the audio output of the card to the system.
BVD1/ $\overline{\text{STSCNG}}$	73	I	<b>Battery Voltage Detect bit 1/ STatus ChaNGe</b> output. When a PCMCIA card is configured as a memory card, this input along with BVD[2] will provide status information about the card's on-board battery state. When a PCMCIA card is configured as an I/O card, the status change signal indicates one or more of the memory status signals (BVD[2:1], WP, RDY or BSY) has changed states.
$\overline{\text{VCC}}\text{---SEL}$	69	O	PCMCIA <b>V<sub>CC</sub> SE</b> lect. When this signal is low, the V <sub>CC</sub> power to the PCMCIA card should be enabled.
V <sub>PP</sub> ---SEL1, V <sub>PP</sub> ---SEL2	70, 71	O	PCMCIA <b>V<sub>PP</sub> SE</b> lect 1 and 2. These signals indicate the voltage with which the V <sub>PP</sub> power to the PCMCIA card should be driven.
$\overline{\text{GPI}}$	72	I	<b>General Purpose Input</b> . This signal is a general purpose input signal used with a PCMCIA card to indicate a valid V <sub>PP</sub> state, a pending card eject/insertion, or as an interrupt source.
$\overline{\text{CD2}}, \overline{\text{CD1}}$	76, 75	I	<b>Card Detect</b> . Both signals are low when the PCMCIA card is correctly inserted.
DIR	77	O	<b>DIR</b> ection. Used to control the direction of the data line buffers to the PCMCIA interface.
$\overline{\text{ENABLE}}$	78	O	<b>ENABLE</b> PCMCIA. Enables the buffer drivers to the PCMCIA interface. Low true signal.
REG	79	O	<b>REG</b> . PCMCIA card support.

**Note:** If PCMCIA is enabled, Chip Selects 1 and 2 become Card Enable 1 and 2. See Table 2-17, "General Purpose Chip Select Pins". Also, IRQ[5] becomes the PCMCIA IREQ signal.

## 2.0 Pin Description Tables (Continued)

**TABLE 2-14. IEEE-1284 Port (ECP Mode)**

Symbol	Pins	Type	Function
PD[7:0]	81, 82, 83, 85, 86, 88, 89, 90	O/I	<b>Parallel Data.</b> Bi-directional data pins transfer data and address information to and from the parallel port.
$\overline{\text{SLIN}}$	91	O/I	<b>SeLect INput.</b> Used in a closed-loop handshake with $\overline{\text{BUSY}}$ to transfer data or address information from the host to the peripheral. Host driven.
$\overline{\text{STB}}$	92	O/I	<b>data STroBe.</b> Driven high by the host while in ECP Mode. Asserted low by host to terminate ECP Mode and return link to Compatibility Mode. Host driven.
$\overline{\text{AFD}}$	93	O/I	<b>Automatic FeeD.</b> The host asserts this line low for flow control in the reverse direction. It is used in a interlocked handshake with $\overline{\text{ACK}}$ . Provides command information in the forward direction. Host driven. Active low.
$\overline{\text{INIT}}$	94	O/I	<b>INITialize.</b> When this signal is asserted low to place the data channel in the reverse direction, the peripheral is allowed to drive the data bus. Host driven. Active low.
$\overline{\text{ACK}}$	95	I/O	<b>ACKnowledge.</b> Used in closed-loop handshake with $\overline{\text{AFD}}$ to transfer data to the host. Peripheral device drive. Active low.
$\overline{\text{PE}}$	96	I/O	<b>Peripheral Error.</b> Asserted low to acknowledge $\overline{\text{INIT}}$ , reverse request. Peripheral device drive.
SLCT	97	I/O	<b>SeLeCT.</b> Asserted high when selected or indicating an affirmative response for each respective extensibility byte. Peripheral device drive. Active high.
$\overline{\text{ERR}}$	99	I/O	<b>ERROR.</b> This input is asserted low by the peripheral to request host communications. Valid only in the forward direction. Peripheral device drive. Active low.
BUSY	100	I/O	<b>BUSY.</b> This is asserted low by the peripheral for flow control in the forward direction, de-asserted to acknowledge transfer of data or address completion. Peripheral device drive. Active low.

**TABLE 2-15. Timer Pins**

Symbol	Pins	Type	Function
T0	55	I/O	Programmable <b>Timer pin 0.</b> This Bidirectional pin may be selected to control one of the following four functions via bits 1-0 of the Timer I/O Control Register: <ol style="list-style-type: none"> <li>1. The GATE input into Timer 0.</li> <li>2. The GATE input into Timer 1.</li> <li>3. The OUT output from Timer 0.</li> <li>4. The CLK input into Timer 1.</li> </ol>
T1	56	I/O	Programmable <b>Timer pin 1.</b> This Bidirectional pin may be selected to control one of the following four functions via bits 3-2 of the Timer I/O Control Register: <ol style="list-style-type: none"> <li>1. The GATE input into Timer 0.</li> <li>2. The GATE input into Timer 1.</li> <li>3. The OUT output from Timer 1.</li> <li>4. The CLK input into Timer 0.</li> </ol>



## 2.0 Pin Description Tables (Continued)

TABLE 2-16. 3-Wire Serial I/O Pins

Symbol	Pins	Type	Function
SO/ $\overline{\text{DCD}}$	41	I/O	<p>This pin has two possible programmable options controlled by the Modem Signal Control Register (refer to the UART section):</p> <ol style="list-style-type: none"> <li>1. The <b>Serial data Output</b> signal for MICROWIRE.</li> <li>2. <b>Data Carrier Detect</b>. When low, this input signal indicates that the data carrier has been detected by the MODEM or data set. The <math>\overline{\text{DCD}}</math> signal is a MODEM status input whose condition can be tested by the CPU reading bit 7 (DCD) of the MODEM Status Register. Bit 7 is the complement of the <math>\overline{\text{DCD}}</math> signal. Bit 3 (DDCD) of the MODEM Status Register indicates whether the <math>\overline{\text{DCD}}</math> input has changed state since the previous reading of the MODEM Status Register. DCD has no effect on the receiver.</li> </ol> <p><b>Note:</b> Whenever the DCD bit of the MODEM Status Register changes state, an interrupt is generated if the MODEM Status Interrupt is enabled.</p>
SI/ $\overline{\text{CTS}}$	42	I/O	<p>This pin has two possible programmable options controlled by the Modem Signal Control Register (refer to the UART section):</p> <ol style="list-style-type: none"> <li>1. The <b>Serial data Input</b> signal for MICROWIRE or the serial data I/O for Access.bus.</li> <li>2. <b>Clear To Send</b>. When low, this input signal indicates that the MODEM or data set is ready to exchange data. The <math>\overline{\text{CTS}}</math> signal is a MODEM status input whose conditions can be tested by the CPU reading bit 4 (CTS) of the MODEM Status Register. Bit 4 is the complement of the <math>\overline{\text{CTS}}</math> signal. Bit 0 (DCTS) of the MODEM Status Register indicates whether the <math>\overline{\text{CTS}}</math> input has changed state since the previous reading of the MODEM Status Register. <math>\overline{\text{CTS}}</math> has no effect on the Transmitter.</li> </ol> <p><b>Note:</b> Whenever the CTS bit of the MODEM Status Register changes state, an interrupt is generated if the MODEM Status Interrupt is enabled.</p>
SCLK/ $\overline{\text{RI}}$	43	I/O O I	<p>This pin has two possible programmable options controlled by the Modem Signal Control Register (refer to the UART section):</p> <ol style="list-style-type: none"> <li>1. The <b>Serial CLocK</b> signal for MICROWIRE and Access.bus.</li> <li>2. <b>Ring Indicator</b>. When low, this input signal indicates that a telephone ringing signal has been received by the MODEM or data set. The <math>\overline{\text{RI}}</math> signal is a MODEM status input whose condition can be tested by the CPU reading bit 6 (RI) of the MODEM Status Register. Bit 6 is the complement of the <math>\overline{\text{RI}}</math> signal. Bit 2 (TERI) of the MODEM Status Register indicates whether the <math>\overline{\text{RI}}</math> input <b>signal</b> has changed from a low to high state since the previous reading of the MODEM Status Register.</li> </ol> <p><b>Note:</b> Whenever the CTS bit of the MODEM Status Register changes state, an interrupt is generated if the MODEM Status Interrupt is enabled.</p> <p><b>Note:</b> Whenever the <b>RI</b> bit of the MODEM Status Register changes from a high to a low state, an interrupt is generated if the MODEM Status Interrupt is enabled.</p>

**Note:** For MICROWIRE Slave Mode, a pin must be selected to be the Chip Select Input.

## 2.0 Pin Description Tables (Continued)

**TABLE 2-17. General Purpose Chip Select Pins**

Symbol	Pins	Type	Function
$\overline{CS}[0]$	118	O	<b>Chip Select 0:</b> This output is used as the chip-select for the system boot ROM. It defaults to the upper 64 kbytes of memory.
$\overline{CS}[5:1]$	113, 114, 115, 116, 117	I/O	<b>Chip Select 1-5.</b> These pins can be programmed to be either memory or I/O mapped chip selects, which are used for glue-less connection to external peripherals. When the PCMCIA Controller is enabled $\overline{CS}[1]$ and $\overline{CS}[2]$ become PCMCIA Card Enable outputs 1 and 2 ( $\overline{CE}1$ and $\overline{CE}2$ , respectively).

**TABLE 2-18. Summary of Reconfigurable I/O Pins**

Symbol	Pins	Type	Pin #	Original Function	Power Up State
$\overline{REG}$	1	I/O	79	PCMCIA	TRI-STATE
ENABLE	1	I/O	78	PCMCIA	1
DIR	1	I/O	77	PCMCIA	0
$\overline{GPI}$	1	I/O	72	PCMCIA	TRI-STATE
$V_{pp\_SEL2}$	1	I/O	71	PCMCIA	0
$V_{pp\_SEL1}$	1	I/O	70	PCMCIA	0
$V_{CC\_SEL}$	1	I/O	69	PCMCIA	1
$CD\_RST$	1	I/O	68	PCMCIA	TRI-STATE
CLF	1	I/O	48	LCD	0
CL2	1	I/O	50	LCD	0
CL1	1	I/O	49	LCD	0
LCD [3:0]	4	I/O	51, 52, 53, 54	LCD	0, 0, 0, 0
PD [7:0]	8	I/O	81, 82, 83, 85, 86, 88, 89, 90	ECP	TRI-STATE
Rx	1	I/O	58	UART	TRI-STATE
UCLK	1	I/O	59	UART	Oscillating
$\overline{CS}[4]$	1	I/O	114	CS4	1
$\overline{CS}[3]$	1	I/O	115	CS3	1
$\overline{CS}[2]$	1	I/O	116	CS2	1
$\overline{CS}[1]$	1	I/O	117	CS1	1

These 29 pins, typically used for various I/O peripheral purposes, as defined in the above tables, can be reconfigured for use as general purpose I/O pins if the normally defined I/O function is not required.

### 3.0 Device Specifications

#### 3.1 DC ELECTRICAL SPECIFICATIONS 5V ± 5%

##### 3.1.1 Recommended Operating Conditions

Symbol	Parameter	Condition	Min	Typ	Max	Units
V <sub>DD</sub>	Supply Voltage		4.75	5.0	5.25	V
T <sub>A</sub>	Operating Temperature		0		+70	°C
	ESD Tolerance	C <sub>ZAP</sub> = 100 pF R <sub>ZAP</sub> = 1.5 kΩ (Note 1)	2000			V

##### 3.1.2 Absolute Maximum Ratings (Notes 2 and 3)

Symbol	Parameter	Condition	Min	Max	Units
V <sub>DD</sub> , V <sub>DDA</sub>	Supply Voltage		-0.5	7.0	V
V <sub>I</sub>	Input Voltage		-0.5	V <sub>DD</sub> + 0.5	V
V <sub>O</sub>	Output Voltage		-0.5	V <sub>DD</sub> + 0.5	V
T <sub>STG</sub>	Storage Temperature		-65	+165	°C
T <sub>L</sub>	Lead Temperature Soldering (10 sec.)			+260	°C

##### 3.1.3 Capacitance: T<sub>A</sub> = 25°C, f = 1 MHz

Symbol	Parameter	Condition	Min	Typ	Max	Units
C <sub>IN</sub>	Input Pin Capacitance			5	7	pF
C <sub>IN1</sub>	Clock Input Capacitance			8	10	pF
C <sub>IO</sub>	I/O Pin Capacitance			10	12	pF
C <sub>O</sub>	Output Pin Capacitance			6	8	pF

### 3.0 Device Specifications (Continued)

#### 3.1.4 DC Characteristics (Under Recommended Operating Conditions)

Symbol	Parameter	Condition	Min	Typ	Max	Units
V <sub>IH</sub>	Input High Voltage		2.0		V <sub>DD</sub>	V
V <sub>IL</sub>	Input Low Voltage		-0.5		0.8	V
I <sub>CC</sub>	V <sub>DD</sub> Average Supply Current	V <sub>IL</sub> = 0.5V V <sub>IH</sub> = 2.4V No Load				mA

**Note 1:** Value based on test complying with NSC SOP5-028 human body model ESD testing using the ETS-910 tester.

**Note 2:** Absolute Maximum Ratings are those values beyond which damage to the device may occur.

**Note 3:** Unless otherwise specified all voltages are referenced to ground.

#### 3.1.4.1 EXTERNAL BUS

Symbol	Parameter	Condition	Min	Max	Units	Notes
V <sub>OH</sub>	Output High Voltage	I <sub>OH</sub> = -6 mA (Nch Quiet-drive) or I <sub>OH</sub> = -24 mA (High-drive) on: SA12-1, DP1-0, SD15-0 I <sub>OH</sub> = -12 mA on: SA0, SA25-13 [SA0 - min. 10 kΩ pullup]	2.4		V	Max Load on SA12-1 is 100 pF, and SD0-15 is 50 pF
V <sub>OL</sub>	Output Low Voltage	I <sub>OL</sub> = 20 mA on: SA12-1, DP1-0, SD15-0 I <sub>OL</sub> = 12 mA on: SA0, SA25-13, BHE		0.4	V	

#### 3.1.4.2 DMA CONTROL UNIT

Symbol	Parameter	Condition	Min	Max	Units	Notes
V <sub>OH</sub>	Output High Voltage	I <sub>OH</sub> = -6 mA on: TC/EOP I <sub>OH</sub> = -4 mA on: DACK4, DACK3, DACK2, DACK0	2.4		V	
V <sub>OL</sub>	Output Low Voltage	I <sub>OL</sub> = 6 mA on: TC/EOP I <sub>OL</sub> = 4 mA on: DACK4, DACK3, DACK2, DACK0		0.4	V	

#### 3.1.4.3 DRAM CONTROL UNIT

Symbol	Parameter	Condition	Min	Max	Units	Notes
V <sub>OH</sub>	Output High Voltage	I <sub>OH</sub> = -6 mA (Nch Quiet-drive) or I <sub>OH</sub> = -24 mA (High-drive) on: RAS0-1, CASH0-1, CASL0-1, WE	2.4		V	Max load on RAS1-0, CASH1-0, and CASL1-0 is 63 pF
V <sub>OL</sub>	Output Low Voltage	I <sub>OL</sub> = 20 mA on: RAS1-0, CASH1-0, CASL1-0, WE		0.4	V	Max load on WE is 100 pF

### 3.0 Device Specifications (Continued)

#### 3.1.4.4 AUXILIARY PROCESSOR INTERFACE

Symbol	Parameter	Condition	Min	Max	Unit	Notes
V <sub>OH</sub>	Output High Voltage	I <sub>OH</sub> = -6 mA on: $\overline{EACK}$ I <sub>OH</sub> = -4 mA on: $\overline{DRV}$ , $\overline{EREQ}$	2.4		V	
V <sub>OL</sub>	Output Low Voltage	I <sub>OL</sub> = 6 mA on: $\overline{EACK}$ I <sub>OL</sub> = 4 mA on: $\overline{DRV}$ , $\overline{EREQ}$		0.4	V	

#### 3.1.4.5 HP-SIR/UART

Symbol	Parameter	Condition	Min	Max	Unit	Notes
V <sub>OH</sub>	Output High Voltage	I <sub>OH</sub> = -100 $\mu$ A I <sub>OH</sub> = -6 mA on: Tx, UCLK, Rx	V <sub>CC</sub> - 0.2 2.4		V V	
V <sub>OL</sub>	Output Low Voltage	I <sub>OL</sub> = 100 $\mu$ A I <sub>OL</sub> = 6 mA on: Tx, UCLK, Rx		0.2 0.4	V V	

#### 3.1.4.6 EXTERNAL BUS CONTROL

Symbol	Parameter	Condition	Min	Max	Unit	Notes
V <sub>OH</sub>	Output High Voltage	I <sub>OH</sub> = -12 mA on: $\overline{IOR}$ , $\overline{IOW}$ , $\overline{MEMR}$ , $\overline{MEMW}$ , $\overline{RESET}$ , $\overline{RESET}$ , CS16, $\overline{BHE}$ [CS16 - min. 10 k $\Omega$ pullup]	2.4		V	
V <sub>OL</sub>	Output Low Voltage	I <sub>OL</sub> = 12 mA on: $\overline{IOR}$ , $\overline{IOW}$ , $\overline{MEMR}$ , $\overline{MEMW}$ , $\overline{RESET}$ , $\overline{RESET}$ , CS16, $\overline{BHE}$		0.4	V	

#### 3.1.4.7 OSCILLATOR (CPUX1/CLK)

Symbol	Parameter	Condition	Min	Max	Unit	Notes
V <sub>OH</sub>	Output High Voltage	I <sub>OH</sub> = -12 mA on: SYSCLK	2.4		V	
V <sub>OL</sub>	Output Low Voltage	I <sub>OL</sub> = 12 mA on: SYSCLK		0.4	V	
V <sub>IH</sub>	OSCX1 Input High Voltage		2.4			OSCX2 is the output
V <sub>IL</sub>	OSCX2 Input Low Voltage			0.4	V	

#### 3.1.4.8 LCD INTERFACE

Symbol	Parameter	Condition	Min	Max	Unit	Notes
V <sub>OH</sub>	Output High Voltage	I <sub>OH</sub> = -2.6 mA on: LCD[3:0], CL1, CL2, CLF	V <sub>CC</sub> - 0.8		V	CMOS Level
V <sub>OH</sub>	Output High Voltage	I <sub>OH</sub> = -6 mA on: LCD[3:0], CL1, CL2, CLF	2.4		V	TTI Level
V <sub>OL</sub>	Output Low Voltage	I <sub>OL</sub> = 6 mA on: LCD[3:0], CL1, CL2, CLF		0.4	V	

### 3.0 Device Specifications (Continued)

#### 3.1.4.9 REAL TIME CLOCK (RTCX1/CLK)

Symbol	Parameter	Condition	Min	Max	Unit	Notes
V <sub>IH</sub>	RTCX1 Input High Voltage		2.0			RTCX2 is the output
V <sub>IL</sub>	RTCX1 Input Low Voltage			0.4	V	
V <sub>BAT</sub>	Battery Voltage		2.4		V	Lithium Battery
I <sub>BAT</sub>	Battery Current	V <sub>BAT</sub> = 3.0 V		3	μA	

#### 3.1.4.10 PCMCIA (RIO8-15)

Symbol	Parameter	Condition	Min	Max	Unit	Notes
V <sub>OH</sub>	Output High Voltage	I <sub>OH</sub> = -12 mA on: V <sub>CC_SEL</sub> , V <sub>PP_SEL1</sub> , V <sub>PP_SEL2</sub> I <sub>OH</sub> = -6 mA on: DIR, ENABLE, $\overline{\text{REG}}$ , CD_RST, BUSY_LED, $\overline{\text{GPI}}$ , RSV (RSV is a reserved usage pin)	2.4		V	Power Switch 1 Card at a 50 pF Load
V <sub>OL</sub>	Output Low Voltage	I <sub>OL</sub> = 12 mA on: V <sub>CC_SEL</sub> , V <sub>PP_SEL</sub> , V <sub>PP_SEL2</sub> I <sub>OL</sub> = 6 mA on: DIR, ENABLE, $\overline{\text{REG}}$ , CD_RST, BUSY_LED, $\overline{\text{GPI}}$ , RSV (RSV is a reserved usage pin)		0.4	V	

#### 3.1.4.11 IEEE-1284 PORT (ECP MODE) AND (RIO16-31)

Symbol	Parameter	Condition	Min	Max	Unit	Notes
I <sub>CH</sub>	High-Level Output Current (Note 4)	V <sub>OH</sub> = 2.4V on: PD[7:0], SLIN, STB, AFD, PE, INIT, ACK, SLCT_ERR, BUSY	14		mA	
I <sub>CL</sub>	Low-Level Output Current	V <sub>OL</sub> = 0.4V on: PD[7:0], SLIN, STB, AFD, PE, INIT, ACK, SLCT_ERR, BUSY	14		mA	

**Note 4:** When ECP mode 0, or ECP mode 2 and bit 1 of PCR is 0 for the parallel port, are selected, pins AFD, INIT, SLIN, and STB are open drain supports. 4.7 kΩ resistors should be used. The ECP I/Os have over-voltage protection against being backdriven by higher external voltages when the I/Os are at TRI-STATE. The I/Os also isolate the NS486SXF power-rail from external voltages when the chip is powered down. The maximum power-down leakage is 1 mA to ground.

#### 3.1.4.12 TIMER

Symbol	Parameter	Condition	Min	Max	Unit	Notes
V <sub>OH</sub>	Output High Voltage	I <sub>OH</sub> = -6 mA on: T0, T1	2.4		V	
V <sub>OL</sub>	Output Low Voltage	I <sub>OL</sub> = 6 mA on: T0, T1		0.4	V	

### 3.0 Device Specifications (Continued)

#### 3.1.4.13 GENERAL PURPOSE CHIP SELECTS

Symbol	Parameter	Condition	Min	Max	Unit	Notes
V <sub>OH</sub>	Output High Voltage	I <sub>OH</sub> = -6 mA on: $\overline{CS5-0}$	2.4		V	
V <sub>OL</sub>	Output Low Voltage	I <sub>OL</sub> = 6 mA on: $\overline{CS5-0}$		0.4	V	

#### 3.1.4.14 INTERRUPT CONTROLLER

Symbol	Parameter	Condition	Min	Max	Unit	Notes
V <sub>OH</sub>	Output High Voltage	I <sub>OH</sub> = -12 mA on: $\overline{INTA}$	2.4		V	
V <sub>OL</sub>	Output Low Voltage	I <sub>OL</sub> = 12 mA on: $\overline{INTA}$		0.4	V	

#### 3.1.4.15 3-WIRE I/O (AND ACCESS.BUS)

Symbol	Parameter	Condition	Min	Max	Unit	Notes
V <sub>OH</sub>	Output High Voltage	I <sub>OH</sub> = -12 mA on: SO, SI, SCLK	2.4		V	
V <sub>OL</sub>	Output Low Voltage	I <sub>OL</sub> = 12 mA on: SO, SI, SCLK		0.4	V	

### 3.0 Device Specifications (Continued)

#### 3.2 GENERAL AC SPECIFICATIONS

##### AC TEST CONDITIONS

**Note 1:**  $S_1 = V_{CC}$  for  $t_{pZL}$  and  $t_{pLZ}$  measurements  
 $S_1 = \text{GND}$  for  $t_{pZL}$  and  $t_{pHZ}$  measurements  
 $S_1 = \text{Open}$  for push-pull outputs

**Note 2:**  $R_L = 1.1k$

**Note 3:**  $C_L$  includes scope and jig capacitance

#### Test Circuit for Output Tests

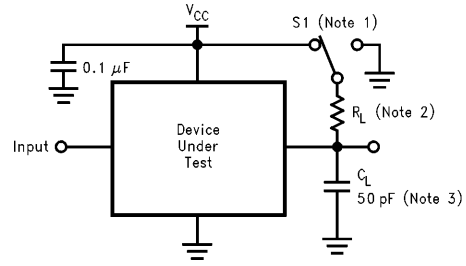

TL/H/12514-5

#### Propagation Delay Waveforms

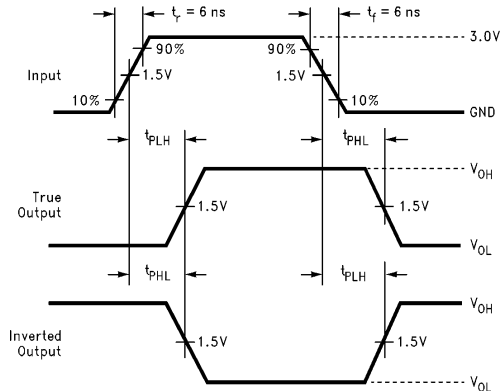

TL/H/12514-6

#### Setup and Hold Time Waveforms

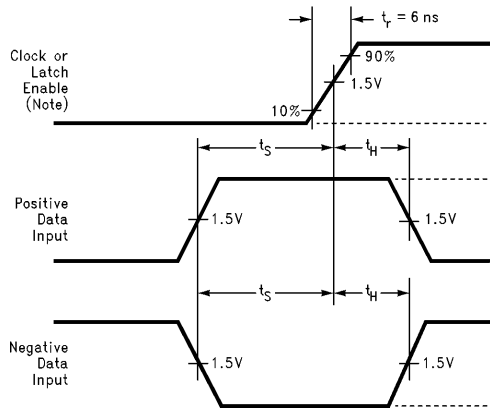

TL/H/12514-7

**Note:** Waveform for negative edge sensitive circuits will be invert.

#### Input Pulse Width Waveforms Except for Clock Pins

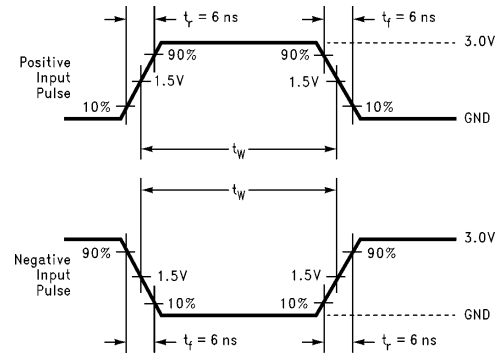

TL/H/12514-8

#### TRI-STATE Output Enable and Disable Waveforms

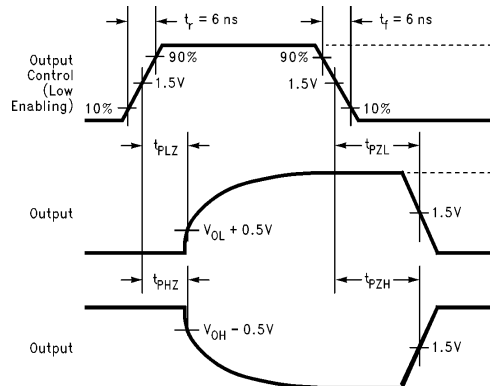

TL/H/12514-9

FIGURE 3-1. Switching Characteristic Measurement Waveforms



### 3.0 Device Specifications (Continued)

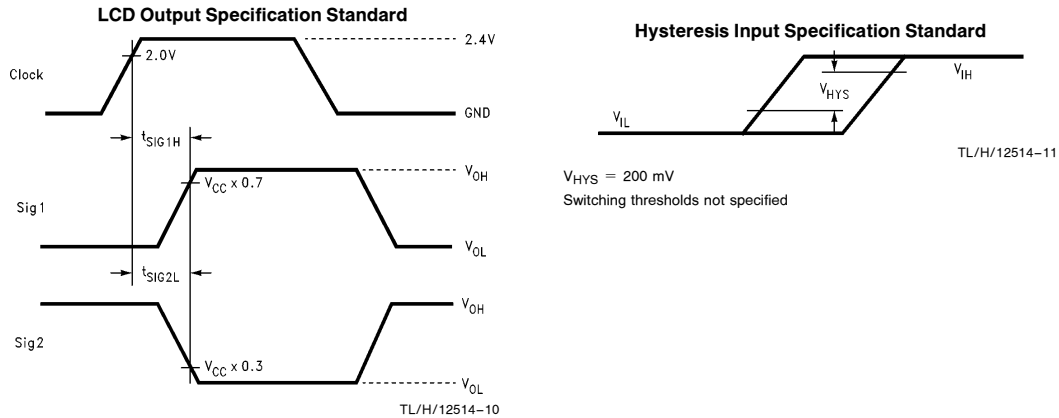

FIGURE 3-2. More Switching Specifications

#### 3.2.1 Power Ramp Times

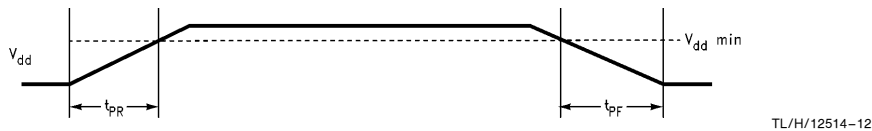

FIGURE 3-3. Power Supply Rise and Fall

TABLE 3-1. V<sub>DD</sub> Rise and Fall Times

Symbol	Parameter	Min	Max	Unit
t <sub>PF</sub>	V <sub>DD</sub> Falling Time from 4.5V to 0V	5		ms
t <sub>PR</sub>	V <sub>DD</sub> Rising Time from 0V to 4.5V	5		ms

Note: The rising/falling rate is assumed linear.

#### 3.2.2 PWRGOOD and Power Rampdown Timing

TABLE 3-2. V<sub>DD</sub> Rampdown vs PWRGOOD

Symbol	Parameter	Min	Max	Unit
t <sub>VPG</sub>	V <sub>DD</sub> (4.5V) to PWRGOOD High	1		μs
t <sub>PGV</sub>	PWRGOOD Falling to V <sub>DD</sub> (4.5V)	1		μs

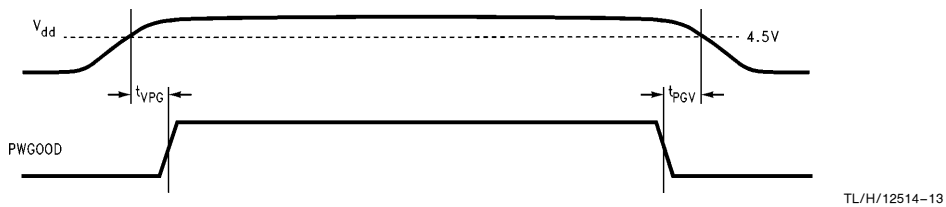

Note: The rising/falling rate is assumed linear.

FIGURE 3-4. PWRGOOD in Relation to V<sub>DD</sub>

### 3.0 Device Specifications (Continued)

#### 3.3 AC SWITCHING SPECIFICATIONS

The following pages list some of the preliminary AC Specifications for the NS486SXF. All parameters are listed in alphabetical order according to their Symbol.

#### The Tables consist of the following:

- Parameter — A short description of the specification being documented.
- Symbol — A quick reference between the timing diagram and the Table entries.
- Formula — An equation, which in addition to the Minimum and Maximum Specifications can be used to determine the actual timing provided at any operating frequency.
- Min. — Minimum Specification when added to the value produced by the formula.
- Max. — Maximum Specification when added to the value produced by the formula.

#### How to calculate the actual specification at a given frequency:

In the formula column, one will see many formulae, which contain the variable T. The T represents one period (or one T-state) of the CPU Clock. So if the CPU is running at 25 MHz, T is equivalent to 40 ns; similarly if the CPU is running at 20 MHz, T is equivalent to 50 ns.

EXAMPLE: Calculate the minimum guaranteed Column Address Setup Time

$$\begin{aligned} \text{At 25 MHz: Formula + Min. Spec.} &= \\ (0.5T) + (-20 \text{ ns}) &= \\ 0.5 (40 \text{ ns}) + (-20 \text{ ns}) &= \\ 20 \text{ ns} - 20 \text{ ns} &= 0 \text{ ns} \\ \\ \text{At 20 MHz: Formula + Min. Spec.} &= \\ (0.5T) + (-20 \text{ ns}) &= \\ 0.5 (50 \text{ ns}) + (-20 \text{ ns}) &= \\ 25 \text{ ns} - 20 \text{ ns} &= 5 \text{ ns} \end{aligned}$$

As the frequency varies, so will many of the specifications. One should always calculate the specification based on the CPU's operating frequency.

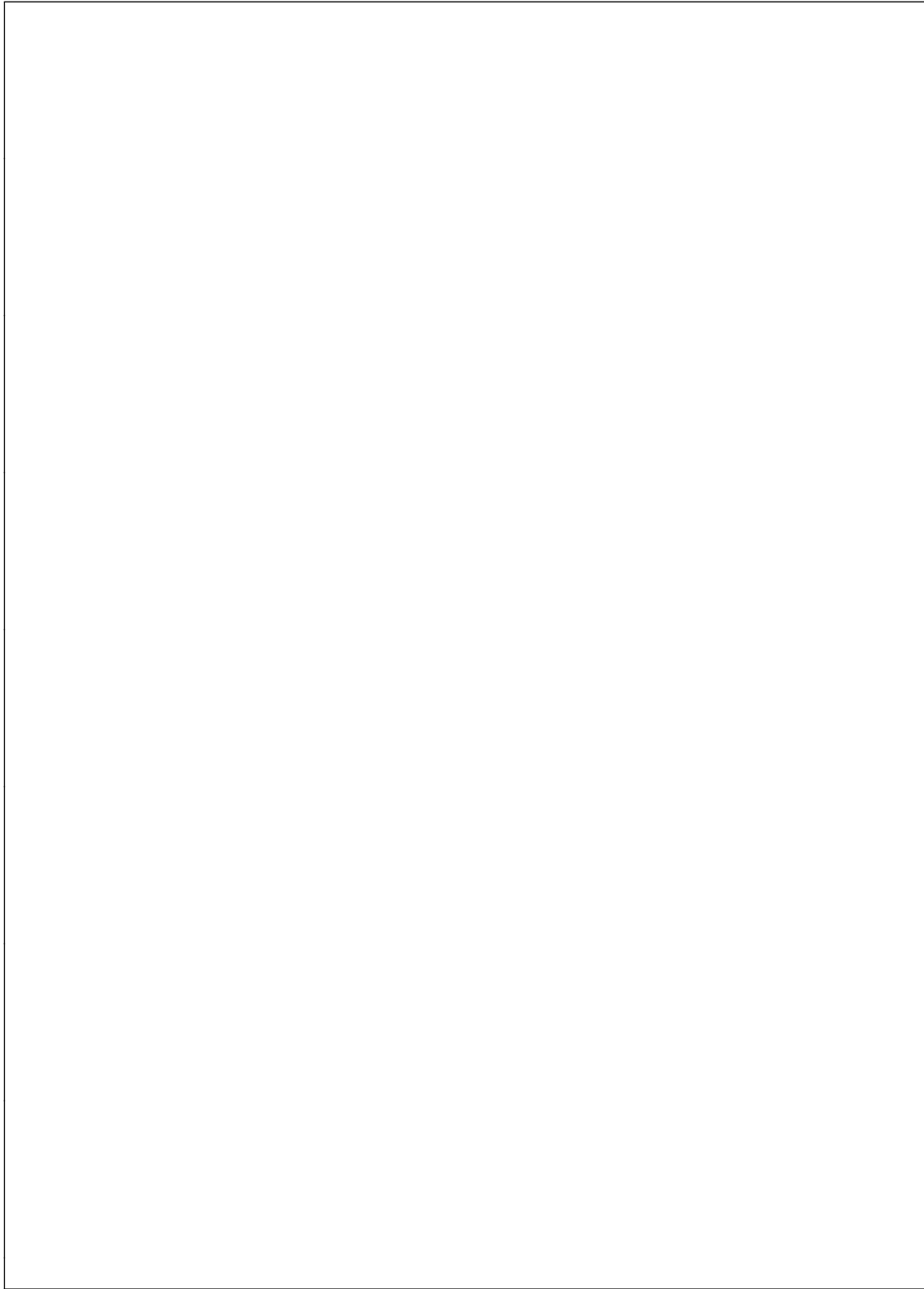

### 3.0 Device Specifications (Continued)

#### 3.3.1 DRAM Interface Timing Specification

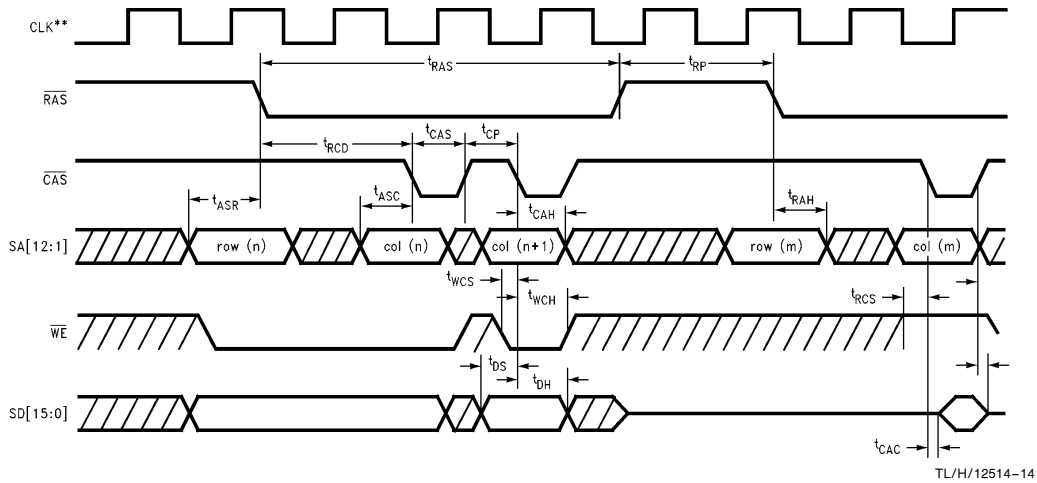

\*\*The CLK signal is only included as a reference; no specifications are guaranteed to this signal.

FIGURE 3-5. DRAM Timing Diagram

TABLE 3-3. 4-Cycle Page Miss Preliminary Specifications

Symbol	Parameter	Formula	Min	Max
$t_{ASC}$	Column Address Setup Time	$0.5T +$	-20	
$t_{ASR}$	Row Address Setup Time	$0.5T +$	-20	
$t_{CAC}$	Access Time from CAS	$0.5T +$		-5
$t_{CAH}$	Column Address Hold Time	$0.5T +$	-5	
$t_{CAS}$	$\overline{CAS}$ Pulse Width	$0.5T +$	0	10
$t_{CP}$	Page Mode $\overline{CAS}$ Precharge	$0.5T +$	-10	
$t_{DH}$	Write Data Hold Time	$0.5T +$	-5	
$t_{DS}$	Write Data Setup Time	$0.5T +$	-20	
$t_{OFF}$	Read Data Valid Hold Time		0	
$t_{RAS}$	$\overline{RAS}$ Pulse Width	$2.5T +$	-15	Programmable
$t_{RAH}$	Row Address Hold Time	$0.5T +$	-10	
$t_{RCD}$	$\overline{RAS}$ to $\overline{CAS}$ Delay Time	$1.5T +$	-20	
$t_{RCH}$	Read Command Hold Time		0	
$t_{RCS}$	Read Command Setup Time	$0.5T +$	-20	
$t_{RP}$	$\overline{RAS}$ Precharge Time	$1.5T +$	-10	
$t_{WCH}$	Write Command Hold Time	$0.5T +$	-5	
$t_{WCS}$	Write Command Setup Time	$0.5T +$	-20	

### 3.0 Device Specifications (Continued)

TABLE 3-4. 3 Cycle Miss Preliminary Specifications

Symbol	Parameter	Formula	Min	Max
$t_{ASC}$	Column Address Setup Time	$0.5T +$	-20	
$t_{ASR}$	Row Address Setup Time	$0.5T +$	-20	
$t_{CAC}$	Access Time From $\overline{CAS}$	$0.5T +$		-5
$t_{CAH}$	Column Address Hold Time	$0.5T +$	-5	
$t_{CAS}$	$\overline{CAS}$ Pulse Width	$0.5T +$	0	10
$t_{CP}$	Page Mode $\overline{CAS}$ Precharge	$0.5T +$	-10	
$t_{DH}$	Write Data Hold Time	$0.5T +$	-5	
$t_{DS}$	Write Data Setup Time	$0.5T +$	-20	
$t_{OFF}$	Read Data Valid Hold Time		0	
$t_{RAS}$	$\overline{RAS}$ Pulse Width	$2.0T +$	-15	PROG
$t_{RAH}$	Row Address Hold Time	$0.5T +$	-10	
$t_{RCD}$	$\overline{RAS}$ to $\overline{CAS}$ Delay Time	$1.0T +$	-20	
$t_{RCH}$	Read Command Hold Time		0	
$t_{RCS}$	Read Command Setup Time	$0.5T +$	-20	
$t_{RP}$	$\overline{RAS}$ Precharge Time	$1.0T +$	0	
$t_{WCH}$	Write Command Hold Time	$0.5T +$	-5	
$t_{WCS}$	Write Command Setup Time	$0.5T +$	-20	

#### 3.3.2 ISA-like Bus Cycles Timing Specification

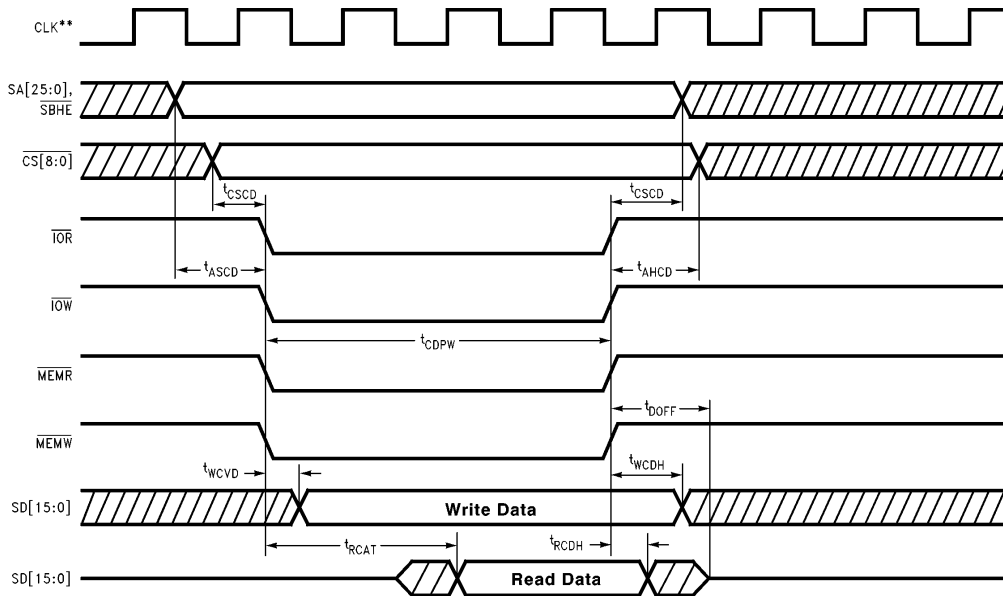

TL/H/12514-15

\*\*The CLK signal is only included as a reference; no specifications are guaranteed to this signal.

FIGURE 3-6. ISA-like Bus Timing Diagram

### 3.0 Device Specifications (Continued)

**TABLE 3-5. No Command Delay ISA-like Bus Specifications**

Symbol	Parameter	Formula	Min	Max
$t_{AHCD}$	Address Hold Time from $\overline{CMD}$	$1.0T +$	-20	
$t_{ASCD}$	Address Setup Time to $\overline{CMD}$	$1.0T +$	-20	
$t_{CDPW}$	Command Pulse Width	$1.0T + (Wait)T +$	-10	
$t_{CHCD}$	Chip Select Hold Time from $\overline{CMD}$	$1.0T +$	-25	
$t_{CSCD}$	Chip Select Setup Time to $\overline{CMD}$	$1.0T +$	-40	
$t_{DOFF}$	Read Data TRI-STATE	$1.0T +$		-25
$t_{RCAT}$	Read $\overline{CMD}$ Data Access Time	$1.0T + (Wait)T +$		-30
$t_{RCDH}$	Read $\overline{CMD}$ Data Hold Time		0	
$t_{WCDH}$	Write $\overline{CMD}$ Data Hold Time	$1.0T +$	-25	
$t_{WCVD}$	Write $\overline{CMD}$ to Valid Data			5
$t_{WCS}$	Write Command Setup Time	$0.5T +$	-20	

**Note:** The value of (Wait) in the above formulae, is the number of programmed wait states associated with that access cycle (default value is 7, but may be programmed to 0-7).

**TABLE 3-6. One Programmed Command Delay ISA-like Bus Specifications**

Symbol	Parameter	Formula	Min	Max
$t_{AHCD}$	Address Hold Time from $\overline{CMD}$	$1.0T +$	-20	
$t_{ASCD}$	Address Setup Time to $\overline{CMD}$	$2.0T +$	-20	
$t_{CDPW}$	Command Pulse Width	$1.0T + (Wait)T +$	-10	
$t_{CHCD}$	Chip Select Hold Time from $\overline{CMD}$	$1.0T +$	-25	
$t_{CSCD}$	Chip Select Setup Time to $\overline{CMD}$	$2.0T +$	-40	
$t_{DOFF}$	Read Data TRI-STATE	$1.0T +$		-25
$t_{RCAT}$	Read $\overline{CMD}$ Data Access Time	$1.0T + (Wait)T +$		-30
$t_{RCDH}$	Read $\overline{CMD}$ Data Hold Time		0	
$t_{WCDH}$	Write $\overline{CMD}$ Data Hold Time	$1.0T +$	-25	
$t_{WCVD}$	Write Valid Data to CMD (Note 2)	$1.0T +$	-5	
$t_{WCS}$	Write Command Setup Time	$0.5T +$	-20	

**Note 1:** The value of (Wait) in the above formulae, is the number of programmed wait states associated with that access cycle (default value is 7, but may be programmed to 0-7).

**Note 2:** For this case Valid Write Data Sets-up to the leading edge of the Command Strobe.

### 3.0 Device Specifications (Continued)

#### 3.3.3 Ready Feedback Timing Specifications

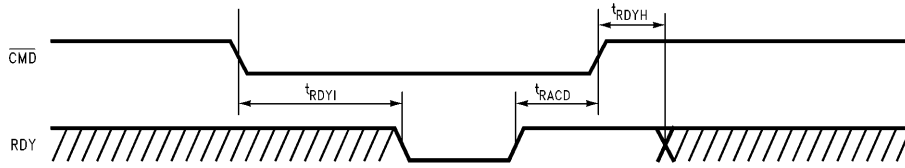

TL/H/12514-16

FIGURE 3-7. Ready Feedback Timing Diagram

TABLE 3-7. Ready Signal Timing Specifications

Symbol	Parameter	Formula	Min	Max
$t_{RACD}$	RDY Active to $\overline{CMD}$ Rising	$(E\_RDY)T +$	0	
$t_{RDYH}$	RDY Hold Time from $\overline{CMD}$		0	
$t_{RDYI}$	$\overline{CMD}$ to RDY Inactive Feedback	$1.0T + (Wait)T +$		-30

**Note:** The value of (Wait) in the above formulae, is the number of programmed wait states associated with that access cycle (default value is 7, but may be programmed to 0-7). The value of (E\_RDY) in the above formulae, is the number of programmed extended ready states associated with every access cycle (default number is 2, but may be programmed to 0-2).

#### 3.3.4 OSCX1 AC Specification

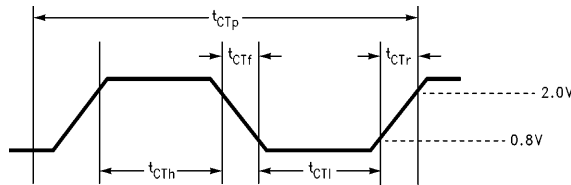

TL/H/12514-17

FIGURE 3-8. TTL Clock Input Timing Diagram

TABLE 3-8. TTL Clock Input Specification

Symbol	Parameter	Min	Max	Unit
$t_{CTP}$	CTTL Clock Period	40	870	ns
$t_{CTH}$	CTTL High Time (Note)	$(0.5 \times t_{CTP}) - 4$		ns
$t_{CTI}$	CTTL Low Time (Note)	$(0.5 \times t_{CTP}) - 4$		ns
$t_{CTr}$	CTTL Rise Time		4	ns
$t_{CTf}$	CTTL Fall Time		4	ns

**Note:** Except for the cycle in which the core frequency is changed. In this cycle,  $t_{CTH}$  and  $t_{CTI}$  relate to different  $t_{CTP}$  cycles.

### 3.0 Device Specifications (Continued)

#### 3.3.5 Peripheral Timing Specifications

##### 3.3.5.1 DMA CONTROLLER

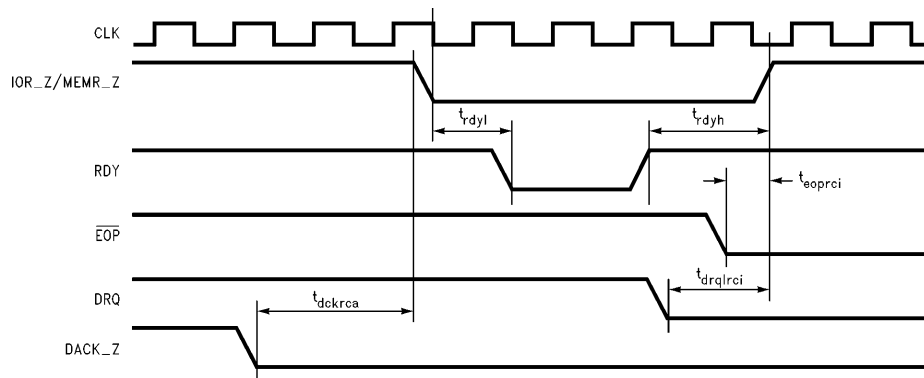

TL/H/12514-18

FIGURE 3-9. DMA Controller Read Timing Diagram

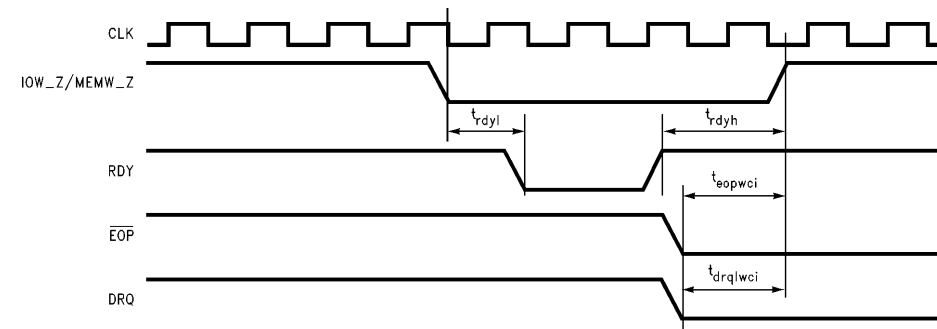

TL/H/12514-19

FIGURE 3-10. DMA Controller Write Timing Diagram

TABLE 3-9. DMA Controller Specifications

Symbol	Parameter	Min	Typ	Max
$t_{rdyl}$	RDY Inactive Low Setup to CMD Active	-15 ns		
$t_{rdyh}$	RDY Active High Setup to CMD Inactive			$2T + 15$ ns
$t_{eoprci}$		45 ns		
$t_{eopwci}$		$2T + 5$ ns		
$t_{drqlwci}$		$2T + 36$ ns		
$t_{drqlrci}$		$T + 40$ ns		
$t_{dckrca}$		$2T + 2.2$ ns		



### 3.0 Device Specifications (Continued)

#### 3.3.5.2 PIC AC SPECS

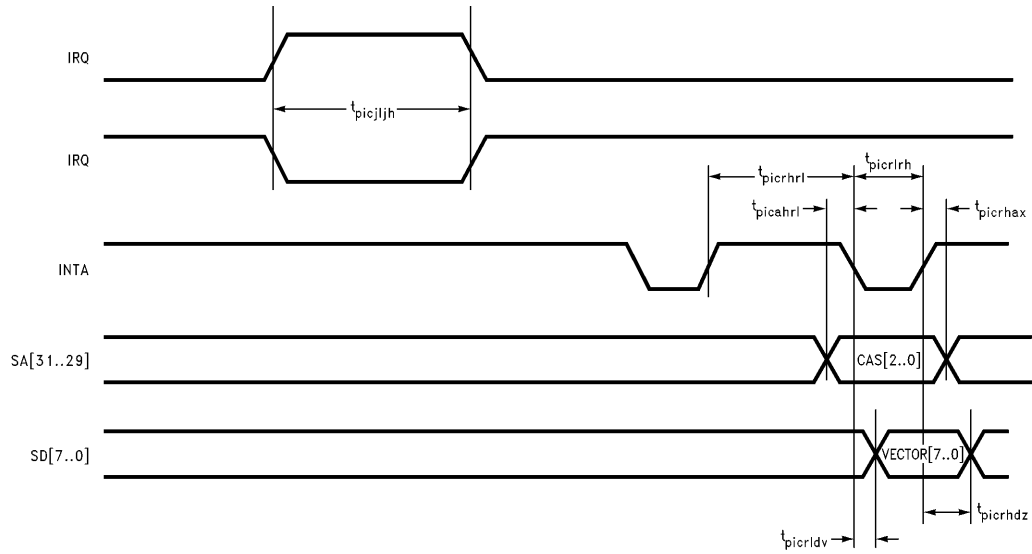

TL/H/12514-20

FIGURE 3-11. PIC Timing Diagram

TABLE 3-10. PIC Timing Specifications

Symbol	Parameter	Min	Typ	Max
$t_{picjijh}$		100		
$t_{picahrl}$		0		
$t_{picrlrh}$		235		
$t_{picrhax}$		0		
$t_{picrdv}$				200
$t_{picrdz}$		10		
$t_{picrhrl}$		100		

### 3.0 Device Specifications (Continued)

#### 3.3.5.3 PARALLEL PORT

**TABLE 3-11. Parallel Port Compatibility Mode Handshake Timing Values**

Symbol	Measured At	Measured From	Measured to	Value (min/max)	Compliance
$T_{ready}$	Host Output	Busy $V_{IL}$	$\overline{Strobe} V_{OH}$	0 min	Compatible Hosts
$T_{setup(host)}$	Host Output	Data Stable	$\overline{Strobe} V_{OH}$	750 ns min	Compatible Hosts
$T_{setup(peripheral)}$	Peripheral Input	Data Stable	$\overline{Strobe} V_{IH}$	500 ns max*	Compatible Peripherals
$T_{strobe(host)}$	Host Output	$\overline{Strobe} V_{OL}$	$\overline{Strobe} > V_{OL}$	750 ns min 500 $\mu$ s max	Compatible Hosts
$T_{strobe(peripheral)}$	Peripheral Input	$\overline{Strobe} V_{IL}$	$\overline{Strobe} > V_{IL}$	500 ns max	Compatible Peripherals
$T_{hold(host)}$	Host Output	$\overline{Strobe} V_{OH}$	Data or $\overline{AutoFd}$ Change	750 ns min	Compatible Hosts
$T_{hold(peripheral)}$	Peripheral Input	$\overline{Strobe} V_{IL}$	Data or $\overline{AutoFd}$ Change	500 ns max	Compatible Peripherals
$T_{busy}$	Peripheral Output	$\overline{Strobe} V_{IL}$	Busy $V_{OH}$	500 ns max	Compliant Peripherals
$T_{reply}$	Peripheral Output	$\overline{Strobe} V_{IL}$	$\overline{Ack} V_{OH}$	0 min	Compatible Peripherals
$T_{ack}$	Peripheral Output	$\overline{Ack} V_{OL}$	$\overline{Ack} V_{OL}$	500 ns min 10 $\mu$ s max	Compatible Peripherals
$T_{nbusy}$	Peripheral Output	$\overline{Ack} V_{OH}$	Busy $V_{OH}$	0 min**	Compliant Peripherals
$T_{next}$	Host Output	$\overline{Ack} V_{IL}$	$\overline{Strobe} V_{OH}$	0 min	Compliant Hosts

**Note 1:** For more information on the history of Centronics Standard Parallel and PC-Compatible Parallel Interfaces, see annex Ca and in particular C.6.2 for Busy-to-Ack timing variations.

**Note 2:**  $V_{IL}$  is the low-level voltage input  
 $V_{OL}$  is the low-level voltage output  
 $V_{OH}$  is the high-level voltage output  
 $V_{IH}$  is the high-level voltage input

\*The maximum value stated for peripherals in this table are referenced to the peripheral. For example, the peripheral cannot require more than 500 ns data setup time.

\*\*Recognize that complementary signal changes may have overlapping signal transitions. The zero minimum value cannot be guaranteed.

**TABLE 3-12. Parallel Port IEEE 1284 Mode Handshake Timing Values**

Symbol	Parameter	Min	Max
$T_H$	Host Response Time	0	1.0s
$T_{\infty}$	Infinite Response Time	0	Infinite
$T_L$	Peripheral Response Time	0	35 ms
$T_R$	Peripheral Response Time (ECP Mode Only)	0	
$T_S$	Host Recovery Time (ECP Mode Only)	35 ms	
$T_P$	Minimum Setup or Pulse Width	0.5 $\mu$ s	
$T_D$	Minimum Data Setup Time (ECP/EPP Modes Only)	0	
$T_{ES}$	Short Response Time (EPP Mode Only)	0	125 ms
$T_{EL}$	Long Response Time (EPP Mode Only)	0	10 $\mu$ s
$T_{ER}$	Termination Pulse Width (EPP Mode Only)	50 $\mu$ s	Infinite

### 3.0 Device Specifications (Continued)

#### 3.3.5.4 PCMCIA CONTROLLER

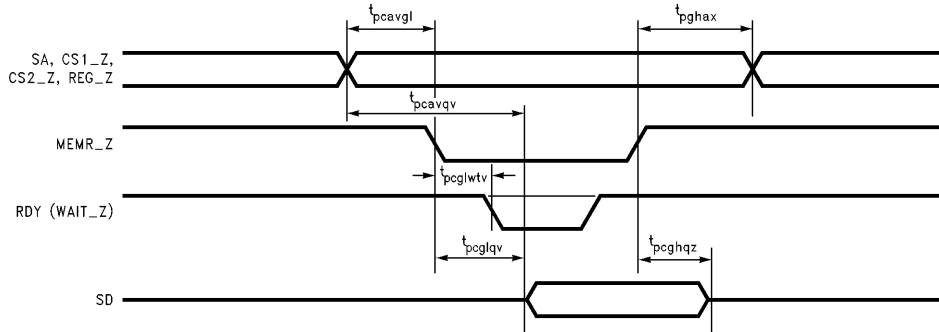

TL/EE/12514-21

FIGURE 3-12. Memory Read Timing

TABLE 3-13. PCMCIA Memory Read Timing Specifications

Symbol	Parameter	Condition	Min	Typ	Max
$t_{pcavgl}$			50 ns		
$t_{pgmax}$			20 ns		
$t_{pcglwtv}$					35 ns
$t_{pcavqv}$					250 ns
$t_{pcghqz}$			0 ns		
$t_{pcglqv}$					125 ns

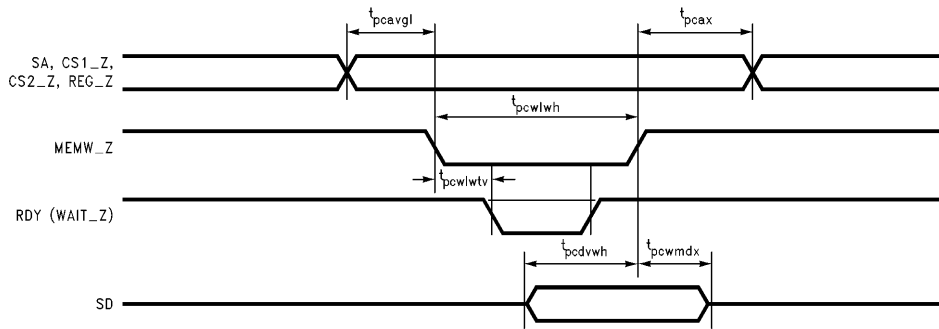

TL/EE/12514-22

FIGURE 3-13. Memory Write Timing Diagram

TABLE 3-14. Memory Write Timing Diagram

Symbol	Parameter	Condition	Min	Typ	Max
$t_{pcavgl}$			50 ns		
$t_{pcax}$			20 ns		
$t_{pcwlwh}$			$60 \text{ ns} + (t_{\text{sysclk}}) \cdot$ (number of waitstates)		
$t_{pcdvwh}$			100 ns		
$t_{pcwmdx}$			30 ns		
$t_{pcwlwtv}$					35 ns

### 3.0 Device Specifications (Continued)

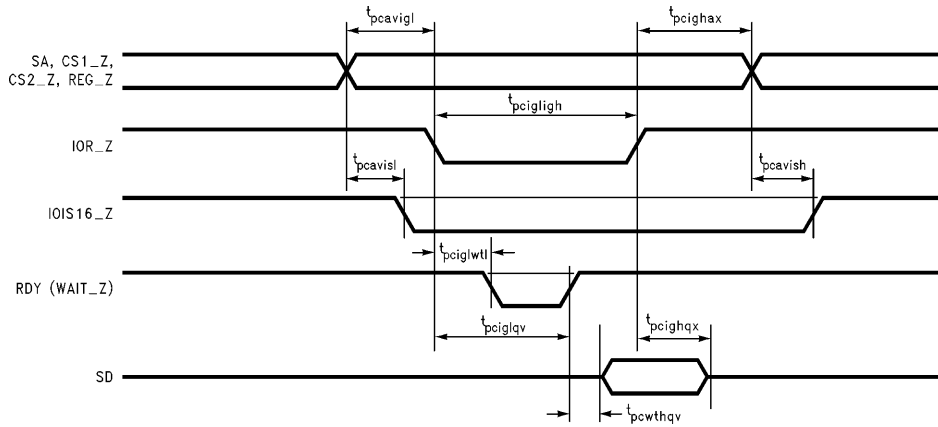

TL/EE/12514-23

FIGURE 3-14. I/O Read Timing

TABLE 3-15. PCMCIA I/O Read Specifications

Symbol	Parameter	Condition	Min	Typ	Max
$t_{pcavigl}$			100 ns		
$t_{pcighax}$			20 ns		
$t_{pcigligh}$			180 ns		
$t_{pcavisl}$					35 ns
$t_{pcavish}$					35 ns
$t_{pciglwtl}$					35 ns
$t_{pciglqv}$					120 ns
$t_{pcighqx}$			0 ns		
$t_{pcwthqv}$					35 ns

### 3.0 Device Specifications (Continued)

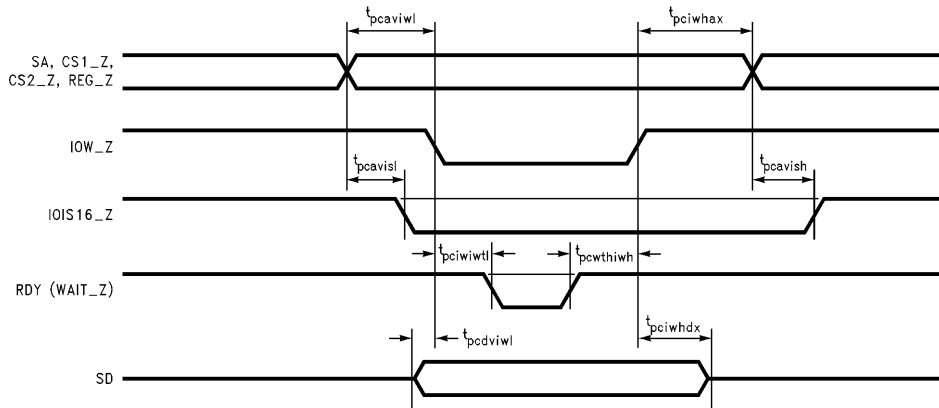

TL/EE/12514-24

FIGURE 3-15. I/O Write Timing Diagram

TABLE 3-16. PCMCIA I/O Write Specifications

Symbol	Parameter	Condition	Min	Typ	Max
$t_{pcaviwl}$			100 ns		
$t_{pciwhax}$			20 ns		
$t_{pcavisl}$					35 ns
$t_{pcavish}$					35 ns
$t_{pciwlwl}$					35 ns
$t_{pcdiwl}$			80 ns		
$t_{pcwthiwh}$			0 ns		
$t_{pciwhdx}$			30 ns		

### 3.0 Device Specifications (Continued)

#### 3.3.5.5 MICROWIRE (3-WIRE) & ACCESS.BUS

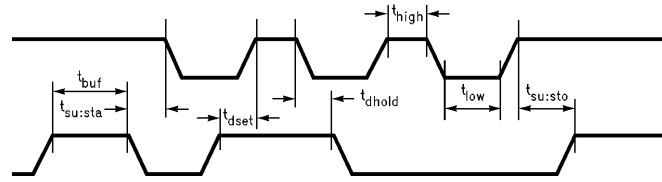

TL/EE/12514-25

FIGURE 3-16. Access.bus Timing Diagram

TABLE 3-17. Access.Bus Timing Specifications

Symbol	Parameter	Formula	Min	Max
$f_{sclk}$	SCLK Clock Frequency			100 kHz
$t_{buf}$	Bus Free Time between STOP and START Condition		4.7 $\mu$ s	
$t_{low}$	Low Period of the SCLK Clock		4.7 $\mu$ s	
$t_{high}$	High Period of the SCLK Clock		4.0 $\mu$ s	
$t_{dhold}$	Data Hold Time		250	
$t_{dset}$	Data Setup Time		250	
$t_{su:sto}$	Setup Time for STOP Condition		4.0 $\mu$ s	
$t_{su:sta}$	Hold Time for START Condition		4.7 $\mu$ s	

### 3.0 Device Specifications (Continued)

#### 3.3.5.6 FIFO UART

Symbol	Parameter	Condition	Min	Max	Units
D	OSC Clock Divider		1	63	CLKs
D	Baud Divisor		1	65535	CLKs
$t_{BHD}$	Baud Output Positive Edge Delay			56	ns
$t_{BLD}$	Baud Output Negative Edge Delay			56	ns

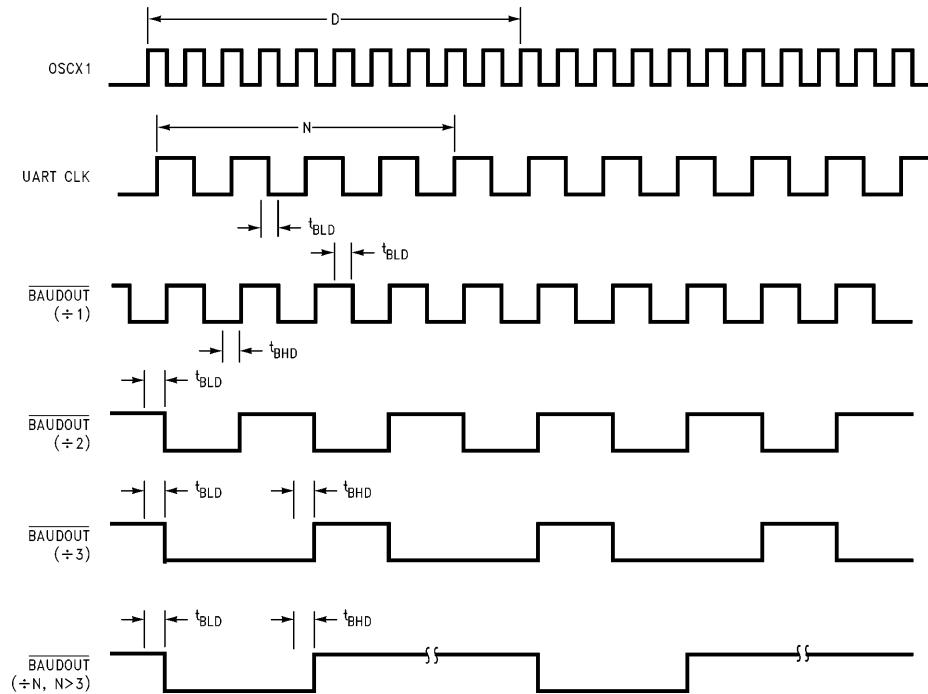

TL/EE/12514-26

Symbol	Parameter	Condition	Min	Max	Units
$t_{IRTXW}$	IRTX Pulse Width		1.6 $\mu$ s	3/16	BAUD OUT Cycles
$t_{IRRXW}$	IRRX Pulse Width		1.6 $\mu$ s	6/16	BAUD OUT Cycles

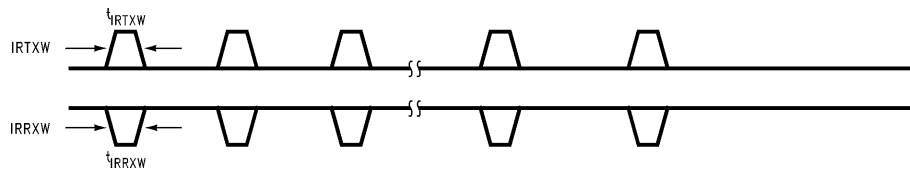

TL/EE/12514-27

FIGURE 3-17. UART Baud Rate and Infrared Clocks

### 3.0 Device Specifications (Continued)

Symbol	Parameter	Min	Max	Units
$t_{SINT}$	Delay from Stop Bit to Set Interrupt		2	BAUDOUT Cycles
$t_{STI}$	Delay from Start Bit to IRQ		8	BAUDOUT Cycles
$t_{SI}$	Delay from Initial Write to IRQ	16	24	BAUDOUT Cycles
$t_{IRS}$	Delay from IRQ Reset to Tx Start	8	24	BAUDOUT Cycles
$t_{MDO}$	Delay from Write to Output		40	ns
$t_{RIM}$	Delay to Reset IRQA from Read		78	ns
$t_{SIM}$	Delay to Set IRQ from Modem Input		40	ns

$$\text{BAUDOUT Cycle} = \frac{\text{Input Clock Frequency}}{16 \times \text{Baudrate Divisor}}$$

$$\text{Input Clock Frequency} = \frac{\text{OSCX1 Frequency}}{\text{UART Clock Divisor}}$$

Registers: Divisor Latch Holds Baudrate Divisor  
EF70 holds UART Clock Divisor

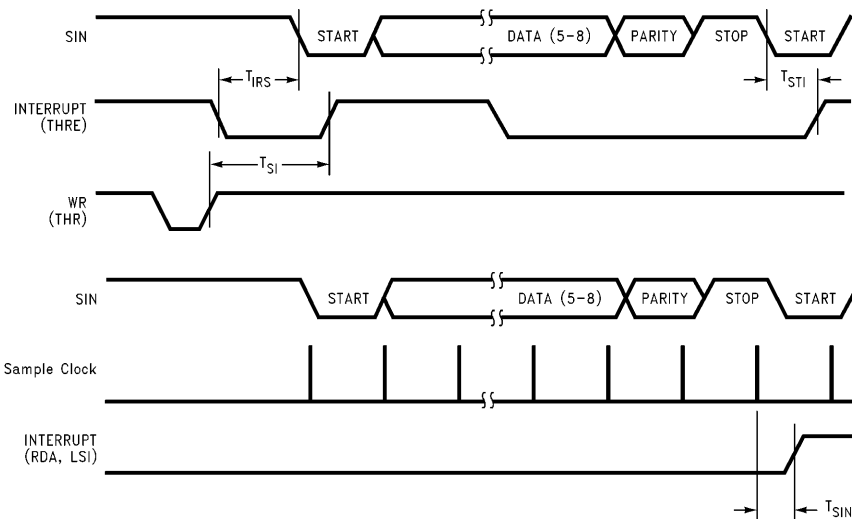

TL/EE/12514-28

TL/EE/12514-29

FIGURE 3-18. UART IRQ Timing



**3.0 Device Specifications** (Continued)

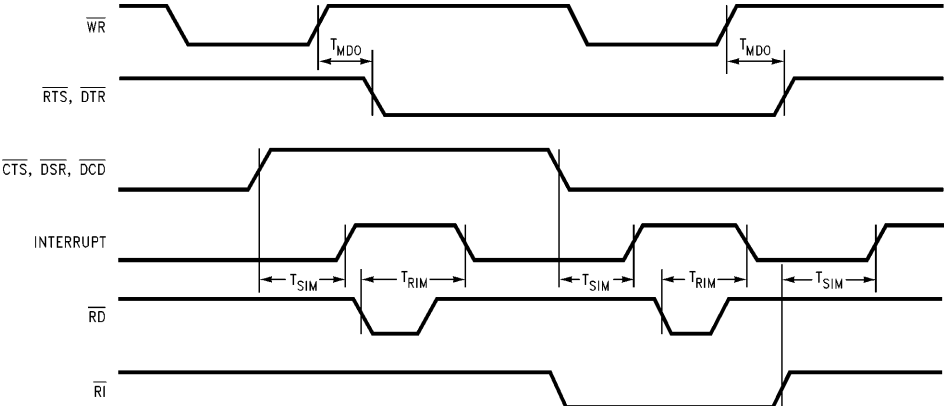

**FIGURE 3-19. UART Modem Control Timing**

TL/EE/12514-30



### 3.0 Device Specifications (Continued)

#### 3.3.5.8 SUPPORTED TESTMODES

Symbol	Parameter	Conditions	Min	Max	Units
$t_{AND}$	AND Function Result Delay			1	ms
$t_{HILO}$	HI/LO Function Drive Delay			1	ms
$t_{TRI}$	TRI-STATE Outputs Delay			1	ms
$t_{TOG}$	Toggle Function Delay			1	ms

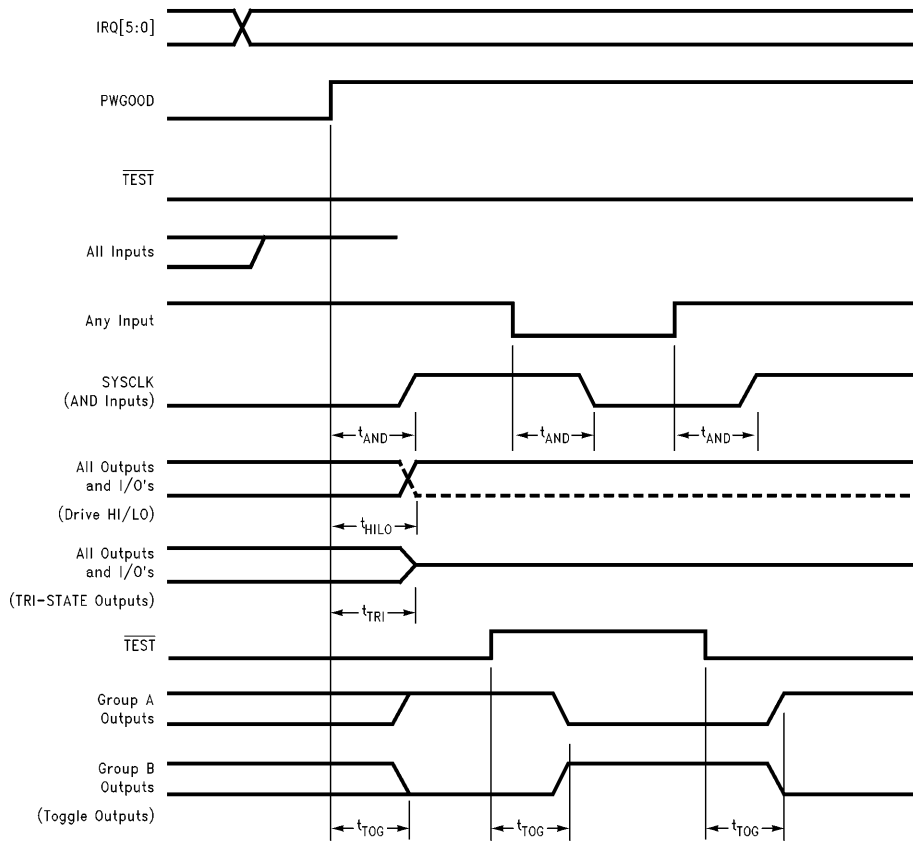

FIGURE 3-21. Testmode Timing Diagram

TL/EE/12514-32





**PACKAGING INFORMATION**

Orderable part number	Status (1)	Material type (2)	Package   Pins	Package qty   Carrier	RoHS (3)	Lead finish/ Ball material (4)	MSL rating/ Peak reflow (5)	Op temp (°C)	Part marking (6)
<a href="#">NS486SXF-25/NOPB</a>	Active	Production	QFP (NBK)   160	24   AMMO	Yes	SN	Level-3-245C-168 HR	-	
NS486SXF-25/NOPB.A	Active	Production	QFP (NBK)   160	24   AMMO	Yes	SN	Level-3-245C-168 HR	See NS486SXF-25/ NOPB	

(1) **Status:** For more details on status, see our [product life cycle](#).

(2) **Material type:** When designated, preproduction parts are prototypes/experimental devices, and are not yet approved or released for full production. Testing and final process, including without limitation quality assurance, reliability performance testing, and/or process qualification, may not yet be complete, and this item is subject to further changes or possible discontinuation. If available for ordering, purchases will be subject to an additional waiver at checkout, and are intended for early internal evaluation purposes only. These items are sold without warranties of any kind.

(3) **RoHS values:** Yes, No, RoHS Exempt. See the [TI RoHS Statement](#) for additional information and value definition.

(4) **Lead finish/Ball material:** Parts may have multiple material finish options. Finish options are separated by a vertical ruled line. Lead finish/Ball material values may wrap to two lines if the finish value exceeds the maximum column width.

(5) **MSL rating/Peak reflow:** The moisture sensitivity level ratings and peak solder (reflow) temperatures. In the event that a part has multiple moisture sensitivity ratings, only the lowest level per JEDEC standards is shown. Refer to the shipping label for the actual reflow temperature that will be used to mount the part to the printed circuit board.

(6) **Part marking:** There may be an additional marking, which relates to the logo, the lot trace code information, or the environmental category of the part.

Multiple part markings will be inside parentheses. Only one part marking contained in parentheses and separated by a "-" will appear on a part. If a line is indented then it is a continuation of the previous line and the two combined represent the entire part marking for that device.

**Important Information and Disclaimer:** The information provided on this page represents TI's knowledge and belief as of the date that it is provided. TI bases its knowledge and belief on information provided by third parties, and makes no representation or warranty as to the accuracy of such information. Efforts are underway to better integrate information from third parties. TI has taken and continues to take reasonable steps to provide representative and accurate information but may not have conducted destructive testing or chemical analysis on incoming materials and chemicals. TI and TI suppliers consider certain information to be proprietary, and thus CAS numbers and other limited information may not be available for release.

In no event shall TI's liability arising out of such information exceed the total purchase price of the TI part(s) at issue in this document sold by TI to Customer on an annual basis.

**TRAY**

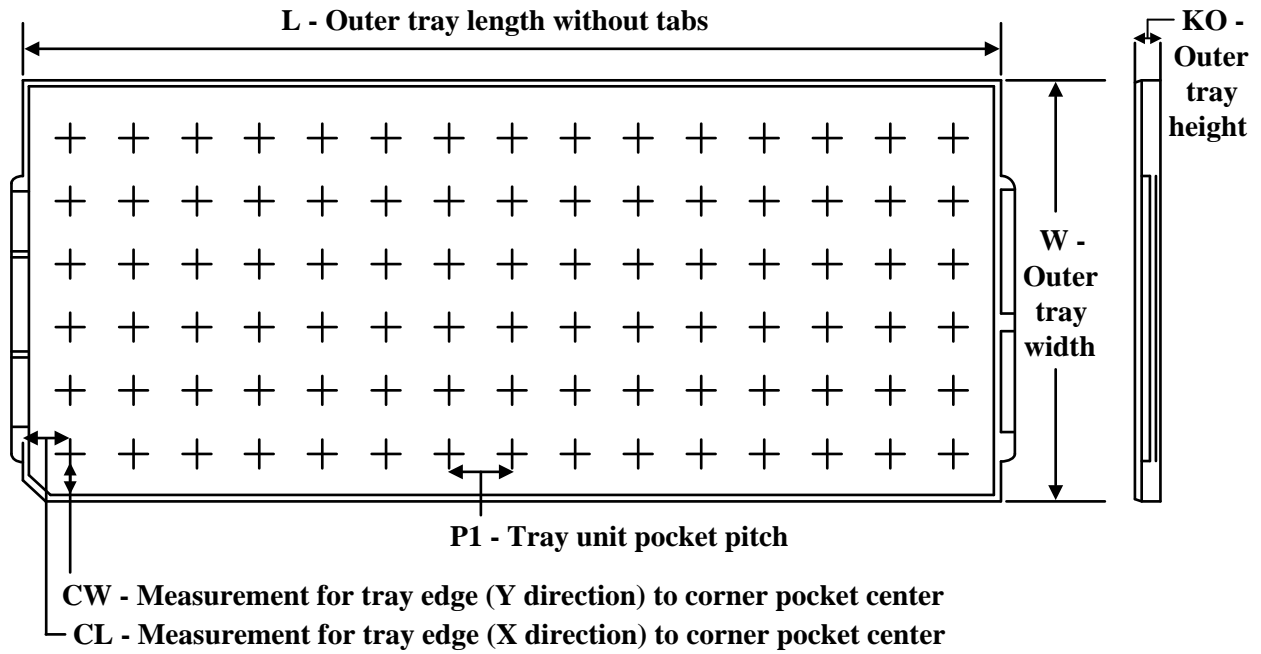

Chamfer on Tray corner indicates Pin 1 orientation of packed units.

\*All dimensions are nominal

Device	Package Name	Package Type	Pins	SPQ	Unit array matrix	Max temperature (°C)	L (mm)	W (mm)	K0 (µm)	P1 (mm)	CL (mm)	CW (mm)
NS486SXF-25/NOPB	NBK	QFP	160	24	3 X 8	150	322.6	135.9	7620	37.02	27.93	30.93
NS486SXF-25/NOPB.A	NBK	QFP	160	24	3 X 8	150	322.6	135.9	7620	37.02	27.93	30.93

## IMPORTANT NOTICE AND DISCLAIMER

TI PROVIDES TECHNICAL AND RELIABILITY DATA (INCLUDING DATASHEETS), DESIGN RESOURCES (INCLUDING REFERENCE DESIGNS), APPLICATION OR OTHER DESIGN ADVICE, WEB TOOLS, SAFETY INFORMATION, AND OTHER RESOURCES "AS IS" AND WITH ALL FAULTS, AND DISCLAIMS ALL WARRANTIES, EXPRESS AND IMPLIED, INCLUDING WITHOUT LIMITATION ANY IMPLIED WARRANTIES OF MERCHANTABILITY, FITNESS FOR A PARTICULAR PURPOSE OR NON-INFRINGEMENT OF THIRD PARTY INTELLECTUAL PROPERTY RIGHTS.

These resources are intended for skilled developers designing with TI products. You are solely responsible for (1) selecting the appropriate TI products for your application, (2) designing, validating and testing your application, and (3) ensuring your application meets applicable standards, and any other safety, security, regulatory or other requirements.

These resources are subject to change without notice. TI grants you permission to use these resources only for development of an application that uses the TI products described in the resource. Other reproduction and display of these resources is prohibited. No license is granted to any other TI intellectual property right or to any third party intellectual property right. TI disclaims responsibility for, and you fully indemnify TI and its representatives against any claims, damages, costs, losses, and liabilities arising out of your use of these resources.

TI's products are provided subject to [TI's Terms of Sale](#), [TI's General Quality Guidelines](#), or other applicable terms available either on [ti.com](http://ti.com) or provided in conjunction with such TI products. TI's provision of these resources does not expand or otherwise alter TI's applicable warranties or warranty disclaimers for TI products. Unless TI explicitly designates a product as custom or customer-specified, TI products are standard, catalog, general purpose devices.

TI objects to and rejects any additional or different terms you may propose.

Copyright © 2025, Texas Instruments Incorporated

Last updated 10/2025