

12V, 7MHz, CMOS, Rail-to-Rail I/O OPERATIONAL AMPLIFIERS

FEATURES

- **HIGH SPEED:** 7MHz, 10V/ μ s
- **RAIL-TO-RAIL INPUT AND OUTPUT**
- **WIDE SUPPLY RANGE:**
Single Supply: 3.5V to 12V
Dual Supplies: ± 1.75 V to ± 6 V
- **LOW QUIESCENT CURRENT:** 1.1mA
- **FULL-SCALE CMRR:** 84dB
- **MicroSIZE PACKAGES:**
SOT23-5, MSOP-8, TSSOP-14
- **LOW INPUT BIAS CURRENT:** 1pA

APPLICATIONS

- **LCD GAMMA CORRECTION**
- **AUTOMOTIVE APPLICATIONS:**
Audio, Sensor Applications, Security Systems
- **PORTABLE EQUIPMENT**
- **ACTIVE FILTERS**
- **TRANSDUCER AMPLIFIER**
- **TEST EQUIPMENT**
- **DATA ACQUISITION**

DESCRIPTION

The OPA743 series utilizes a state-of-the-art 12V analog CMOS process and offers outstanding AC performance, such as 7MHz GBW, 10V/ μ s slew rate and 0.0008% THD+N. Optimized for single supply operation up to 12V, the input common-mode range extends beyond the power supply rails and the output swings to within 100mV of the rails. The low quiescent current of 1.1mA makes it well suited for use in battery operated equipment.

The OPA743 series' ability to drive high output currents together with 12V operation makes it particularly useful for use as gamma correction reference buffer in LCD panels.

For ease of use the OPA743 op-amp family is fully specified and tested over the supply range of ± 1.75 V to ± 6 V. Single, dual and quad versions are available.

The single versions (OPA743) are available in the *MicroSIZE* SOT23-5 and in the standard SO-8 surface-mount, as well as DIP-8 packages. Dual versions (OPA2743) are available versions in the MSOP-8, SO-8, and DIP-8 packages. The quad versions (OPA4743) are available in the TSSOP-14 and SO-14 packages. All are specified for operation from -40° C to $+85^{\circ}$ C.

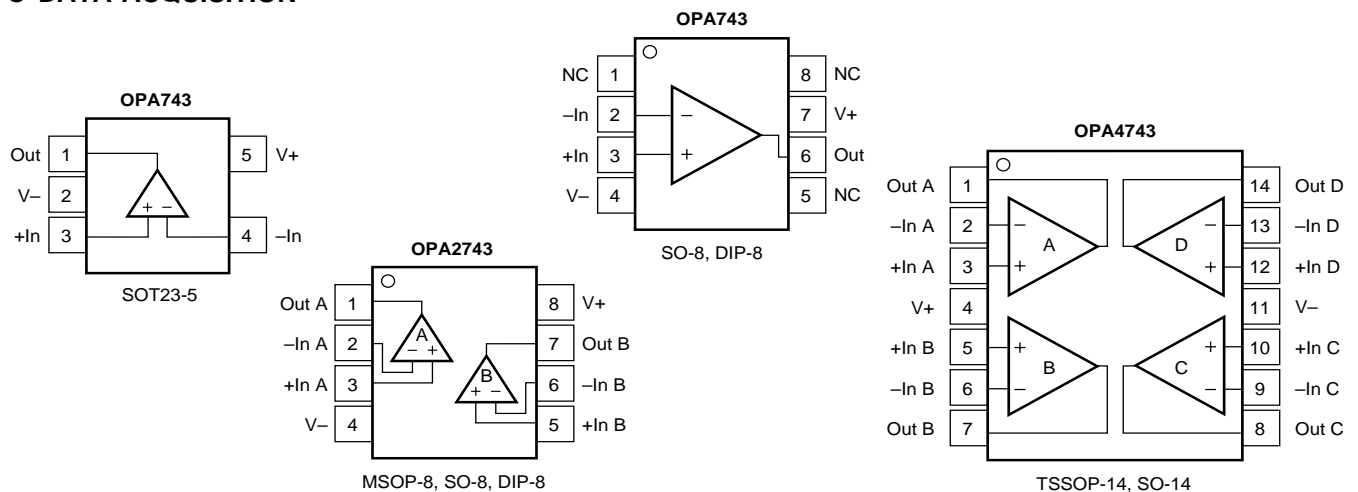

Please be aware that an important notice concerning availability, standard warranty, and use in critical applications of Texas Instruments semiconductor products and disclaimers thereto appears at the end of this data sheet.

ABSOLUTE MAXIMUM RATINGS⁽¹⁾

Supply Voltage, V+ to V-.....	13.2V
Signal Input Terminals, Voltage ⁽²⁾	(V-) -0.3V to (V+) +0.3V
Current ⁽²⁾	10mA
Output Short-Circuit ⁽³⁾	Continuous
Operating Temperature.....	-55°C to +125°C
Storage Temperature.....	-65°C to +150°C
Junction Temperature.....	+150°C
Lead Temperature (soldering, 10s).....	+300°C

NOTES: (1) Stresses above these ratings may cause permanent damage. Exposure to absolute maximum conditions for extended periods may degrade device reliability. (2) Input terminals are diode-clamped to the power supply rails. Input signals that can swing more than 0.3V beyond the supply rails should be current-limited to 10mA or less. (3) Short-circuit to ground, one amplifier per package.



ELECTROSTATIC DISCHARGE SENSITIVITY

This integrated circuit can be damaged by ESD. Texas Instruments recommends that all integrated circuits be handled with appropriate precautions. Failure to observe proper handling and installation procedures can cause damage.

ESD damage can range from subtle performance degradation to complete device failure. Precision integrated circuits may be more susceptible to damage because very small parametric changes could cause the device not to meet its published specifications.

PACKAGE/ORDERING INFORMATION

PRODUCT	PACKAGE	PACKAGE DRAWING NUMBER	PACKAGE MARKING	ORDERING NUMBER ⁽¹⁾	TRANSPORT MEDIA
Single					
OPA743NA	SOT23-5	331	D43	OPA743NA/250	Tape and Reel
"	"	"	"	OPA743NA/3K	Tape and Reel
OPA743UA	SO-8	182	OPA743UA	OPA743UA	Rails
"	"	"	"	OPA743UA/2K5	Tape and Reel
OPA743PA	DIP-8	006	OPA743PA	OPA743PA	Rails
Dual					
OPA2743EA	MSOP-8	337	E43	OPA2743EA/250	Tape and Reel
"	"	"	"	OPA2743EA/2K5	Tape and Reel
OPA2743UA	SO-8	182	OPA2743UA	OPA2743UA	Rails
"	"	"	"	OPA2743UA/2K5	Tape and Reel
OPA2743PA	DIP-8	006	OPA2743PA	OPA2743PA	Rails
Quad					
OPA4743EA	TSSOP-14	357	OPA4743EA	OPA4743EA/250	Tape and Reel
"	"	"	"	OPA4743EA/2K5	Tape and Reel
OPA4743UA	SO-14	235	OPA4743UA	OPA4743UA	Rails
"	"	"	"	OPA4743UA/2K5	Tape and Reel

NOTE: (1) Models with a slash (/) are available only in Tape and Reel in the quantities indicated (e.g., /3K indicates 3000 devices per reel). Ordering 3000 pieces of "OPA743NA/3K" will get a single 3000-piece Tape and Reel.

ELECTRICAL CHARACTERISTICS: $V_S = 3.5V$ to $12V$

Boldface limits apply over the specified temperature range, $T_A = -40^{\circ}C$ to $+85^{\circ}C$

At $T_A = +25^{\circ}C$, $R_L = 10k\Omega$ connected to $V_S/2$ and $V_{OUT} = V_S/2$, unless otherwise noted.

PARAMETER	CONDITION	OPA743NA, UA, PA OPA2743EA, UA, PA OPA4743EA, UA			UNITS
		MIN	TYP	MAX	
OFFSET VOLTAGE Input Offset Voltage Drift vs Power Supply Over Temperature Channel Separation, dc $f = 10kHz$	V_{OS} dV_{OS}/dT PSRR $V_S = \pm 5V, V_{CM} = 0V$ $T_A = -40^{\circ}C$ to $+85^{\circ}C$ $V_S = \pm 1.75V$ to $\pm 6V, V_{CM} = -0.25$ $V_S = \pm 1.75V$ to $\pm 6V, V_{CM} = -0.25$		± 1.5 ± 8 10 1 110	± 7 100 200	mV $\mu V/^{\circ}C$ $\mu V/V$ $\mu V/V$ $\mu V/V$ dB
INPUT VOLTAGE RANGE Common-Mode Voltage Range Common-Mode Rejection Ratio over Temperature over Temperature	V_{CM} CMRR $V_S = \pm 5V, (V-) - 0.1V < V_{CM} < (V+) + 0.1V$ $V_S = \pm 5V, (V-) < V_{CM} < (V+)$ $V_S = \pm 5V, (V-) - 0.1V < V_{CM} < (V+) - 2V$ $V_S = \pm 5V, (V-) < V_{CM} < (V+) - 2V$ $V_S = \pm 1.75V, (V-) - 0.1V < V_{CM} < (V+) + 0.1V$	$(V-) - 0.1$ 66 60 70 70 60	84 90	$(V+) + 0.1$ 	V dB dB dB dB dB
INPUT BIAS CURRENT Input Bias Current Input Offset Current	I_B I_{OS} $V_S = \pm 6V, V_{CM} = 0V$ $V_S = \pm 6V, V_{CM} = 0V$		± 1 ± 0.5	± 10 ± 10	pA pA
INPUT IMPEDANCE Differential Common-Mode			$4 \cdot 10^9 \parallel 4$ $5 \cdot 10^{12} \parallel 4$		$\Omega \parallel pF$ $\Omega \parallel pF$
NOISE Input Voltage Noise, $f = 0.1Hz$ to $10Hz$ Input Voltage Noise Density, $f = 10kHz$ Current Noise Density, $f = 1kHz$	e_n i_n $V_S = \pm 6V, V_{CM} = 0V$ $V_S = \pm 6V, V_{CM} = 0V$ $V_S = \pm 6V, V_{CM} = 0V$		11 30 2.5		$\mu Vp-p$ nV/\sqrt{Hz} fA/\sqrt{Hz}
OPEN-LOOP GAIN Open-Loop Voltage Gain over Temperature over Temperature	A_{OL} $R_L = 100k\Omega, (V-)+0.1V < V_O < (V+)-0.1V$ $R_L = 100k\Omega, (V-)+0.125V < V_O < (V+)-0.125V$ $R_L = 1k, (V-)+0.325V < V_O < (V+)-0.325V$ $R_L = 1k, (V-)+0.450 < V_O < (V+)-0.450V$	106 100 86 96	120 100		dB dB dB dB
OUTPUT Voltage Output Swing from Rail over Temperature over Temperature Output Current Short-Circuit Current Capacitive Load Drive	I_{OUT} I_{SC} C_{LOAD} $R_L = 100k\Omega, A_{OL} > 106dB$ $R_L = 100k\Omega, A_{OL} > 100dB$ $R_L = 1k\Omega, A_{OL} > 86dB$ $R_L = 1k\Omega, A_{OL} > 96dB$ $ V_S - V_{OUT} < 1V$		75 100 300 425 ± 20 ± 30	100 125 325 450	mV mV mV mV mA mA
FREQUENCY RESPONSE Gain-Bandwidth Product Slew Rate Settling Time, 0.1% 0.01% Overload Recovery Time Total Harmonic Distortion + Noise	GBW SR t_s t_s THD+N $C_L = 15pF$ $G = +1$ $V_S = \pm 6V, G = +1$ $V_S = \pm 6V, 5V$ Step, $G = +1$ $V_S = \pm 6V, 5V$ Step, $G = +1$ $V_{IN} \cdot \text{Gain} = V_S$ $V_S = \pm 6V, V_O = 1V_{rms}, G = +1, f = 6kHz$		7 10 9 15 200 0.0008		MHz $V/\mu s$ μs μs ns %
POWER SUPPLY Specified Voltage Range, Single Supply Specified Voltage Range, Dual Supplies Quiescent Current (per amplifier) over Temperature	V_S V_S I_Q $I_Q = 0$	3.5 ± 1.75	1.1	12 ± 6 1.5 1.7	V V mA mA
TEMPERATURE RANGE Specified Range Operating Range Storage Range Thermal Resistance SOT23-5 Surface-Mount MSOP-8 Surface-Mount TSSOP-14 Surface-Mount SO-8 Surface Mount SO-14 Surface Mount DIP-8	θ_{JA}	-40 -55 -65		85 125 150	$^{\circ}C$ $^{\circ}C$ $^{\circ}C$ $^{\circ}C/W$ $^{\circ}C/W$ $^{\circ}C/W$ $^{\circ}C/W$ $^{\circ}C/W$ $^{\circ}C/W$

TYPICAL CHARACTERISTICS

At $T_A = +25^\circ\text{C}$, $V_S = \pm 6\text{V}$, and $R_L = 10\text{k}\Omega$, unless otherwise noted.

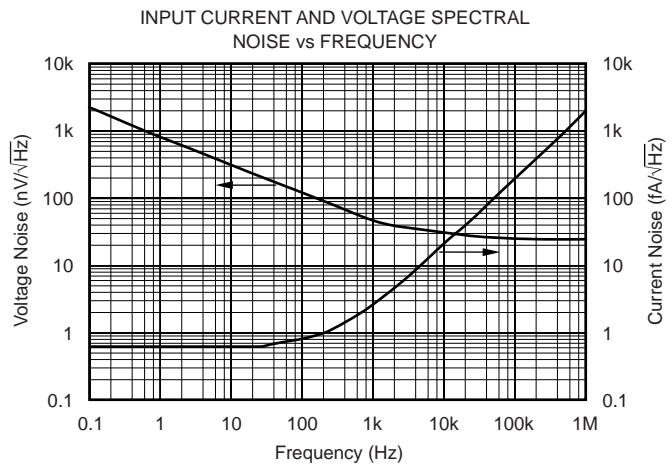
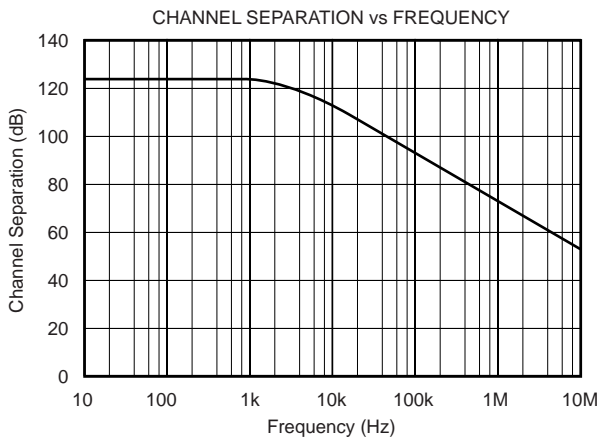
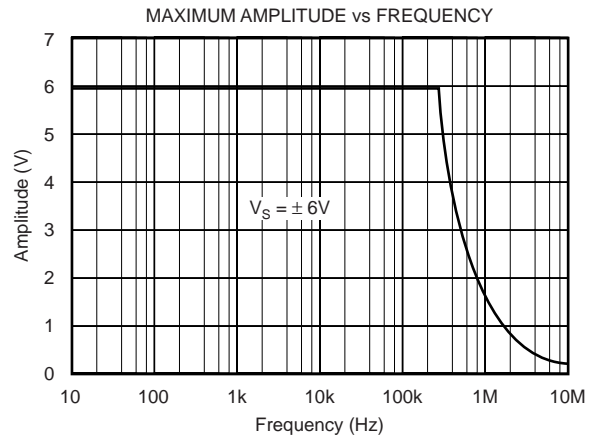
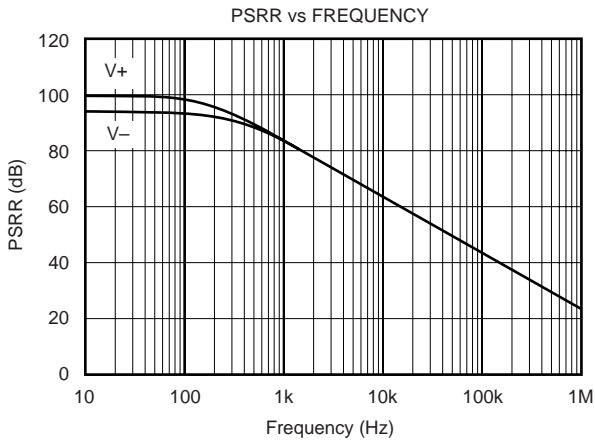
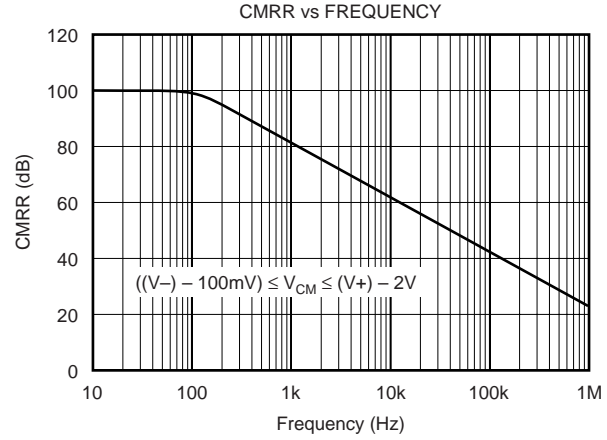
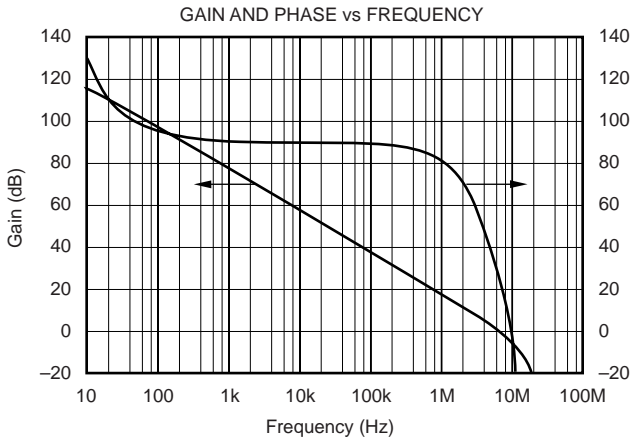

TYPICAL CHARACTERISTICS (Cont.)

At $T_A = +25^\circ\text{C}$, $V_S = \pm 5\text{V}$, and $R_L = 10\text{k}\Omega$, unless otherwise noted.

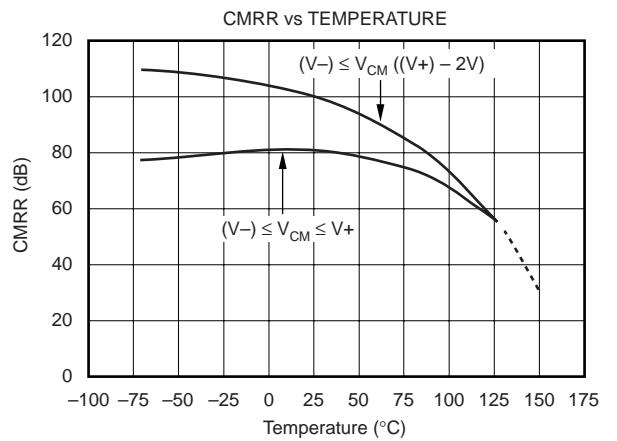
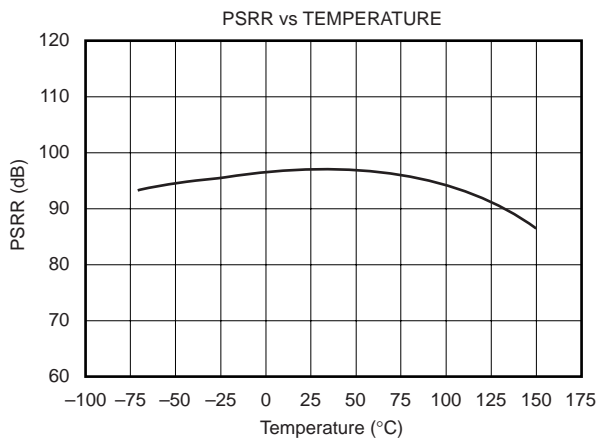
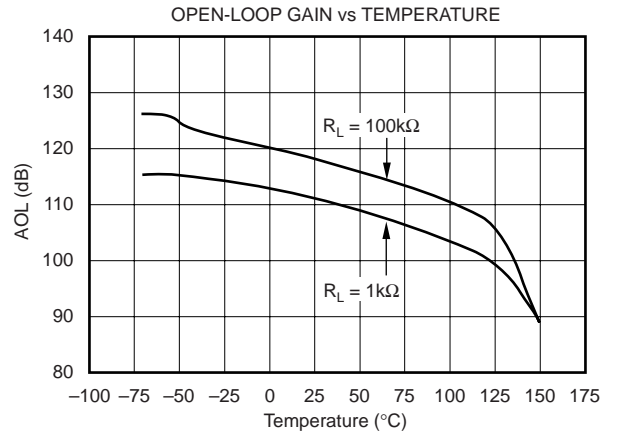
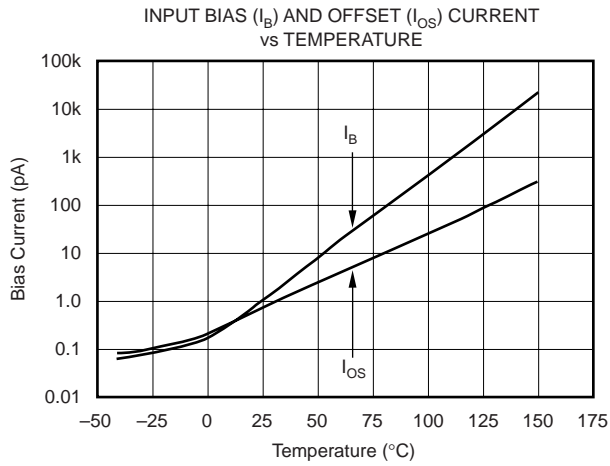
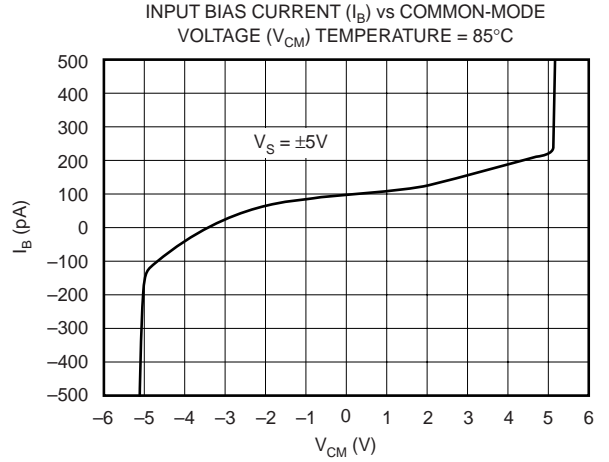
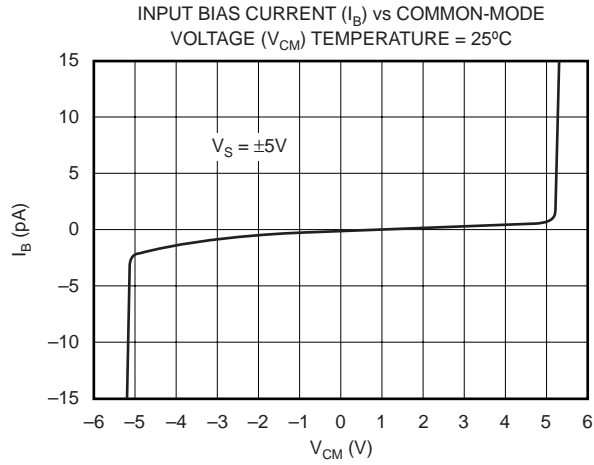

TYPICAL CHARACTERISTICS (Cont.)

At $T_A = +25^\circ\text{C}$, $V_S = \pm 6\text{V}$, and $R_L = 10\text{k}\Omega$, unless otherwise noted.

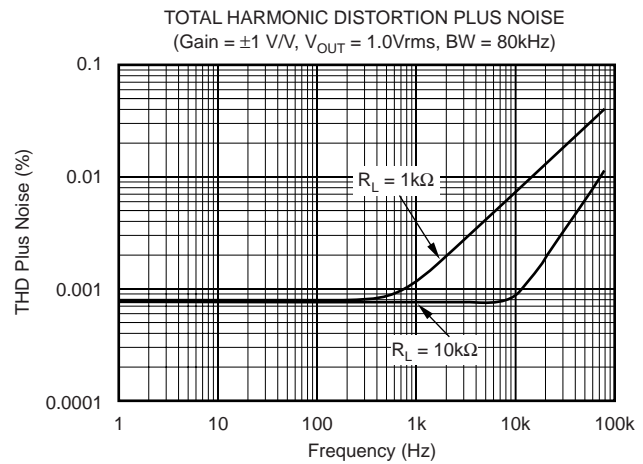
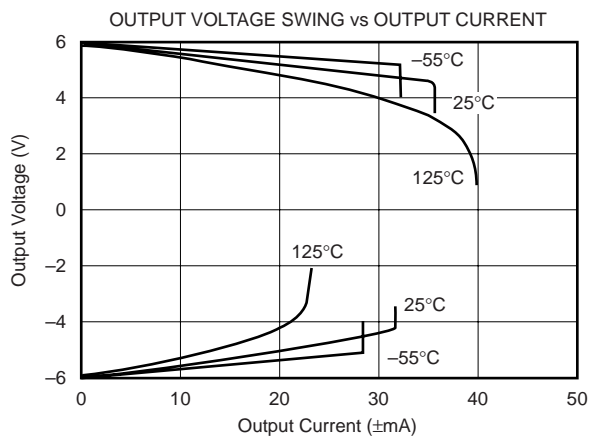
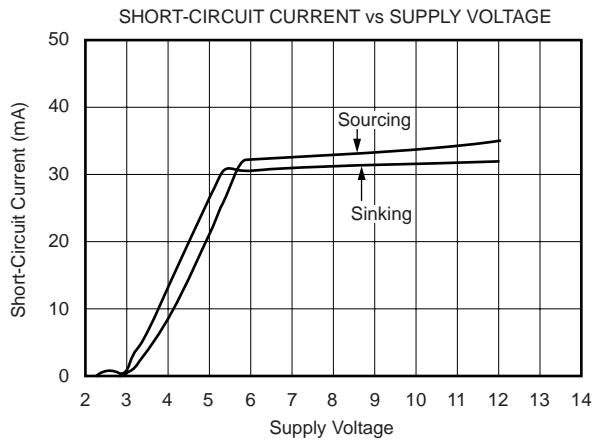
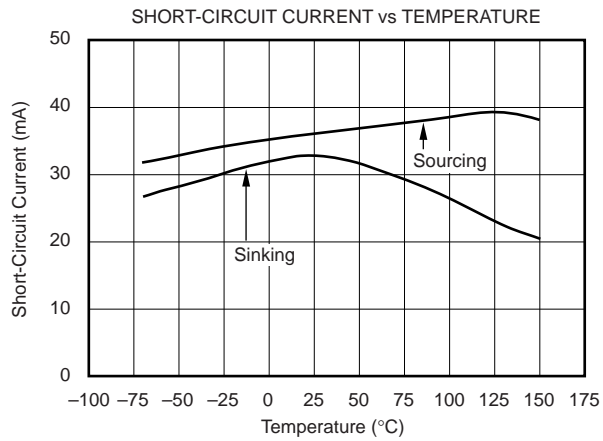
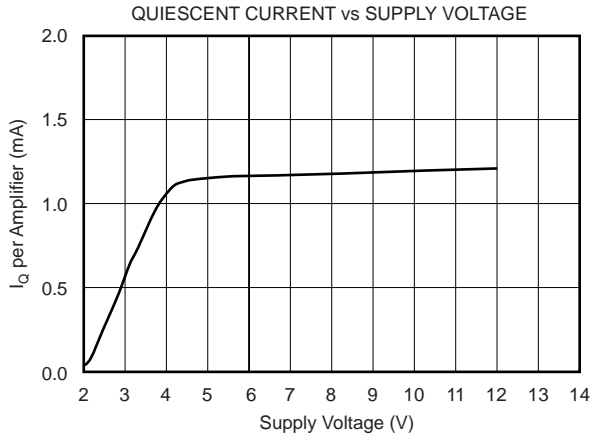
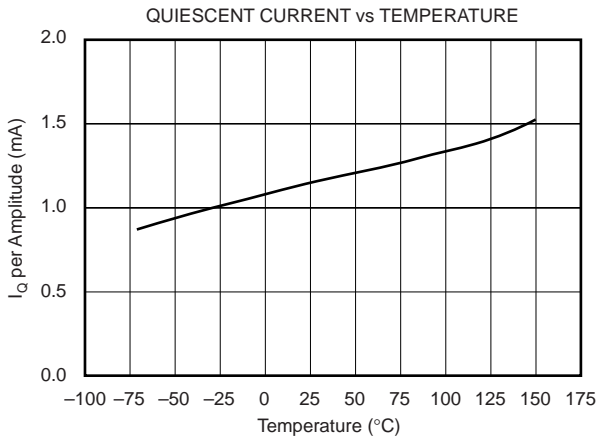

TYPICAL CHARACTERISTICS (Cont.)

At $T_A = +25^\circ\text{C}$, $V_S = \pm 6\text{V}$, and $R_L = 10\text{k}\Omega$, unless otherwise noted.

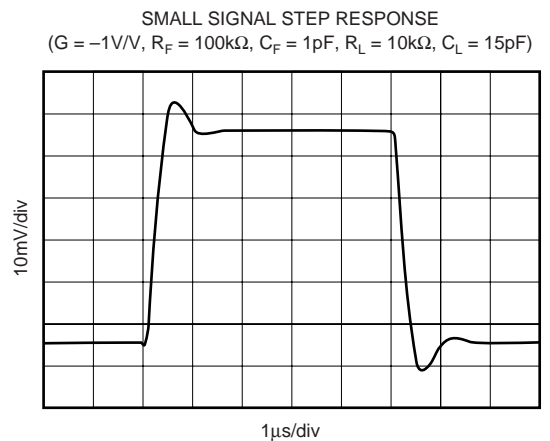
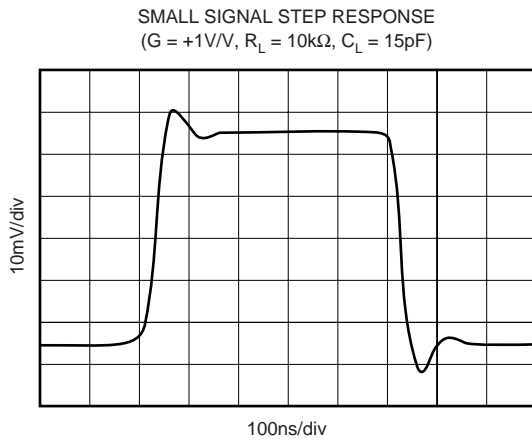
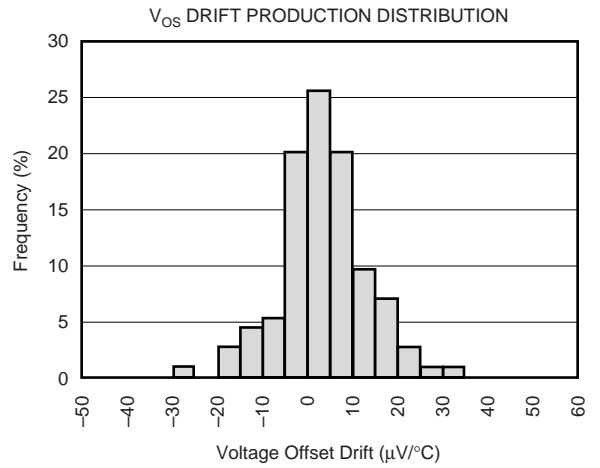
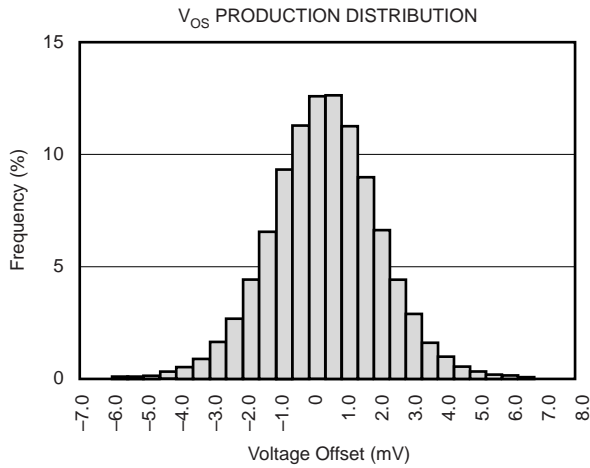
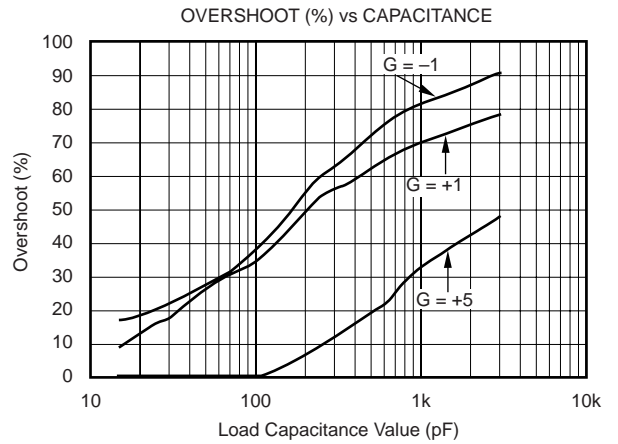
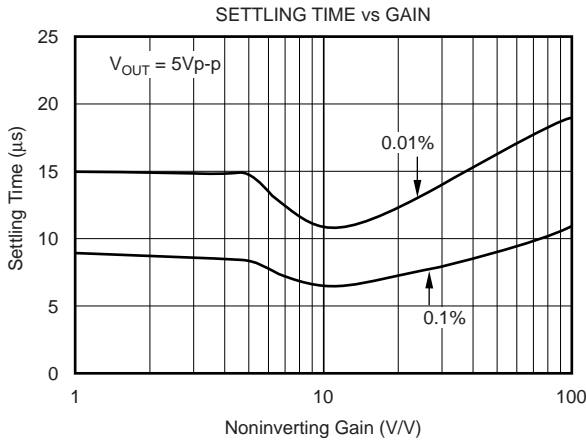

NOTE: C_F is used to optimize settling time.

TYPICAL CHARACTERISTICS (Cont.)

At $T_A = +25^\circ\text{C}$, $V_S = \pm 6\text{V}$, and $R_L = 10\text{k}\Omega$, unless otherwise noted.

LARGE SIGNAL STEP RESPONSE
($G = +1\text{V/V}$, $R_L = 10\text{k}\Omega$, $C_L = 15\text{pF}$)

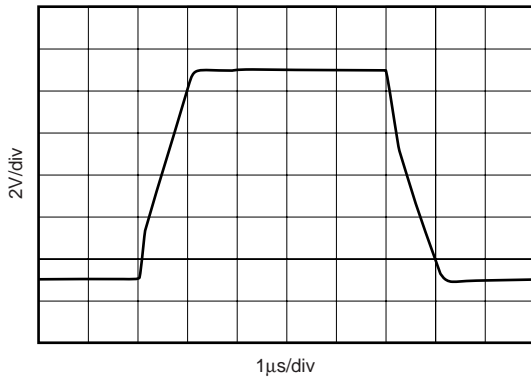

LARGE SIGNAL STEP RESPONSE
($G = -1\text{V/V}$, $R_L = 10\text{k}\Omega$, $C_L = 15\text{pF}$)

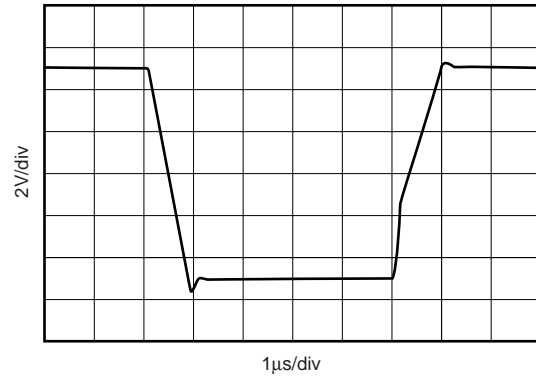

APPLICATIONS INFORMATION

OPA743 series op amps can operate on 1.1mA quiescent current from a single (or split) supply in the range of 3.5V to 12V ($\pm 1.75\text{V}$ to $\pm 6\text{V}$), making them highly versatile and easy to use. The OPA743 is unity-gain stable and offers 7MHz bandwidth and 10V/ μs slew rate.

Rail-to-rail input and output swing helps maintain dynamic range, especially in low supply applications. Figure 1 shows the input and output waveforms for the OPA743 in unity-gain configuration. On a $\pm 6\text{V}$ supply with a 100k Ω load connected to $V_S/2$. The output is tested to swing within 100mV to the rail.

Power-supply pins should be bypassed with 1000pF ceramic capacitors in parallel with 1 μF tantalum capacitors.

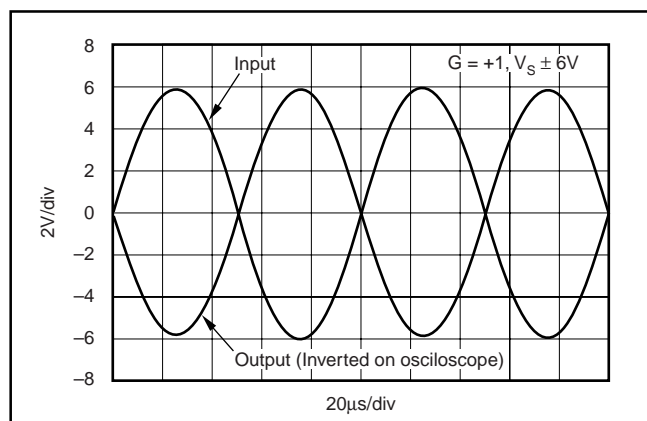

FIGURE 1. Rail-to-Rail Input and Output.

OPERATING VOLTAGE

OPA743 series op amps are fully specified and guaranteed from 3.5V to 12V over a temperature range of -40°C to $+85^{\circ}\text{C}$. Parameters that vary significantly with operating voltages or temperature are shown in the Typical Characteristics.

RAIL-TO-RAIL INPUT

The input common-mode voltage range of the OPA743 series extends 100mV beyond the supply rails at room temperature. This is achieved with a complementary input stage—an N-channel input differential pair in parallel with a P-channel differential pair. The N-channel pair is active for input voltages close to the positive rail, typically $(V+) - 2.0\text{V}$ to 100mV above the positive supply, while the P-channel pair is on for inputs from 100mV below the negative supply to approximately $(V+) - 1.5\text{V}$. There is a small transition region, typically $(V+) - 2.0\text{V}$ to $(V+) - 1.5\text{V}$, in which both pairs are on. This 500mV transition region can vary $\pm 100\text{mV}$ with process variation. Thus, the transition region (both stages on) can range from $(V+) - 2.1\text{V}$ to $(V+) - 1.4\text{V}$ on the low end, up to $(V+) - 1.9\text{V}$ to $(V+) - 1.6\text{V}$ on the high end. Most rail-to-rail op amps on the market use this two input stage approach, and exhibit a transition region where CMRR, offset voltage, and THD may vary compared to operation outside this region.

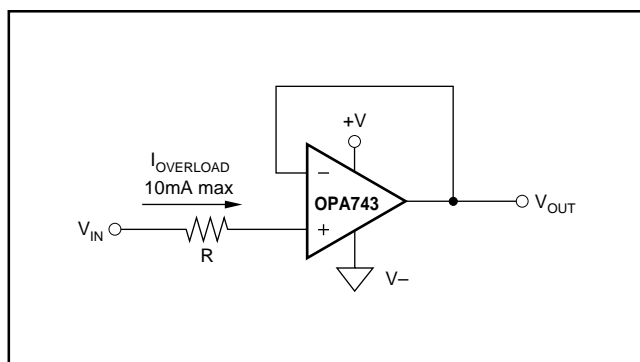

FIGURE 2. Input Current Protection for Voltages Exceeding the Supply Voltage.

INPUT VOLTAGE

Device inputs are protected by ESD diodes that will conduct if the input voltages exceed the power supplies by more than approximately 300mV. Momentary voltages greater than 300mV beyond the power supply can be tolerated if the current is limited to 10mA. This is easily accomplished with an input resistor, in series with the op amp input as shown in Figure 2. Many input signals are inherently current-limited to less than 10mA; therefore, a limiting resistor is not always required. The OPA743 features no phase inversion when the inputs extend beyond supplies if the input current is limited, as seen in Figure 3.

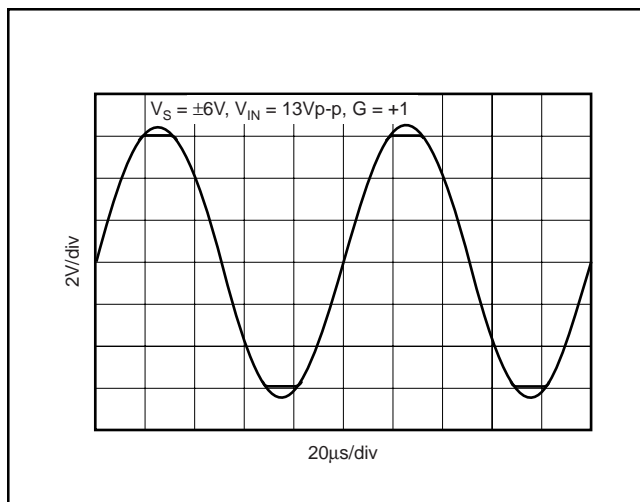

FIGURE 3. OPA743—No Phase Inversion with Inputs Greater than the Power-Supply Voltage.

RAIL-TO-RAIL OUTPUT

A class AB output stage with common-source transistors is used to achieve rail-to-rail output. This output stage is capable of driving 1k Ω loads connected to any point between $V+$ and $V-$. For light resistive loads ($> 100\text{k}\Omega$), the output voltage can swing to 100mV from the supply rail. With 1k Ω resistive loads, the output can swing to within 325mV from the supply rails while maintaining high open-loop gain (see the typical performance curve “Output Voltage Swing vs Output Current”).

CAPACITIVE LOAD AND STABILITY

The OPA743 series op amps can drive up to 1000pF pure capacitive load. Increasing the gain enhances the amplifier's ability to drive greater capacitive loads (see the typical performance curve "Small Signal Overshoot vs Capacitive Load").

One method of improving capacitive load drive in the unity-gain configuration is to insert a 10Ω to 20Ω resistor inside the feedback loop, as shown in Figure 4. This reduces ringing with large capacitive loads while maintaining DC accuracy.

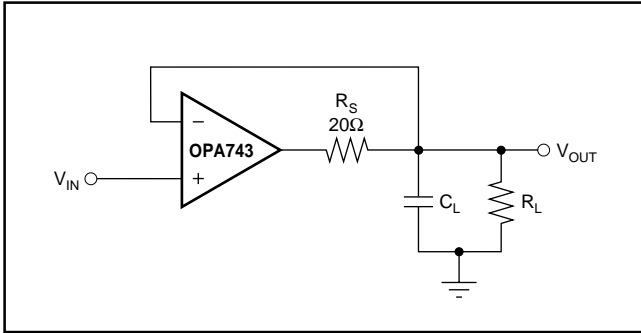

FIGURE 4. Series Resistor in Unity-Gain Buffer Configuration Improves Capacitive Load Drive.

APPLICATION CIRCUITS

The OPA743 series op amps are optimized for driving medium-speed sampling data converters. The OPA743 op amps buffer the converter's input capacitance and resulting charge injection while providing signal gain.

Figure 5 shows the OPA743 in a dual supply buffered reference configuration for the DAC7644.

REFERENCE BUFFER FOR LCD SOURCE DRIVERS

In modern high resolution TFT LCD displays, gamma correction must be performed to correct for nonlinearities in the glass transmission characteristics of the LCD panel. The typical LCD source driver for 64 Bits of Grayscale uses internal DAC to convert the 6-Bit data into analog voltages applied to the LCD. These DAC typically require external voltage references for proper operation. Normally these external reference voltages are generated using a simple resistive ladder, like the one shown in Figure 6.

Typical laptop or desktop LCD panels require 6 to 8 of the source driver circuits in parallel to drive all columns of the panel. Although the resistive load of one internal string DAC is only around 10kΩ, 6 to 8 in parallel represent a very substantial load. The power supply used for the LCD source drivers for laptops is typically in the order of 10V. To maximize the dynamic range of the DAC, rail-to-rail output performance is required for the upper and lower buffer. The OPA743's ability to operate on 12V supplies, to drive heavy resistive loads (as low as 1kΩ), and to swing to within 325mV of the supply rails, makes it very well suited as a buffer for the reference voltage inputs of LCD source drivers.

During conversion, the DAC's internal switches create current glitches on the output of the reference buffer. The capacitor C_L (typically 100nF) functions as a charge reservoir that provides/absorbs most of the glitch energy. The series resistor R_S isolates the outputs of the OPA743 from the heavy capacitive load and helps to improve settling time.

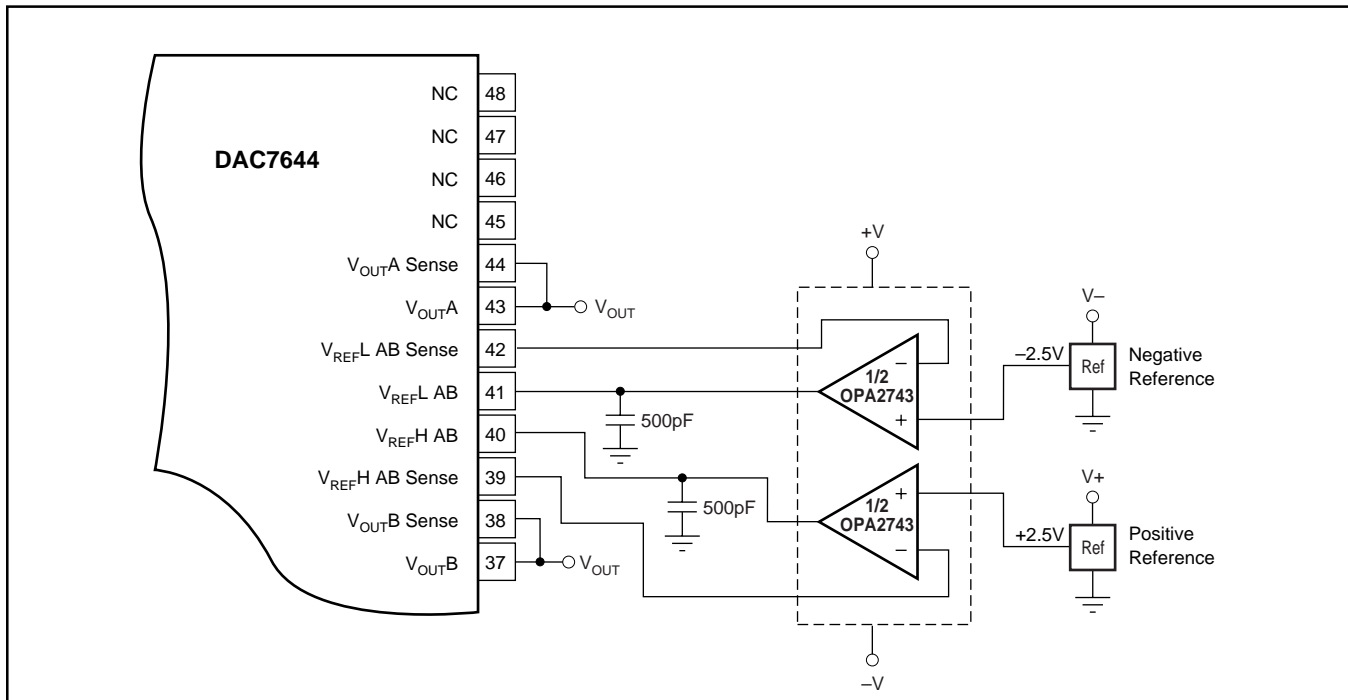

FIGURE 5. OPA743 as Dual Supply Configuration-Buffered References for the DAC7644.

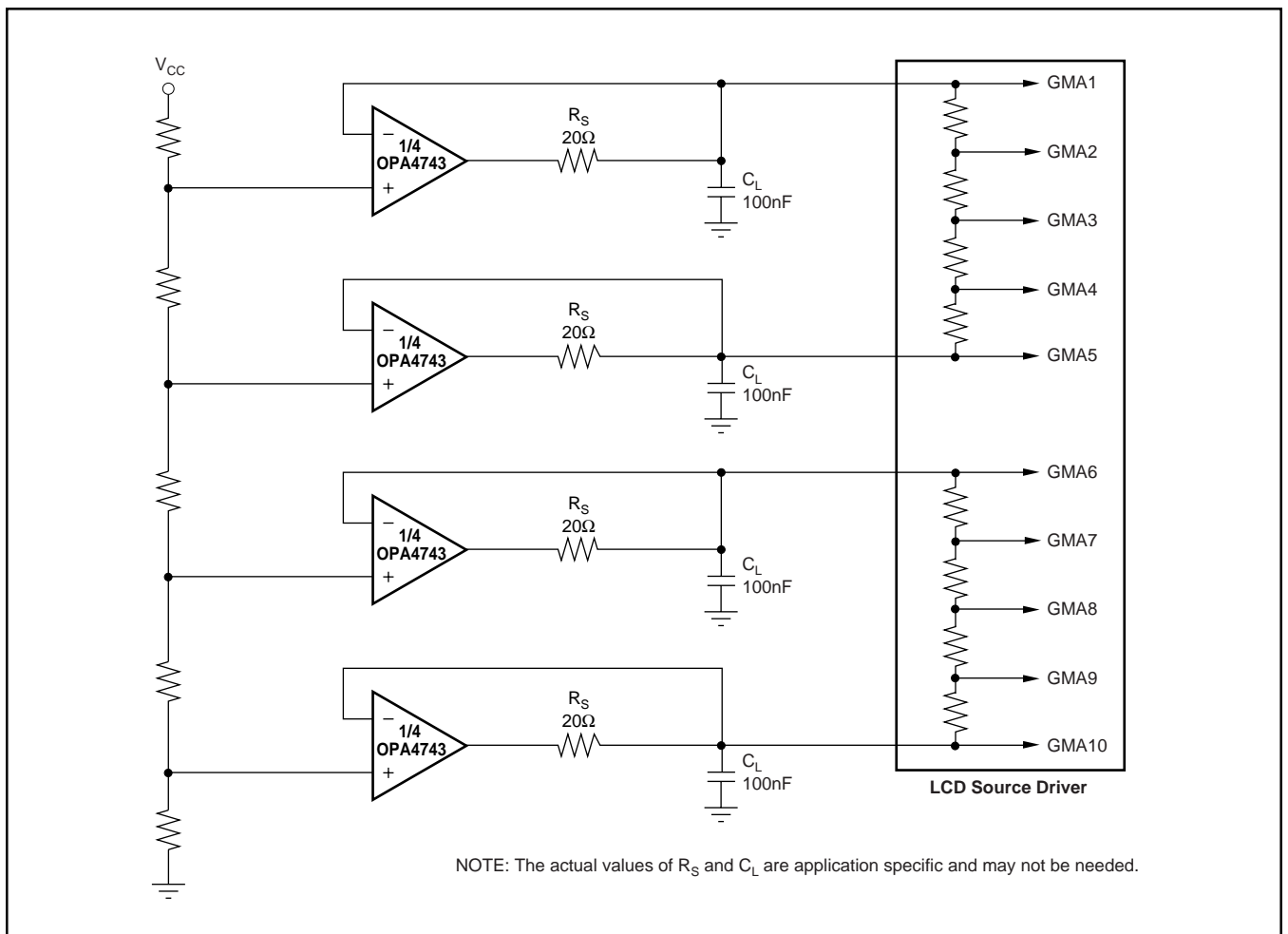

FIGURE 6. OPA743 Configured as a Reference Buffer for an LCD Display.

PACKAGING INFORMATION

Orderable part number	Status (1)	Material type (2)	Package Pins	Package qty Carrier	RoHS (3)	Lead finish/ Ball material (4)	MSL rating/ Peak reflow (5)	Op temp (°C)	Part marking (6)
OPA2743EA/250	Last Time Buy	Production	VSSOP (DGK) 8	250 SMALL T&R	Yes	Call TI Nipdauag Nipdau	Level-2-260C-1 YEAR	-40 to 85	E43
OPA2743EA/250.B	Last Time Buy	Production	VSSOP (DGK) 8	250 SMALL T&R	Yes	Call TI	Level-2-260C-1 YEAR	-40 to 85	E43
OPA2743EA/2K5	Active	Production	VSSOP (DGK) 8	2500 LARGE T&R	Yes	Call TI Nipdauag Nipdau	Level-2-260C-1 YEAR	-40 to 85	E43
OPA2743EA/2K5.B	Active	Production	VSSOP (DGK) 8	2500 LARGE T&R	Yes	NIPDAU	Level-2-260C-1 YEAR	-40 to 85	E43
OPA2743UA	Last Time Buy	Production	SOIC (D) 8	75 TUBE	Yes	NIPDAU	Level-2-260C-1 YEAR	-40 to 85	OPA 2743UA
OPA2743UA.B	Last Time Buy	Production	SOIC (D) 8	75 TUBE	Yes	NIPDAU	Level-2-260C-1 YEAR	-40 to 85	OPA 2743UA
OPA2743UA/2K5	Active	Production	SOIC (D) 8	2500 LARGE T&R	Yes	NIPDAU	Level-2-260C-1 YEAR	-40 to 85	OPA 2743UA
OPA2743UA/2K5.B	Active	Production	SOIC (D) 8	2500 LARGE T&R	Yes	NIPDAU	Level-2-260C-1 YEAR	-40 to 85	OPA 2743UA
OPA2743UA/2K5G4	Active	Production	SOIC (D) 8	2500 LARGE T&R	Yes	NIPDAU	Level-2-260C-1 YEAR	-40 to 85	OPA 2743UA
OPA2743UA/2K5G4.B	Active	Production	SOIC (D) 8	2500 LARGE T&R	Yes	NIPDAU	Level-2-260C-1 YEAR	-40 to 85	OPA 2743UA
OPA4743EA/250	Active	Production	TSSOP (PW) 14	250 SMALL T&R	Yes	NIPDAU	Level-2-260C-1 YEAR	-40 to 85	OPA 4743EA
OPA4743EA/250.B	Active	Production	TSSOP (PW) 14	250 SMALL T&R	Yes	NIPDAU	Level-2-260C-1 YEAR	-40 to 85	OPA 4743EA
OPA4743EA/2501G4	Active	Production	TSSOP (PW) 14	250 SMALL T&R	Yes	NIPDAU	Level-2-260C-1 YEAR	-40 to 85	OPA 4743EA
OPA4743EA/2501G4.B	Active	Production	TSSOP (PW) 14	250 SMALL T&R	Yes	NIPDAU	Level-2-260C-1 YEAR	-40 to 85	OPA 4743EA
OPA4743UA	Last Time Buy	Production	SOIC (D) 14	50 TUBE	Yes	NIPDAU	Level-1-260C-UNLIM	-40 to 85	OPA4743UA
OPA4743UA.B	Last Time Buy	Production	SOIC (D) 14	50 TUBE	Yes	NIPDAU	Level-1-260C-UNLIM	-40 to 85	OPA4743UA
OPA4743UA/2K5	Active	Production	SOIC (D) 14	2500 LARGE T&R	Yes	NIPDAU	Level-1-260C-UNLIM	-40 to 85	OPA4743UA
OPA4743UA/2K5.B	Active	Production	SOIC (D) 14	2500 LARGE T&R	Yes	NIPDAU	Level-1-260C-UNLIM	-40 to 85	OPA4743UA

Orderable part number	Status (1)	Material type (2)	Package Pins	Package qty Carrier	RoHS (3)	Lead finish/ Ball material (4)	MSL rating/ Peak reflow (5)	Op temp (°C)	Part marking (6)
OPA4743UAG4	Active	Production	SOIC (D) 14	50 TUBE	Yes	NIPDAU	Level-1-260C-UNLIM	-40 to 85	OPA4743UA
OPA4743UAG4.B	Active	Production	SOIC (D) 14	50 TUBE	Yes	NIPDAU	Level-1-260C-UNLIM	-40 to 85	OPA4743UA
OPA743NA/250	Last Time Buy	Production	SOT-23 (DBV) 5	250 SMALL T&R	Yes	NIPDAU	Level-2-260C-1 YEAR	-40 to 85	D43
OPA743NA/250.B	Last Time Buy	Production	SOT-23 (DBV) 5	250 SMALL T&R	Yes	NIPDAU	Level-2-260C-1 YEAR	-40 to 85	D43
OPA743NA/250G4	Last Time Buy	Production	SOT-23 (DBV) 5	250 SMALL T&R	Yes	NIPDAU	Level-2-260C-1 YEAR	-40 to 85	D43
OPA743NA/3K	Active	Production	SOT-23 (DBV) 5	3000 LARGE T&R	Yes	NIPDAU	Level-2-260C-1 YEAR	-40 to 85	D43
OPA743NA/3K.B	Active	Production	SOT-23 (DBV) 5	3000 LARGE T&R	Yes	NIPDAU	Level-2-260C-1 YEAR	-40 to 85	D43
OPA743NA/3KG4	Active	Production	SOT-23 (DBV) 5	3000 LARGE T&R	Yes	NIPDAU	Level-2-260C-1 YEAR	-40 to 85	D43
OPA743UA	Last Time Buy	Production	SOIC (D) 8	75 TUBE	Yes	NIPDAU	Level-2-260C-1 YEAR	-40 to 85	OPA 743UA
OPA743UA.B	Last Time Buy	Production	SOIC (D) 8	75 TUBE	Yes	NIPDAU	Level-2-260C-1 YEAR	-40 to 85	OPA 743UA
OPA743UAG4	Last Time Buy	Production	SOIC (D) 8	75 TUBE	Yes	NIPDAU	Level-2-260C-1 YEAR	-40 to 85	OPA 743UA

(1) **Status:** For more details on status, see our [product life cycle](#).

(2) **Material type:** When designated, preproduction parts are prototypes/experimental devices, and are not yet approved or released for full production. Testing and final process, including without limitation quality assurance, reliability performance testing, and/or process qualification, may not yet be complete, and this item is subject to further changes or possible discontinuation. If available for ordering, purchases will be subject to an additional waiver at checkout, and are intended for early internal evaluation purposes only. These items are sold without warranties of any kind.

(3) **RoHS values:** Yes, No, RoHS Exempt. See the [TI RoHS Statement](#) for additional information and value definition.

(4) **Lead finish/Ball material:** Parts may have multiple material finish options. Finish options are separated by a vertical ruled line. Lead finish/Ball material values may wrap to two lines if the finish value exceeds the maximum column width.

(5) **MSL rating/Peak reflow:** The moisture sensitivity level ratings and peak solder (reflow) temperatures. In the event that a part has multiple moisture sensitivity ratings, only the lowest level per JEDEC standards is shown. Refer to the shipping label for the actual reflow temperature that will be used to mount the part to the printed circuit board.

(6) **Part marking:** There may be an additional marking, which relates to the logo, the lot trace code information, or the environmental category of the part.

Multiple part markings will be inside parentheses. Only one part marking contained in parentheses and separated by a "~" will appear on a part. If a line is indented then it is a continuation of the previous line and the two combined represent the entire part marking for that device.

Important Information and Disclaimer: The information provided on this page represents TI's knowledge and belief as of the date that it is provided. TI bases its knowledge and belief on information provided by third parties, and makes no representation or warranty as to the accuracy of such information. Efforts are underway to better integrate information from third parties. TI has taken and continues to take reasonable steps to provide representative and accurate information but may not have conducted destructive testing or chemical analysis on incoming materials and chemicals. TI and TI suppliers consider certain information to be proprietary, and thus CAS numbers and other limited information may not be available for release.

In no event shall TI's liability arising out of such information exceed the total purchase price of the TI part(s) at issue in this document sold by TI to Customer on an annual basis.

TAPE AND REEL INFORMATION

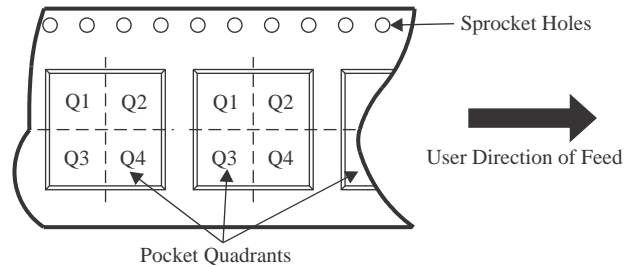
QUADRANT ASSIGNMENTS FOR PIN 1 ORIENTATION IN TAPE

*All dimensions are nominal

Device	Package Type	Package Drawing	Pins	SPQ	Reel Diameter (mm)	Reel Width W1 (mm)	A0 (mm)	B0 (mm)	K0 (mm)	P1 (mm)	W (mm)	Pin1 Quadrant
OPA2743EA/250	VSSOP	DGK	8	250	180.0	12.4	5.3	3.4	1.4	8.0	12.0	Q1
OPA2743EA/2K5	VSSOP	DGK	8	2500	330.0	12.4	5.3	3.4	1.4	8.0	12.0	Q1
OPA2743UA/2K5	SOIC	D	8	2500	330.0	12.4	6.4	5.2	2.1	8.0	12.0	Q1
OPA2743UA/2K5G4	SOIC	D	8	2500	330.0	12.4	6.4	5.2	2.1	8.0	12.0	Q1
OPA4743EA/250	TSSOP	PW	14	250	180.0	12.4	6.9	5.6	1.6	8.0	12.0	Q1
OPA4743EA/2501G4	TSSOP	PW	14	250	180.0	12.4	6.9	5.6	1.6	8.0	12.0	Q1
OPA4743UA/2K5	SOIC	D	14	2500	330.0	16.4	6.5	9.0	2.1	8.0	16.0	Q1
OPA743NA/250	SOT-23	DBV	5	250	178.0	9.0	3.3	3.2	1.4	4.0	8.0	Q3
OPA743NA/3K	SOT-23	DBV	5	3000	178.0	9.0	3.3	3.2	1.4	4.0	8.0	Q3

TAPE AND REEL BOX DIMENSIONS

*All dimensions are nominal

Device	Package Type	Package Drawing	Pins	SPQ	Length (mm)	Width (mm)	Height (mm)
OPA2743EA/250	VSSOP	DGK	8	250	213.0	191.0	35.0
OPA2743EA/2K5	VSSOP	DGK	8	2500	353.0	353.0	32.0
OPA2743UA/2K5	SOIC	D	8	2500	353.0	353.0	32.0
OPA2743UA/2K5G4	SOIC	D	8	2500	353.0	353.0	32.0
OPA4743EA/250	TSSOP	PW	14	250	213.0	191.0	35.0
OPA4743EA/2501G4	TSSOP	PW	14	250	213.0	191.0	35.0
OPA4743UA/2K5	SOIC	D	14	2500	353.0	353.0	32.0
OPA743NA/250	SOT-23	DBV	5	250	180.0	180.0	18.0
OPA743NA/3K	SOT-23	DBV	5	3000	180.0	180.0	18.0

TUBE

*All dimensions are nominal

Device	Package Name	Package Type	Pins	SPQ	L (mm)	W (mm)	T (μm)	B (mm)
OPA2743UA	D	SOIC	8	75	506.6	8	3940	4.32
OPA2743UA.B	D	SOIC	8	75	506.6	8	3940	4.32
OPA4743UA	D	SOIC	14	50	506.6	8	3940	4.32
OPA4743UA.B	D	SOIC	14	50	506.6	8	3940	4.32
OPA4743UAG4	D	SOIC	14	50	506.6	8	3940	4.32
OPA4743UAG4.B	D	SOIC	14	50	506.6	8	3940	4.32
OPA743UA	D	SOIC	8	75	506.6	8	3940	4.32
OPA743UA.B	D	SOIC	8	75	506.6	8	3940	4.32
OPA743UAG4	D	SOIC	8	75	506.6	8	3940	4.32

IMPORTANT NOTICE AND DISCLAIMER

TI PROVIDES TECHNICAL AND RELIABILITY DATA (INCLUDING DATASHEETS), DESIGN RESOURCES (INCLUDING REFERENCE DESIGNS), APPLICATION OR OTHER DESIGN ADVICE, WEB TOOLS, SAFETY INFORMATION, AND OTHER RESOURCES "AS IS" AND WITH ALL FAULTS, AND DISCLAIMS ALL WARRANTIES, EXPRESS AND IMPLIED, INCLUDING WITHOUT LIMITATION ANY IMPLIED WARRANTIES OF MERCHANTABILITY, FITNESS FOR A PARTICULAR PURPOSE OR NON-INFRINGEMENT OF THIRD PARTY INTELLECTUAL PROPERTY RIGHTS.

These resources are intended for skilled developers designing with TI products. You are solely responsible for (1) selecting the appropriate TI products for your application, (2) designing, validating and testing your application, and (3) ensuring your application meets applicable standards, and any other safety, security, regulatory or other requirements.

These resources are subject to change without notice. TI grants you permission to use these resources only for development of an application that uses the TI products described in the resource. Other reproduction and display of these resources is prohibited. No license is granted to any other TI intellectual property right or to any third party intellectual property right. TI disclaims responsibility for, and you fully indemnify TI and its representatives against any claims, damages, costs, losses, and liabilities arising out of your use of these resources.

TI's products are provided subject to [TI's Terms of Sale](#), [TI's General Quality Guidelines](#), or other applicable terms available either on [ti.com](#) or provided in conjunction with such TI products. TI's provision of these resources does not expand or otherwise alter TI's applicable warranties or warranty disclaimers for TI products. Unless TI explicitly designates a product as custom or customer-specified, TI products are standard, catalog, general purpose devices.

TI objects to and rejects any additional or different terms you may propose.

Copyright © 2026, Texas Instruments Incorporated

Last updated 10/2025