

TLC2274-HT Advanced LinCMOS™ Rail-to-Rail Operational Amplifier

1 Features

- Qualified for Automotive Applications
- Qualified in Accordance With AEC-Q100
- Output Swing Includes Both Supply Rails
- Low Noise: $9 \text{ nV}/\sqrt{\text{Hz}}$ Typ at $f = 1 \text{ kHz}$
- Low Input Bias Current: 1 pA Typical
- Fully Specified for Both Single-Supply and Split-Supply Operation
- Common-Mode Input Voltage Range Includes Negative Rail
- High-Gain Bandwidth: 2.2 MHz Typical
- High Slew Rate: $3.6 \text{ V}/\mu\text{s}$ Typical
- Low Input Offset Voltage $2500\text{-}\mu\text{V}$ Max at $T_A = 25^\circ\text{C}$
- Macromodel Included

2 Applications

- Supports Extreme Temperature Applications:
 - Controlled Baseline
 - One Assembly and Test Site
 - One Fabrication Site
 - Available in Extreme (-40°C to 150°C) Temperature Range ⁽¹⁾
 - Extended Product Life Cycle
 - Extended Product-Change Notification
 - Product Traceability
 - Texas Instruments' high temperature products use highly-optimized silicon (die) solutions with design and process enhancements to maximize performance over extended temperatures. All devices are characterized and qualified for 1000 hours continuous operating life at maximum rated temperature.

(1) Custom temperature ranges available

3 Description

The TLC2274 is a quadruple operational amplifier from Texas Instruments. The device exhibits rail-to-rail output performance for increased dynamic range in single- or split-supply applications. The TLC2274 offers 2 MHz of bandwidth and $3 \text{ V}/\mu\text{s}$ of slew rate for higher speed applications. This device offers comparable ac performance while having better noise, input offset voltage, and power dissipation than existing CMOS operational amplifiers. The TLC2274 has a noise voltage of $9 \text{ nV}/\sqrt{\text{Hz}}$, two times lower than competitive solutions.

The TLC2274, exhibiting high input impedance and low noise, is excellent for small-signal conditioning for high-impedance sources, such as piezoelectric transducers. Because of the micropower dissipation levels, this device works well in hand-held monitoring and remote-sensing applications. In addition, the rail-to-rail output feature, with single- or split-supplies, makes this device a great choice when interfacing with analog-to-digital converters (ADCs). This family is fully characterized at 5 V and $\pm 5 \text{ V}$.

It offers increased output dynamic range, lower noise voltage, and lower input offset voltage. This enhanced feature set allows the device to be used in a wider range of applications.

Device Information⁽¹⁾

PART NUMBER	PACKAGE	BODY SIZE (NOM)
TLC2274-HT	TSSOP (14)	6.60 mm x 5.10 mm

(1) For all available packages, see the orderable addendum at the end of the data sheet.

Maximum Peak-to-Peak Output Voltage vs Supply Voltage

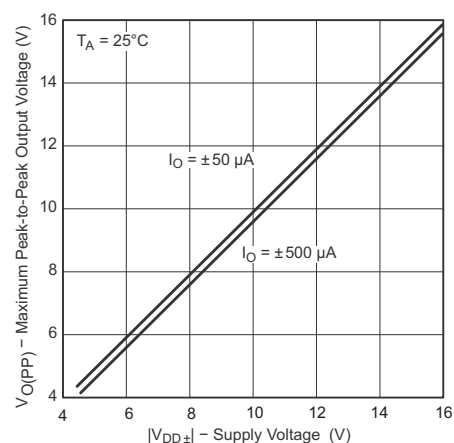

Table of Contents

1 Features	1	7.1 Overview	17
2 Applications	1	7.2 Functional Block Diagram	17
3 Description	1	7.3 Feature Description	17
4 Revision History	2	8 Application and Implementation	18
5 Pin Configuration and Functions	3	8.1 Application Information	18
6 Specifications	4	8.2 Typical Application	19
6.1 Absolute Maximum Ratings	4	9 Power Supply Recommendations	22
6.2 ESD Ratings	4	10 Layout	22
6.3 Recommended Operating Conditions	4	10.1 Layout Guidelines	22
6.4 Thermal Information	4	10.2 Layout Example	22
6.5 Electrical Characteristics, $V_{DD} = 5\text{ V}$	5	11 Device and Documentation Support	23
6.6 Operating Characteristics, $V_{DD} = 5\text{ V}$	6	11.1 Trademarks	23
6.7 Electrical Characteristics, $V_{DD\pm} = \pm 5\text{ V}$	7	11.2 Electrostatic Discharge Caution	23
6.8 Operating Characteristics, $V_{DD\pm} = \pm 5\text{ V}$	8	11.3 Glossary	23
6.9 Typical Characteristics	10	12 Mechanical, Packaging, and Orderable Information	23
7 Detailed Description	17		

4 Revision History

DATE	REVISION	NOTES
January 2015	*	Initial release.

5 Pin Configuration and Functions

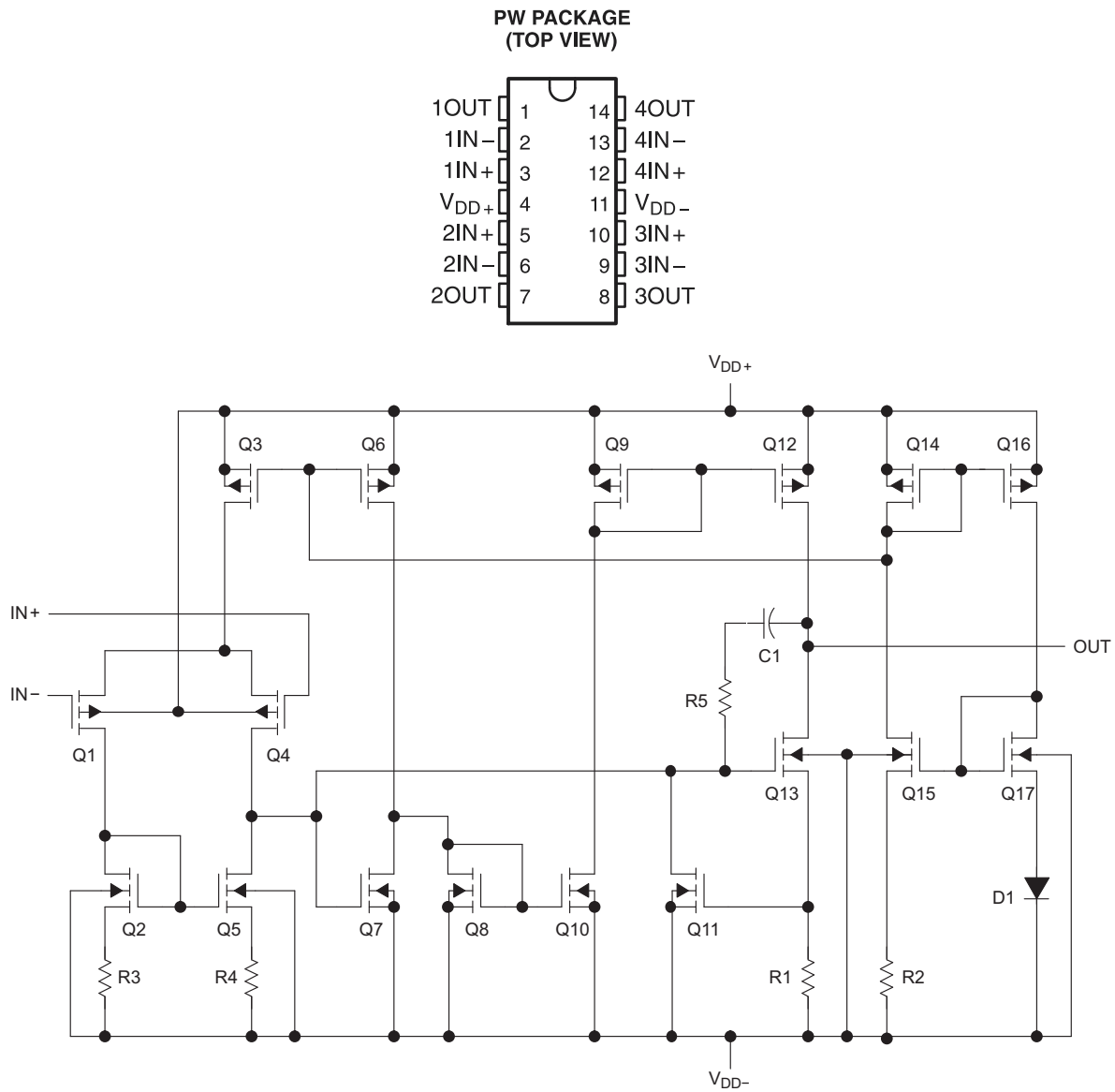

Figure 1. Equivalent Schematic (Each Amplifier)

Table 1. Actual Device Component Count⁽¹⁾

COMPONENT	TLC2274
Transistors	76
Resistors	52
Diodes	18
Capacitors	6

(1) Includes both amplifiers and all ESD, bias, and trim circuitry

6 Specifications

6.1 Absolute Maximum Ratings⁽¹⁾

over operating free-air temperature range (unless otherwise noted)

		MIN	MAX	UNIT	
V _{DD+}	Supply voltage ⁽²⁾		8	V	
V _{DD-}	Supply voltage ⁽²⁾		-8	V	
V _{ID}	Differential input voltage ⁽³⁾	-16	16	V	
V _I	Input voltage ⁽²⁾	Any input	V _{DD-} - 0.3	V _{DD+}	V
I _I	Input current	Any input	-5	5	mA
I _O	Output current		-50	50	mA
	Total current into V _{DD+}		-50	50	mA
	Total current out of V _{DD-}		-50	50	mA
	Duration of short-circuit current at (or below) 25°C ⁽⁴⁾		Unlimited		
T _A	Operating free-air temperature	-40	150	°C	
	Lead temperature 1.6 mm (1/16 inch) from case for 10 s		260	°C	
T _{stg}	Storage temperature	-65	150	°C	

- (1) Stresses beyond those listed under “absolute maximum ratings” may cause permanent damage to the device. These are stress ratings only, and functional operation of the device at these or any other conditions beyond those indicated under “recommended operating conditions” is not implied. Exposure to absolute-maximum-rated conditions for extended periods may affect device reliability.
- (2) All voltage values, except differential voltages, are with respect to the midpoint between V_{DD+} and V_{DD-}.
- (3) Differential voltages are at I_{N+} with respect to I_{N-}. Excessive current will flow if input is brought below V_{DD-} - 0.3 V.
- (4) The output may be shorted to either supply. Temperature and/or supply voltages must be limited to ensure that the maximum dissipation rating is not exceeded.

6.2 ESD Ratings

			VALUE	UNIT
V _(ESD)	Electrostatic discharge	Human-body model (HBM), per AEC Q100-002 ⁽¹⁾	±2500	V
		Charged-device model (CDM), per AEC Q100-011	All pins	

- (1) AEC Q100-002 indicates that HBM stressing shall be in accordance with the ANSI/ESDA/JEDEC JS-001 specification.

6.3 Recommended Operating Conditions

over operating free-air temperature range (unless otherwise noted)

		MIN	MAX	UNIT
V _{DD±}	Supply voltage	±2.2	±8	V
V _I	Input voltage	V _{DD-}	V _{DD+} - 1.5	V
V _{IC}	Common-mode input voltage	V _{DD-}	V _{DD+} - 1.5	V
T _A	Operating free-air temperature	-40	150	°C

6.4 Thermal Information

THERMAL METRIC ⁽¹⁾		TLC2274	UNIT
		PW	
		14 PINS	
R _{θJA}	Junction-to-ambient thermal resistance	106.0	°C/W
R _{θJC(top)}	Junction-to-case (top) thermal resistance	35.5	
R _{θJB}	Junction-to-board thermal resistance	47.6	
Ψ _{JT}	Junction-to-top characterization parameter	2.4	
Ψ _{JB}	Junction-to-board characterization parameter	47.1	

- (1) For more information about traditional and new thermal metrics, see the *IC Package Thermal Metrics* application report, [SPRA953](#).

6.5 Electrical Characteristics, $V_{DD} = 5\text{ V}$

at specified free-air temperature, $V_{DD} = 5\text{ V}$ (unless otherwise noted)

PARAMETER		TEST CONDITIONS		T_A ⁽¹⁾	MIN	TYP	MAX	UNIT	
V_{IO}	Input offset voltage			25°C		300	2500	μV	
				Full range			3000		
αV_{IO}	Temperature coefficient of input offset voltage			25°C to 125°C		2		$\mu\text{V}/^\circ\text{C}$	
	Input offset voltage long-term drift ⁽²⁾	$V_{IC} = 0\text{ V},$ $V_O = 0\text{ V},$	$V_{DD\pm} = \pm 2.5\text{ V},$ $R_S = 50\ \Omega$	25°C		0.002		$\mu\text{V}/\text{mo}$	
I_{IO}	Input offset current			25°C		0.5	60	pA	
				Full range			7000		
I_{IB}	Input bias current			25°C		1		pA	
				Full range					
V_{ICR}	Common-mode input voltage range	$R_S = 50\ \Omega$	$ V_{IO} \leq 5\text{ mV}$	25°C	0 to 4	-0.3 to 4.2		V	
				Full range	0 to 3.5				
V_{OH}	High-level output voltage			25°C		4.99		V	
				25°C	Full range	$I_{OH} = -20\ \mu\text{A}$	4.85		4.93
						$I_{OH} = -200\ \mu\text{A}$	4.84		
				25°C	Full range	$I_{OH} = -1\text{ mA}$	4.25		4.65
$I_{OH} = -1\text{ mA}$	4.20								
V_{OL}	Low-level output voltage			25°C		0.01		V	
				25°C	Full range	$V_{IC} = 2.5\text{ V},$ $I_{OL} = 50\ \mu\text{A}$	0.09		0.15
						$V_{IC} = 2.5\text{ V},$ $I_{OL} = 500\ \mu\text{A}$			0.16
				25°C	Full range	$V_{IC} = 2.5\text{ V},$ $I_{OL} = 5\text{ mA}$	0.9		1.5
$V_{IC} = 2.5\text{ V},$ $I_{OL} = 5\text{ mA}$		1.6							
A_{VD}	Large-signal differential voltage amplification	$V_{IC} = 2.5\text{ V},$ $V_O = 1\text{ V to }4\text{ V},$		25°C	Full range	$R_L = 10\text{ k}\Omega$ ⁽³⁾	10	35	V/mV
						$R_L = 1\text{ M}\Omega$ ⁽³⁾	175		
				25°C	Full range		8		
r_{id}	Differential input resistance			25°C		10^{12}		Ω	
r_i	Common-mode input resistance			25°C		10^{12}		Ω	
C_i	Common-mode input capacitance	$f = 10\text{ kHz},$	N package	25°C		8		pF	
Z_o	Closed-loop output impedance	$f = 1\text{ MHz},$	$A_V = 10$	25°C		140		Ω	
CMRR	Common-mode rejection ratio	$V_{IC} = 0\text{ V to }2.7\text{ V},$ $V_O = 2.5\text{ V},$		25°C	70	75		dB	
				Full range	69				
k_{SVR}	Supply voltage rejection ratio ($\Delta V_{DD}/\Delta V_{IO}$)	$V_{DD} = 4.4\text{ V to }16\text{ V},$ $V_{IC} = V_{DD}/2,$		25°C	80	95		dB	
				Full range	80				
I_{DD}	Supply current	$V_O = 2.5\text{ V},$		25°C		4.4	6	mA	
				Full range			6		

(1) Full range is -40°C to 150°C for this part.

(2) Typical values are based on the input offset voltage shift observed through 168 hours of operating life test at $T_A = 150^\circ\text{C}$ extrapolated to $T_A = 25^\circ\text{C}$ using the Arrhenius equation and assuming an activation energy of 0.96 eV.

(3) Referenced to 2.5 V

6.6 Operating Characteristics, $V_{DD} = 5\text{ V}$

 at specified free-air temperature, $V_{DD} = 5\text{ V}$ (unless otherwise noted)

PARAMETER		TEST CONDITIONS		$T_A^{(1)}$	MIN	TYP	MAX	UNIT
SR	Slew rate at unity gain	$V_O = 0.5\text{ V to } 2.5\text{ V}, R_L = 10\text{ k}\Omega^{(2)}$ $C_L = 100\text{ pF}^{(2)}$		25°C	2.3	3.6		V/ μs
				Full range	1.2			
V_n	Equivalent input noise voltage	$f = 10\text{ Hz}$ $f = 1\text{ kHz}$		25°C	50			nV/ $\sqrt{\text{Hz}}$
				25°C	9			
$V_{N(pp)}$	Peak-to-peak equivalent input noise voltage	$f = 0.1\text{ to } 1\text{ Hz}$ $f = 0.1\text{ to } 10\text{ Hz}$		25°C	1			μV
				25°C	1.4			
I_n	Equivalent input noise current			25°C	0.6			fA/ $\sqrt{\text{Hz}}$
THD + N	Total harmonic distortion plus noise	$V_O = 0.5\text{ V to } 2.5\text{ V}, R_L = 10\text{ k}\Omega, f = 20\text{ kHz}^{(2)}$		25°C	$A_V = 1$		0.0013%	
					$A_V = 10$		0.004%	
					$A_V = 100$		0.03%	
Gain-bandwidth product		$f = 10\text{ kHz}, C_L = 100\text{ pF}^{(2)}$	$R_L = 10\text{ k}\Omega^{(2)}$	25°C	2.18			MHz
B_{OM}	Maximum output-swing bandwidth	$V_{O(pp)} = 2\text{ V}, R_L = 10\text{ k}\Omega^{(2)}$	$A_V = 1, C_L = 100\text{ pF}^{(2)}$	25°C	1			MHz
t_s	Settling time	$A_V = -1, \text{ Step} = 0.5\text{ V to } 2.5\text{ V}, R_L = 10\text{ k}\Omega^{(2)}, C_L = 100\text{ pF}^{(2)}$		25°C	To 0.1%		1.5	μs
					To 0.01%		2.6	
ϕ_m	Phase margin at unity gain	$R_L = 10\text{ k}\Omega, C_L = 100\text{ pF}^{(2)}$		25°C	50°			
	Gain margin			25°C	10			dB

 (1) Full range is -40°C to 150°C for this part.

(2) Referenced to 2.5 V

6.7 Electrical Characteristics, $V_{DD\pm} = \pm 5\text{ V}$

at specified free-air temperature, $V_{DD\pm} = \pm 5\text{ V}$ (unless otherwise noted)

PARAMETER		TEST CONDITIONS		$T_A^{(1)}$	MIN	TYP	MAX	UNIT		
V_{IO}	Input offset voltage	$V_{IC} = 0\text{ V},$ $R_S = 50\ \Omega$ $V_O = 0\text{ V}$		25°C		300	2500	μV		
				Full range			3000			
αV_{IO}	Temperature coefficient of input offset voltage			25°C to 125°C		2		$\mu\text{V}/^\circ\text{C}$		
	Input offset voltage long-term drift ⁽²⁾			25°C		0.002		$\mu\text{V}/\text{mo}$		
I_{IO}	Input offset current	$V_{IC} = 0\text{ V},$ $R_S = 50\ \Omega$ $V_O = 0\text{ V}$		25°C		0.5	60	pA		
				Full range			7000			
I_{IB}	Input bias current			$V_{IC} = 0\text{ V},$ $R_S = 50\ \Omega$ $V_O = 0\text{ V}$		25°C		1	60	pA
						Full range			7000	
V_{ICR}	Common-mode input voltage range	$R_S = 50\ \Omega$	$ V_{IO} \leq 5\text{ mV}$			25°C	-5 to 4	-5.3 to 4.2	V	
						Full range	-5 to 3.5			
V_{OM+}	Maximum positive peak output voltage	$V_{IC} = 0\text{ V},$ $I_O = -20\ \mu\text{A}$		25°C		4.99	V			
				25°C	4.85	4.93				
				Full range	4.84					
				25°C	4.25	4.65				
V_{OM-}	Maximum negative peak output voltage	$V_{IC} = 0\text{ V},$ $I_O = -1\text{ mA}$		25°C	-4.99		V			
				25°C	-4.85	-4.91				
				Full range	-4.85					
				25°C	-3.5	-4.1				
A_{VD}	Large-signal differential voltage amplification	$V_O = \pm 4\text{ V},$	$R_L = 10\text{ k}\Omega$	25°C	20	50	V/mV			
				Full range	16					
		$R_L = 1\text{ M}\Omega$	25°C		300					
			Full range							
r_{id}	Differential input resistance			25°C		10^{12}	Ω			
r_i	Common-mode input resistance			25°C		10^{12}	Ω			
c_i	Common-mode input capacitance	$f = 10\text{ kHz},$	N package	25°C		8	pF			
z_o	Closed-loop output impedance	$f = 1\text{ MHz},$	$AV = 10$	25°C		130	Ω			
CMRR	Common-mode rejection ratio	$V_{IC} = -5\text{ V to } 2.7\text{ V},$ $V_O = 0\text{ V},$	$R_S = 50\ \Omega$	25°C	75	80	dB			
				Full range	73					
k_{SVR}	Supply voltage rejection ratio ($\Delta V_{DD}/\Delta V_{IO}$)	$V_{DD} = \pm 2.2\text{ V to } \pm 8\text{ V},$ $V_{IC} = 0\text{ V},$	No load	25°C	80	95	dB			
				Full range	80					
I_{DD}	Supply current	$V_O = 0\text{ V},$	No load	25°C		4.4	6	mA		
				Full range			6			

(1) Full range is -40°C to 150°C for this part.

(2) Typical values are based on the input offset voltage shift observed through 168 hours of operating life test at $T_A = 150^\circ\text{C}$ extrapolated to $T_A = 25^\circ\text{C}$ using the Arrhenius equation and assuming an activation energy of 0.96 eV.

6.8 Operating Characteristics, $V_{DD\pm} = \pm 5\text{ V}$

at specified free-air temperature, $V_{DD\pm} = \pm 5\text{ V}$ (unless otherwise noted)

PARAMETER	TEST CONDITIONS	$T_A^{(1)}$	MIN	TYP	MAX	UNIT
SR	Slew rate at unity gain $V_O = \pm 2.3\text{ V}$, $R_L = 10\text{ k}\Omega$	$C_L = 100\text{ pF}$	25°C	2.3	3.6	V/ μs
			Full range	1.2		
V_n	Equivalent input noise voltage	$f = 10\text{ Hz}$	25°C	50		nV/ $\sqrt{\text{Hz}}$
		$f = 1\text{ kHz}$	25°C	9		
$V_{N(pp)}$	Peak-to-peak equivalent input noise voltage	$f = 0.1\text{ to }1\text{ Hz}$	25°C	1		μV
		$f = 0.1\text{ to }10\text{ Hz}$	25°C	1.4		
I_n	Equivalent input noise current		25°C	0.6		fA/ $\sqrt{\text{Hz}}$
THD + N	Total harmonic distortion plus noise $V_O = \pm 2.3\text{ V}$, $f = 20\text{ kHz}$, $R_L = 10\text{ k}\Omega$	$A_V = 1$	25°C	0.0011%		
		$A_V = 10$		0.004%		
		$A_V = 100$		0.03%		
	Gain-bandwidth product	$f = 10\text{ kHz}$, $C_L = 100\text{ pF}$	$R_L = 10\text{ k}\Omega$	25°C	2.25	MHz
B_{OM}	Maximum output-swing bandwidth	$V_{O(pp)} = 4.6\text{ V}$, $R_L = 10\text{ k}\Omega$	$A_V = 1$, $C_L = 100\text{ pF}$	25°C	0.54	MHz
t_s	Settling time	$A_V = -1$, Step = $-2.3\text{ V to }2.3\text{ V}$, $R_L = 10\text{ k}\Omega$, $C_L = 100\text{ pF}$	To 0.1%	25°C	1.5	μs
			To 0.01%		3.2	
Φ_m	Phase margin at unity gain	$R_L = 10\text{ k}\Omega$, $C_L = 100\text{ pF}$	25°C	52°		
	Gain margin		25°C	10		dB

(1) Full range is -40°C to 150°C for this part.

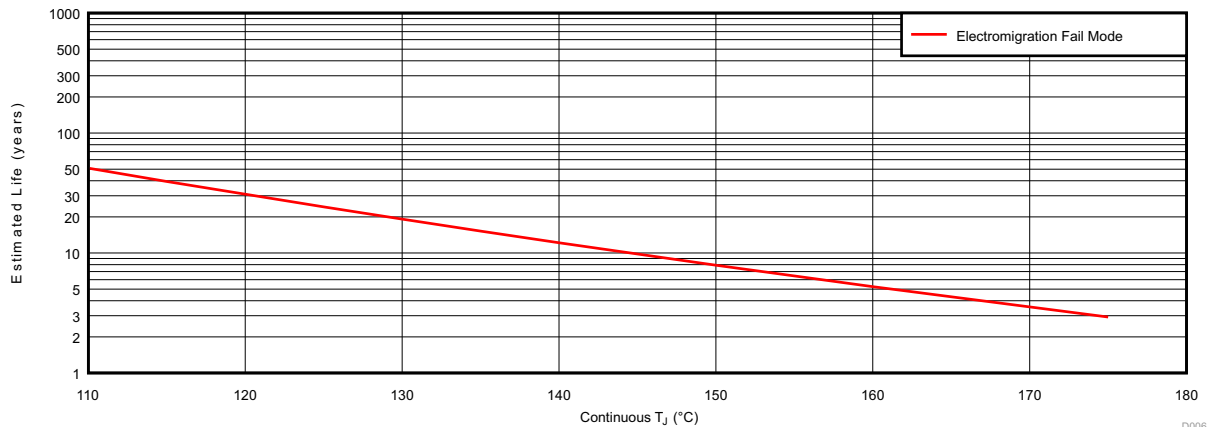

- A. See data sheet for *Absolute Maximum Ratings* and minimum *Recommended Operating Conditions*.
- B. Silicon operating life design goal is 10 years at 105°C junction temperature (does not include package interconnect life).

Figure 2. TLC2274EPWRQ1 Operating Life Derating Chart

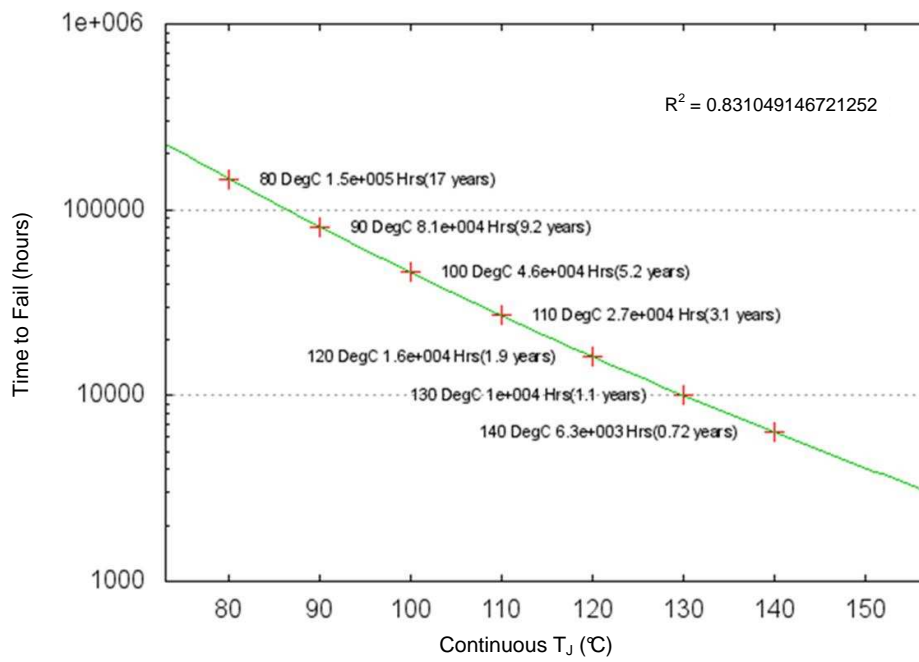

Figure 3. Estimated Wire Bond Life

6.9 Typical Characteristics

Data at high and low temperatures are applicable only within the rated operating free-air temperature ranges of the devices.

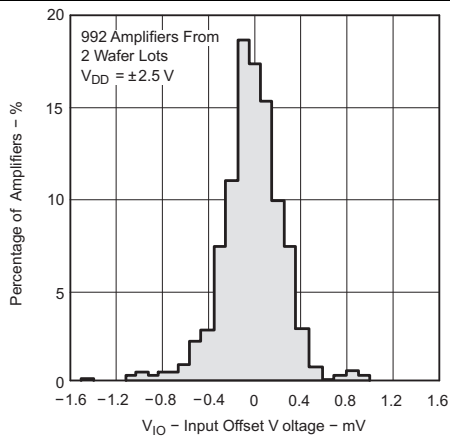

Figure 4. Distribution of TLC2274 Input Offset Voltage

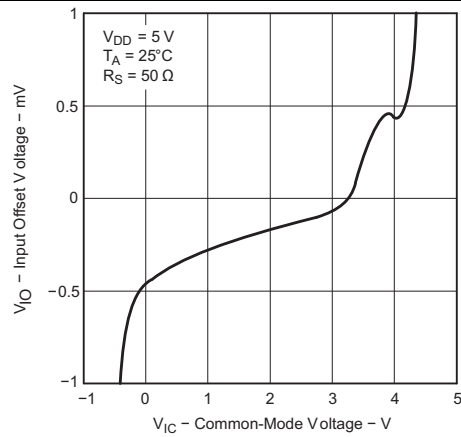

Figure 5. Input Offset Voltage vs Common-Mode Voltage

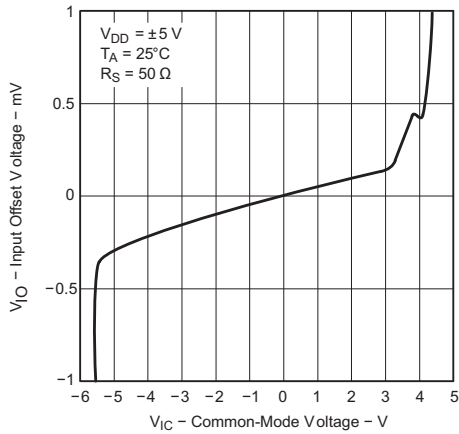

Figure 6. Input Offset Voltage vs Common-Mode Voltage

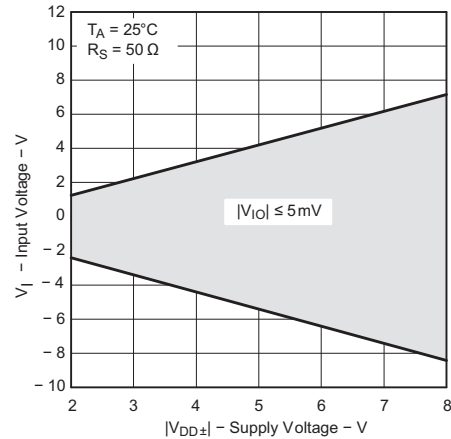

Figure 7. Input Voltage vs Supply Voltage

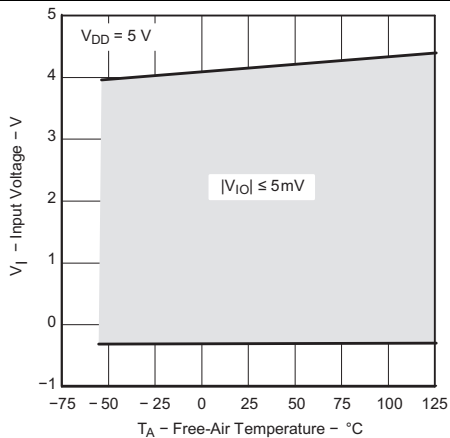

Figure 8. Input Voltage vs Free-Air Temperature

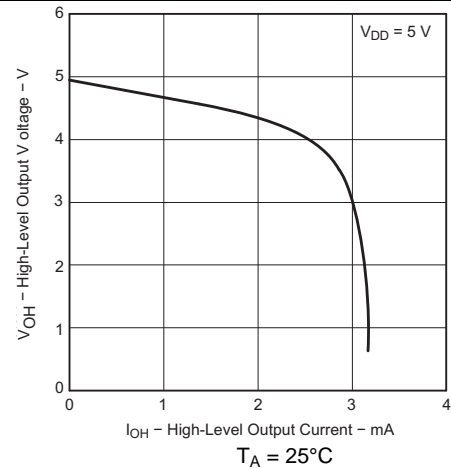

Figure 9. High-Level Output Voltage vs High-Level Output Current

Typical Characteristics (continued)

Data at high and low temperatures are applicable only within the rated operating free-air temperature ranges of the devices.

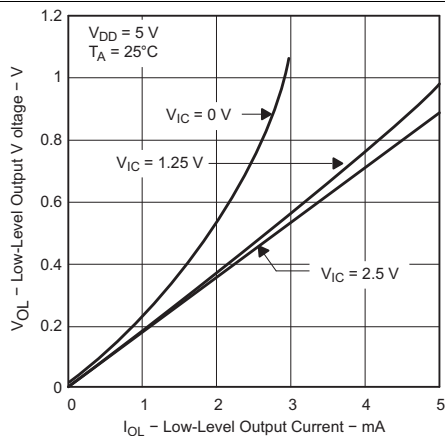

Figure 10. Low-Level Output Voltage vs Low-Level Output Current

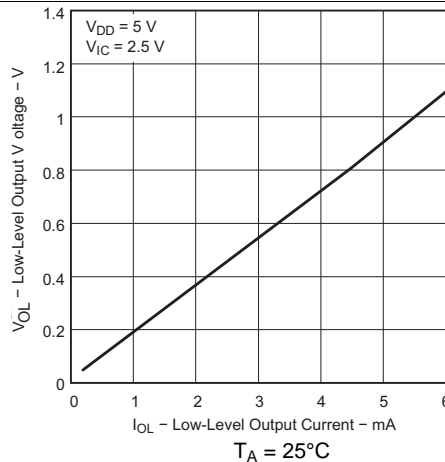

Figure 11. Low-Level Output Voltage vs Low-Level Output Current

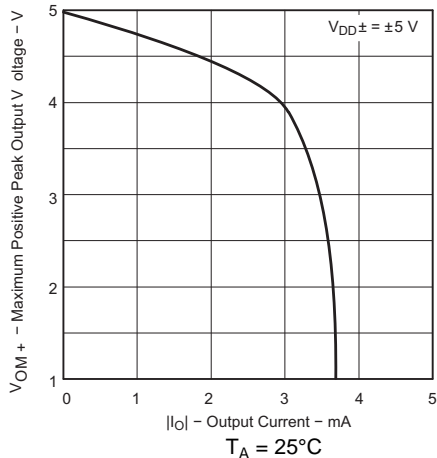

Figure 12. Maximum Positive Peak Output Voltage vs Output Current

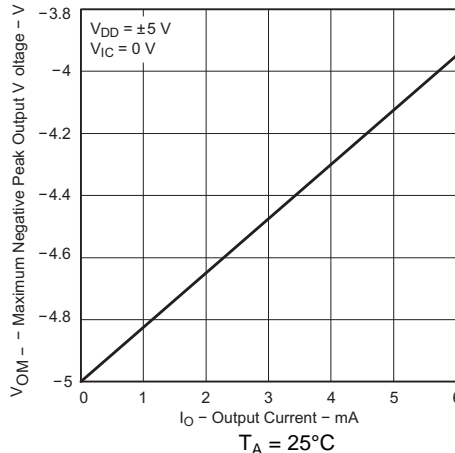

Figure 13. Maximum Negative Peak Output Voltage vs Output Current

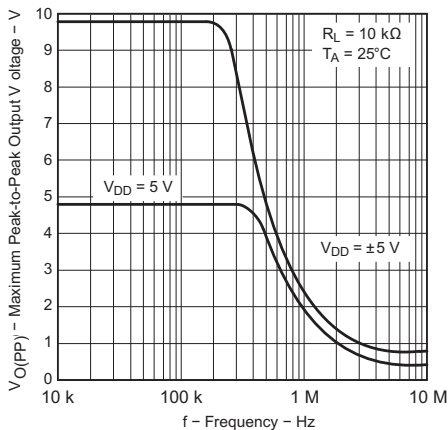

Figure 14. Maximum Peak-to-Peak Output Voltage vs Frequency

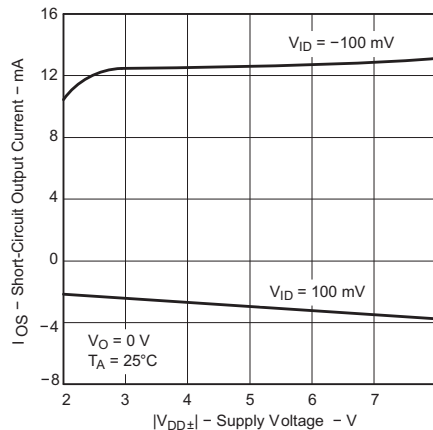

Figure 15. Short-Circuit Output Current vs Supply Voltage

Typical Characteristics (continued)

Data at high and low temperatures are applicable only within the rated operating free-air temperature ranges of the devices.

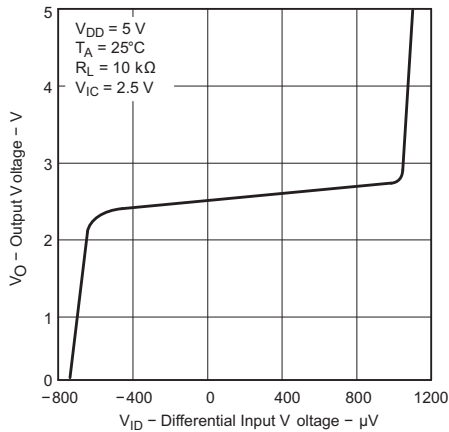

Figure 16. Output Voltage vs Differential Input Voltage

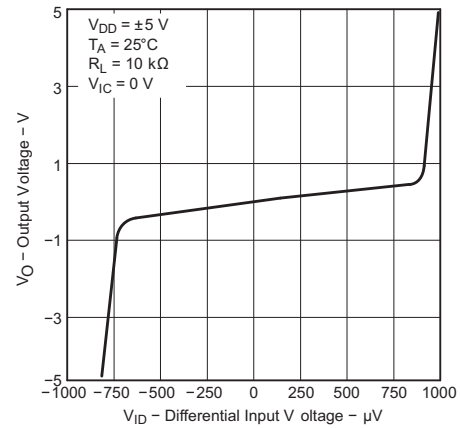

Figure 17. Output Voltage vs Differential Input Voltage

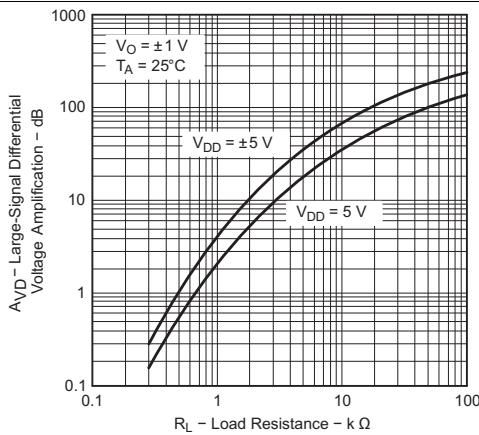

Figure 18. Large-Signal Differential Voltage Amplification vs Load Resistance

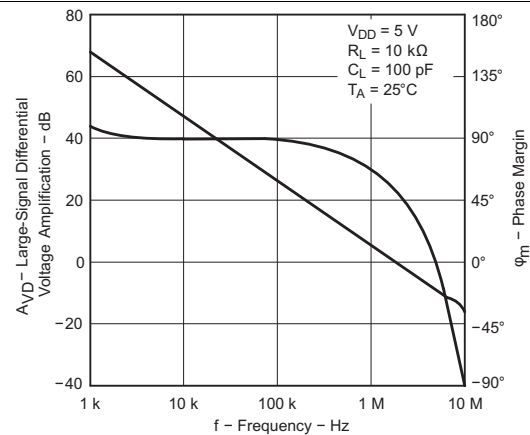

Figure 19. Large-Signal Differential Voltage Amplification and Phase Margin vs Frequency

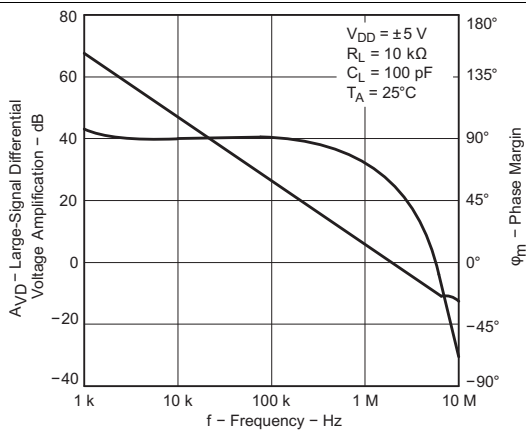

Figure 20. Large-Signal Differential Voltage Amplification and Phase Margin vs Frequency

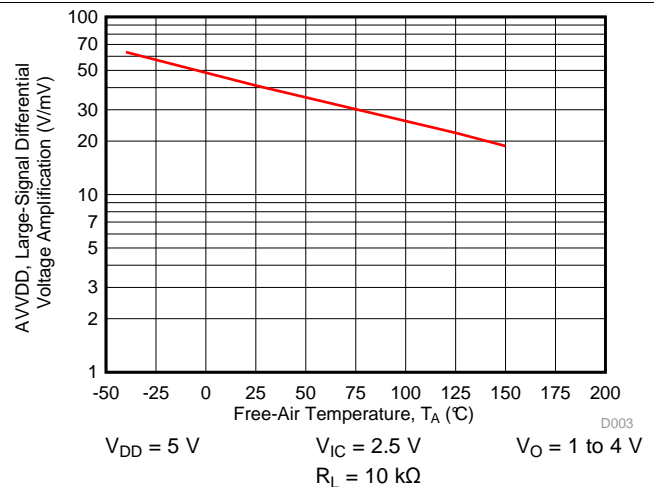

Figure 21. Large-Signal Differential Voltage Amplification vs Free-Air Temperature

Typical Characteristics (continued)

Data at high and low temperatures are applicable only within the rated operating free-air temperature ranges of the devices.

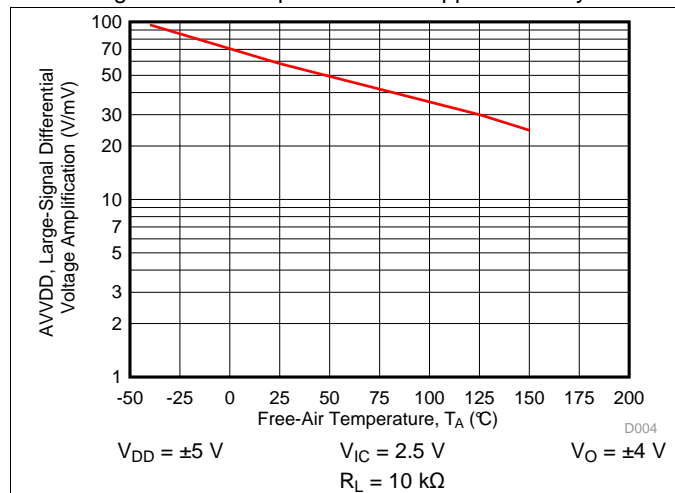

Figure 22. Large-Signal Differential Voltage Amplification vs Free-Air Temperature

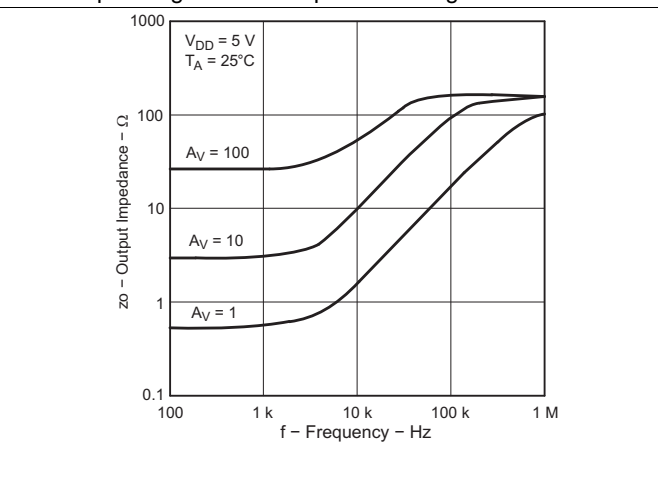

Figure 23. Output Impedance vs Frequency

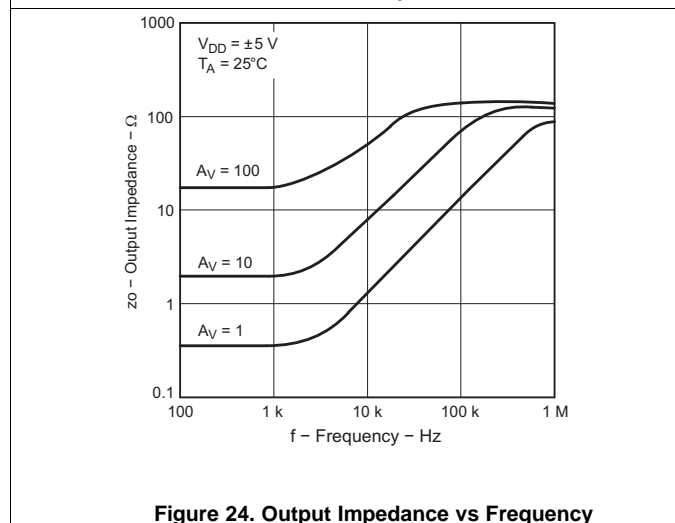

Figure 24. Output Impedance vs Frequency

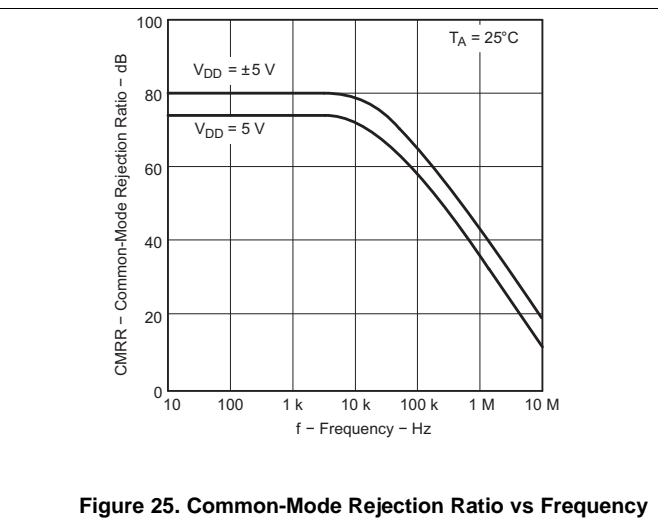

Figure 25. Common-Mode Rejection Ratio vs Frequency

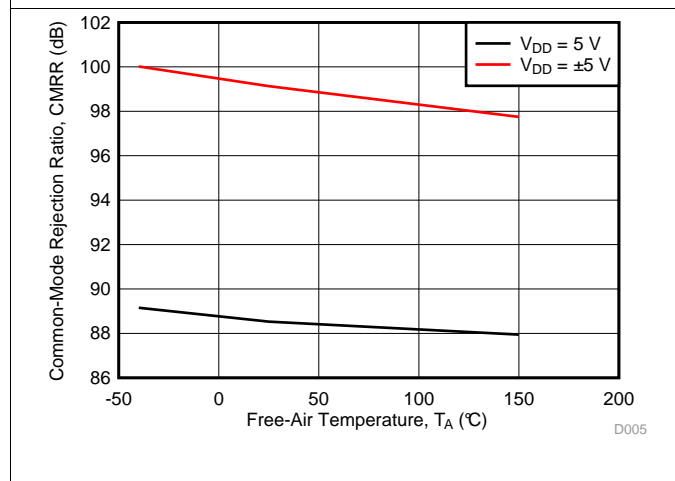

Figure 26. Common-Mode Rejection Ratio vs Free-Air Temperature

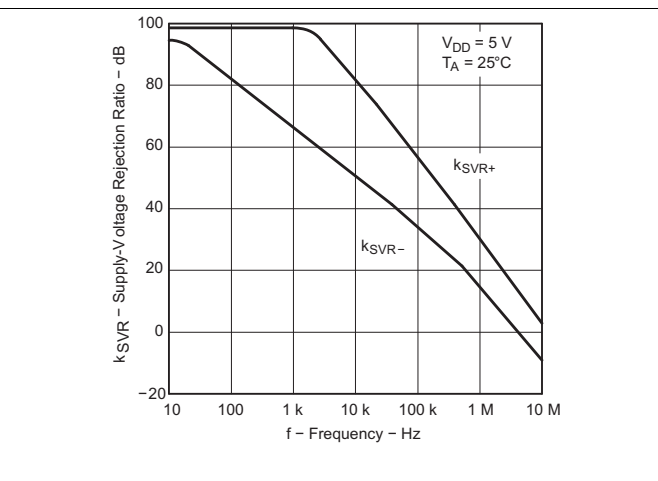

Figure 27. Supply-Voltage Rejection Ratio vs Frequency

Typical Characteristics (continued)

Data at high and low temperatures are applicable only within the rated operating free-air temperature ranges of the devices.

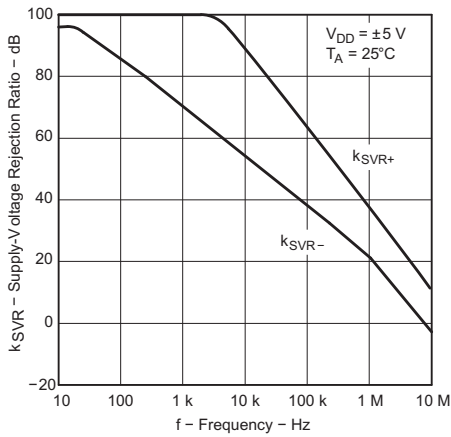

Figure 28. Supply-Voltage Rejection Ratio vs Frequency

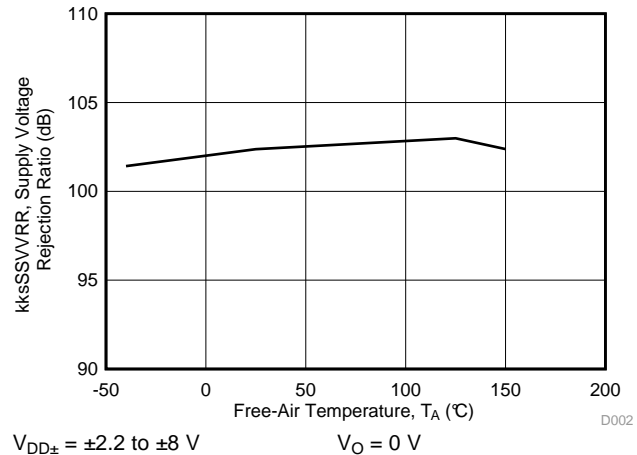

Figure 29. Supply-Voltage Rejection Ratio vs Free-Air Temperature

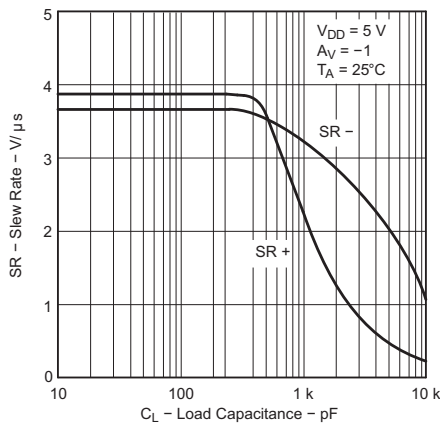

Figure 30. Slew Rate vs Load Capacitance

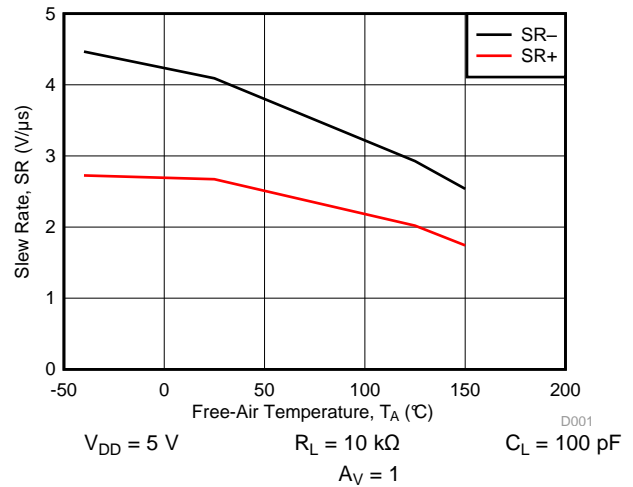

Figure 31. Slew Rate vs Free-Air Temperature

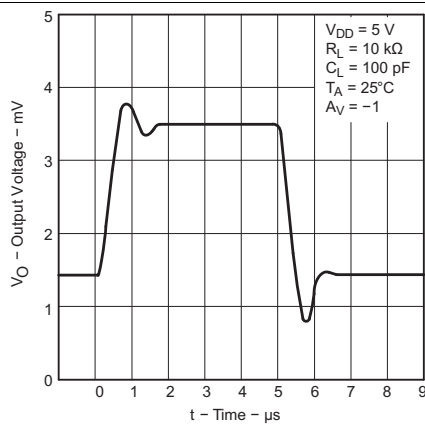

Figure 32. Inverting Large-Signal Pulse Response

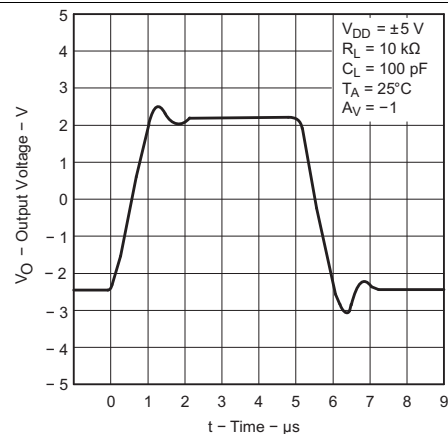

Figure 33. Inverting Large-Signal Pulse Response

Typical Characteristics (continued)

Data at high and low temperatures are applicable only within the rated operating free-air temperature ranges of the devices.

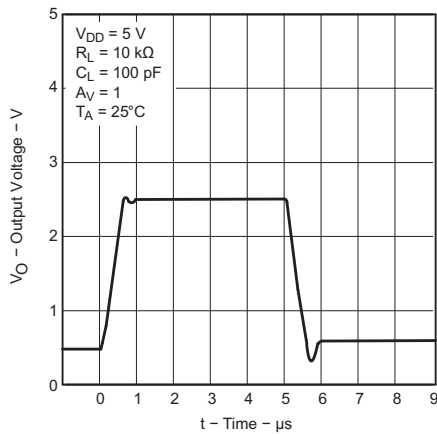

Figure 34. Voltage-Follower Large-Signal Pulse Response

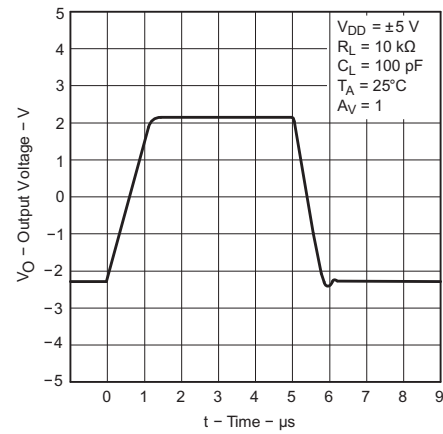

Figure 35. Voltage-Follower Large-Signal Pulse Response

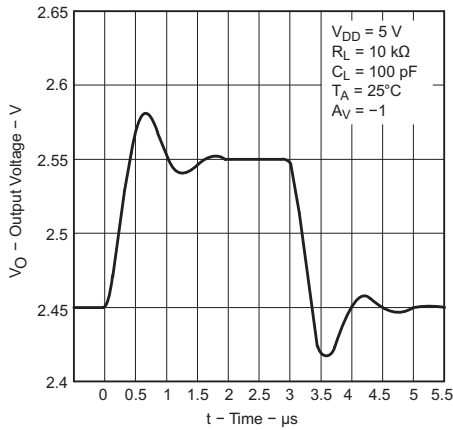

Figure 36. Inverting Small-Signal Pulse Response

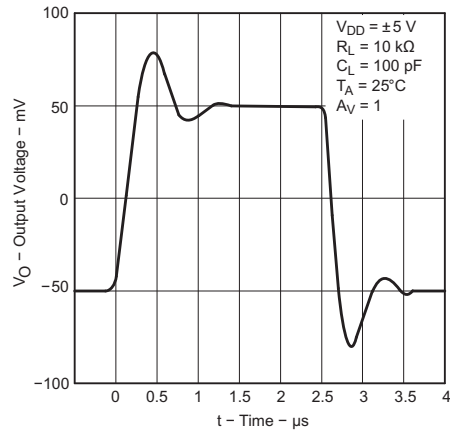

Figure 37. Inverting Small-Signal Pulse Response

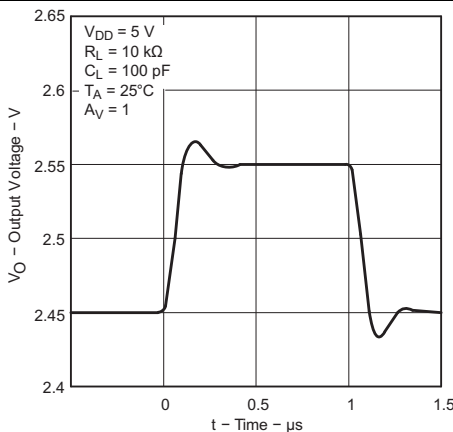

Figure 38. Voltage-Follower Small-Signal Pulse Response

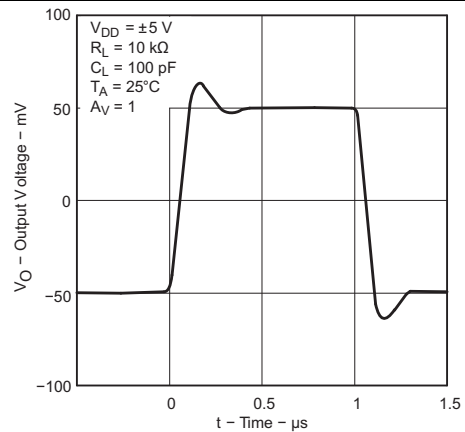

Figure 39. Voltage-Follower Small-Signal Pulse Response

Typical Characteristics (continued)

Data at high and low temperatures are applicable only within the rated operating free-air temperature ranges of the devices.

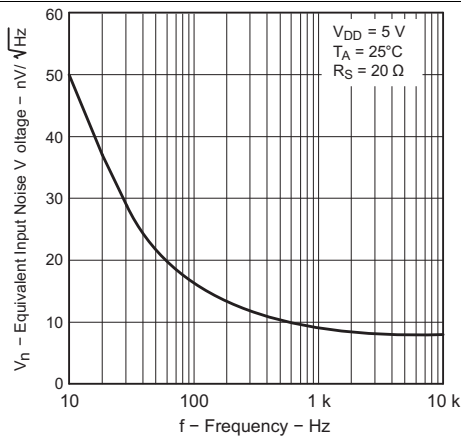

Figure 40. Equivalent Input Noise Voltage vs Frequency

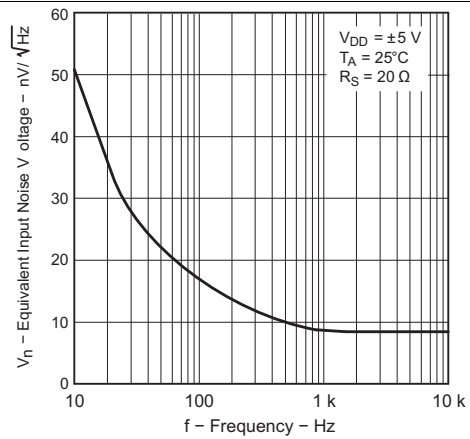

Figure 41. Equivalent Input Noise Voltage vs Frequency

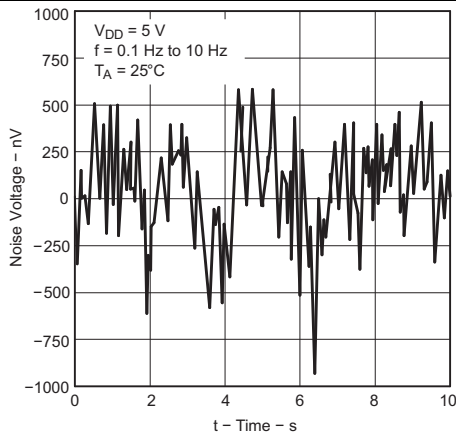

Figure 42. Noise Voltage Over a 10-s Period

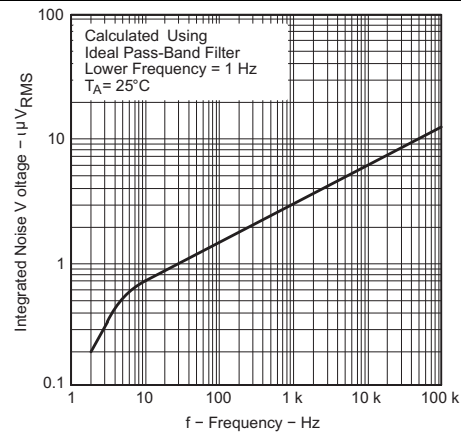

Figure 43. Integrated Noise Voltage vs Frequency

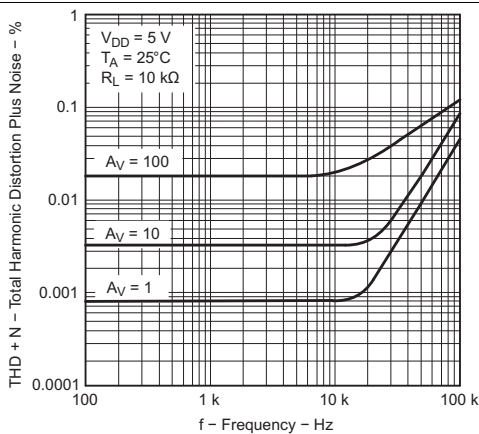

Figure 44. Total Harmonic Distortion Plus Noise vs Frequency

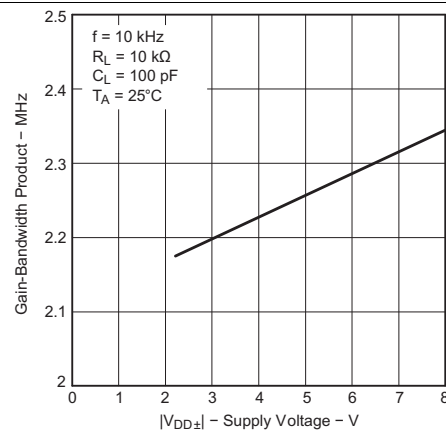

Figure 45. Gain-Bandwidth Product vs Supply Voltage

7 Detailed Description

7.1 Overview

The TLC2274 device exhibits rail-to-rail output performance for increased dynamic range in single- or split - supply applications. These device offers comparable ac performance while having better noise, input offset voltage and power dissipation than existing CMOS operational amplifiers. The TLC2274 device, exhibiting high input impedance and low noise, is excellent for small signal conditioning for high-impedance sources, such as piezoelectric transducers. It offers increased output dynamic range, lower noise voltage, and lower input offset voltage. This enhanced feature set allows the device to be used in a wider range of applications.

7.2 Functional Block Diagram

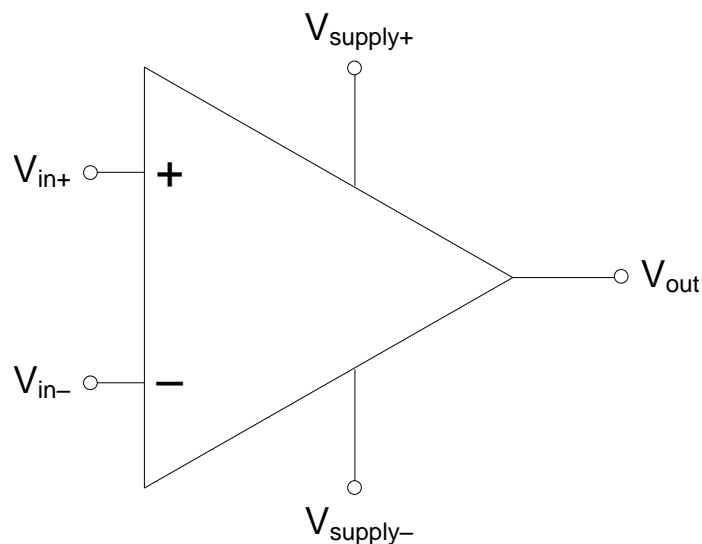

7.3 Feature Description

These devices use the Texas Instruments silicon gate LinCMOS™ process, giving them stable input offset voltages, very high input impedances, and extremely low input offset and bias currents. In addition, the rail-to-rail output feature with single- or split-supplies, makes this device a great choice when interfacing with analog-to-digital converters (ADCs).

8 Application and Implementation

NOTE

Information in the following applications sections is not part of the TI component specification, and TI does not warrant its accuracy or completeness. TI's customers are responsible for determining suitability of components for their purposes. Customers should validate and test their design implementation to confirm system functionality.

8.1 Application Information

8.1.1 Macromodel Information

Macromodel information provided was derived using Microsim Parts, the model generation software used with Microsim PSpice. The Boyle macromodel ⁽¹⁾ and subcircuit in [Figure 46](#) are generated using the TLC227x typical electrical and operating characteristics at $T_A = 25^\circ\text{C}$. Using this information, output simulations of the following key parameters can be generated to a tolerance of 20% (in most cases):

- Maximum positive output voltage swing
- Maximum negative output voltage swing
- Slew rate
- Quiescent power dissipation
- Input bias current
- Open-loop voltage amplification
- Unity-gain frequency
- Common-mode rejection ratio
- Phase margin
- DC output resistance
- AC output resistance
- Short-circuit output current limit

(1) G. R. Boyle, B. M. Cohn, D. O. Pederson, and J. E. Solomon, "Macromodeling of Integrated Circuit Operational Amplifiers", IEEE Journal of Solid-State Circuits, SC-9, 353 (1974).

Application Information (continued)

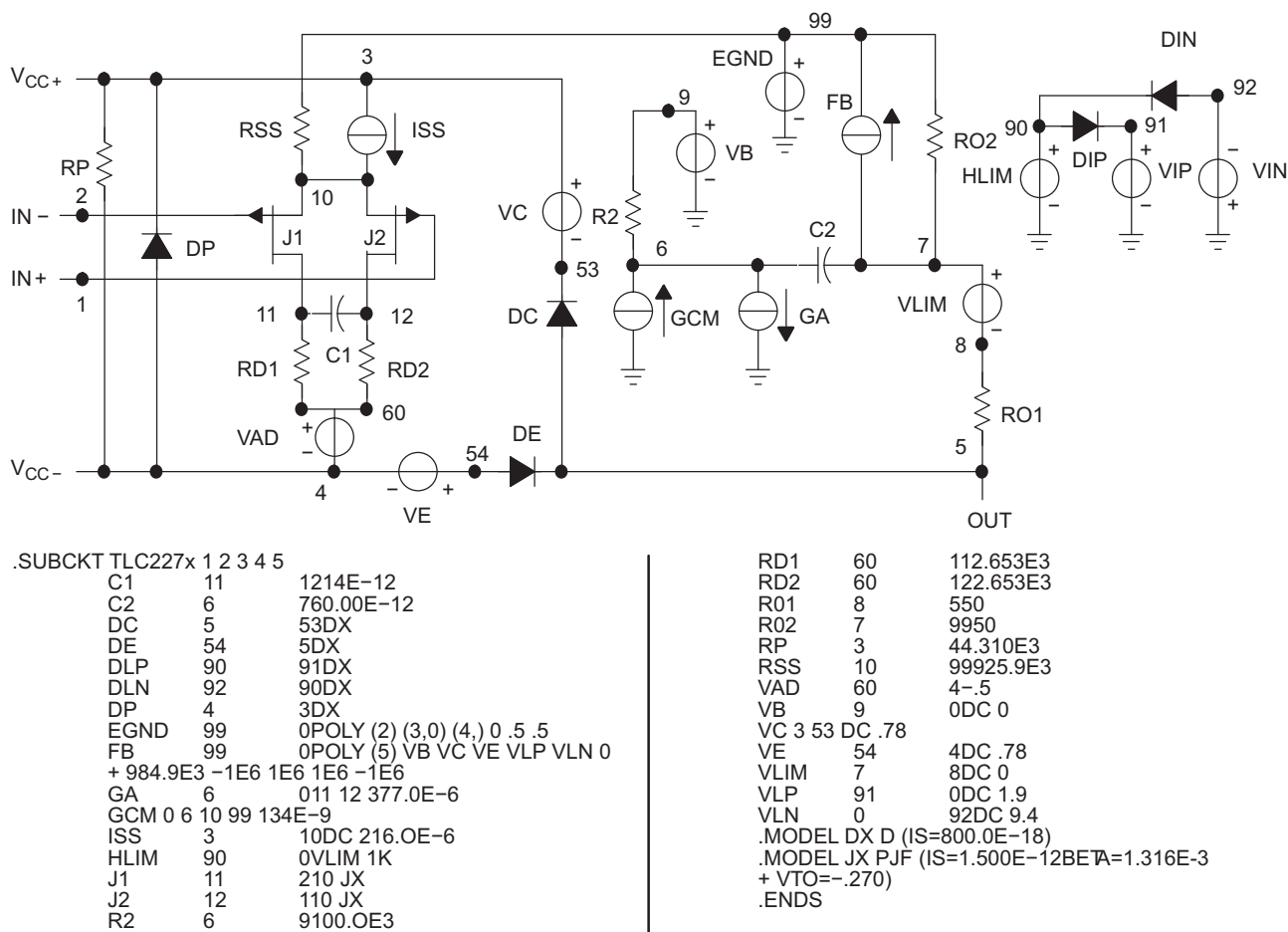

Figure 46. Boyle Macromodels and Subcircuit

8.2 Typical Application

The TLC2274 is designed to drive larger capacitive loads than most CMOS operational amplifiers. Figure 48 and Figure 49 show its ability to drive loads up to 1000 pF while maintaining good gain and phase margins (Rnull = 0).

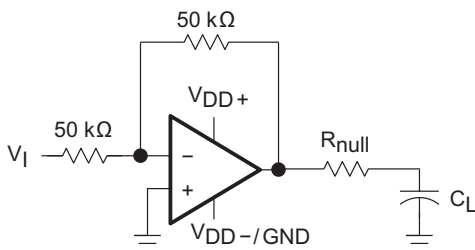

Figure 47. Typical Application Schematic

Typical Application (continued)

8.2.1 Design Requirements

As per Equation 1:

Table 2. Design Parameters

Improvement in Phase Margin	UGBW (kHz)	R null (Ω)	CL (pF)
0	1000	0	1000
7.15	1000	20	1000
17.43	1000	50	1000
32.12	1000	100	1000

8.2.2 Detailed Design Procedure

A smaller series resistor (R_{null}) at the output of the device (see Figure 47) improves the gain and phase margins when driving large capacitive loads. Figure 48 and Figure 49 show the effects of adding series resistances of 10 Ω, 50 Ω, 100 Ω, 200 Ω, and 500 Ω. The addition of this series resistor has two effects: the first is that it adds a zero to the transfer function and the second is that it reduces the frequency of the pole associated with the output load in the transfer function.

The zero introduced to the transfer function is equal to the series resistance times the load capacitance. To calculate the improvement in phase margin, Equation 1 can be used.

$$\Delta\phi_{m1} = \tan^{-1} (2 \times \pi \times \text{UGBW} \times R_{null} \times C_L)$$

where

- $\Delta\phi_{m1}$ = Improvement in phase margin
- UGBW = Unity-gain bandwidth frequency
- R_{null} = Output series resistance
- C_L = Load capacitance

(1)

The unity-gain bandwidth (UGBW) frequency decreases as the capacitive load increases (see Figure 47). To use equation 1, UGBW must be approximated from Figure 47. Using Equation 1 alone overestimates the improvement in phase margin, as illustrated in Figure 51. The overestimation is caused by the decrease in the frequency of the pole associated with the load, thus providing additional phase shift and reducing the overall improvement in phase margin. Using Figure 47, with Equation 1 enables the designer to choose the appropriate output series resistance to optimize the design of circuits driving large capacitance loads.

8.2.3 Application Curves

$T_A = 25^\circ\text{C}$

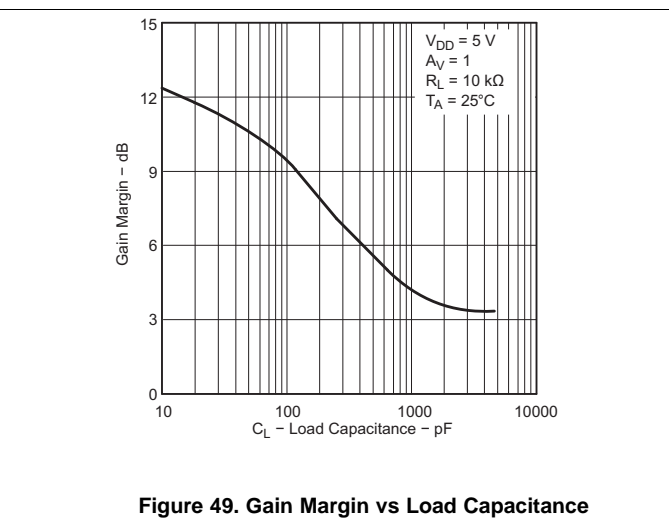
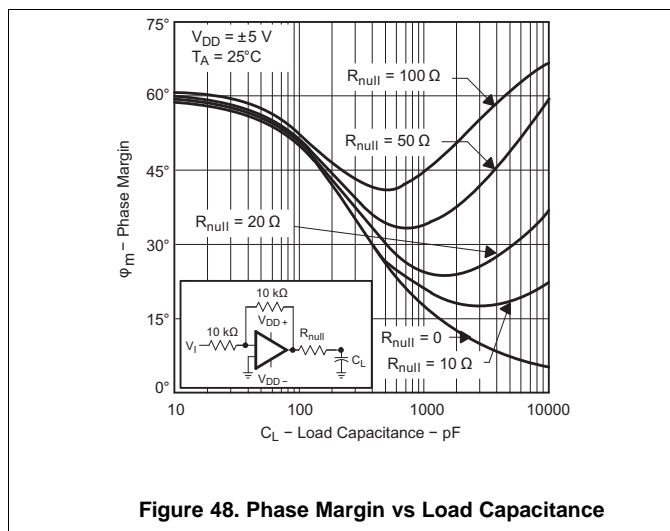

$T_A = 25^\circ\text{C}$

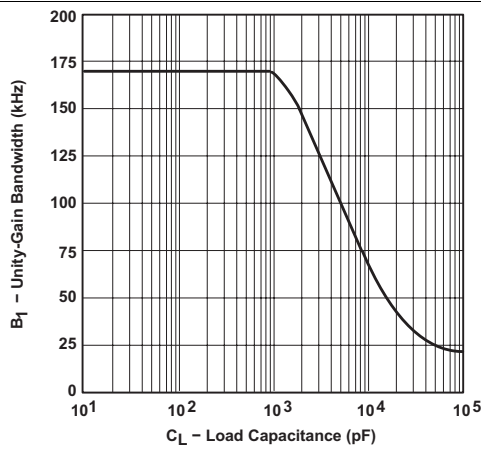

Figure 50. Unity-Gain Bandwidth vs Load Capacitance

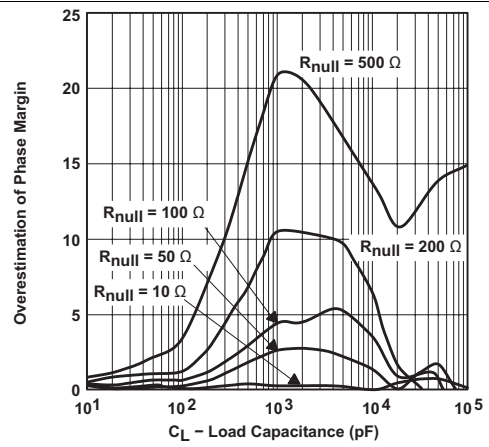

Figure 51. Overestimation of Phase Margin vs Load Capacitance

9 Power Supply Recommendations

TLC2274 operates from ± 2.2 - to ± 8 -V. In addition, key parameters are assured over the specified temperature range, -55°C to 125°C . Parameters which vary significantly with operating voltage or temperature are shown in the *Typical Characteristics*.

10 Layout

10.1 Layout Guidelines

The TLC2274 has very-low offset voltage and drift. To achieve highest performance, optimize circuit layout and mechanical conditions. Offset voltage and drift can be degraded by small thermoelectric potentials at the operational amplifier inputs. Connections of dissimilar metals generate thermal potential, which can degrade the ultimate performance of the TLC2274. Cancel these thermal potentials by assuring that they are equal in both input terminals.

- Keep the thermal mass of the connections made to the two input terminals similar.
- Locate heat sources as far as possible from the critical input circuitry.
- Shield operational amplifier and input circuitry from air currents such as cooling fans.

10.2 Layout Example

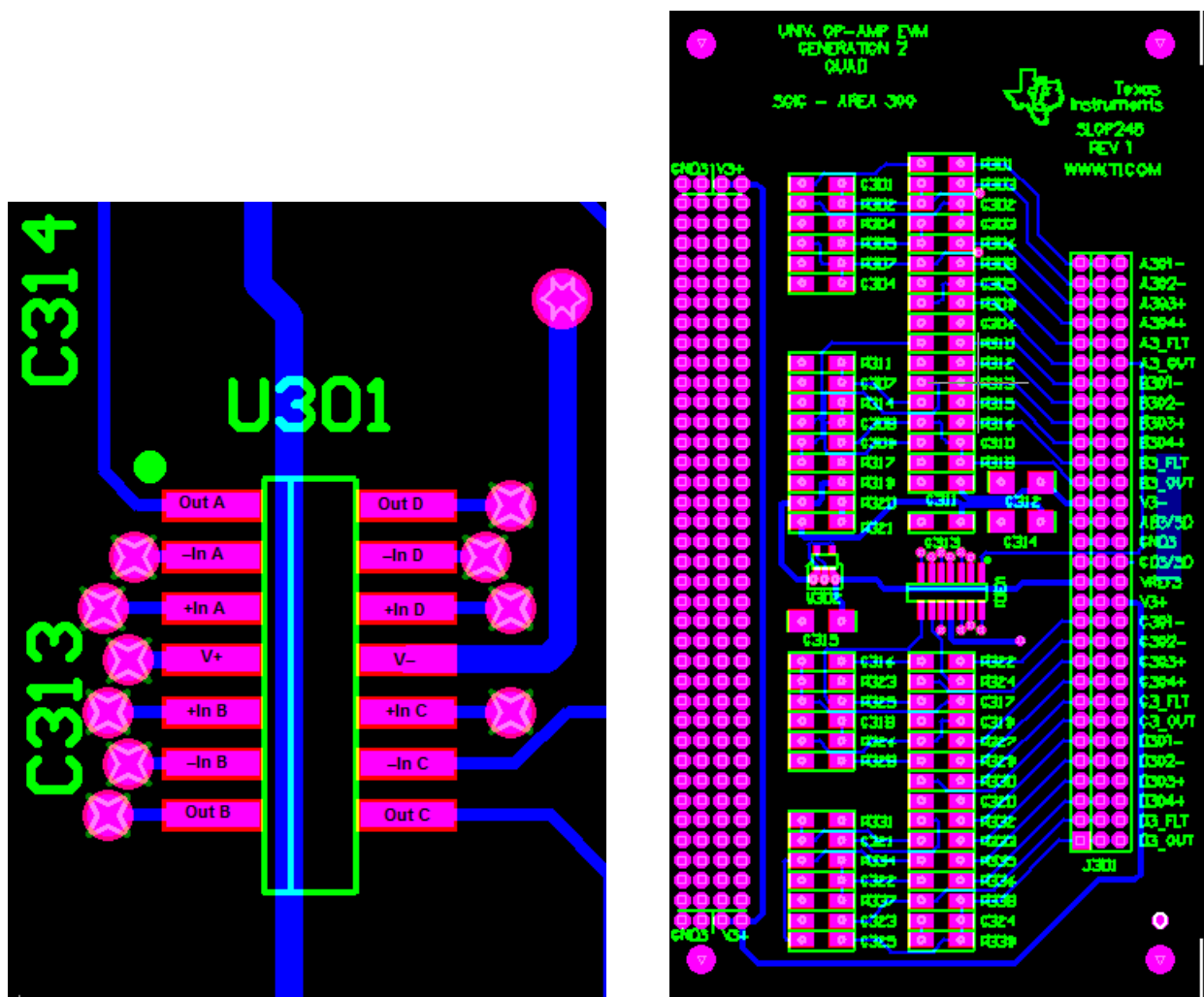

Figure 52. Board Layout Example

11 Device and Documentation Support

11.1 Trademarks

LinCMOS is a trademark of Texas Instruments.
All other trademarks are the property of their respective owners.

11.2 Electrostatic Discharge Caution



These devices have limited built-in ESD protection. The leads should be shorted together or the device placed in conductive foam during storage or handling to prevent electrostatic damage to the MOS gates.

11.3 Glossary

[SLYZ022](#) — *TI Glossary*.

This glossary lists and explains terms, acronyms, and definitions.

12 Mechanical, Packaging, and Orderable Information

The following pages include mechanical, packaging, and orderable information. This information is the most current data available for the designated devices. This data is subject to change without notice and revision of this document. For browser-based versions of this data sheet, refer to the left-hand navigation.

PACKAGING INFORMATION

Orderable part number	Status (1)	Material type (2)	Package Pins	Package qty Carrier	RoHS (3)	Lead finish/ Ball material (4)	MSL rating/ Peak reflow (5)	Op temp (°C)	Part marking (6)
TLC2274EPWRQ1	Active	Production	TSSOP (PW) 14	2000 LARGE T&R	Yes	NIPDAU	Level-2-260C-1 YEAR	-40 to 150	2274EQ1
TLC2274EPWRQ1.A	Active	Production	TSSOP (PW) 14	2000 LARGE T&R	Yes	NIPDAU	Level-2-260C-1 YEAR	-40 to 150	2274EQ1
TLC2274EPWRQ1.B	Active	Production	TSSOP (PW) 14	2000 LARGE T&R	Yes	NIPDAU	Level-2-260C-1 YEAR	-40 to 150	2274EQ1

(1) **Status:** For more details on status, see our [product life cycle](#).

(2) **Material type:** When designated, preproduction parts are prototypes/experimental devices, and are not yet approved or released for full production. Testing and final process, including without limitation quality assurance, reliability performance testing, and/or process qualification, may not yet be complete, and this item is subject to further changes or possible discontinuation. If available for ordering, purchases will be subject to an additional waiver at checkout, and are intended for early internal evaluation purposes only. These items are sold without warranties of any kind.

(3) **RoHS values:** Yes, No, RoHS Exempt. See the [TI RoHS Statement](#) for additional information and value definition.

(4) **Lead finish/Ball material:** Parts may have multiple material finish options. Finish options are separated by a vertical ruled line. Lead finish/Ball material values may wrap to two lines if the finish value exceeds the maximum column width.

(5) **MSL rating/Peak reflow:** The moisture sensitivity level ratings and peak solder (reflow) temperatures. In the event that a part has multiple moisture sensitivity ratings, only the lowest level per JEDEC standards is shown. Refer to the shipping label for the actual reflow temperature that will be used to mount the part to the printed circuit board.

(6) **Part marking:** There may be an additional marking, which relates to the logo, the lot trace code information, or the environmental category of the part.

Multiple part markings will be inside parentheses. Only one part marking contained in parentheses and separated by a "-" will appear on a part. If a line is indented then it is a continuation of the previous line and the two combined represent the entire part marking for that device.

Important Information and Disclaimer: The information provided on this page represents TI's knowledge and belief as of the date that it is provided. TI bases its knowledge and belief on information provided by third parties, and makes no representation or warranty as to the accuracy of such information. Efforts are underway to better integrate information from third parties. TI has taken and continues to take reasonable steps to provide representative and accurate information but may not have conducted destructive testing or chemical analysis on incoming materials and chemicals. TI and TI suppliers consider certain information to be proprietary, and thus CAS numbers and other limited information may not be available for release.

In no event shall TI's liability arising out of such information exceed the total purchase price of the TI part(s) at issue in this document sold by TI to Customer on an annual basis.

OTHER QUALIFIED VERSIONS OF TLC2274-HT :

- Catalog : [TLC2274](#)

- Automotive : [TLC2274-Q1](#)
- Enhanced Product : [TLC2274-EP](#)

NOTE: Qualified Version Definitions:

- Catalog - TI's standard catalog product
- Automotive - Q100 devices qualified for high-reliability automotive applications targeting zero defects
- Enhanced Product - Supports Defense, Aerospace and Medical Applications

TAPE AND REEL INFORMATION

QUADRANT ASSIGNMENTS FOR PIN 1 ORIENTATION IN TAPE

*All dimensions are nominal

Device	Package Type	Package Drawing	Pins	SPQ	Reel Diameter (mm)	Reel Width W1 (mm)	A0 (mm)	B0 (mm)	K0 (mm)	P1 (mm)	W (mm)	Pin1 Quadrant
TLC2274EPWRQ1	TSSOP	PW	14	2000	330.0	12.4	6.9	5.6	1.6	8.0	12.0	Q1

TAPE AND REEL BOX DIMENSIONS

*All dimensions are nominal

Device	Package Type	Package Drawing	Pins	SPQ	Length (mm)	Width (mm)	Height (mm)
TLC2274EPWRQ1	TSSOP	PW	14	2000	353.0	353.0	32.0

PW0014A



PACKAGE OUTLINE
TSSOP - 1.2 mm max height

SMALL OUTLINE PACKAGE



4220202/B 12/2023

NOTES:

1. All linear dimensions are in millimeters. Any dimensions in parenthesis are for reference only. Dimensioning and tolerancing per ASME Y14.5M.
2. This drawing is subject to change without notice.
3. This dimension does not include mold flash, protrusions, or gate burrs. Mold flash, protrusions, or gate burrs shall not exceed 0.15 mm per side.
4. This dimension does not include interlead flash. Interlead flash shall not exceed 0.25 mm per side.
5. Reference JEDEC registration MO-153.

EXAMPLE BOARD LAYOUT

PW0014A

TSSOP - 1.2 mm max height

SMALL OUTLINE PACKAGE



LAND PATTERN EXAMPLE
EXPOSED METAL SHOWN
SCALE: 10X



4220202/B 12/2023

NOTES: (continued)

- 6. Publication IPC-7351 may have alternate designs.
- 7. Solder mask tolerances between and around signal pads can vary based on board fabrication site.

EXAMPLE STENCIL DESIGN

PW0014A

TSSOP - 1.2 mm max height

SMALL OUTLINE PACKAGE



SOLDER PASTE EXAMPLE
BASED ON 0.125 mm THICK STENCIL
SCALE: 10X

4220202/B 12/2023

NOTES: (continued)

8. Laser cutting apertures with trapezoidal walls and rounded corners may offer better paste release. IPC-7525 may have alternate design recommendations.
9. Board assembly site may have different recommendations for stencil design.

IMPORTANT NOTICE AND DISCLAIMER

TI PROVIDES TECHNICAL AND RELIABILITY DATA (INCLUDING DATASHEETS), DESIGN RESOURCES (INCLUDING REFERENCE DESIGNS), APPLICATION OR OTHER DESIGN ADVICE, WEB TOOLS, SAFETY INFORMATION, AND OTHER RESOURCES "AS IS" AND WITH ALL FAULTS, AND DISCLAIMS ALL WARRANTIES, EXPRESS AND IMPLIED, INCLUDING WITHOUT LIMITATION ANY IMPLIED WARRANTIES OF MERCHANTABILITY, FITNESS FOR A PARTICULAR PURPOSE OR NON-INFRINGEMENT OF THIRD PARTY INTELLECTUAL PROPERTY RIGHTS.

These resources are intended for skilled developers designing with TI products. You are solely responsible for (1) selecting the appropriate TI products for your application, (2) designing, validating and testing your application, and (3) ensuring your application meets applicable standards, and any other safety, security, regulatory or other requirements.

These resources are subject to change without notice. TI grants you permission to use these resources only for development of an application that uses the TI products described in the resource. Other reproduction and display of these resources is prohibited. No license is granted to any other TI intellectual property right or to any third party intellectual property right. TI disclaims responsibility for, and you fully indemnify TI and its representatives against any claims, damages, costs, losses, and liabilities arising out of your use of these resources.

TI's products are provided subject to [TI's Terms of Sale](#), [TI's General Quality Guidelines](#), or other applicable terms available either on ti.com or provided in conjunction with such TI products. TI's provision of these resources does not expand or otherwise alter TI's applicable warranties or warranty disclaimers for TI products. Unless TI explicitly designates a product as custom or customer-specified, TI products are standard, catalog, general purpose devices.

TI objects to and rejects any additional or different terms you may propose.

Copyright © 2025, Texas Instruments Incorporated

Last updated 10/2025