

## TLVx171-Q1 36-V, Single-Supply, General-Purpose Operational Amplifier for Cost-Sensitive Automotive Systems

### 1 Features

- Qualified for Automotive Applications
- AEC-Q100 Test Guidance With the Following Results:
  - Device Temperature Grade 1: –40°C to +125°C Ambient Operating Temperature
  - Device HBM ESD Classification Level:
    - Level 3A for TLV171-Q1 and TLV2171-Q1
    - Level 2 for TLV4171-Q1
  - Device CDM ESD Classification Level
    - Level C4A for TLV171-Q1
    - Level C6 for TLV2171-Q1 and TLV4171-Q1
- Supply Range:
  - Single-Supply: 4.5 V to 36 V
  - Dual-Supply  $\pm 2.25$  V to  $\pm 18$  V
- Low Noise: 16 nV/ $\sqrt{\text{Hz}}$  at 1 kHz
- Low Offset Drift:  $\pm 1$   $\mu\text{V}/^\circ\text{C}$  (Typical)
- Input Range Includes Negative Supply
- Input Range Operates to Positive Supply With Reduced Performance
- Rail-to-Rail Output
- Gain Bandwidth: 3 MHz
- Low Quiescent Current: 525  $\mu\text{A}$  per Amplifier
- Common-Mode Rejection: 120 dB (Typical)
- Low Input Bias Current: 10 pA

### Offset Voltage vs Common-Mode Voltage: $V_{\text{SUPPLY}} = \pm 18$ V

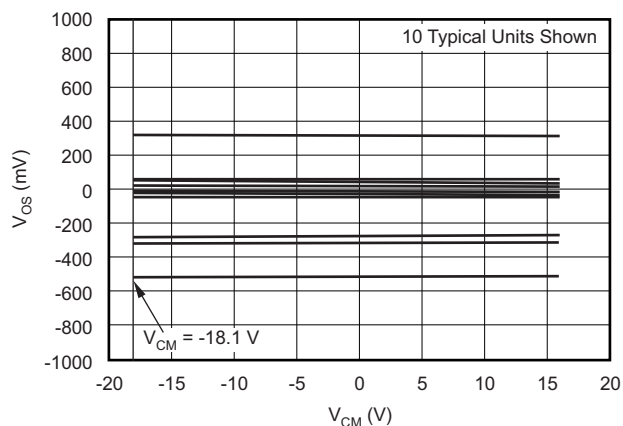

### 2 Applications

- Automotive
  - ADAS
  - Body Electronics
  - Lighting
  - Current Sensing
  - Power Train

### 3 Description

The TLVx171-Q1 family of devices is a 36-V, single-supply, low-noise operational amplifier (op amp) with the ability to operate on supplies ranging from 4.5 V ( $\pm 2.25$  V) to 36 V ( $\pm 18$  V). This series is available in multiple packages and offers low offset, drift, and low quiescent current. The single, dual, and quad versions all have identical specifications for maximum design flexibility.

#### Device Information<sup>(1)</sup>

PART NUMBER	PACKAGE	BODY SIZE (NOM)
TLV171-Q1	SOT-23 (5)	2.90 mm x 1.60 mm
TLV2171-Q1	SOIC (8)	4.90 mm x 3.91 mm
	VSSOP (8)	3.00 mm x 3.00 mm
TLV4171-Q1	SOIC (14)	8.65 mm x 3.91 mm
	TSSOP (14)	5.00 mm x 4.40 mm

(1) For all available packages, see the orderable addendum at the end of the data sheet.

### Offset Voltage vs Power Supply

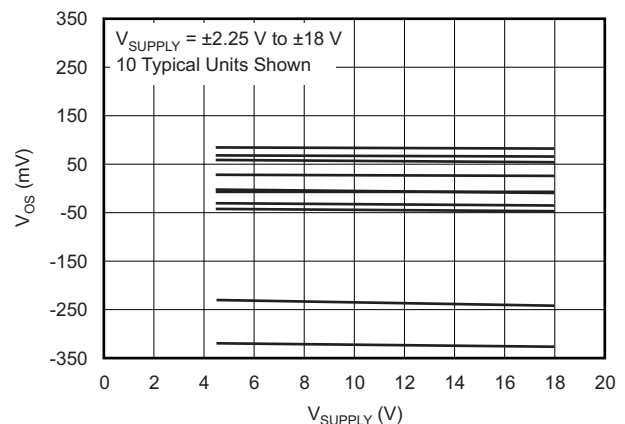

## Table of Contents

<b>1 Features</b> .....	<b>1</b>	7.3 Feature Description.....	<b>17</b>
<b>2 Applications</b> .....	<b>1</b>	7.4 Device Functional Modes.....	<b>19</b>
<b>3 Description</b> .....	<b>1</b>	<b>8 Application and Implementation</b> .....	<b>20</b>
<b>4 Description (continued)</b> .....	<b>3</b>	8.1 Application Information.....	<b>20</b>
<b>5 Pin Configuration and Functions</b> .....	<b>4</b>	8.2 Typical Application .....	<b>21</b>
<b>6 Specifications</b> .....	<b>7</b>	<b>9 Power Supply Recommendations</b> .....	<b>23</b>
6.1 Absolute Maximum Ratings .....	<b>7</b>	<b>10 Layout</b> .....	<b>23</b>
6.2 ESD Ratings.....	<b>7</b>	10.1 Layout Guidelines .....	<b>23</b>
6.3 Recommended Operating Conditions.....	<b>7</b>	10.2 Layout Example .....	<b>24</b>
6.4 Thermal Information: TLV171-Q1 .....	<b>8</b>	<b>11 Device and Documentation Support</b> .....	<b>24</b>
6.5 Thermal Information: TLV2171-Q1 .....	<b>8</b>	11.1 Documentation Support .....	<b>24</b>
6.6 Thermal Information: TLV4171-Q1 .....	<b>8</b>	11.2 Related Links .....	<b>24</b>
6.7 Electrical Characteristics.....	<b>9</b>	11.3 Community Resource.....	<b>25</b>
6.8 Typical Characteristics.....	<b>11</b>	11.4 Trademarks .....	<b>25</b>
<b>7 Detailed Description</b> .....	<b>17</b>	11.5 Electrostatic Discharge Caution.....	<b>25</b>
7.1 Overview .....	<b>17</b>	11.6 Glossary .....	<b>25</b>
7.2 Functional Block Diagram .....	<b>17</b>	<b>12 Mechanical, Packaging, and Orderable Information</b> .....	<b>25</b>

### Table 1. Revision History

DATE	REVISION	NOTES
April 2017	SBOS858	Initial release.

#### 4 Description (continued)

Unlike most op amps, which are specified at only one supply voltage, the TLVx171-Q1 family of devices is specified from 4.5 V to 36 V. Input signals beyond the supply rails do not cause phase reversal. The TLVx171-Q1 family of devices is stable with capacitive loads up to 300 pF. The input can operate 100 mV below the negative rail and within 2 V of the top rail during normal operation. The device can operate with full rail-to-rail input 100 mV beyond the top rail, but with reduced performance within 2 V of the top rail.

The TLVx171-Q1 op amp family is specified from  $-40^{\circ}\text{C}$  to  $+125^{\circ}\text{C}$ .

## 5 Pin Configuration and Functions

**TLV171-Q1 DBV Package  
5-Pin SOT-23  
Top View**

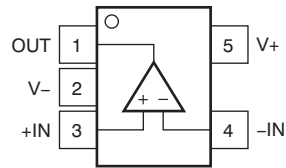

**Pin Functions**

PIN		I/O	DESCRIPTION
NAME	NO.		
+IN	3	I	Noninverting input
-IN	4	I	Inverting input
OUT	1	O	Output
V+	5	—	Positive (highest) power supply
V-	2	—	Negative (lowest) power supply

**TLV2171-Q1 D or DGK Packages  
8-Pin SOIC or VSSOP  
Top View**

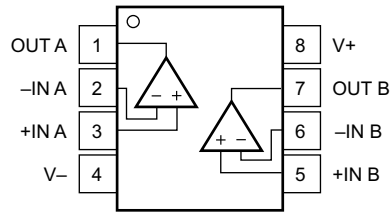

**Pin Functions**

PIN		I/O	DESCRIPTION
NAME	NO.		
+IN A	3	I	Noninverting input, channel A
+IN B	5	I	Noninverting input, channel B
-IN A	2	I	Inverting input, channel A
-IN B	6	I	Inverting input, channel B
OUT A	1	O	Output, channel A
OUT B	7	O	Output, channel B
V+	8	—	Positive (highest) power supply
V-	4	—	Negative (lowest) power supply

**TLV4171-Q1 D and PW Packages  
14-Pin SOIC and TSSOP  
Top View**

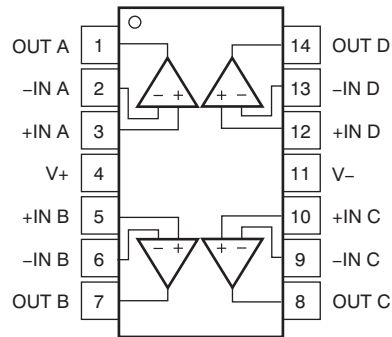

**Pin Functions**

PIN		I/O	DESCRIPTION
NAME	NO.		
+IN A	3	I	Noninverting input, channel A
+IN B	5	I	Noninverting input, channel B
+IN C	10	I	Noninverting input, channel C
+IN D	12	I	Noninverting input, channel D
-IN A	2	I	Inverting input, channel A
-IN B	6	I	Inverting input, channel B
-IN C	9	I	Inverting input, channel C
-IN D	13	I	Inverting input, channel D
OUT A	1	O	Output, channel A
OUT B	7	O	Output, channel B
OUT C	8	O	Output, channel C
OUT D	14	O	Output, channel D
V+	4	—	Positive (highest) power supply
V-	11	—	Negative (lowest) power supply

## 6 Specifications

### 6.1 Absolute Maximum Ratings

over operating free-air temperature range (unless otherwise noted)<sup>(1)</sup>

		MIN	MAX	UNIT
Supply voltage, $V_S$		40		V
Signal input terminals	Voltage	(V-) – 0.5	(V+) + 0.5	V
	Current	±10		mA
Output short circuit <sup>(2)</sup>		Continuous		
Junction temperature, $T_J$		150		°C
Latch-up per JESD78D		Class 1		
Storage temperature, $T_{stg}$		–65	150	°C

(1) Stresses above these ratings may cause permanent damage. Exposure to absolute maximum conditions for extended periods may degrade device reliability. These are stress ratings only, and functional operation of the device at these or any other conditions beyond those specified is not implied.

(2) Short-circuit to ground, one amplifier per package.

### 6.2 ESD Ratings

			VALUE	UNIT
<b>TLV171-Q1 IN DBV PACKAGE</b>				
$V_{(ESD)}$	Electrostatic discharge	Human body model (HBM), per AEC Q100-002 <sup>(1)</sup>	±4000	V
		Charged device model (CDM), per AEC Q100-011	±500	
<b>TLV2171-Q1 IN D AND DGK PACKAGES</b>				
$V_{(ESD)}$	Electrostatic discharge	Human body model (HBM), per AEC Q100-002 <sup>(1)</sup>	±4000	V
		Charged device model (CDM), per AEC Q100-011	±1000	
<b>TLV4171-Q1 IN D AND PW PACKAGES</b>				
$V_{(ESD)}$	Electrostatic discharge	Human body model (HBM), per AEC Q100-002 <sup>(1)</sup>	±2000	V
		Charged device model (CDM), per AEC Q100-011	±1000	

(1) AEC Q100-002 indicates HBM stressing is done in accordance with the ANSI/ESDA/JEDEC JS-001 specification.

### 6.3 Recommended Operating Conditions

over operating free-air temperature range (unless otherwise noted)

	MIN	NOM	MAX	UNIT
Supply voltage ( $V_+$ – $V_-$ )	4.5 (±2.25)		36 (±18)	V
Specified operating temperature	–40		125	°C

#### 6.4 Thermal Information: TLV171-Q1

THERMAL METRIC <sup>(1)</sup>		TLV171-Q1		UNIT
		DBV (SOT-23)		
		5 PINS		
$R_{\theta JA}$	Junction-to-ambient thermal resistance	277.3		°C/W
$R_{\theta JC(top)}$	Junction-to-case (top) thermal resistance	193.3		°C/W
$R_{\theta JB}$	Junction-to-board thermal resistance	121.2		°C/W
$\Psi_{JT}$	Junction-to-top characterization parameter	51.8		°C/W
$\Psi_{JB}$	Junction-to-board characterization parameter	109.5		°C/W

(1) For more information about traditional and new thermal metrics, see the [Semiconductor and IC Package Thermal Metrics](#) application report.

#### 6.5 Thermal Information: TLV2171-Q1

THERMAL METRIC <sup>(1)</sup>		TLV2171-Q1		UNIT
		D (SOIC)	DGK (VSSOP)	
		8 PINS	8 PINS	
$R_{\theta JA}$	Junction-to-ambient thermal resistance	116.1	186.5	°C/W
$R_{\theta JC(top)}$	Junction-to-case (top) thermal resistance	69.8	78	°C/W
$R_{\theta JB}$	Junction-to-board thermal resistance	56.6	107.8	°C/W
$\Psi_{JT}$	Junction-to-top characterization parameter	22.5	15.6	°C/W
$\Psi_{JB}$	Junction-to-board characterization parameter	56.1	106.2	°C/W

(1) For more information about traditional and new thermal metrics, see the [Semiconductor and IC Package Thermal Metrics](#) application report.

#### 6.6 Thermal Information: TLV4171-Q1

THERMAL METRIC <sup>(1)</sup>		TLV4171-Q1		UNIT
		D (SOIC)	PW (TSSOP)	
		14 PINS	14 PINS	
$R_{\theta JA}$	Junction-to-ambient thermal resistance	93.2	106.9	°C/W
$R_{\theta JC(top)}$	Junction-to-case (top) thermal resistance	51.8	24.4	°C/W
$R_{\theta JB}$	Junction-to-board thermal resistance	49.4	59.3	°C/W
$\Psi_{JT}$	Junction-to-top characterization parameter	13.5	0.6	°C/W
$\Psi_{JB}$	Junction-to-board characterization parameter	42.2	54.3	°C/W

(1) For more information about traditional and new thermal metrics, see the [Semiconductor and IC Package Thermal Metrics](#) application report.

## 6.7 Electrical Characteristics

at  $T_A = 25^\circ\text{C}$ ,  $V_S = 4.5\text{ V to }36\text{ V}$ ,  $V_{CM} = V_{OUT} = V_S / 2$ , and  $R_{LOAD} = 10\text{ k}\Omega$  connected to  $V_S / 2$  (unless otherwise noted)

PARAMETER		TEST CONDITIONS	MIN	TYP	MAX	UNIT
<b>OFFSET VOLTAGE</b>						
$V_{OS}$	Input offset voltage			0.75	$\pm 2.7$	mV
	Input offset voltage over temperature	$T_A = -40^\circ\text{C to }125^\circ\text{C}$			$\pm 3$	mV
$dV_{OS}/dT$	Input offset voltage drift (over temperature)	$T_A = -40^\circ\text{C to }125^\circ\text{C}$		1		$\mu\text{V}/^\circ\text{C}$
PSRR	Input offset voltage over temperature vs power supply	$V_S = 4.5\text{ V to }36\text{ V}$	90	120		dB

**Electrical Characteristics (continued)**

 at  $T_A = 25^\circ\text{C}$ ,  $V_S = 4.5\text{ V to }36\text{ V}$ ,  $V_{CM} = V_{OUT} = V_S / 2$ , and  $R_{LOAD} = 10\text{ k}\Omega$  connected to  $V_S / 2$  (unless otherwise noted)

PARAMETER		TEST CONDITIONS	MIN	TYP	MAX	UNIT
<b>INPUT BIAS CURRENT</b>						
$I_B$	Input bias current			$\pm 10$		$\mu\text{A}$
$I_{OS}$	Input offset current			$\pm 4$		$\mu\text{A}$
<b>NOISE</b>						
	Input voltage noise	$f = 0.1\text{ Hz to }10\text{ Hz}$		3		$\mu\text{V}_{PP}$
$e_n$	Input voltage noise density	$f = 100\text{ Hz}$		27		$\text{nV}/\sqrt{\text{Hz}}$
		$f = 1\text{ kHz}$		16		$\text{nV}/\sqrt{\text{Hz}}$
<b>INPUT VOLTAGE</b>						
$V_{CM}$	Common-mode voltage range <sup>(1)</sup>		$(V-) - 0.1$		$(V+) - 2$	V
CMRR	Common-mode rejection ratio (over temperature)	$V_S = \pm 2.25\text{ V}$ $(V-) - 0.1\text{ V} < V_{CM} < (V+) - 2\text{ V}$	90	120		dB
		$V_S = \pm 18\text{ V}$ $(V-) - 0.1\text{ V} < V_{CM} < (V+) - 2\text{ V}$	94	120		dB
<b>INPUT IMPEDANCE</b>						
	Differential			$100 \parallel 3$		$\text{M}\Omega \parallel \text{pF}$
	Common-mode			$6 \parallel 3$		$10^{12}\Omega \parallel \text{pF}$
<b>OPEN-LOOP GAIN</b>						
$A_{OL}$	Open-loop voltage gain (over temperature)	$V_S = 4.5\text{ V to }36\text{ V}$ $(V-) + 0.35\text{ V} < V_O < (V+) - 0.35\text{ V}$	94	130		dB
<b>FREQUENCY RESPONSE</b>						
GBP	Gain bandwidth product			3		MHz
SR	Slew rate	$G = 1$		1.5		$\text{V}/\mu\text{s}$
$t_s$	Settling time	To 0.1%, $V_S = \pm 18\text{ V}$ $G = 1, 10\text{-V step}$		6		$\mu\text{s}$
		To 0.01% (12 bit), $V_S = \pm 18\text{ V}$ $G = 1, 10\text{-V step}$		10		$\mu\text{s}$
	Overload recovery time	$V_{\pm IN} \times \text{Gain} > V_S$		2		$\mu\text{s}$
THD+N	Total harmonic distortion + noise	$G = 1, f = 1\text{ kHz}$ $V_O = 3 V_{RMS}$		0.0002%		
<b>OUTPUT</b>						
$V_O$	Voltage output swing from rail (over temperature)	$R_L = 10\text{ k}\Omega$ $A_{OL} \geq 110\text{ dB}$	$(V-) + 0.35$		$(V+) - 0.35$	V
$I_{SC}$	Short-circuit current	Sourcing		25		mA
		Sinking		-37		
$C_{LOAD}$	Capacitive load drive			See <a href="#">Typical Characteristics</a>		pF
$R_O$	Open-loop output resistance	$f = 1\text{ MHz}, I_O = 0\text{ A}$		150		$\Omega$
<b>POWER SUPPLY</b>						
$V_S$	Specified voltage range	$T_A = -40^\circ\text{C to }125^\circ\text{C}$	4.5		36	V
$I_Q$	Quiescent current per amplifier	$I_O = 0\text{ A}, T_A = -40^\circ\text{C to }125^\circ\text{C}$		525	695	$\mu\text{A}$

(1) The input range can be extended beyond  $(V+) - 2\text{ V}$  up to  $V_+$  at reduced performance. See [Typical Characteristics](#) and [Detailed Description](#) for additional information.

## 6.8 Typical Characteristics

$V_S = \pm 18\text{ V}$ ,  $V_{CM} = V_S / 2$ ,  $R_{LOAD} = 10\text{ k}\Omega$  connected to  $V_S / 2$ , and  $C_L = 100\text{ pF}$  (unless otherwise noted)

**Table 2. Characteristic Performance Measurements**

DESCRIPTION	FIGURE
Offset Voltage Production Distribution	<a href="#">Figure 1</a>
Offset Voltage vs Common-Mode Voltage	<a href="#">Figure 2</a>
Offset Voltage vs Common-Mode Voltage (Upper Stage)	<a href="#">Figure 3</a>
Input Bias Current vs Temperature	<a href="#">Figure 5</a>
Output Voltage Swing vs Output Current (Maximum Supply)	<a href="#">Figure 6</a>
CMRR and PSRR vs Frequency (Referred-to Input)	<a href="#">Figure 7</a>
0.1Hz to 10Hz Noise	<a href="#">Figure 8</a>
Input Voltage Noise Spectral Density vs Frequency	<a href="#">Figure 9</a>
Quiescent Current vs Supply Voltage	<a href="#">Figure 10</a>
Open-Loop Gain and Phase vs Frequency	<a href="#">Figure 11</a>
Closed-Loop Gain vs Frequency	<a href="#">Figure 12</a>
Open-Loop Gain vs Temperature	<a href="#">Figure 13</a>
Open-Loop Output Impedance vs Frequency	<a href="#">Figure 14</a>
Small-Signal Overshoot vs Capacitive Load (100-mV Output Step)	<a href="#">Figure 15</a> ,
No Phase Reversal	<a href="#">Figure 17</a>
Small-Signal Step Response (100 mV)	<a href="#">Figure 18</a> , <a href="#">Figure 19</a>
Large-Signal Step Response	<a href="#">Figure 20</a> , <a href="#">Figure 21</a>
Large-Signal Settling Time (10-V Positive Step)	<a href="#">Figure 22</a>
Large-Signal Settling Time (10-V Negative Step)	<a href="#">Figure 23</a>
Short-Circuit Current vs Temperature	<a href="#">Figure 24</a>
Maximum Output Voltage vs Frequency	<a href="#">Figure 25</a>

6.8.1 Typical Characteristics

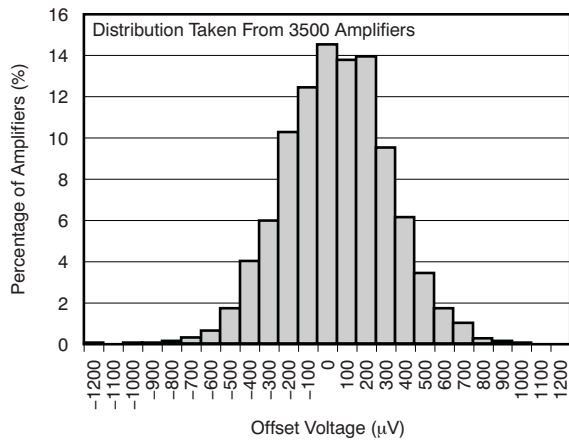

Figure 1. Offset Voltage Production Distribution

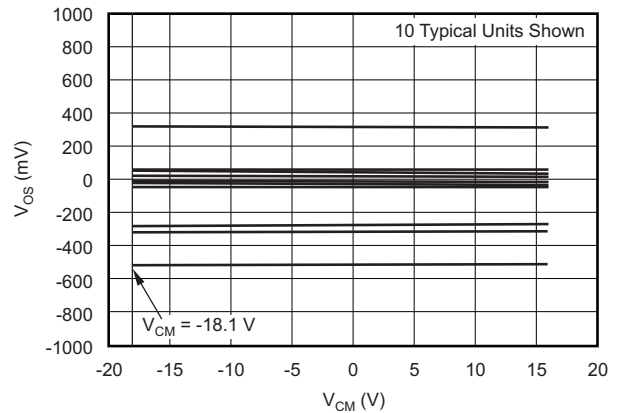

Figure 2. Offset Voltage vs Common-Mode Voltage:  
 $V_{SUPPLY} (V) = \pm 18 V$

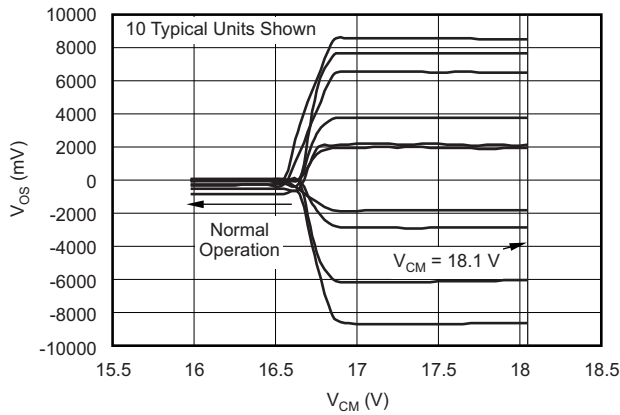

Figure 3. Offset Voltage vs Common-Mode Voltage:  
 $V_{SUPPLY} (V) = \pm 18 V$   
(Upper Stage)

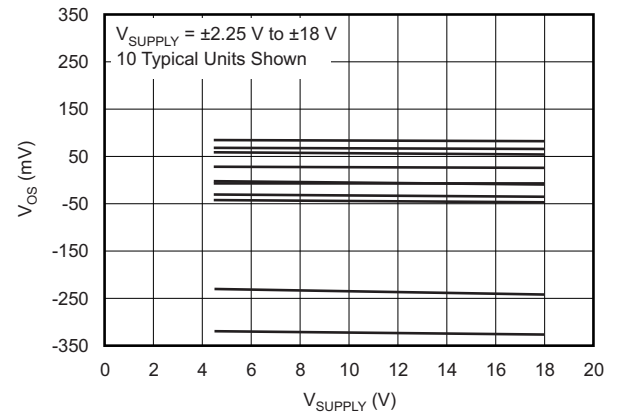

Figure 4. Offset Voltage vs Power Supply

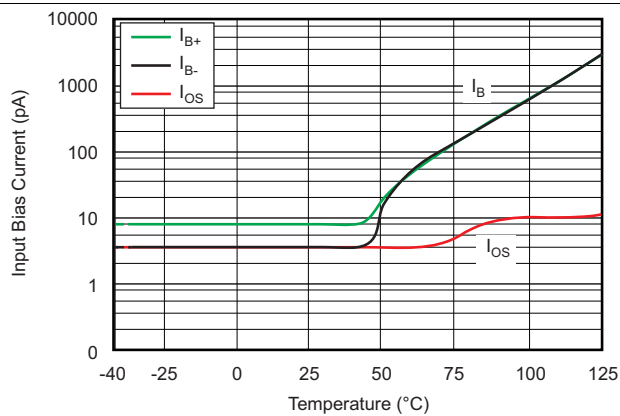

Figure 5. Input Bias Current vs Temperature

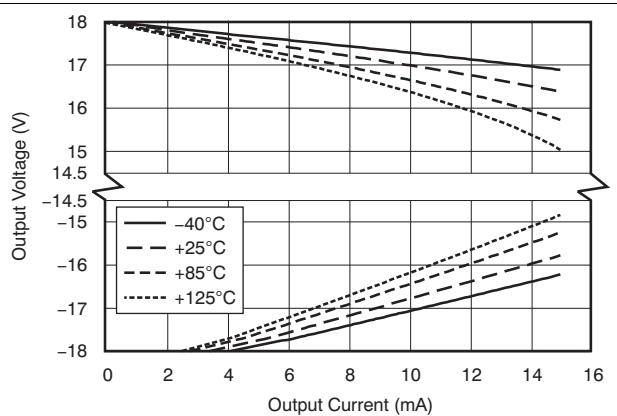
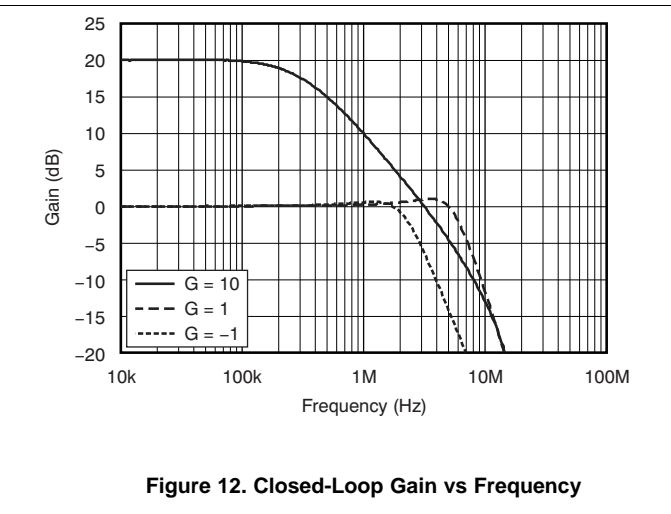
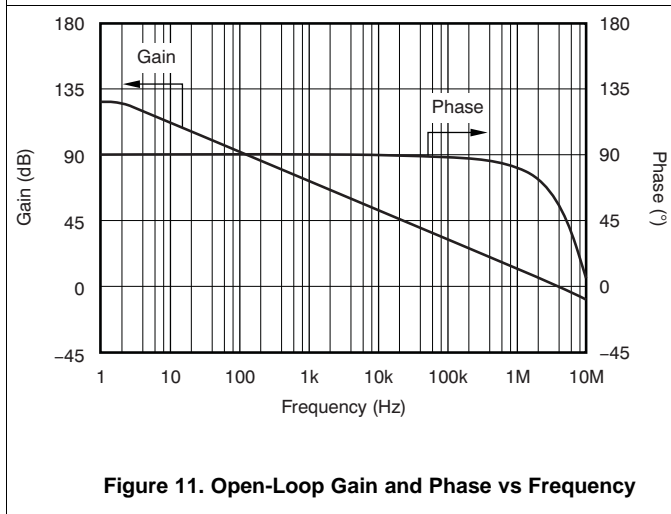
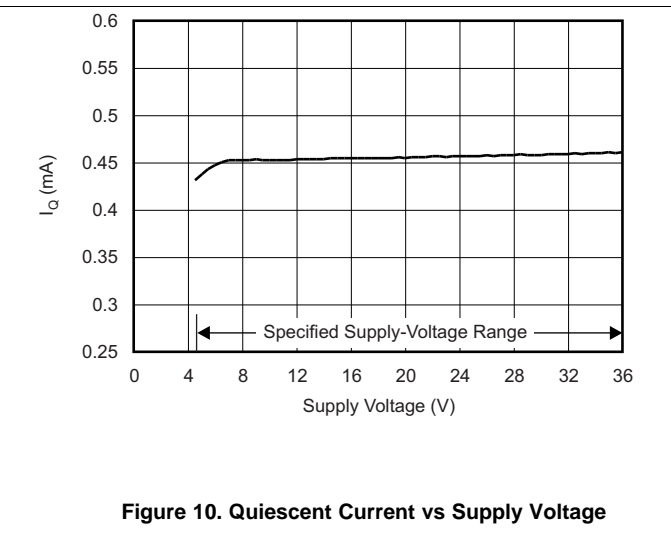
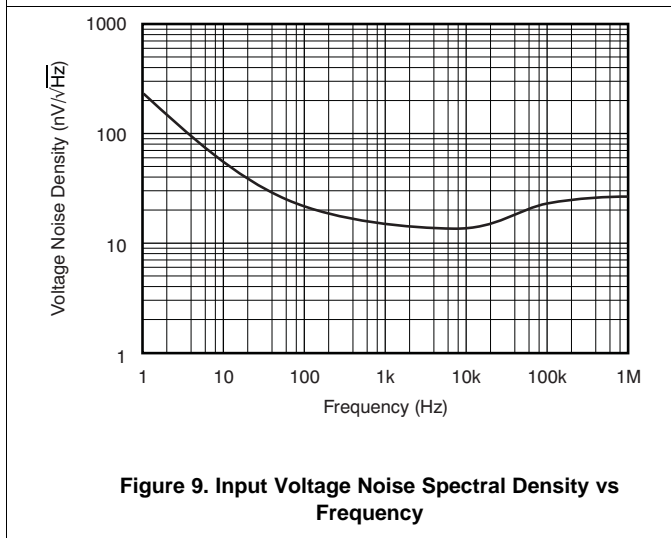
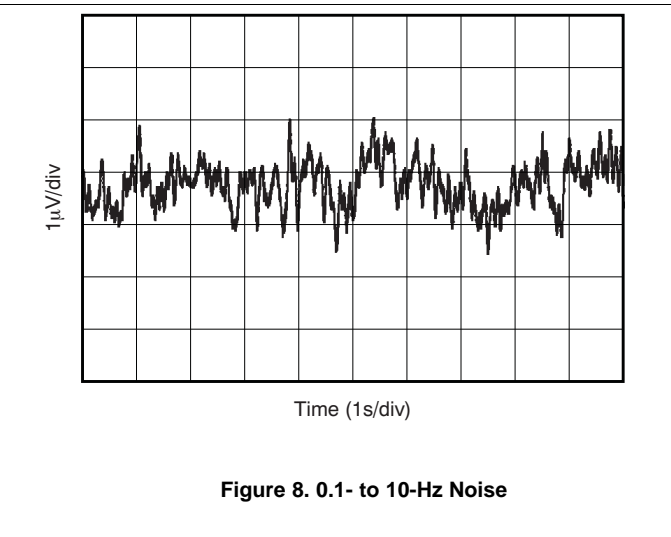
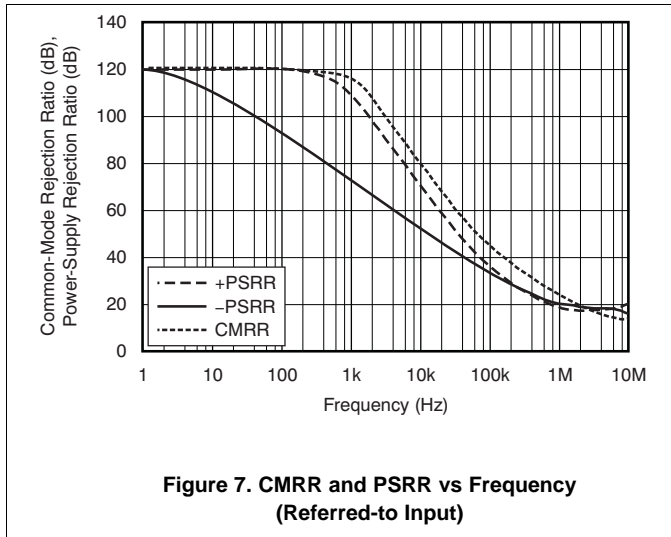

Figure 6. Output Voltage Swing vs Output Current  
(Maximum Supply)

Typical Characteristics (continued)



Typical Characteristics (continued)

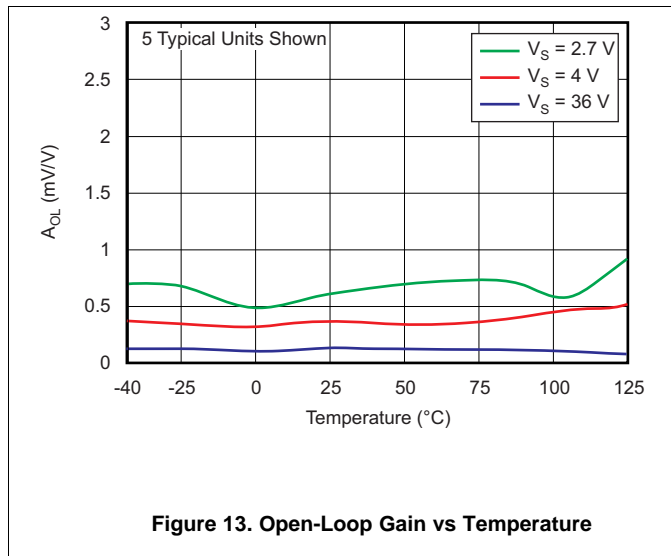

Figure 13. Open-Loop Gain vs Temperature

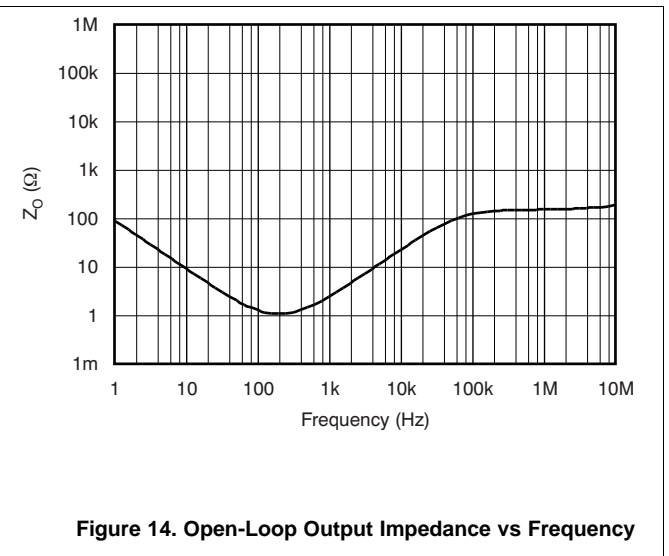

Figure 14. Open-Loop Output Impedance vs Frequency

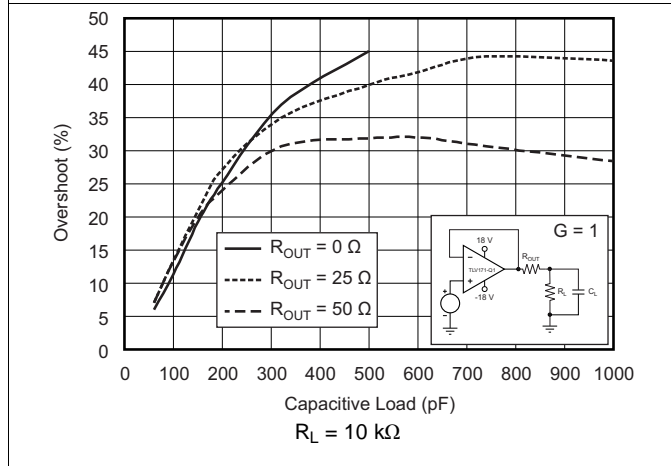

Figure 15. Noninverting Small-Signal Overshoot vs Capacitive Load (100-mV Output Step)

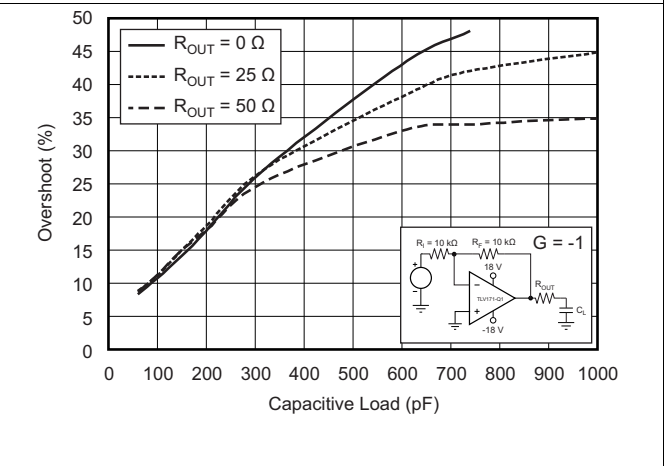

Figure 16. Inverting Small-Signal Overshoot vs Capacitive Load (100-mV Output Step)

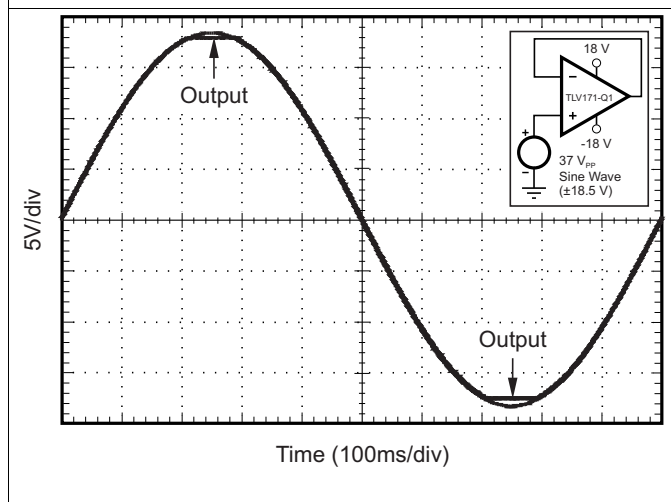

Figure 17. No Phase Reversal

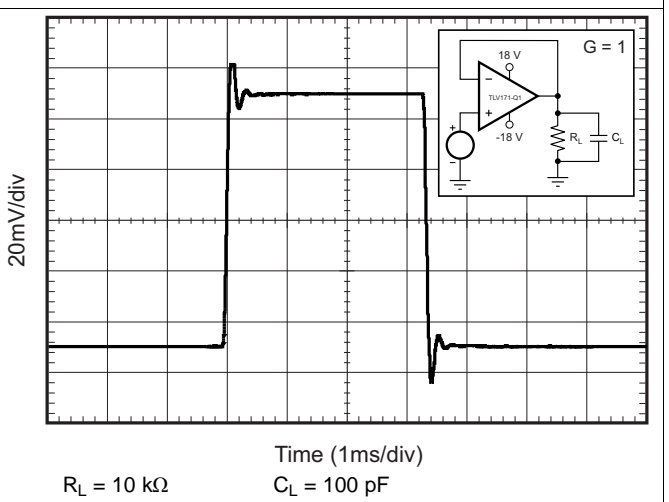

Figure 18. Small-Signal Step Response (100 mV)

Typical Characteristics (continued)

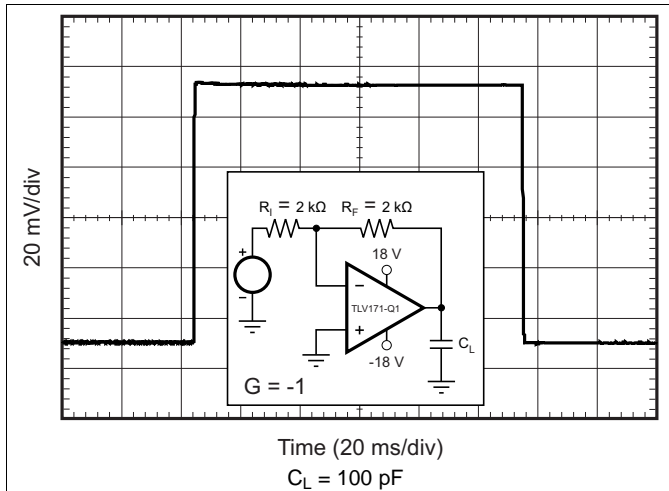

Figure 19. Small-Signal Step Response (100 mV)

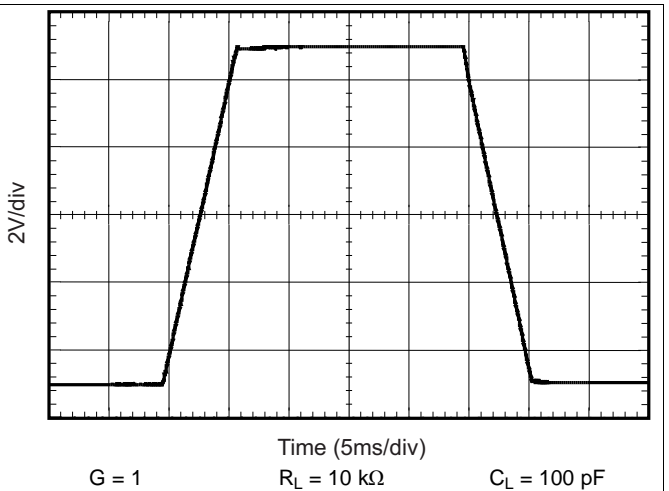

Figure 20. Large-Signal Step Response

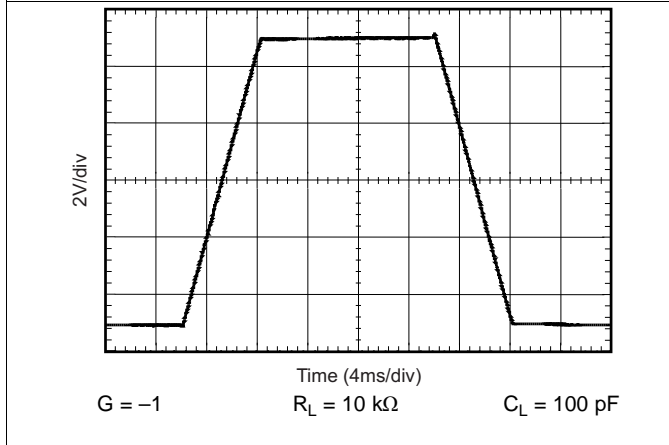

Figure 21. Large-Signal Step Response

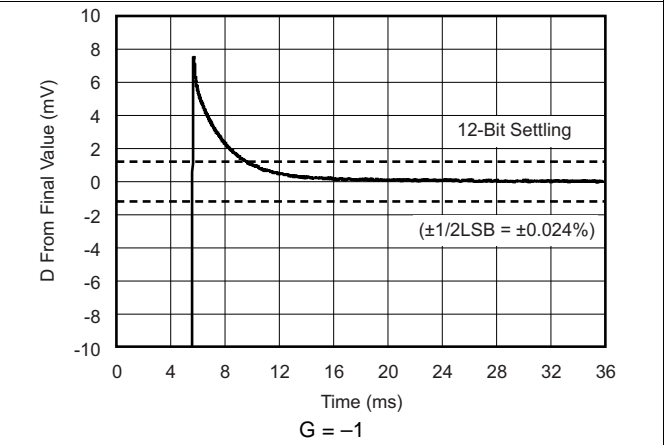

Figure 22. Large-Signal Settling Time (10-V Positive Step)

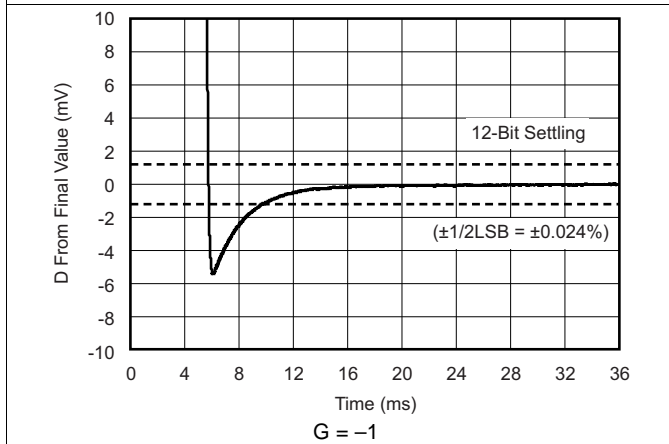

Figure 23. Large-Signal Settling Time (10-V Negative Step)

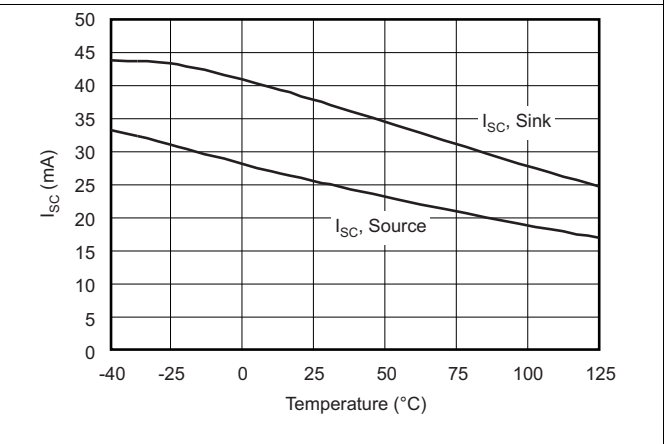
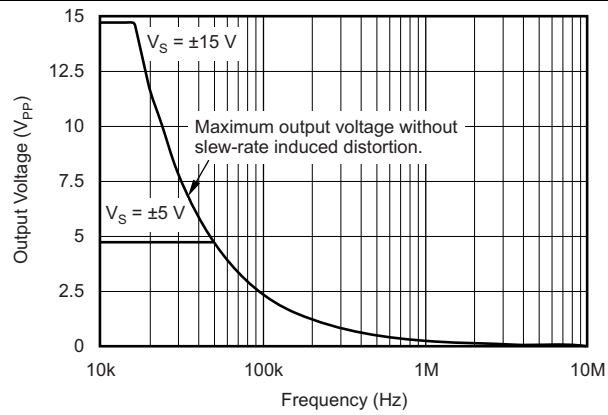

Figure 24. Short-Circuit Current vs Temperature

**Typical Characteristics (continued)**



**Figure 25. Maximum Output Voltage vs Frequency**

## 7 Detailed Description

### 7.1 Overview

The TLVx171-Q1 family of operational amplifiers provides high overall performance, making them ideal for many general-purpose applications. The excellent offset drift of only  $1 \mu\text{V}/^\circ\text{C}$  (typical) provides excellent stability over the entire temperature range. In addition, the device offers very good overall performance with high CMRR, PSRR, AOL, and superior THD.

### 7.2 Functional Block Diagram

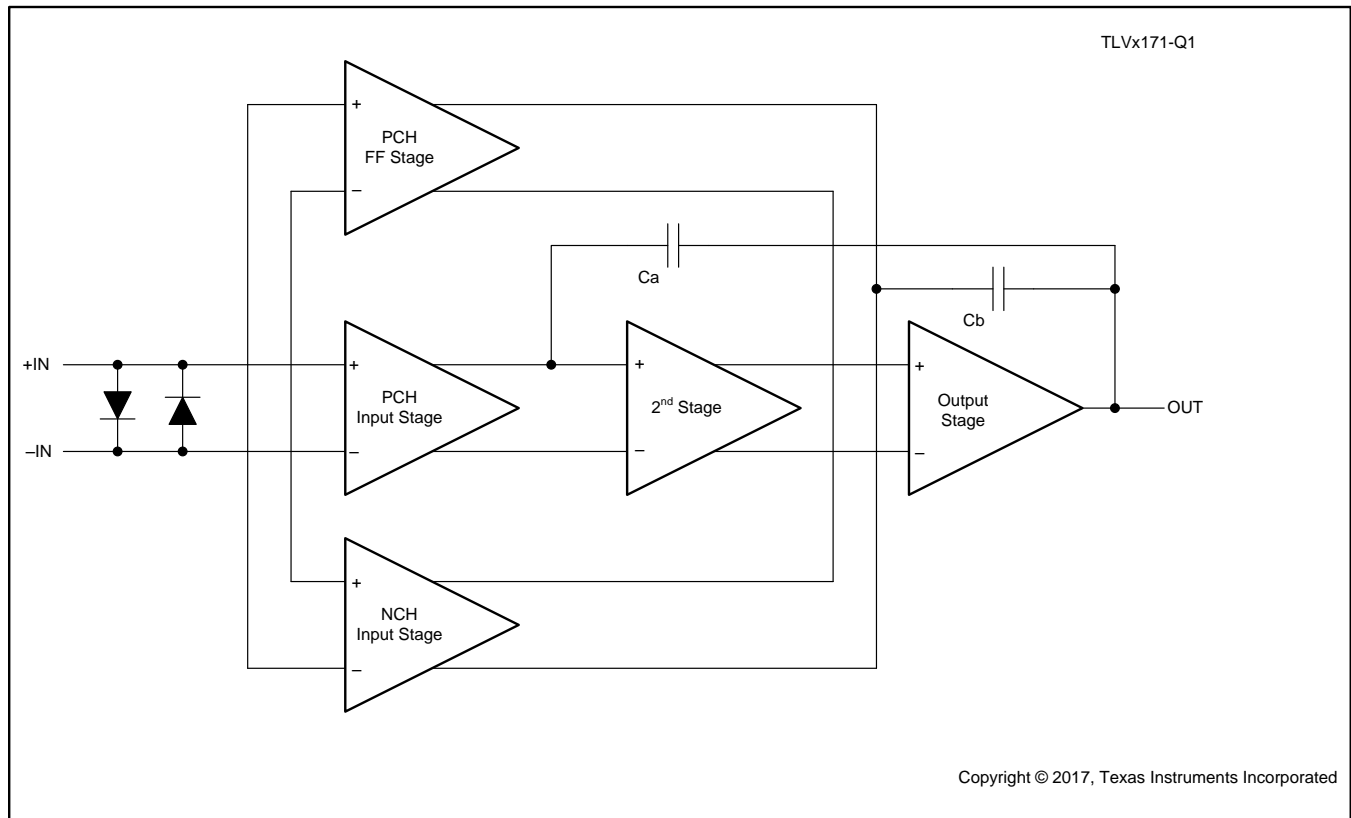

### 7.3 Feature Description

#### 7.3.1 Operating Characteristics

The TLVx171-Q1 family of devices is specified for operation from 4.5 V to 36 V ( $\pm 2.25 \text{ V}$  to  $\pm 18 \text{ V}$ ). Many of the specifications apply from  $-40^\circ\text{C}$  to  $+125^\circ\text{C}$ . Parameters that can exhibit significant variance with regard to operating voltage or temperature are shown in [Typical Characteristics](#).

#### 7.3.2 Phase-Reversal Protection

The TLVx171-Q1 family of devices has an internal phase-reversal protection. Many op amps exhibit a phase reversal when the input is driven beyond the linear common-mode range. This condition is most often encountered in noninverting circuits when the input is driven beyond the specified common-mode voltage range, causing the output to reverse into the opposite rail. The input of the TLVx171-Q1 family of devices prevents phase reversal with excessive common-mode voltage. Instead, the output limits into the appropriate rail. [Figure 26](#) shows this performance.

Feature Description (continued)

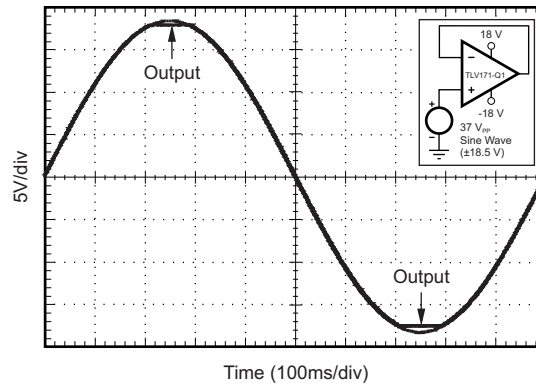

Figure 26. No Phase Reversal

7.3.3 Capacitive Load and Stability

The dynamic characteristics of the TLVx171-Q1 family of devices are optimized for commonly encountered operating conditions. The combination of low closed-loop gain and high capacitive loads decreases the phase margin of the amplifier and can lead to gain peaking or oscillations. As a result, heavier capacitive loads must be isolated from the output. The simplest way to achieve this isolation is to add a small resistor (for example,  $R_{OUT}$  equal to 50  $\Omega$ ) in series with the output. Figure 27 and Figure 28 shows small-signal overshoot versus capacitive load for several values of  $R_{OUT}$ . For details of analysis techniques and application circuits, see [Applications Bulletin AB-028](#), available for download from [TI.com](#).

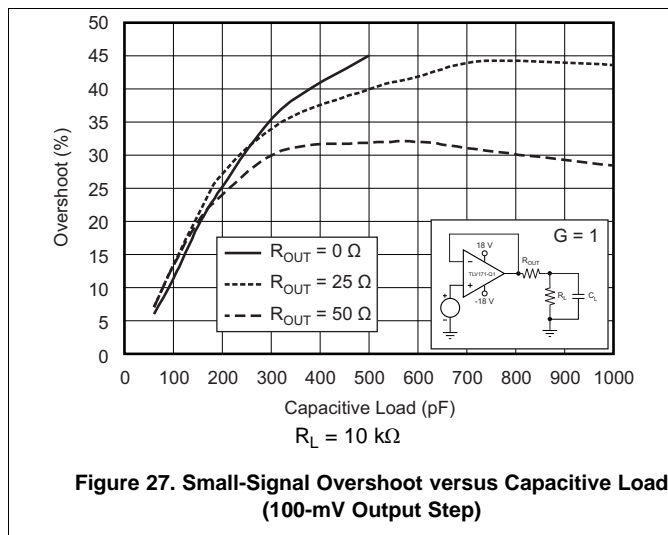

Figure 27. Small-Signal Overshoot versus Capacitive Load (100-mV Output Step)

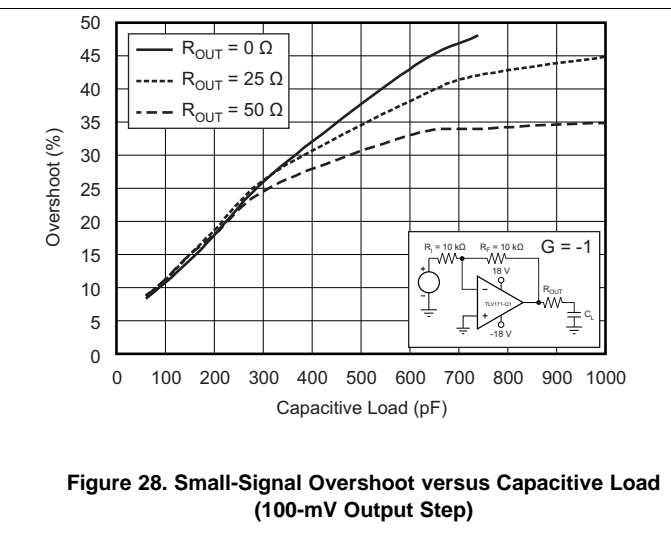

Figure 28. Small-Signal Overshoot versus Capacitive Load (100-mV Output Step)

## 7.4 Device Functional Modes

### 7.4.1 Common-Mode Voltage Range

The input common-mode voltage range of the TLVx171-Q1 family of devices extends 100 mV below the negative rail and within 2 V of the top rail for normal operation.

This device can operate with full rail-to-rail input 100 mV beyond the top rail, but with reduced performance within 2 V of the top rail. The typical performance in this range is listed in [Table 3](#).

**Table 3. Typical Performance Range**

PARAMETER	MIN	TYP	MAX	UNIT
Input common-mode voltage	$(V+) - 2$		$(V+) + 0.1$	V
Offset voltage		7		mV
Offset voltage vs temperature		12		$\mu\text{V}/^\circ\text{C}$
Common-mode rejection		65		dB
Open-loop gain		60		dB
GBW		0.7		MHz
Slew rate		0.7		$\text{V}/\mu\text{s}$
Noise at $f = 1\text{kHz}$		30		$\text{nV}/\sqrt{\text{Hz}}$

## 8 Application and Implementation

### NOTE

Information in the following applications sections is not part of the TI component specification, and TI does not warrant its accuracy or completeness. TI's customers are responsible for determining suitability of components for their purposes. Customers should validate and test their design implementation to confirm system functionality.

### 8.1 Application Information

The TLV171-Q1 operational amplifier family provides high overall performance, making the device ideal for many general-purpose applications. The excellent offset drift of only  $1 \mu\text{V}/^\circ\text{C}$  provides excellent stability over the entire temperature range. In addition, the device offers very good overall performance with high CMRR, PSRR, and  $A_{OL}$ . As with all amplifiers, applications with noisy or high-impedance power supplies require decoupling capacitors close to the device pins. In most cases,  $0.1\text{-}\mu\text{F}$  capacitors are adequate.

#### 8.1.1 Electrical Overstress

Designers often ask questions about the capability of an op amp to withstand electrical overstress. These questions tend to focus on the device inputs, but may involve the supply voltage pins or even the output pin. Each of these different pin functions have electrical stress limits determined by the voltage breakdown characteristics of the particular semiconductor fabrication process and specific circuits connected to the pin. Additionally, internal electrostatic discharge (ESD) protection is built into these circuits to protect them from accidental ESD events both before and during product assembly.

These ESD protection diodes also provide in-circuit, input overdrive protection, as long as the current is limited to 10 mA as stated in [Absolute Maximum Ratings](#). Figure 29 shows how a series input resistor can be added to the input to limit the input current. The added resistor contributes thermal noise at the amplifier input and its value must be kept to a minimum in noise-sensitive applications.

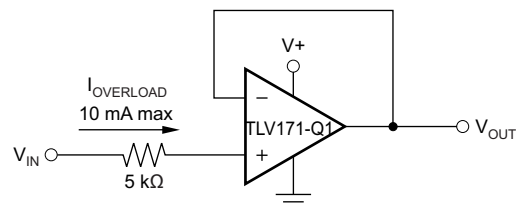

Copyright © 2017, Texas Instruments Incorporated

**Figure 29. Input Current Protection**

An ESD event produces a short duration, high-voltage pulse that is transformed into a short duration, high-current pulse as it discharges through a semiconductor device. The ESD protection circuits are designed to provide a current path around the operational amplifier core to prevent it from being damaged. The energy absorbed by the protection circuitry is then dissipated as heat.

When the operational amplifier connects into a circuit, the ESD protection components are intended to remain inactive and not become involved in the application circuit operation. However, circumstances may arise where an applied voltage exceeds the operating voltage range of a given pin. If this condition occurs, there is a risk that some of the internal ESD protection circuits may be biased on, and conduct current. Any such current flow occurs through ESD cells and rarely involves the absorption device.

If the ability of the supply to absorb this current is uncertain, external zener diodes may be added to the supply pins. The zener voltage must be selected such that the diode does not turn on during normal operation.

However, the zener voltage must be low enough so that the zener diode conducts if the supply pin begins to rise above the safe operating supply voltage level.

## 8.2 Typical Application

### 8.2.1 Capacitive Load Drive Solution Using an Isolation Resistor

The TLVx171-Q1 device can be used capacitive loads such as cable shields, reference buffers, MOSFET gates, and diodes. The circuit uses an isolation resistor ( $R_{ISO}$ ) to stabilize the output of an op amp.  $R_{ISO}$  modifies the open loop gain of the system to ensure the circuit has sufficient phase margin.

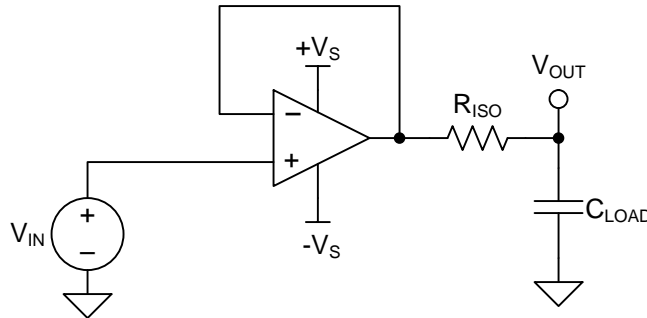

Figure 30. Unity-Gain Buffer with  $R_{ISO}$  Stability Compensation

#### 8.2.1.1 Design Requirements

The design requirements are:

- Supply voltage: 30 V ( $\pm 15$  V)
- Capacitive loads: 100 pF, 1000 pF, 0.01  $\mu$ F, 0.1  $\mu$ F, and 1  $\mu$ F
- Phase margin: 45° and 60°

#### 8.2.1.2 Detailed Design Procedure

Figure 31 shows a unity-gain buffer driving a capacitive load. Equation 1 shows the transfer function for the circuit in Figure 31. Not shown in Figure 31 is the open-loop output resistance of the op amp,  $R_o$ .

$$T(s) = \frac{1 + C_{LOAD} \times R_{ISO} \times s}{1 + (R_o + R_{ISO}) \times C_{LOAD} \times s} \quad (1)$$

The transfer function in Equation 1 has a pole and a zero. The frequency of the pole ( $f_p$ ) is determined by  $(R_o + R_{ISO})$  and  $C_{LOAD}$ . Components  $R_{ISO}$  and  $C_{LOAD}$  determine the frequency of the zero ( $f_z$ ). A stable system is obtained by selecting  $R_{ISO}$  such that the rate of closure (ROC) between the open-loop gain ( $A_{OL}$ ) and  $1/\beta$  is 20 dB/decade. Figure 31 shows the concept. The  $1/\beta$  curve for a unity-gain buffer is 0 dB.

Typical Application (continued)

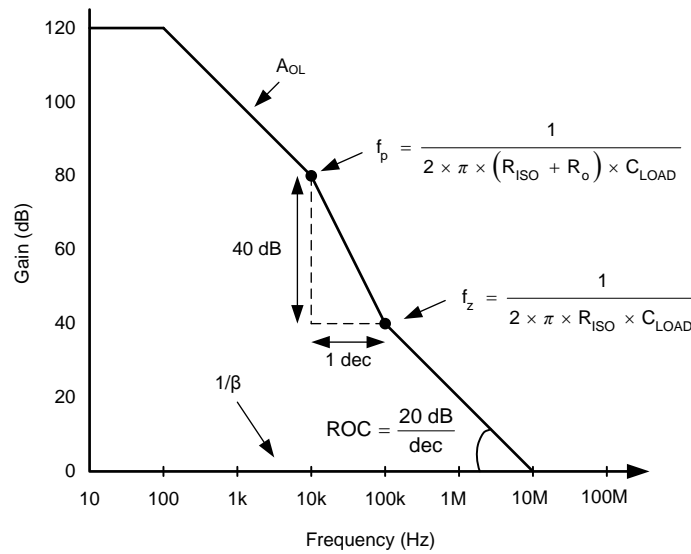

Figure 31. Unity-Gain Amplifier with R<sub>ISO</sub> Compensation

ROC stability analysis is typically simulated. The validity of the analysis depends on multiple factors, especially the accurate modeling of R<sub>o</sub>. In addition to simulating the ROC, a robust stability analysis includes a measurement of overshoot percentage and AC gain peaking of the circuit using a function generator, oscilloscope, and gain and phase analyzer. Phase margin is then calculated from these measurements. Table 4 lists the overshoot percentage and AC gain peaking that correspond to phase margins of 45° and 60°. For more details on this design and other alternative devices that can be used in place of the TLVx171-Q1, see [Capacitive Load Drive Solution using an Isolation Resistor](#).

Table 4. Phase Margin versus Overshoot and AC Gain Peaking

PHASE MARGIN	OVERSHOOT	AC GAIN PEAKING
45°	23.3%	2.35 dB
60°	8.8%	0.28 dB

8.2.1.3 Application Curve

The TLVx171-Q1 series meets the supply voltage requirements of 30 V. The TLVx171-Q1 device was tested for various capacitive loads and R<sub>ISO</sub> was adjusted to achieve an overshoot corresponding to Table 4. Figure 32 shows the test results.

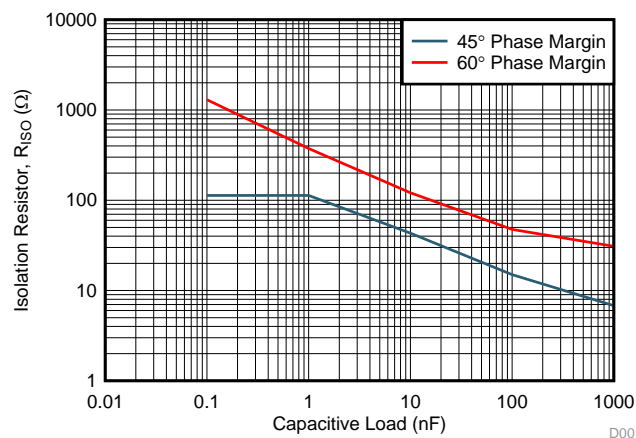

Figure 32. R<sub>ISO</sub> vs C<sub>LOAD</sub>

## 9 Power Supply Recommendations

The TLV171-Q1 family of devices is specified for operation from 4.5 V to 36 V ( $\pm 2.25$  V to  $\pm 18$  V); many specifications apply from  $-40^{\circ}\text{C}$  to  $+125^{\circ}\text{C}$ . Parameters that can exhibit significant variance with regard to operating voltage or temperature are presented in [Typical Characteristics](#).

### CAUTION

Supply voltages larger than 40 V can permanently damage the device; see the [Absolute Maximum Ratings](#) table.

Place 0.1- $\mu\text{F}$  bypass capacitors close to the power-supply pins to reduce errors coupling in from noisy or high-impedance power supplies. For detailed information on bypass capacitor placement, see [Layout](#).

## 10 Layout

### 10.1 Layout Guidelines

For best operational performance of the device, use good printed circuit board (PCB) layout practices, including:

- Noise can propagate into analog circuitry through the power pins of the circuit as a whole and op amp itself. Bypass capacitors are used to reduce the coupled noise by providing low-impedance power sources local to the analog circuitry.
  - Connect low-ESR, 0.1- $\mu\text{F}$  ceramic bypass capacitors between each supply pin and ground, placed as close to the device as possible. A single bypass capacitor from V+ to ground is applicable for single-supply applications.
- Separate grounding for analog and digital portions of circuitry is one of the simplest and most-effective methods of noise suppression. One or more layers on multilayer PCBs are usually devoted to ground planes. A ground plane helps distribute heat and reduces EMI noise pickup. Make sure to physically separate digital and analog grounds paying attention to the flow of the ground current. See [Circuit Board Layout Techniques](#) for detailed information.
- In order to reduce parasitic coupling, run the input traces as far away from the supply or output traces as possible. If it is not possible to keep them separate, it is much better to cross the sensitive trace perpendicular as opposed to in parallel with the noisy trace.
- Place the external components as close to the device as possible. As shown in [Figure 33](#), keeping RF and RG close to the inverting input minimizes parasitic capacitance.
- Keep the length of input traces as short as possible. Always remember that the input traces are the most sensitive part of the circuit.
- Consider a driven, low-impedance guard ring around the critical traces. A guard ring can significantly reduce leakage currents from nearby traces that are at different potentials.

## 10.2 Layout Example

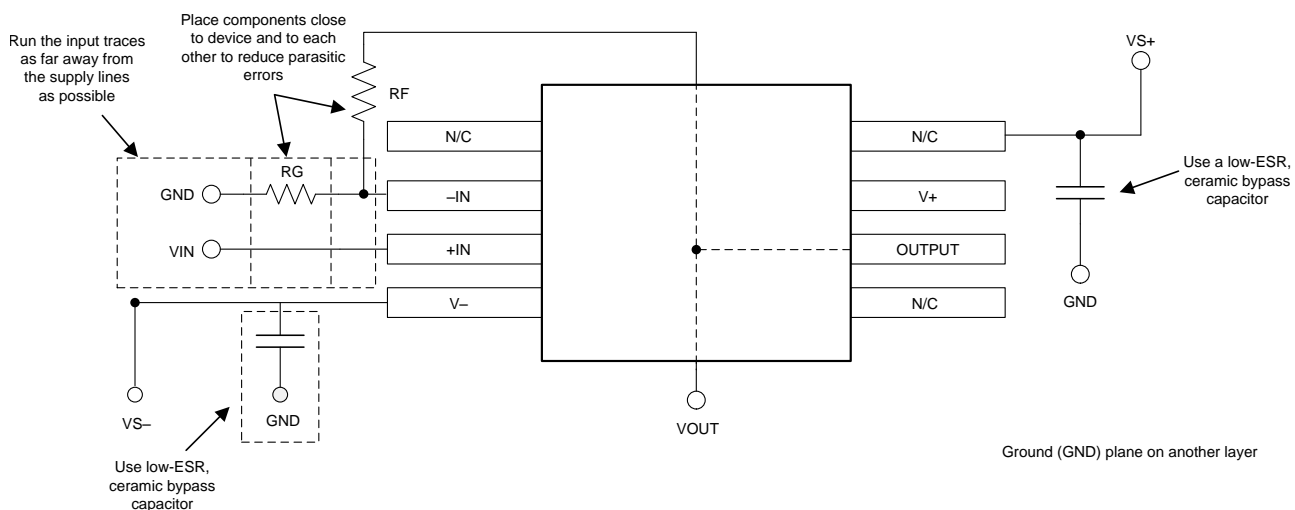

Copyright © 2017, Texas Instruments Incorporated

**Figure 33. Operational Amplifier Board Layout for Noninverting Configuration**

## 11 Device and Documentation Support

### 11.1 Documentation Support

#### 11.1.1 Related Documentation

For related documentation see the following:

- [Applications Bulletin AB-028](#) (SBOA015)
- [Capacitive Load Drive Solution using an Isolation Resistor](#) (TIDU032)
- [Circuit Board Layout Techniques](#) (SLOA089)

#### 11.2 Related Links

The table below lists quick access links. Categories include technical documents, support and community resources, tools and software, and quick access to sample or buy.

**Table 5. Related Links**

PARTS	PRODUCT FOLDER	ORDER NOW	TECHNICAL DOCUMENTS	TOOLS & SOFTWARE	SUPPORT & COMMUNITY
TLV171-Q1	<a href="#">Click here</a>	<a href="#">Click here</a>	<a href="#">Click here</a>	<a href="#">Click here</a>	<a href="#">Click here</a>
TLV2171-Q1	<a href="#">Click here</a>	<a href="#">Click here</a>	<a href="#">Click here</a>	<a href="#">Click here</a>	<a href="#">Click here</a>
TLV4171-Q1	<a href="#">Click here</a>	<a href="#">Click here</a>	<a href="#">Click here</a>	<a href="#">Click here</a>	<a href="#">Click here</a>

### 11.3 Community Resource

The following links connect to TI community resources. Linked contents are provided "AS IS" by the respective contributors. They do not constitute TI specifications and do not necessarily reflect TI's views; see TI's [Terms of Use](#).

**TI E2E™ Online Community** *TI's Engineer-to-Engineer (E2E) Community*. Created to foster collaboration among engineers. At [e2e.ti.com](http://e2e.ti.com), you can ask questions, share knowledge, explore ideas and help solve problems with fellow engineers.

**Design Support** *TI's Design Support* Quickly find helpful E2E forums along with design support tools and contact information for technical support.

### 11.4 Trademarks

E2E is a trademark of Texas Instruments.  
All other trademarks are the property of their respective owners.

### 11.5 Electrostatic Discharge Caution



These devices have limited built-in ESD protection. The leads should be shorted together or the device placed in conductive foam during storage or handling to prevent electrostatic damage to the MOS gates.

### 11.6 Glossary

[SLYZ022](#) — *TI Glossary*.

This glossary lists and explains terms, acronyms, and definitions.

## 12 Mechanical, Packaging, and Orderable Information

The following pages include mechanical, packaging, and orderable information. This information is the most current data available for the designated devices. This data is subject to change without notice and revision of this document. For browser-based versions of this data sheet, refer to the left-hand navigation.

**PACKAGING INFORMATION**

Orderable part number	Status (1)	Material type (2)	Package   Pins	Package qty   Carrier	RoHS (3)	Lead finish/ Ball material (4)	MSL rating/ Peak reflow (5)	Op temp (°C)	Part marking (6)
TLV171QDBVRQ1	Active	Production	SOT-23 (DBV)   5	3000   LARGE T&R	Yes	NIPDAU   SN	Level-2-260C-1 YEAR	-40 to 125	1CJT
TLV171QDBVRQ1.A	Active	Production	SOT-23 (DBV)   5	3000   LARGE T&R	Yes	NIPDAU	Level-2-260C-1 YEAR	-40 to 125	1CJT

(1) **Status:** For more details on status, see our [product life cycle](#).

(2) **Material type:** When designated, preproduction parts are prototypes/experimental devices, and are not yet approved or released for full production. Testing and final process, including without limitation quality assurance, reliability performance testing, and/or process qualification, may not yet be complete, and this item is subject to further changes or possible discontinuation. If available for ordering, purchases will be subject to an additional waiver at checkout, and are intended for early internal evaluation purposes only. These items are sold without warranties of any kind.

(3) **RoHS values:** Yes, No, RoHS Exempt. See the [TI RoHS Statement](#) for additional information and value definition.

(4) **Lead finish/Ball material:** Parts may have multiple material finish options. Finish options are separated by a vertical ruled line. Lead finish/Ball material values may wrap to two lines if the finish value exceeds the maximum column width.

(5) **MSL rating/Peak reflow:** The moisture sensitivity level ratings and peak solder (reflow) temperatures. In the event that a part has multiple moisture sensitivity ratings, only the lowest level per JEDEC standards is shown. Refer to the shipping label for the actual reflow temperature that will be used to mount the part to the printed circuit board.

(6) **Part marking:** There may be an additional marking, which relates to the logo, the lot trace code information, or the environmental category of the part.

Multiple part markings will be inside parentheses. Only one part marking contained in parentheses and separated by a "-" will appear on a part. If a line is indented then it is a continuation of the previous line and the two combined represent the entire part marking for that device.

**Important Information and Disclaimer:**The information provided on this page represents TI's knowledge and belief as of the date that it is provided. TI bases its knowledge and belief on information provided by third parties, and makes no representation or warranty as to the accuracy of such information. Efforts are underway to better integrate information from third parties. TI has taken and continues to take reasonable steps to provide representative and accurate information but may not have conducted destructive testing or chemical analysis on incoming materials and chemicals. TI and TI suppliers consider certain information to be proprietary, and thus CAS numbers and other limited information may not be available for release.

In no event shall TI's liability arising out of such information exceed the total purchase price of the TI part(s) at issue in this document sold by TI to Customer on an annual basis.

**OTHER QUALIFIED VERSIONS OF TLV171-Q1 :**

- Catalog : [TLV171](#)

NOTE: Qualified Version Definitions:

- Catalog - TI's standard catalog product

**TAPE AND REEL INFORMATION**

**QUADRANT ASSIGNMENTS FOR PIN 1 ORIENTATION IN TAPE**



\*All dimensions are nominal

Device	Package Type	Package Drawing	Pins	SPQ	Reel Diameter (mm)	Reel Width W1 (mm)	A0 (mm)	B0 (mm)	K0 (mm)	P1 (mm)	W (mm)	Pin1 Quadrant
TLV171QDBVRQ1	SOT-23	DBV	5	3000	180.0	8.4	3.23	3.17	1.37	4.0	8.0	Q3
TLV171QDBVRQ1	SOT-23	DBV	5	3000	180.0	8.4	3.2	3.2	1.4	4.0	8.0	Q3

**TAPE AND REEL BOX DIMENSIONS**

\*All dimensions are nominal

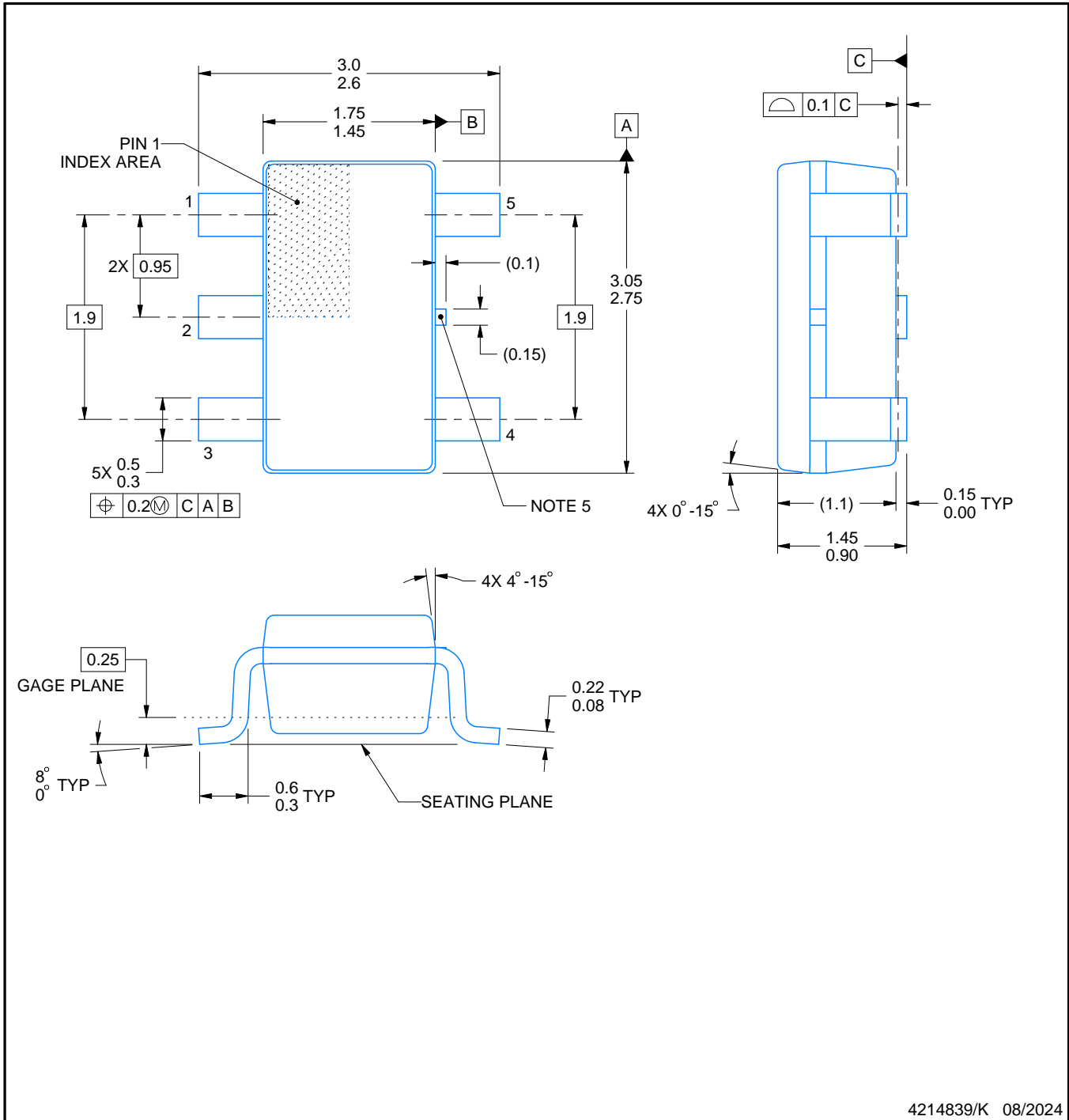
Device	Package Type	Package Drawing	Pins	SPQ	Length (mm)	Width (mm)	Height (mm)
TLV171QDBVRQ1	SOT-23	DBV	5	3000	213.0	191.0	35.0
TLV171QDBVRQ1	SOT-23	DBV	5	3000	210.0	185.0	35.0



4214839/K 08/2024

NOTES:

1. All linear dimensions are in millimeters. Any dimensions in parenthesis are for reference only. Dimensioning and tolerancing per ASME Y14.5M.
2. This drawing is subject to change without notice.
3. Reference JEDEC MO-178.
4. Body dimensions do not include mold flash, protrusions, or gate burrs. Mold flash, protrusions, or gate burrs shall not exceed 0.25 mm per side.
5. Support pin may differ or may not be present.

# EXAMPLE BOARD LAYOUT

DBV0005A

SOT-23 - 1.45 mm max height

SMALL OUTLINE TRANSISTOR



LAND PATTERN EXAMPLE  
EXPOSED METAL SHOWN  
SCALE:15X



SOLDER MASK DETAILS

4214839/K 08/2024

NOTES: (continued)

- 6. Publication IPC-7351 may have alternate designs.
- 7. Solder mask tolerances between and around signal pads can vary based on board fabrication site.

# EXAMPLE STENCIL DESIGN

DBV0005A

SOT-23 - 1.45 mm max height

SMALL OUTLINE TRANSISTOR



SOLDER PASTE EXAMPLE  
BASED ON 0.125 mm THICK STENCIL  
SCALE:15X

4214839/K 08/2024

NOTES: (continued)

8. Laser cutting apertures with trapezoidal walls and rounded corners may offer better paste release. IPC-7525 may have alternate design recommendations.
9. Board assembly site may have different recommendations for stencil design.

## IMPORTANT NOTICE AND DISCLAIMER

TI PROVIDES TECHNICAL AND RELIABILITY DATA (INCLUDING DATASHEETS), DESIGN RESOURCES (INCLUDING REFERENCE DESIGNS), APPLICATION OR OTHER DESIGN ADVICE, WEB TOOLS, SAFETY INFORMATION, AND OTHER RESOURCES "AS IS" AND WITH ALL FAULTS, AND DISCLAIMS ALL WARRANTIES, EXPRESS AND IMPLIED, INCLUDING WITHOUT LIMITATION ANY IMPLIED WARRANTIES OF MERCHANTABILITY, FITNESS FOR A PARTICULAR PURPOSE OR NON-INFRINGEMENT OF THIRD PARTY INTELLECTUAL PROPERTY RIGHTS.

These resources are intended for skilled developers designing with TI products. You are solely responsible for (1) selecting the appropriate TI products for your application, (2) designing, validating and testing your application, and (3) ensuring your application meets applicable standards, and any other safety, security, regulatory or other requirements.

These resources are subject to change without notice. TI grants you permission to use these resources only for development of an application that uses the TI products described in the resource. Other reproduction and display of these resources is prohibited. No license is granted to any other TI intellectual property right or to any third party intellectual property right. TI disclaims responsibility for, and you fully indemnify TI and its representatives against any claims, damages, costs, losses, and liabilities arising out of your use of these resources.

TI's products are provided subject to [TI's Terms of Sale](#), [TI's General Quality Guidelines](#), or other applicable terms available either on [ti.com](http://ti.com) or provided in conjunction with such TI products. TI's provision of these resources does not expand or otherwise alter TI's applicable warranties or warranty disclaimers for TI products. Unless TI explicitly designates a product as custom or customer-specified, TI products are standard, catalog, general purpose devices.

TI objects to and rejects any additional or different terms you may propose.

Copyright © 2026, Texas Instruments Incorporated

Last updated 10/2025