

TLV2241, TLV2242, TLV2244 FAMILY OF 1- μ A/Ch RAIL-TO-RAIL INPUT/OUTPUT OPERATIONAL AMPLIFIERS

SLOS329C – JULY 2000 REVISED - NOVEMBER 2000

- **Micropower Operation . . . 1 μ A/Channel**
- **Rail-to-Rail Input/Output**
- **Gain Bandwidth Product . . . 5.5 kHz**
- **Supply Voltage Range . . . 2.5 V to 12 V**
- **Specified Temperature Range**
 - $T_A = 0^\circ\text{C}$ to 70°C . . . **Commercial Grade**
 - $T_A = -40^\circ\text{C}$ to 125°C . . . **Industrial Grade**
- **Ultrasmall Packaging**
 - **5-Pin SOT-23 (TLV2241)**
 - **8-Pin MSOP (TLV2242)**
- **Universal OpAmp EVM**

description

The TLV224x family of single-supply operational amplifiers offers very low supply current of only 1 μ A per channel.

The low supply current is coupled with extremely low input bias currents enabling them to be used with mega- Ω resistors making them ideal for portable, long active life, applications. DC accuracy is ensured with a low typical offset voltage as low as 600 μ V, CMRR of 100 dB, and minimum open loop gain of 100 V/mV at 2.7 V.

The maximum recommended supply voltage is as high as 12 V and ensured operation down to 2.5 V, with electrical characteristics specified at 2.7 V, 5 V and 12 V. The 2.5-V operation makes it compatible with Li-Ion battery-powered systems and many micropower microcontrollers available today including TI's MSP430.

Operational Amplifier



SUPPLY CURRENT
vs
SUPPLY VOLTAGE

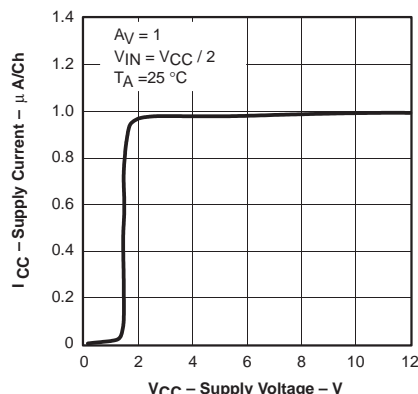

FAMILY PACKAGE TABLE

| DEVICE | NO. OF Ch | PACKAGE TYPES | | | | | UNIVERSAL EVM |
|---------|-----------|---------------|------|--------|-------|------|---|
| | | PDIP | SOIC | SOT-23 | TSSOP | MSOP | |
| TLV2241 | 1 | 8 | 8 | 5 | — | — | Refer to the EVM Selection Guide (Lit# SLOU060) |
| TLV2242 | 2 | 8 | 8 | — | — | 8 | |
| TLV2244 | 4 | 14 | 14 | — | 14 | — | |

SELECTION OF SINGLE SUPPLY OPERATIONAL AMPLIFIER PRODUCTS†

| DEVICE | V _{DD} (V) | V _{IO} (mV) | BW (MHz) | SLEW RATE (V/ μ s) | I _{DD} (PER CHANNEL) (μ A) | RAIL-TO-RAIL |
|----------|---------------------|----------------------|----------|------------------------|--|--------------|
| TLV240x‡ | 2.5–16 | 0.390 | 0.005 | 0.002 | 0.880 | I/O |
| TLV224x | 2.5–12 | 0.600 | 0.005 | 0.002 | 1 | I/O |
| TLV2211 | 2.7–10 | 0.450 | 0.065 | 0.025 | 13 | O |
| TLV245x | 2.7–6 | 0.020 | 0.22 | 0.110 | 23 | I/O |
| TLV225x | 2.7–8 | 0.200 | 0.2 | 0.12 | 35 | O |

† All specifications are typical values measured at 5 V.

‡ This device also offers 18-V reverse battery protection and 5-V over-the-rail operation on the inputs.



Please be aware that an important notice concerning availability, standard warranty, and use in critical applications of Texas Instruments semiconductor products and disclaimers thereto appears at the end of this data sheet.

PRODUCTION DATA information is current as of publication date. Products conform to specifications per the terms of Texas Instruments standard warranty. Production processing does not necessarily include testing of all parameters.

 **TEXAS
INSTRUMENTS**

POST OFFICE BOX 655303 • DALLAS, TEXAS 75265

Copyright © 2000, Texas Instruments Incorporated

TLV2241, TLV2242, TLV2244

FAMILY OF 1- μ A/Ch RAIL-TO-RAIL INPUT/OUTPUT OPERATIONAL AMPLIFIERS

SLOS329C – JULY 2000 REVISED - NOVEMBER 2000

TLV2241 AVAILABLE OPTIONS

| T _A | V _{IOmax} AT 25°C | PACKAGED DEVICES | | | |
|----------------|-------------------------------|-----------------------|------------------|---------|--------------------|
| | | SMALL OUTLINE† (D) | SOT-23‡ (DBV) | SYMBOLS | PLASTIC DIP (P) |
| 0°C to 70°C | 3000 μ V | TLV2241CD | — | — | — |
| –40°C to 125°C | | TLV2241ID | TLV2241DBV | VBEI | TLV2241IP |

† This package is available taped and reeled. To order this packaging option, add an R suffix to the part number (e.g., TLV2241CDR).

‡ This package is available in a 250 piece mini-reel. To order this package, add a T suffix to the part number (e.g., TLV2241DBVT). This package is also available in a 3000 piece reel, add a R suffix to the part number (e.g., TLV2241DBVR).

TLV2242 AVAILABLE OPTIONS

| T _A | V _{IOmax} AT 25°C | PACKAGED DEVICES | | | |
|----------------|-------------------------------|-----------------------|----------------|---------|--------------------|
| | | SMALL OUTLINE† (D) | MSOP† (DGK) | SYMBOLS | PLASTIC DIP (P) |
| 0°C to 70°C | 3000 μ V | TLV2242CD | — | — | — |
| –40°C to 125°C | | TLV2242ID | TLV2242IDGK | xxTIALE | TLV2242IP |

† This package is available taped and reeled. To order this packaging option, add an R suffix to the part number (e.g., TLV2242CDR).

TLV2244 AVAILABLE OPTIONS

| T _A | V _{IOmax} AT 25°C | PACKAGED DEVICES | | |
|----------------|-------------------------------|-----------------------|--------------------|---------------|
| | | SMALL OUTLINE† (D) | PLASTIC DIP (N) | TSSOP (PW) |
| 0°C to 70°C | 3000 μ V | TLV2244CD | — | — |
| –40°C to 125°C | | TLV2244ID | TLV2244IN | TLV2244IPW |

† This package is available taped and reeled. To order this packaging option, add an R suffix to the part number (e.g., TLV2244CDR).

TLV224x PACKAGE PINOUTS

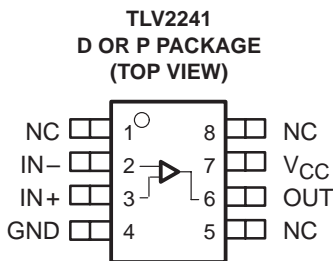
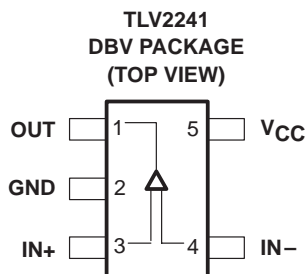

NC – No internal connection

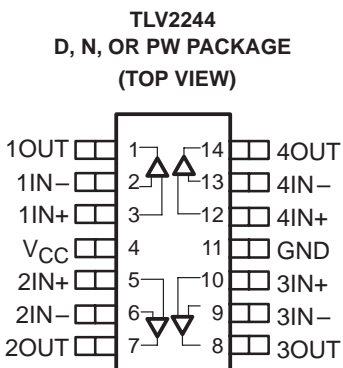
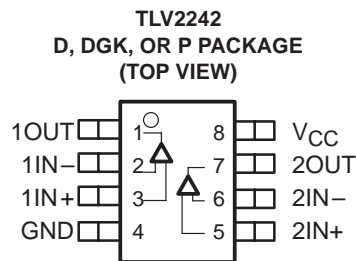

TLV2241, TLV2242, TLV2244
FAMILY OF 1- μ A/Ch RAIL-TO-RAIL INPUT/OUTPUT
OPERATIONAL AMPLIFIERS

SLOS329C – JULY 2000 REVISED - NOVEMBER 2000

absolute maximum ratings over operating free-air temperature range (unless otherwise noted)†

| | |
|--|------------------------------|
| Supply voltage, V_{CC} (see Note 1) | 16.5 V |
| Differential input voltage, V_{ID} | $\pm V_{CC}$ |
| Input current, I_I (any input) | ± 10 mA |
| Output current, I_O | ± 10 mA |
| Continuous total power dissipation | See Dissipation Rating Table |
| Operating free-air temperature range, T_A : C suffix | 0°C to 70°C |
| I suffix | –40°C to 125°C |
| Maximum junction temperature, T_J | 150°C |
| Storage temperature range, T_{stg} | –65°C to 150°C |
| Lead temperature 1,6 mm (1/16 inch) from case for 10 seconds | 260°C |

† Stresses beyond those listed under “absolute maximum ratings” may cause permanent damage to the device. These are stress ratings only, and functional operation of the device at these or any other conditions beyond those indicated under “recommended operating conditions” is not implied. Exposure to absolute-maximum-rated conditions for extended periods may affect device reliability.

NOTE 1: All voltage values, except differential voltages, are with respect to GND

DISSIPATION RATING TABLE

| PACKAGE | Θ_{JC} (°C/W) | Θ_{JA} (°C/W) | $T_A \leq 25^\circ\text{C}$ POWER RATING | $T_A = 125^\circ\text{C}$ POWER RATING |
|---------|-------------------------|-------------------------|---|---|
| D (8) | 38.3 | 176 | 710 mW | 142 mW |
| D (14) | 26.9 | 122.6 | 1022 mW | 204.4 mW |
| DBV (5) | 55 | 324.1 | 385 mW | 77.1 mW |
| DGK (8) | 54.2 | 259.9 | 481 mW | 96.2 mW |
| N (14) | 32 | 78 | 1600 mW | 320.5 mW |
| P (8) | 41 | 104 | 1200 mW | 240.4 mW |
| PW (14) | 29.3 | 173.6 | 720 mW | 144 mW |

recommended operating conditions

| | | MIN | MAX | UNIT |
|--|---------------|------------|----------|------|
| Supply voltage, V_{CC} | Single supply | 2.5 | 12 | V |
| | Split supply | ± 1.25 | ± 6 | |
| Common-mode input voltage range, V_{ICR} | | 0 | V_{CC} | V |
| Operating free-air temperature, T_A | C-suffix | 0 | 70 | °C |
| | I-suffix | –40 | 125 | |

TLV2241, TLV2242, TLV2244

FAMILY OF 1- μ A/Ch RAIL-TO-RAIL INPUT/OUTPUT OPERATIONAL AMPLIFIERS

SLOS329C – JULY 2000 REVISED - NOVEMBER 2000

electrical characteristics at recommended operating conditions, $V_{CC} = 2.7, 5 \text{ V}$, and 12 V (unless otherwise noted)†‡

dc performance

| PARAMETER | TEST CONDITIONS | T_A † | MIN | TYP | MAX | UNIT |
|---|--|---|------------|------|------|------------------------------|
| V_{IO} Input offset voltage | $V_O = V_{CC}/2 \text{ V}$, $V_{IC} = V_{CC}/2 \text{ V}$, $R_S = 50 \Omega$ | 25°C | 600 | 3000 | | μV |
| | | Full range | | 4500 | | |
| αV_{IO} Offset voltage drift | | 25°C | 3 | | | $\mu\text{V}/^\circ\text{C}$ |
| CMRR Common-mode rejection ratio | $V_{IC} = 0 \text{ to } V_{CC}$, $R_S = 50 \Omega$ | $V_{CC} = 2.7 \text{ V}$ | 25°C | 55 | 100 | dB |
| | | | Full range | 50 | | |
| | | $V_{CC} = 5 \text{ V}$ | 25°C | 60 | 100 | |
| | | | Full range | 53 | | |
| | | $V_{CC} = 12 \text{ V}$ | 25°C | 60 | 100 | |
| | | | Full range | 55 | | |
| AVD Large-signal differential voltage amplification | $V_{CC} = 2.7 \text{ V}$, $V_{O(pp)} = 1 \text{ V}$, $R_L = 500 \text{ k}\Omega$ | 25°C | 100 | 400 | V/mV | |
| | | | Full range | 30 | | |
| | | $V_{CC} = 5 \text{ V}$, $V_{O(pp)} = 3 \text{ V}$, $R_L = 500 \text{ k}\Omega$ | 25°C | 250 | | 1000 |
| | | | Full range | 100 | | |
| | | $V_{CC} = 12 \text{ V}$, $V_{O(pp)} = 6 \text{ V}$, $R_L = 500 \text{ k}\Omega$ | 25°C | 700 | | 1500 |
| | | | Full range | 120 | | |

† Full range is 0°C to 70°C for the C suffix and -40°C to 125°C for the I suffix. If not specified, full range is -40°C to 125°C.

input characteristics

| PARAMETER | TEST CONDITIONS | T_A † | MIN | TYP | MAX | UNIT |
|--|---|------------|-----|------|-----|------------------|
| I_{IO} Input offset current | $V_O = V_{CC}/2 \text{ V}$, $V_{IC} = V_{CC}/2 \text{ V}$, $R_S = 50 \Omega$ | 25°C | 25 | 250 | | pA |
| | | Full range | | 300 | | |
| | | | | 400 | | |
| I_{IB} Input bias current | $V_O = V_{CC}/2 \text{ V}$, $V_{IC} = V_{CC}/2 \text{ V}$, $R_S = 50 \Omega$ | 25°C | 100 | 500 | | pA |
| | | Full range | | 550 | | |
| | | | | 1000 | | |
| $r_{i(d)}$ Differential input resistance | | 25°C | 300 | | | $\text{M}\Omega$ |
| $C_{i(c)}$ Common-mode input capacitance | $f = 100 \text{ kHz}$ | 25°C | 3 | | | pF |

† Full range is 0°C to 70°C for the C suffix and -40°C to 125°C for the I suffix. If not specified, full range is -40°C to 125°C.

‡ Specifications at 5 V are ensured by design and device testing at 2.7 V and 12 V.



TLV2241, TLV2242, TLV2244
FAMILY OF 1- μ A/Ch RAIL-TO-RAIL INPUT/OUTPUT
OPERATIONAL AMPLIFIERS

SLOS329C – JULY 2000 REVISED - NOVEMBER 2000

electrical characteristics at recommended operating conditions, $V_{CC} = 2.7, 5 \text{ V}$, and 12 V (unless otherwise noted)[†] (continued)

output characteristics

| PARAMETER | TEST CONDITIONS | T_A [†] | MIN | TYP | MAX | UNIT |
|------------------------------------|---|--------------------------|------------|-----------|-------|---------------|
| V_{OH} High-level output voltage | $V_{IC} = V_{CC}/2$, $I_{OH} = -2 \mu\text{A}$ | $V_{CC} = 2.7 \text{ V}$ | 25°C | 2.65 | 2.68 | V |
| | | | Full range | 2.63 | | |
| | | $V_{CC} = 5 \text{ V}$ | 25°C | 4.95 | 4.98 | |
| | | | Full range | 4.93 | | |
| | | $V_{CC} = 12 \text{ V}$ | 25°C | 11.95 | 11.98 | |
| | | | Full range | 11.93 | | |
| | $V_{IC} = V_{CC}/2$, $I_{OH} = -50 \mu\text{A}$ | $V_{CC} = 2.7 \text{ V}$ | 25°C | 2.62 | 2.65 | |
| | | | Full range | 2.6 | | |
| | | $V_{CC} = 5 \text{ V}$ | 25°C | 4.92 | 4.95 | |
| | | | Full range | 4.9 | | |
| | | $V_{CC} = 12 \text{ V}$ | 25°C | 11.92 | 11.95 | |
| | | | Full range | 11.9 | | |
| V_{OL} Low-level output voltage | $V_{IC} = V_{CC}/2$, $I_{OL} = 2 \mu\text{A}$ | 25°C | | 90 | 150 | mV |
| | | Full range | | | 180 | |
| | $V_{IC} = V_{CC}/2$, $I_{OL} = 50 \mu\text{A}$ | 25°C | | 180 | 230 | |
| | | Full range | | | 260 | |
| I_O Output current | $V_O = 0.5 \text{ V}$ from rail | 25°C | | ± 200 | | μA |

[†] Full range is 0°C to 70°C for the C suffix and -40°C to 125°C for the I suffix. If not specified, full range is -40°C to 125°C.

power supply

| PARAMETER | TEST CONDITIONS | T_A [†] | MIN | TYP | MAX | UNIT |
|--|--|---|------------|------|------|------|
| I_{CC} Supply current (per channel) | $V_O = V_{CC}/2$ | $V_{CC} = 2.7 \text{ V}$ or 5 V | 25°C | 980 | 1200 | nA |
| | | | Full range | | 1500 | |
| | | $V_{CC} = 12 \text{ V}$ | 25°C | 1000 | 1250 | |
| | | | Full range | | 1550 | |
| PSRR Power supply rejection ratio ($\Delta V_{CC}/\Delta V_{IO}$) | $V_{CC} = 2.7$ to 5 V , $V_{IC} = V_{CC}/2 \text{ V}$, No load, | TLV224xC | 25°C | 70 | 100 | dB |
| | | | Full range | 65 | | dB |
| | | TLV224xI | 25°C | 60 | | dB |
| | $V_{CC} = 5$ to 12 V , $V_{IC} = V_{CC}/2 \text{ V}$, No load | 25°C | 70 | 100 | dB | |
| | | Full range | 70 | | dB | |

[†] Full range is 0°C to 70°C for the C suffix and -40°C to 125°C for the I suffix. If not specified, full range is -40°C to 125°C.

[‡] Specifications at 5 V are ensured by design and device testing at 2.7 V and 12 V.



TLV2241, TLV2242, TLV2244
FAMILY OF 1- μ A/Ch RAIL-TO-RAIL INPUT/OUTPUT
OPERATIONAL AMPLIFIERS

SLOS329C – JULY 2000 REVISED - NOVEMBER 2000

electrical characteristics at recommended operating conditions, $V_{CC} = 2.7, 5 \text{ V}$, and 12 V (unless otherwise noted)† (continued)

dynamic performance

| PARAMETER | | TEST CONDITIONS | | T_A | MIN | TYP | MAX | UNIT | |
|-----------|-------------------------|--|--|--------------------|-----|------|-----|------|------|
| UGBW | Unity gain bandwidth | $R_L = 500 \text{ k}\Omega$, | $C_L = 100 \text{ pF}$ | 25°C | | 5.5 | | kHz | |
| SR | Slew rate at unity gain | $V_{O(pp)} = 0.8 \text{ V}$, | $R_L = 500 \text{ k}\Omega$, $C_L = 100 \text{ pF}$ | 25°C | | 2 | | V/ms | |
| ϕM | Phase margin | $R_L = 500 \text{ k}\Omega$, $C_L = 100 \text{ pF}$ | | 25°C | | | | 60 | |
| | Gain margin | | | | | | | 15 | dB |
| t_s | Settling time | $V_{CC} = 2.7 \text{ or } 5 \text{ V}$, | | 25°C | | 1.84 | | ms | |
| | | $V(\text{STEP})_{PP} = 1 \text{ V}$, | $C_L = 100 \text{ pF}$, | | | | | | 0.1% |
| | | $A_V = -1$, | $R_L = 100 \text{ k}\Omega$ | | | | | | |
| | | $V_{CC} = 12 \text{ V}$, | | | | 6.1 | | | |
| | | $V(\text{STEP})_{PP} = 1 \text{ V}$, | $C_L = 100 \text{ pF}$, | | | | | | |
| | | $A_V = -1$, | $R_L = 100 \text{ k}\Omega$ | | | 32 | | | |

noise/distortion performance

| PARAMETER | | TEST CONDITIONS | T_A | MIN | TYP | MAX | UNIT |
|-----------|--------------------------------|----------------------|--------------------|-----|-----|-----|------------------------------|
| V_n | Equivalent input noise voltage | $f = 10 \text{ Hz}$ | 25°C | | | | 800 |
| | | $f = 100 \text{ Hz}$ | | | | | 500 |
| I_n | Equivalent input noise current | $f = 100 \text{ Hz}$ | | | | | 8 |
| | | | | | | | $\text{fA}/\sqrt{\text{Hz}}$ |

† Specifications at 5 V are ensured by design and device testing at 2.7 V and 12 V.



TLV2241, TLV2242, TLV2244
**FAMILY OF 1- μ A/Ch RAIL-TO-RAIL INPUT/OUTPUT
 OPERATIONAL AMPLIFIERS**

SLOS329C – JULY 2000 REVISED - NOVEMBER 2000

TYPICAL CHARACTERISTICS

Table of Graphs

| | | | FIGURE |
|-------------|---------------------------------------|------------------------------|---------------|
| V_{IO} | Input offset voltage | vs Common-mode input voltage | 1, 2, 3 |
| I_{IB} | Input bias current | vs Free-air temperature | 4, 6, 8 |
| | | vs Common-mode input voltage | 5, 7, 9 |
| I_{IO} | Input offset current | vs Free-air temperature | 4, 6, 8 |
| | | vs Common-mode input voltage | 5, 7, 9 |
| CMRR | Common-mode rejection ratio | vs Frequency | 10 |
| V_{OH} | High-level output voltage | vs High-level output current | 11, 13, 15 |
| V_{OL} | Low-level output voltage | vs Low-level output current | 12, 14, 16 |
| $V_{O(PP)}$ | Output voltage peak-to-peak | vs Frequency | 17 |
| Z_o | Output impedance | vs Frequency | 18 |
| I_{CC} | Supply current | vs Supply voltage | 19 |
| PSRR | Power supply rejection ratio | vs Frequency | 20 |
| A_{VD} | Differential voltage gain | vs Frequency | 21 |
| | Phase | vs Frequency | 21 |
| | Gain-bandwidth product | vs Supply voltage | 22 |
| SR | Slew rate | vs Free-air temperature | 23 |
| ϕ_m | Phase margin | vs Capacitive load | 24 |
| | Gain margin | vs Capacitive load | 25 |
| | Voltage noise over a 10 Second Period | | 26 |
| | Large-signal voltage follower | | 27, 28, 29 |
| | Small-signal voltage follower | | 30 |
| | Large-signal inverting pulse response | | 31, 32, 33 |
| | Small-signal inverting pulse response | | 34 |
| | Crosstalk | vs Frequency | 35 |

TLV2241, TLV2242, TLV2244 FAMILY OF 1- μ A/Ch RAIL-TO-RAIL INPUT/OUTPUT OPERATIONAL AMPLIFIERS

SLOS329C – JULY 2000 REVISED – NOVEMBER 2000

TYPICAL CHARACTERISTICS

**INPUT OFFSET VOLTAGE
vs
COMMON-MODE INPUT
VOLTAGE**

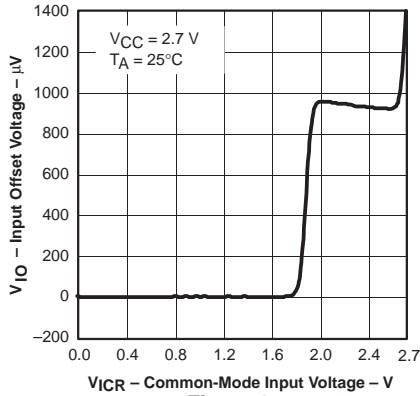

Figure 1

**INPUT OFFSET VOLTAGE
vs
COMMON-MODE INPUT
VOLTAGE**

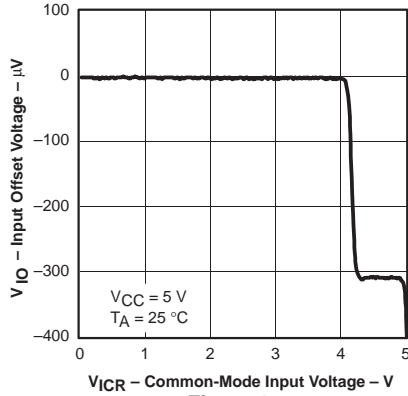

Figure 2

**INPUT OFFSET VOLTAGE
vs
COMMON-MODE INPUT
VOLTAGE**

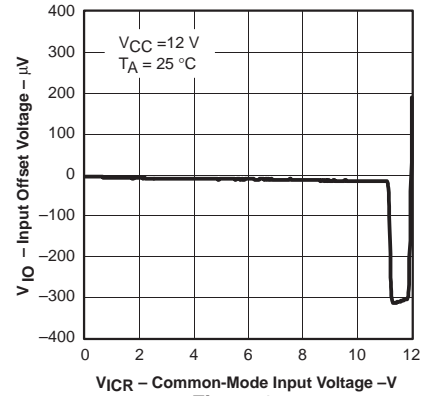

Figure 3

**INPUT BIAS / OFFSET CURRENT
vs
FREE-AIR TEMPERATURE**



Figure 4

**INPUT BIAS / OFFSET CURRENT
vs
COMMON MODE INPUT
VOLTAGE**



Figure 5

**INPUT BIAS / OFFSET CURRENT
vs
FREE-AIR TEMPERATURE**

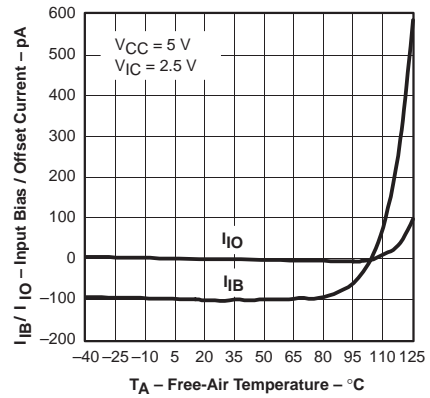

Figure 6

**INPUT BIAS / OFFSET CURRENT
vs
COMMON-MODE INPUT
VOLTAGE**



Figure 7

**INPUT BIAS / OFFSET CURRENT
vs
FREE-AIR TEMPERATURE**



Figure 8

**INPUT BIAS / OFFSET CURRENT
vs
COMMON-MODE INPUT
VOLTAGE**

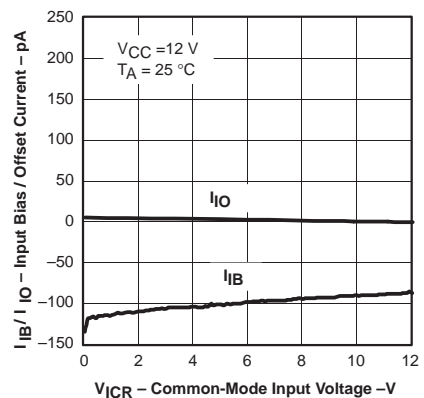

Figure 9



TYPICAL CHARACTERISTICS

COMMON-MODE REJECTION RATIO
 vs
 FREQUENCY



Figure 10

HIGH-LEVEL OUTPUT VOLTAGE
 vs
 HIGH-LEVEL OUTPUT CURRENT



Figure 11

LOW-LEVEL OUTPUT VOLTAGE
 vs
 LOW-LEVEL OUTPUT CURRENT

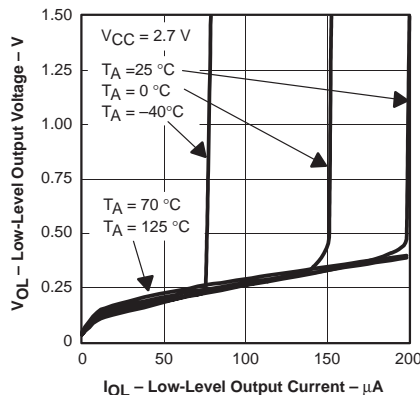

Figure 12

HIGH-LEVEL OUTPUT VOLTAGE
 vs
 HIGH-LEVEL OUTPUT CURRENT

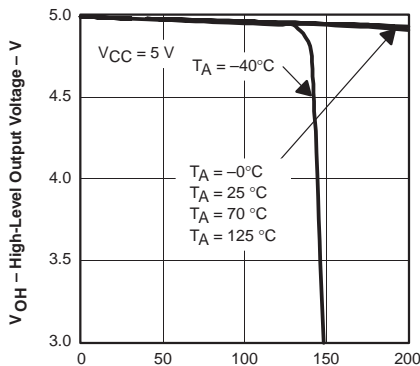

Figure 13

LOW-LEVEL OUTPUT VOLTAGE
 vs
 LOW-LEVEL OUTPUT CURRENT



Figure 14

HIGH-LEVEL OUTPUT VOLTAGE
 vs
 HIGH-LEVEL OUTPUT CURRENT

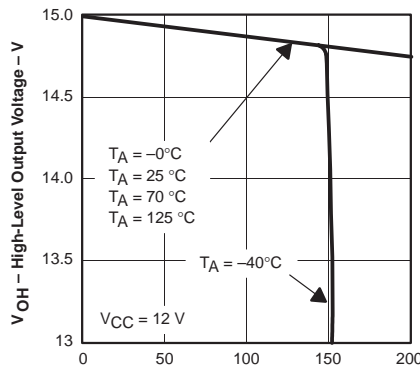

Figure 15

LOW-LEVEL OUTPUT VOLTAGE
 vs
 LOW-LEVEL OUTPUT CURRENT

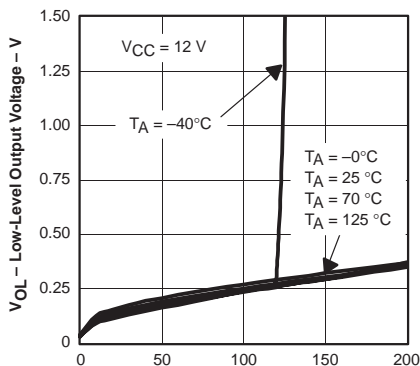

Figure 16

OUTPUT VOLTAGE
 PEAK-TO-PEAK
 vs
 FREQUENCY

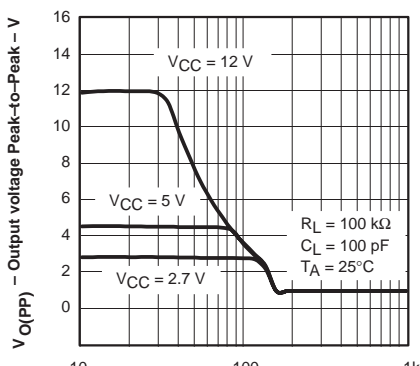

Figure 17

OUTPUT IMPEDANCE
 vs
 FREQUENCY

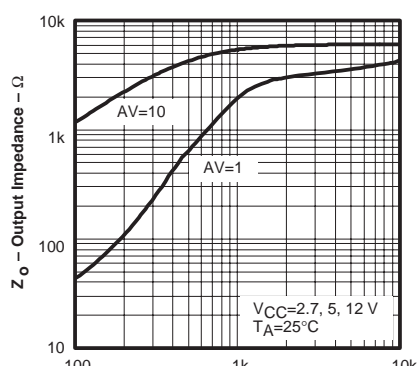
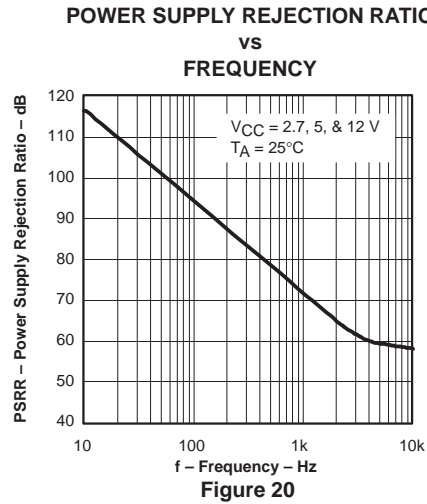

Figure 18

TLV2241, TLV2242, TLV2244 FAMILY OF 1- μ A/Ch RAIL-TO-RAIL INPUT/OUTPUT OPERATIONAL AMPLIFIERS

SLOS329C – JULY 2000 REVISED - NOVEMBER 2000

TYPICAL CHARACTERISTICS



TYPICAL CHARACTERISTICS

GAIN MARGIN
 VS
 CAPACITIVE LOAD

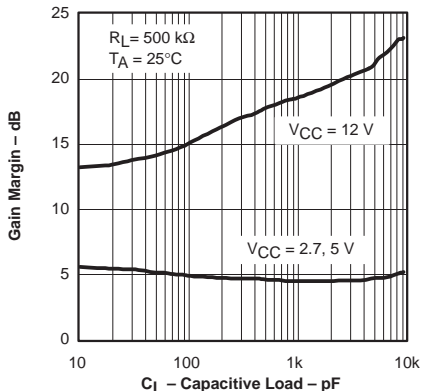

Figure 25

VOLTAGE NOISE
 OVER A 10 SECOND PERIOD

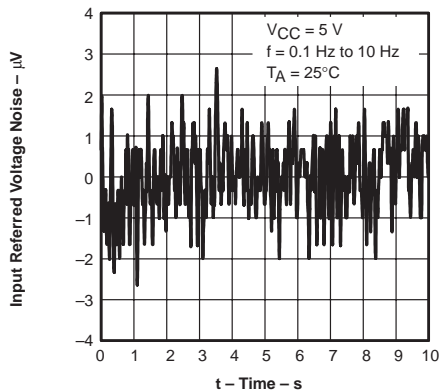

Figure 26

LARGE SIGNAL FOLLOWER
 PULSE RESPONSE

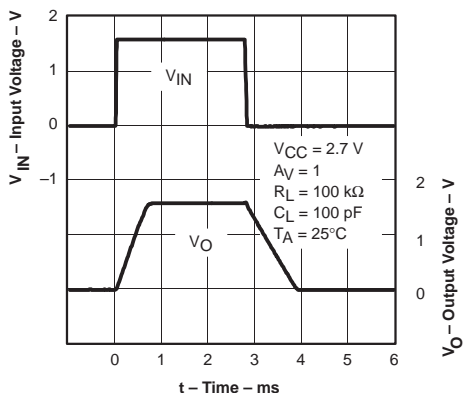

Figure 27

LARGE SIGNAL FOLLOWER
 PULSE RESPONSE

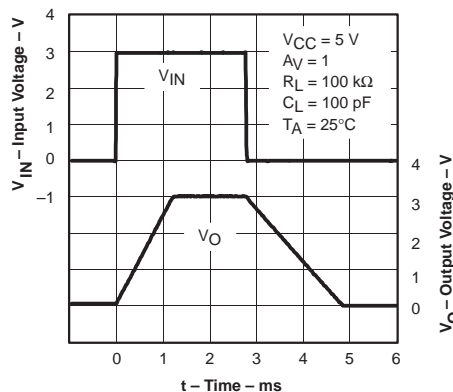

Figure 28

LARGE SIGNAL FOLLOWER
 PULSE RESPONSE



Figure 29

SMALL SIGNAL FOLLOWER
 PULSE RESPONSE

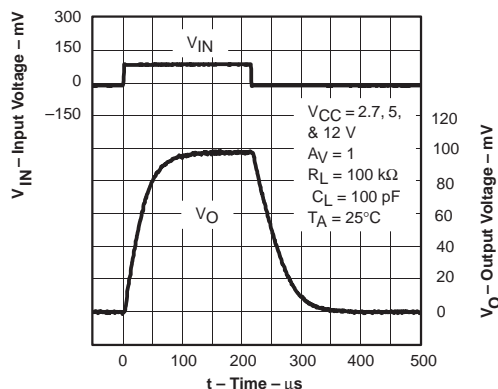

Figure 30

TLV2241, TLV2242, TLV2244 FAMILY OF 1- μ A/Ch RAIL-TO-RAIL INPUT/OUTPUT OPERATIONAL AMPLIFIERS

SLOS329C – JULY 2000 REVISED - NOVEMBER 2000

TYPICAL CHARACTERISTICS

**LARGE SIGNAL INVERTING
PULSE RESPONSE**

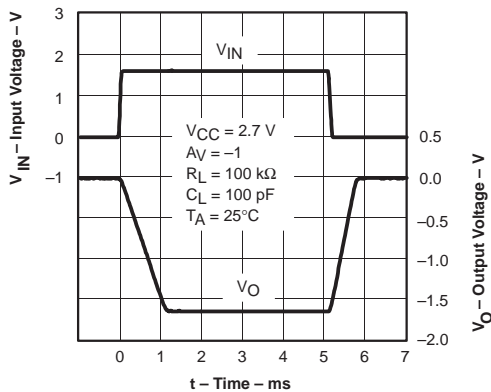

Figure 31

**LARGE SIGNAL INVERTING
PULSE RESPONSE**

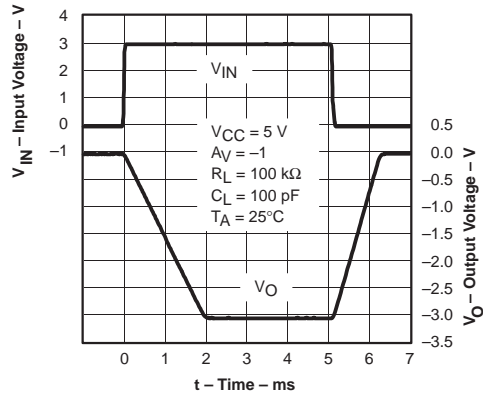

Figure 32

**LARGE SIGNAL INVERTING
PULSE RESPONSE**

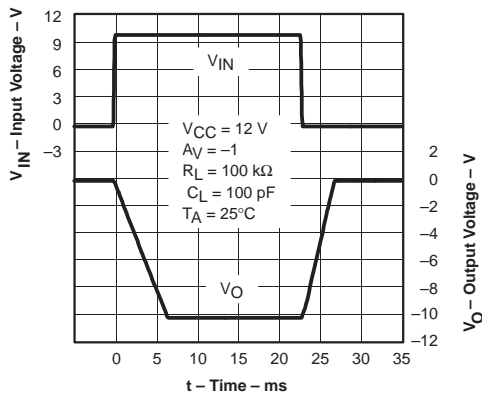

Figure 33

**SMALL SIGNAL INVERTING
PULSE RESPONSE**

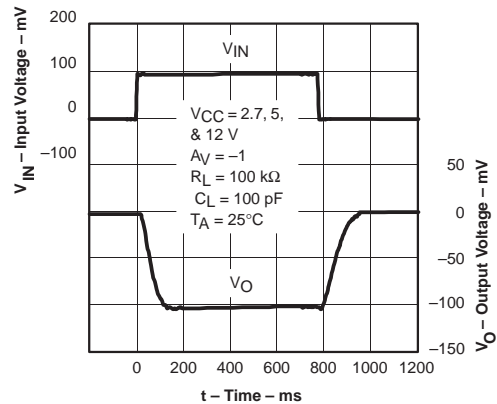

Figure 34

CROSTALK vs FREQUENCY

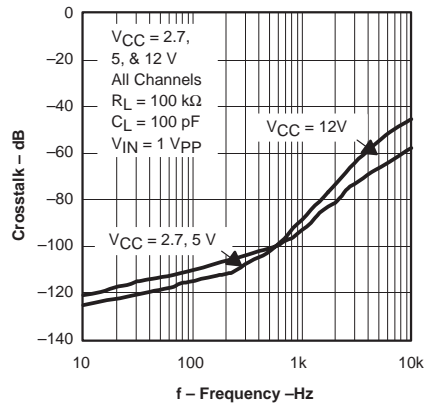
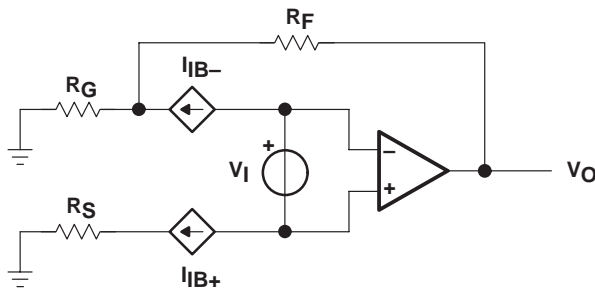

Figure 35

APPLICATION INFORMATION

offset voltage

The output offset voltage, (V_{OO}) is the sum of the input offset voltage (V_{IO}) and both input bias currents (I_{IB}) times the corresponding gains. The following schematic and formula can be used to calculate the output offset voltage:



$$V_{OO} = V_{IO} \left(1 + \left(\frac{R_F}{R_G} \right) \right) \pm I_{IB+} R_S \left(1 + \left(\frac{R_F}{R_G} \right) \right) \pm I_{IB-} R_F$$

Figure 36. Output Offset Voltage Model

general configurations

When receiving low-level signals, limiting the bandwidth of the incoming signals into the system is often required. The simplest way to accomplish this is to place an RC filter at the noninverting terminal of the amplifier (see Figure 37).

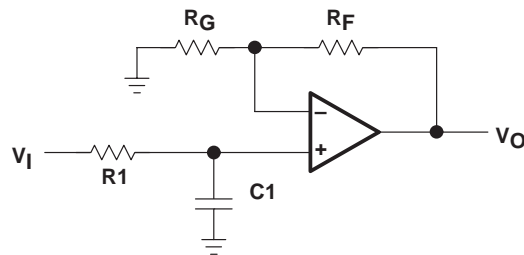

$$f_{-3dB} = \frac{1}{2\pi R1 C1}$$

$$\frac{V_O}{V_I} = \left(1 + \frac{R_F}{R_G} \right) \left(\frac{1}{1 + sR1C1} \right)$$

Figure 37. Single-Pole Low-Pass Filter

If even more attenuation is needed, a multiple pole filter is required. The Sallen-Key filter can be used for this task. For best results, the amplifier should have a bandwidth that is 8 to 10 times the filter frequency bandwidth. Failure to do this can result in phase shift of the amplifier.

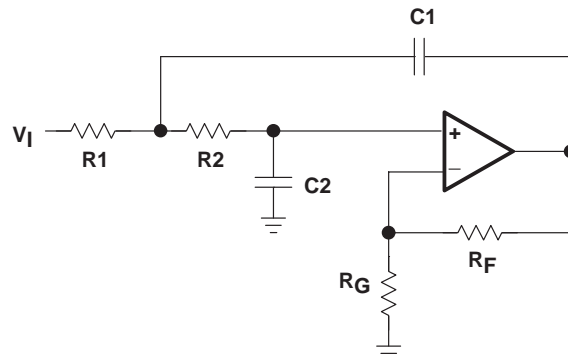

$R1 = R2 = R$
 $C1 = C2 = C$
 $Q = \text{Peaking Factor}$
 (Butterworth $Q = 0.707$)

$$f_{-3dB} = \frac{1}{2\pi RC}$$

$$R_G = \frac{R_F}{\left(2 - \frac{1}{Q} \right)}$$

Figure 38. 2-Pole Low-Pass Sallen-Key Filter

APPLICATION INFORMATION

circuit layout considerations

To achieve the levels of high performance of the TLV224x, follow proper printed-circuit board design techniques. A general set of guidelines is given in the following.

- Ground planes—It is highly recommended that a ground plane be used on the board to provide all components with a low inductive ground connection. However, in the areas of the amplifier inputs and output, the ground plane can be removed to minimize the stray capacitance.
- Proper power supply decoupling—Use a 6.8- μ F tantalum capacitor in parallel with a 0.1- μ F ceramic capacitor on each supply terminal. It may be possible to share the tantalum among several amplifiers depending on the application, but a 0.1- μ F ceramic capacitor should always be used on the supply terminal of every amplifier. In addition, the 0.1- μ F capacitor should be placed as close as possible to the supply terminal. As this distance increases, the inductance in the connecting trace makes the capacitor less effective. The designer should strive for distances of less than 0.1 inches between the device power terminals and the ceramic capacitors.
- Sockets—Sockets can be used but are not recommended. The additional lead inductance in the socket pins will often lead to stability problems. Surface-mount packages soldered directly to the printed-circuit board is the best implementation.
- Short trace runs/compact part placements—Optimum high performance is achieved when stray series inductance has been minimized. To realize this, the circuit layout should be made as compact as possible, thereby minimizing the length of all trace runs. Particular attention should be paid to the inverting input of the amplifier. Its length should be kept as short as possible. This will help to minimize stray capacitance at the input of the amplifier.
- Surface-mount passive components—Using surface-mount passive components is recommended for high performance amplifier circuits for several reasons. First, because of the extremely low lead inductance of surface-mount components, the problem with stray series inductance is greatly reduced. Second, the small size of surface-mount components naturally leads to a more compact layout thereby minimizing both stray inductance and capacitance. If leaded components are used, it is recommended that the lead lengths be kept as short as possible.

APPLICATION INFORMATION

general power dissipation considerations

For a given θ_{JA} , the maximum power dissipation is shown in Figure 39 and is calculated by the following formula:

$$P_D = \left(\frac{T_{MAX} - T_A}{\theta_{JA}} \right)$$

Where:

- P_D = Maximum power dissipation of THS224x IC (watts)
- T_{MAX} = Absolute maximum junction temperature (150°C)
- T_A = Free-ambient air temperature (°C)
- θ_{JA} = $\theta_{JC} + \theta_{CA}$
- θ_{JC} = Thermal coefficient from junction to case
- θ_{CA} = Thermal coefficient from case to ambient air (°C/W)

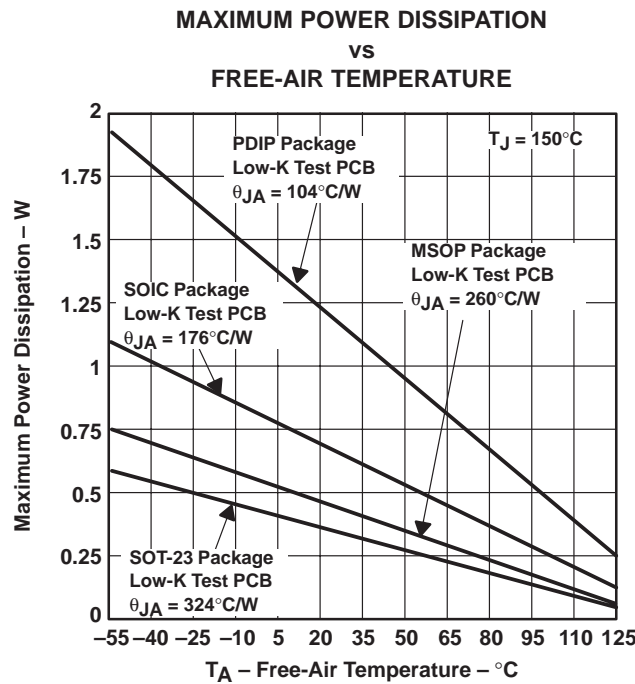

NOTE A: Results are with no air flow and using JEDEC Standard Low-K test PCB.

Figure 39. Maximum Power Dissipation vs Free-Air Temperature

TLV2241, TLV2242, TLV2244 FAMILY OF 1- μ A/Ch RAIL-TO-RAIL INPUT/OUTPUT OPERATIONAL AMPLIFIERS

SLOS329C – JULY 2000 REVISED - NOVEMBER 2000

APPLICATION INFORMATION

macromodel information

Macromodel information provided was derived using Microsim *Parts*™ Release 8, the model generation software used with Microsim *PSpice*™. The Boyle macromodel (see Note 2) and subcircuit in Figure 40 are generated using the TLV224x typical electrical and operating characteristics at $T_A = 25^\circ\text{C}$. Using this information, output simulations of the following key parameters can be generated to a tolerance of 20% (in most cases):

- Maximum positive output voltage swing
- Maximum negative output voltage swing
- Slew rate
- Quiescent power dissipation
- Input bias current
- Open-loop voltage amplification
- Unity-gain frequency
- Common-mode rejection ratio
- Phase margin
- DC output resistance
- AC output resistance
- Short-circuit output current limit

NOTE 2: G. R. Boyle, B. M. Cohn, D. O. Pederson, and J. E. Solomon, "Macromodeling of Integrated Circuit Operational Amplifiers", *IEEE Journal of Solid-State Circuits*, SC-9, 353 (1974).

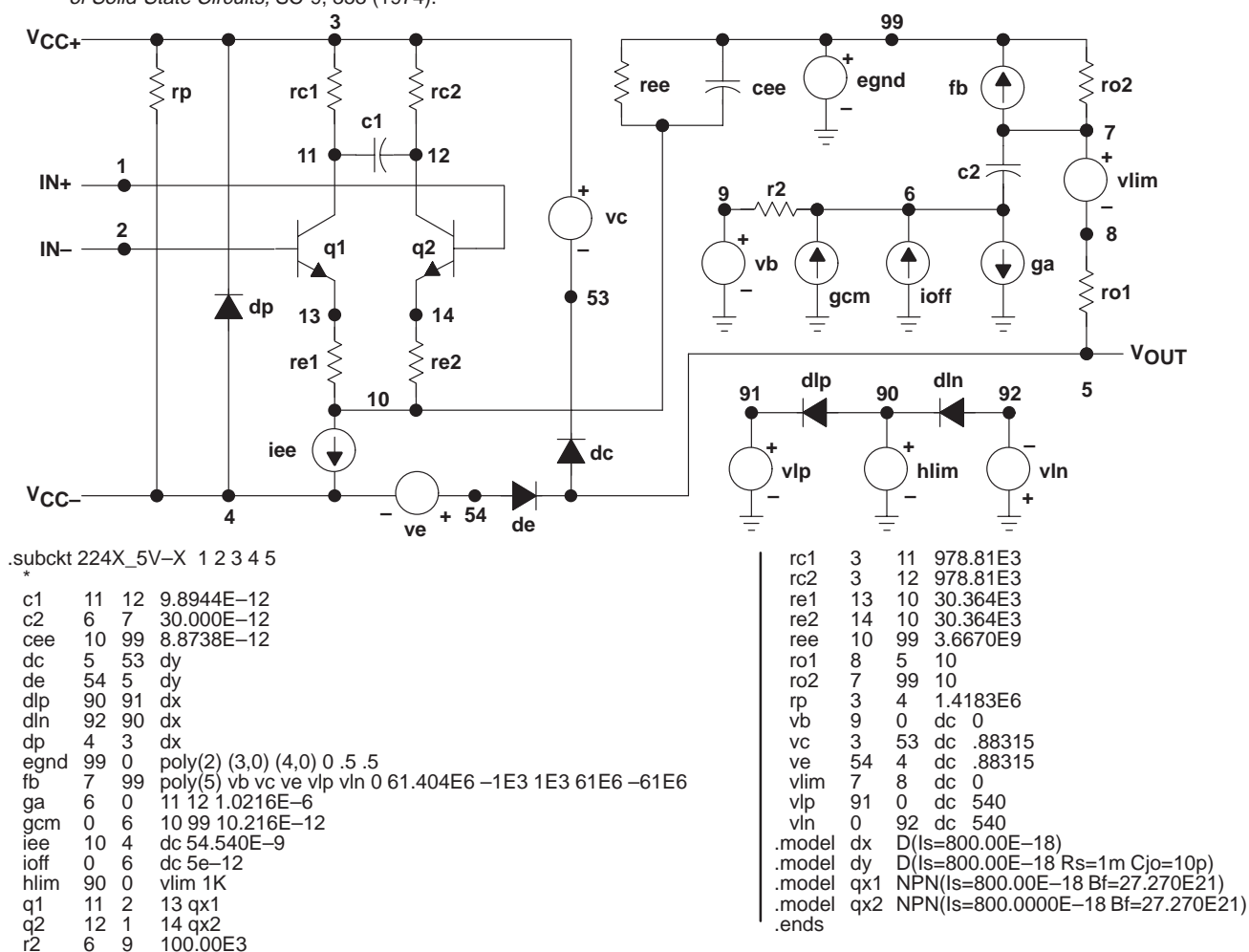

Figure 40. Boyle Macromodels and Subcircuit

PSpice and *Parts* are trademarks of MicroSim Corporation.



POST OFFICE BOX 655303 • DALLAS, TEXAS 75265

PACKAGING INFORMATION

| Orderable part number | Status (1) | Material type (2) | Package Pins | Package qty Carrier | RoHS (3) | Lead finish/ Ball material (4) | MSL rating/ Peak reflow (5) | Op temp (°C) | Part marking (6) |
|------------------------------|---------------|----------------------|------------------|-----------------------|-------------|--------------------------------------|-----------------------------------|--------------|---------------------|
| TLV2241ID | Obsolete | Production | SOIC (D) 8 | - | - | Call TI | Call TI | -40 to 125 | 2241I |
| TLV2241IDBVR | Active | Production | SOT-23 (DBV) 5 | 3000 LARGE T&R | Yes | NIPDAU SN | Level-1-260C-UNLIM | -40 to 125 | VBEI |
| TLV2241IDBVR.A | Active | Production | SOT-23 (DBV) 5 | 3000 LARGE T&R | Yes | SN | Level-1-260C-UNLIM | -40 to 125 | VBEI |
| TLV2241IDBVT | Active | Production | SOT-23 (DBV) 5 | 250 SMALL T&R | Yes | NIPDAU SN | Level-1-260C-UNLIM | -40 to 125 | VBEI |
| TLV2241IDBVT.A | Active | Production | SOT-23 (DBV) 5 | 250 SMALL T&R | Yes | NIPDAU | Level-1-260C-UNLIM | -40 to 125 | VBEI |
| TLV2241IDR | Active | Production | SOIC (D) 8 | 2500 LARGE T&R | Yes | NIPDAU | Level-1-260C-UNLIM | -40 to 125 | 2241I |
| TLV2241IDR.A | Active | Production | SOIC (D) 8 | 2500 LARGE T&R | Yes | NIPDAU | Level-1-260C-UNLIM | -40 to 125 | 2241I |
| TLV2241IP | Active | Production | PDIP (P) 8 | 50 TUBE | Yes | NIPDAU | N/A for Pkg Type | -40 to 125 | TLV2241I |
| TLV2241IP.A | Active | Production | PDIP (P) 8 | 50 TUBE | Yes | NIPDAU | N/A for Pkg Type | -40 to 125 | TLV2241I |
| TLV2242CD | Active | Production | SOIC (D) 8 | 75 TUBE | Yes | NIPDAU | Level-1-260C-UNLIM | 0 to 70 | 2242C |
| TLV2242CD.A | Active | Production | SOIC (D) 8 | 75 TUBE | Yes | NIPDAU | Level-1-260C-UNLIM | 0 to 70 | 2242C |
| TLV2242CDR | Active | Production | SOIC (D) 8 | 2500 LARGE T&R | Yes | NIPDAU | Level-1-260C-UNLIM | 0 to 70 | 2242C |
| TLV2242CDR.A | Active | Production | SOIC (D) 8 | 2500 LARGE T&R | Yes | NIPDAU | Level-1-260C-UNLIM | 0 to 70 | 2242C |
| TLV2242ID | Active | Production | SOIC (D) 8 | 75 TUBE | Yes | NIPDAU | Level-1-260C-UNLIM | -40 to 125 | 2242I |
| TLV2242ID.A | Active | Production | SOIC (D) 8 | 75 TUBE | Yes | NIPDAU | Level-1-260C-UNLIM | -40 to 125 | 2242I |
| TLV2242IDGK | Active | Production | VSSOP (DGK) 8 | 80 TUBE | Yes | NIPDAU | Level-1-260C-UNLIM | -40 to 125 | ALE |
| TLV2242IDGK.A | Active | Production | VSSOP (DGK) 8 | 80 TUBE | Yes | NIPDAU | Level-1-260C-UNLIM | -40 to 125 | ALE |
| TLV2242IDGKR | Active | Production | VSSOP (DGK) 8 | 2500 LARGE T&R | Yes | NIPDAU | Level-1-260C-UNLIM | -40 to 125 | ALE |
| TLV2242IDGKR.A | Active | Production | VSSOP (DGK) 8 | 2500 LARGE T&R | Yes | NIPDAU | Level-1-260C-UNLIM | -40 to 125 | ALE |
| TLV2242IDGKRG4 | Active | Production | VSSOP (DGK) 8 | 2500 LARGE T&R | - | Call TI | Call TI | -40 to 125 | |
| TLV2242IDR | Active | Production | SOIC (D) 8 | 2500 LARGE T&R | Yes | NIPDAU | Level-1-260C-UNLIM | -40 to 125 | 2242I |
| TLV2242IDR.A | Active | Production | SOIC (D) 8 | 2500 LARGE T&R | Yes | NIPDAU | Level-1-260C-UNLIM | -40 to 125 | 2242I |
| TLV2242IP | Active | Production | PDIP (P) 8 | 50 TUBE | Yes | NIPDAU | N/A for Pkg Type | -40 to 125 | TLV2242I |
| TLV2242IP.A | Active | Production | PDIP (P) 8 | 50 TUBE | Yes | NIPDAU | N/A for Pkg Type | -40 to 125 | TLV2242I |
| TLV2244ID | Active | Production | SOIC (D) 14 | 50 TUBE | Yes | NIPDAU | Level-1-260C-UNLIM | -40 to 125 | TLV2244I |
| TLV2244ID.A | Active | Production | SOIC (D) 14 | 50 TUBE | Yes | NIPDAU | Level-1-260C-UNLIM | -40 to 125 | TLV2244I |
| TLV2244IDR | Active | Production | SOIC (D) 14 | 2500 LARGE T&R | Yes | NIPDAU | Level-1-260C-UNLIM | -40 to 125 | TLV2244I |
| TLV2244IDR.A | Active | Production | SOIC (D) 14 | 2500 LARGE T&R | Yes | NIPDAU | Level-1-260C-UNLIM | -40 to 125 | TLV2244I |
| TLV2244IPW | Active | Production | TSSOP (PW) 14 | 90 TUBE | Yes | NIPDAU | Level-1-260C-UNLIM | -40 to 125 | 2244I |

| Orderable part number | Status (1) | Material type (2) | Package Pins | Package qty Carrier | RoHS (3) | Lead finish/ Ball material (4) | MSL rating/ Peak reflow (5) | Op temp (°C) | Part marking (6) |
|-----------------------------|---------------|----------------------|-----------------|-----------------------|-------------|--------------------------------------|-----------------------------------|--------------|---------------------|
| TLV2244IPW.A | Active | Production | TSSOP (PW) 14 | 90 TUBE | Yes | NIPDAU | Level-1-260C-UNLIM | -40 to 125 | 2244I |
| TLV2244IPWR | Active | Production | TSSOP (PW) 14 | 2000 LARGE T&R | Yes | NIPDAU | Level-1-260C-UNLIM | -40 to 125 | 2244I |
| TLV2244IPWR.A | Active | Production | TSSOP (PW) 14 | 2000 LARGE T&R | Yes | NIPDAU | Level-1-260C-UNLIM | -40 to 125 | 2244I |

(1) **Status:** For more details on status, see our [product life cycle](#).

(2) **Material type:** When designated, preproduction parts are prototypes/experimental devices, and are not yet approved or released for full production. Testing and final process, including without limitation quality assurance, reliability performance testing, and/or process qualification, may not yet be complete, and this item is subject to further changes or possible discontinuation. If available for ordering, purchases will be subject to an additional waiver at checkout, and are intended for early internal evaluation purposes only. These items are sold without warranties of any kind.

(3) **RoHS values:** Yes, No, RoHS Exempt. See the [TI RoHS Statement](#) for additional information and value definition.

(4) **Lead finish/Ball material:** Parts may have multiple material finish options. Finish options are separated by a vertical ruled line. Lead finish/Ball material values may wrap to two lines if the finish value exceeds the maximum column width.

(5) **MSL rating/Peak reflow:** The moisture sensitivity level ratings and peak solder (reflow) temperatures. In the event that a part has multiple moisture sensitivity ratings, only the lowest level per JEDEC standards is shown. Refer to the shipping label for the actual reflow temperature that will be used to mount the part to the printed circuit board.

(6) **Part marking:** There may be an additional marking, which relates to the logo, the lot trace code information, or the environmental category of the part.

Multiple part markings will be inside parentheses. Only one part marking contained in parentheses and separated by a "-" will appear on a part. If a line is indented then it is a continuation of the previous line and the two combined represent the entire part marking for that device.

Important Information and Disclaimer: The information provided on this page represents TI's knowledge and belief as of the date that it is provided. TI bases its knowledge and belief on information provided by third parties, and makes no representation or warranty as to the accuracy of such information. Efforts are underway to better integrate information from third parties. TI has taken and continues to take reasonable steps to provide representative and accurate information but may not have conducted destructive testing or chemical analysis on incoming materials and chemicals. TI and TI suppliers consider certain information to be proprietary, and thus CAS numbers and other limited information may not be available for release.

In no event shall TI's liability arising out of such information exceed the total purchase price of the TI part(s) at issue in this document sold by TI to Customer on an annual basis.

TAPE AND REEL INFORMATION

QUADRANT ASSIGNMENTS FOR PIN 1 ORIENTATION IN TAPE



*All dimensions are nominal

| Device | Package Type | Package Drawing | Pins | SPQ | Reel Diameter (mm) | Reel Width W1 (mm) | A0 (mm) | B0 (mm) | K0 (mm) | P1 (mm) | W (mm) | Pin1 Quadrant |
|--------------|--------------|-----------------|------|------|--------------------|--------------------|---------|---------|---------|---------|--------|---------------|
| TLV2241IDBVR | SOT-23 | DBV | 5 | 3000 | 178.0 | 8.4 | 3.2 | 3.2 | 1.4 | 4.0 | 8.0 | Q3 |
| TLV2241IDBVT | SOT-23 | DBV | 5 | 250 | 180.0 | 8.4 | 3.2 | 3.2 | 1.4 | 4.0 | 8.0 | Q3 |
| TLV2241IDR | SOIC | D | 8 | 2500 | 330.0 | 12.4 | 6.4 | 5.2 | 2.1 | 8.0 | 12.0 | Q1 |
| TLV2242CDR | SOIC | D | 8 | 2500 | 330.0 | 12.4 | 6.4 | 5.2 | 2.1 | 8.0 | 12.0 | Q1 |
| TLV2242IDGKR | VSSOP | DGK | 8 | 2500 | 330.0 | 12.4 | 5.3 | 3.4 | 1.4 | 8.0 | 12.0 | Q1 |
| TLV2242IDR | SOIC | D | 8 | 2500 | 330.0 | 12.4 | 6.4 | 5.2 | 2.1 | 8.0 | 12.0 | Q1 |
| TLV2244IDR | SOIC | D | 14 | 2500 | 330.0 | 16.4 | 6.5 | 9.0 | 2.1 | 8.0 | 16.0 | Q1 |
| TLV2244IPWR | TSSOP | PW | 14 | 2000 | 330.0 | 12.4 | 6.9 | 5.6 | 1.6 | 8.0 | 12.0 | Q1 |

TAPE AND REEL BOX DIMENSIONS

*All dimensions are nominal

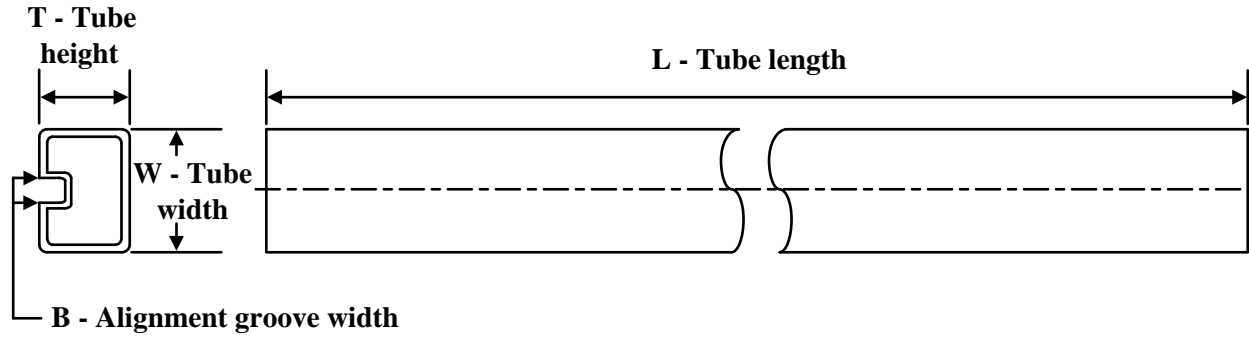
| Device | Package Type | Package Drawing | Pins | SPQ | Length (mm) | Width (mm) | Height (mm) |
|--------------|--------------|-----------------|------|------|-------------|------------|-------------|
| TLV2241IDBVR | SOT-23 | DBV | 5 | 3000 | 208.0 | 191.0 | 35.0 |
| TLV2241IDBVT | SOT-23 | DBV | 5 | 250 | 210.0 | 185.0 | 35.0 |
| TLV2241IDR | SOIC | D | 8 | 2500 | 353.0 | 353.0 | 32.0 |
| TLV2242CDR | SOIC | D | 8 | 2500 | 340.5 | 338.1 | 20.6 |
| TLV2242IDGKR | VSSOP | DGK | 8 | 2500 | 358.0 | 335.0 | 35.0 |
| TLV2242IDR | SOIC | D | 8 | 2500 | 353.0 | 353.0 | 32.0 |
| TLV2244IDR | SOIC | D | 14 | 2500 | 350.0 | 350.0 | 43.0 |
| TLV2244IPWR | TSSOP | PW | 14 | 2000 | 353.0 | 353.0 | 32.0 |

TUBE

*All dimensions are nominal

| Device | Package Name | Package Type | Pins | SPQ | L (mm) | W (mm) | T (μm) | B (mm) |
|--------------|--------------|--------------|------|-----|--------|--------|--------|--------|
| TLV2241IP | P | PDIP | 8 | 50 | 506 | 13.97 | 11230 | 4.32 |
| TLV2241IP.A | P | PDIP | 8 | 50 | 506 | 13.97 | 11230 | 4.32 |
| TLV2242CD | D | SOIC | 8 | 75 | 507 | 8 | 3940 | 4.32 |
| TLV2242CD | D | SOIC | 8 | 75 | 505.46 | 6.76 | 3810 | 4 |
| TLV2242CD.A | D | SOIC | 8 | 75 | 507 | 8 | 3940 | 4.32 |
| TLV2242CD.A | D | SOIC | 8 | 75 | 505.46 | 6.76 | 3810 | 4 |
| TLV2242ID | D | SOIC | 8 | 75 | 507 | 8 | 3940 | 4.32 |
| TLV2242ID | D | SOIC | 8 | 75 | 505.46 | 6.76 | 3810 | 4 |
| TLV2242ID.A | D | SOIC | 8 | 75 | 505.46 | 6.76 | 3810 | 4 |
| TLV2242ID.A | D | SOIC | 8 | 75 | 507 | 8 | 3940 | 4.32 |
| TLV2242IP | P | PDIP | 8 | 50 | 506 | 13.97 | 11230 | 4.32 |
| TLV2242IP.A | P | PDIP | 8 | 50 | 506 | 13.97 | 11230 | 4.32 |
| TLV2244ID | D | SOIC | 14 | 50 | 505.46 | 6.76 | 3810 | 4 |
| TLV2244ID.A | D | SOIC | 14 | 50 | 505.46 | 6.76 | 3810 | 4 |
| TLV2244IPW | PW | TSSOP | 14 | 90 | 530 | 10.2 | 3600 | 3.5 |
| TLV2244IPW.A | PW | TSSOP | 14 | 90 | 530 | 10.2 | 3600 | 3.5 |



D0008A

PACKAGE OUTLINE

SOIC - 1.75 mm max height

SMALL OUTLINE INTEGRATED CIRCUIT



4214825/C 02/2019

NOTES:

1. Linear dimensions are in inches [millimeters]. Dimensions in parenthesis are for reference only. Controlling dimensions are in inches. Dimensioning and tolerancing per ASME Y14.5M.
2. This drawing is subject to change without notice.
3. This dimension does not include mold flash, protrusions, or gate burrs. Mold flash, protrusions, or gate burrs shall not exceed .006 [0.15] per side.
4. This dimension does not include interlead flash.
5. Reference JEDEC registration MS-012, variation AA.

EXAMPLE BOARD LAYOUT

D0008A

SOIC - 1.75 mm max height

SMALL OUTLINE INTEGRATED CIRCUIT



LAND PATTERN EXAMPLE
EXPOSED METAL SHOWN
SCALE:8X



SOLDER MASK DETAILS

4214825/C 02/2019

NOTES: (continued)

6. Publication IPC-7351 may have alternate designs.

7. Solder mask tolerances between and around signal pads can vary based on board fabrication site.

EXAMPLE STENCIL DESIGN

D0008A

SOIC - 1.75 mm max height

SMALL OUTLINE INTEGRATED CIRCUIT



SOLDER PASTE EXAMPLE
BASED ON .005 INCH [0.125 MM] THICK STENCIL
SCALE:8X

4214825/C 02/2019

NOTES: (continued)

8. Laser cutting apertures with trapezoidal walls and rounded corners may offer better paste release. IPC-7525 may have alternate design recommendations.
9. Board assembly site may have different recommendations for stencil design.

P (R-PDIP-T8)

PLASTIC DUAL-IN-LINE PACKAGE

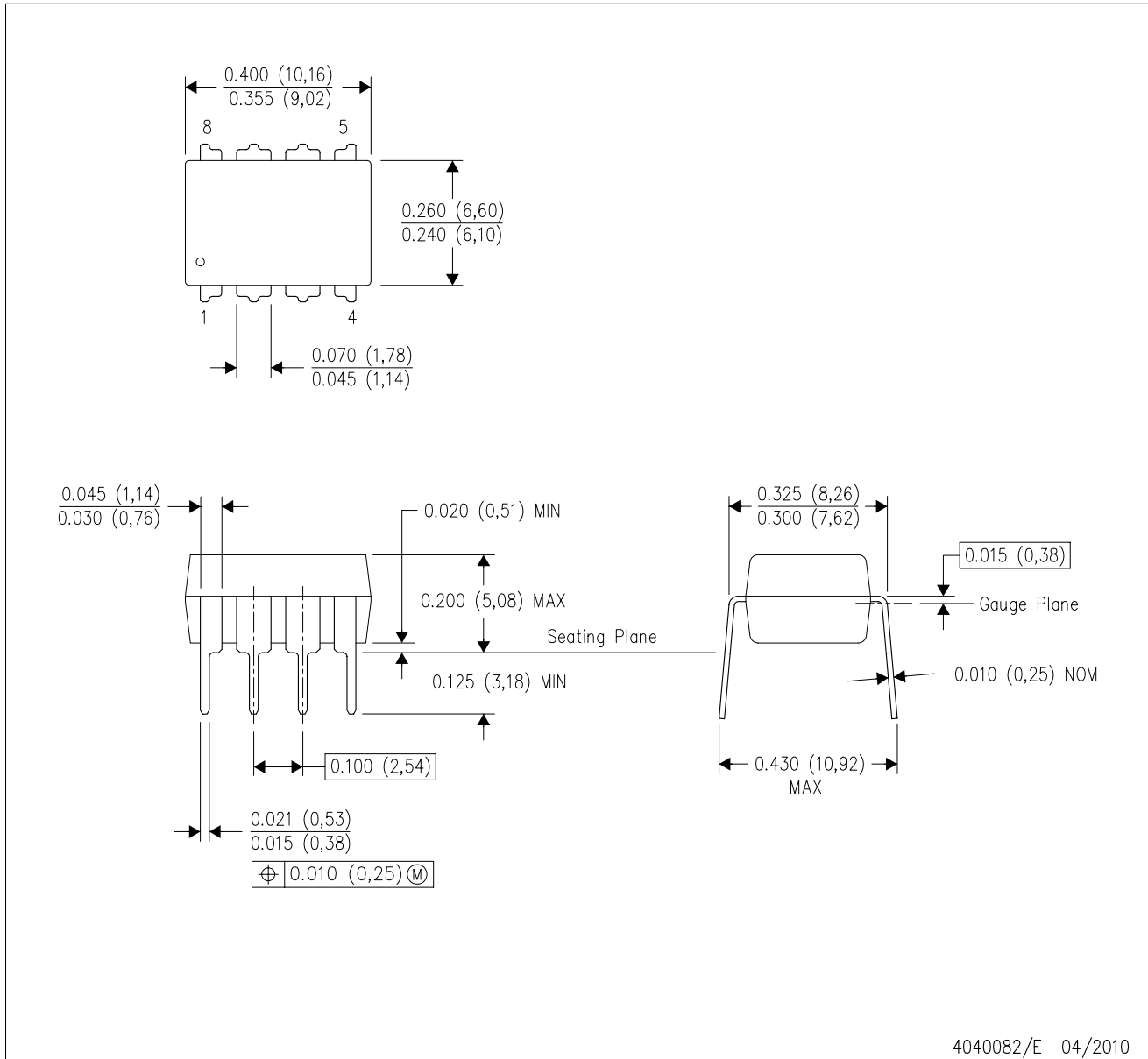

- NOTES:
- A. All linear dimensions are in inches (millimeters).
 - B. This drawing is subject to change without notice.
 - C. Falls within JEDEC MS-001 variation BA.

PW0014A



PACKAGE OUTLINE

TSSOP - 1.2 mm max height

SMALL OUTLINE PACKAGE

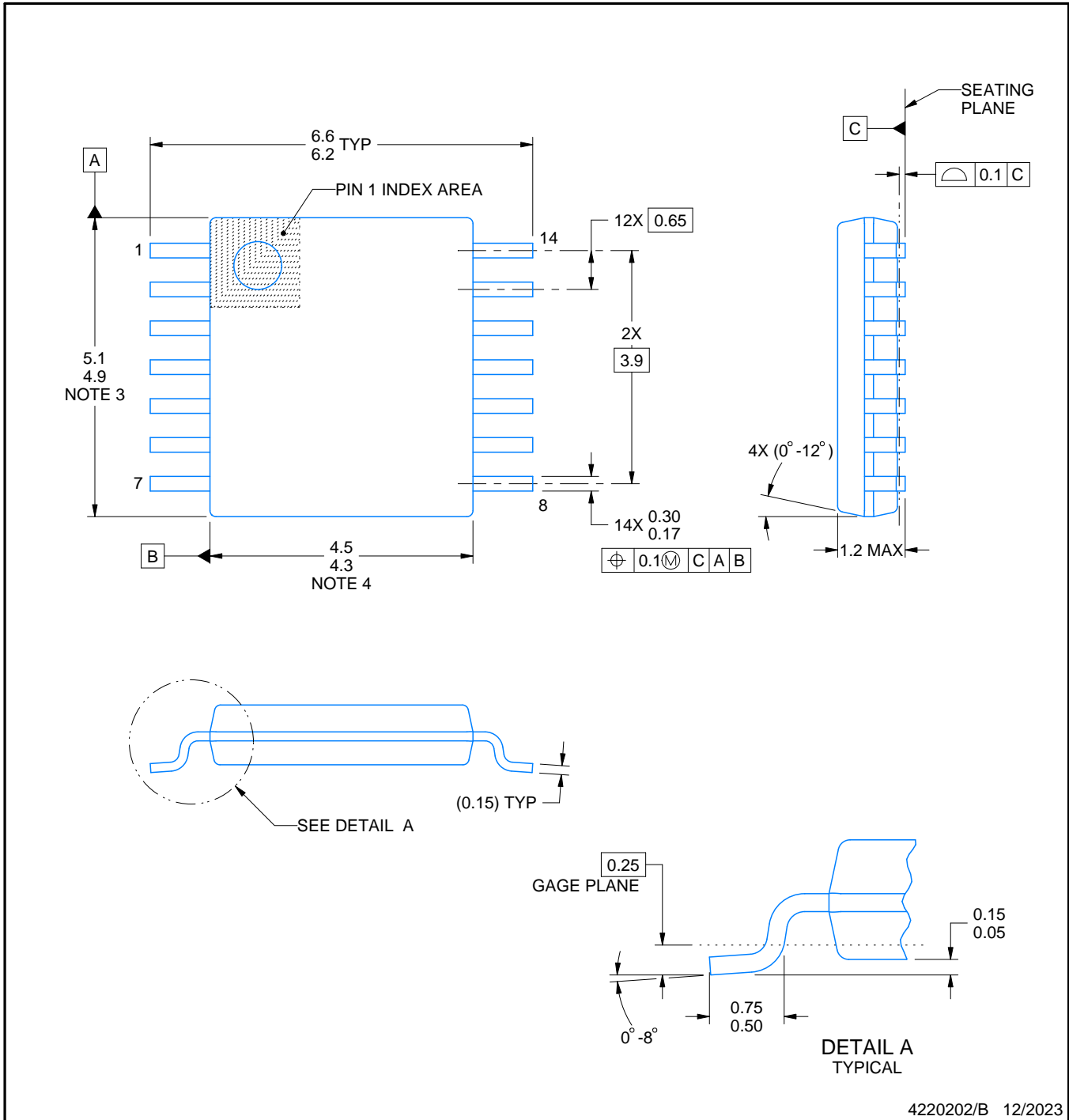

4220202/B 12/2023

NOTES:

1. All linear dimensions are in millimeters. Any dimensions in parenthesis are for reference only. Dimensioning and tolerancing per ASME Y14.5M.
2. This drawing is subject to change without notice.
3. This dimension does not include mold flash, protrusions, or gate burrs. Mold flash, protrusions, or gate burrs shall not exceed 0.15 mm per side.
4. This dimension does not include interlead flash. Interlead flash shall not exceed 0.25 mm per side.
5. Reference JEDEC registration MO-153.

EXAMPLE BOARD LAYOUT

PW0014A

TSSOP - 1.2 mm max height

SMALL OUTLINE PACKAGE

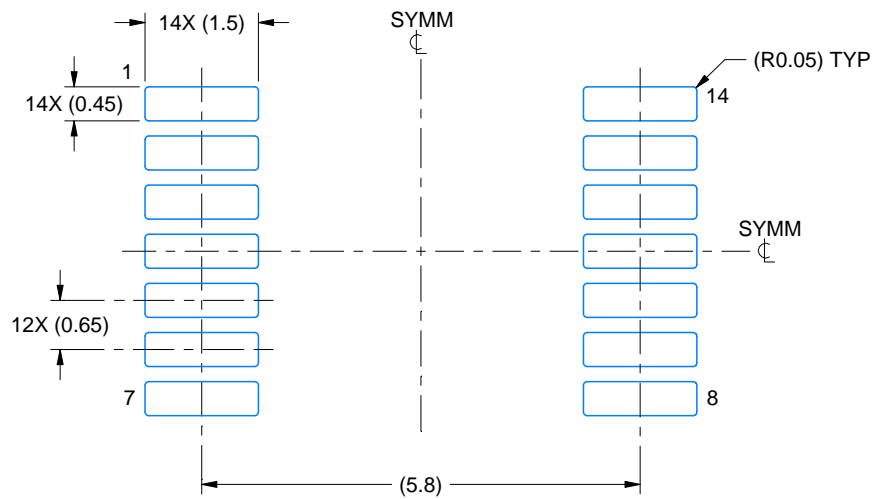

LAND PATTERN EXAMPLE
EXPOSED METAL SHOWN
SCALE: 10X

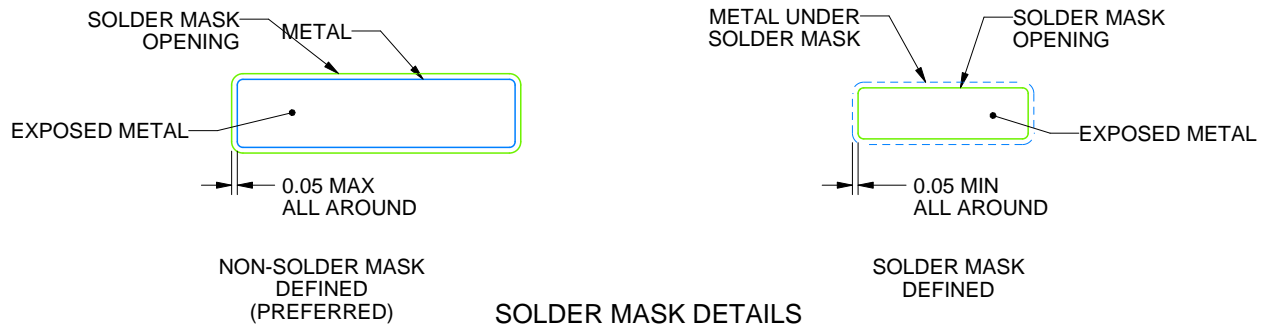

4220202/B 12/2023

NOTES: (continued)

- 6. Publication IPC-7351 may have alternate designs.
- 7. Solder mask tolerances between and around signal pads can vary based on board fabrication site.

EXAMPLE STENCIL DESIGN

PW0014A

TSSOP - 1.2 mm max height

SMALL OUTLINE PACKAGE

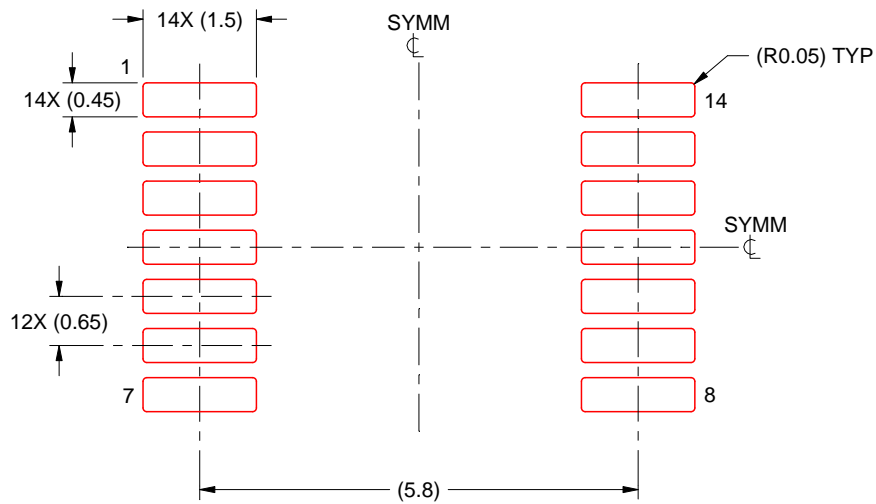

SOLDER PASTE EXAMPLE
BASED ON 0.125 mm THICK STENCIL
SCALE: 10X

4220202/B 12/2023

NOTES: (continued)

8. Laser cutting apertures with trapezoidal walls and rounded corners may offer better paste release. IPC-7525 may have alternate design recommendations.
9. Board assembly site may have different recommendations for stencil design.

EXAMPLE BOARD LAYOUT

DBV0005A

SOT-23 - 1.45 mm max height

SMALL OUTLINE TRANSISTOR



LAND PATTERN EXAMPLE
EXPOSED METAL SHOWN
SCALE:15X

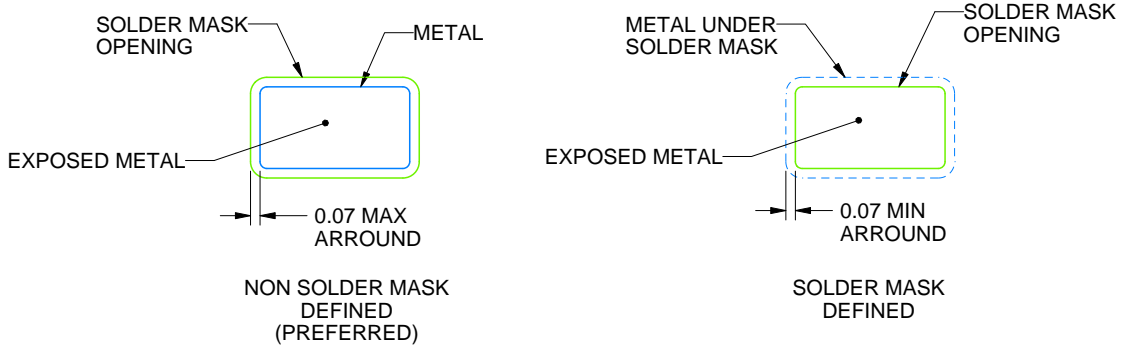

SOLDER MASK DETAILS

4214839/K 08/2024

NOTES: (continued)

- 6. Publication IPC-7351 may have alternate designs.
- 7. Solder mask tolerances between and around signal pads can vary based on board fabrication site.

EXAMPLE STENCIL DESIGN

DBV0005A

SOT-23 - 1.45 mm max height

SMALL OUTLINE TRANSISTOR



SOLDER PASTE EXAMPLE
BASED ON 0.125 mm THICK STENCIL
SCALE:15X

4214839/K 08/2024

NOTES: (continued)

8. Laser cutting apertures with trapezoidal walls and rounded corners may offer better paste release. IPC-7525 may have alternate design recommendations.
9. Board assembly site may have different recommendations for stencil design.

EXAMPLE BOARD LAYOUT

DGK0008A

™ VSSOP - 1.1 mm max height

SMALL OUTLINE PACKAGE



LAND PATTERN EXAMPLE
EXPOSED METAL SHOWN
SCALE: 15X



SOLDER MASK DETAILS

4214862/A 04/2023

NOTES: (continued)

6. Publication IPC-7351 may have alternate designs.
7. Solder mask tolerances between and around signal pads can vary based on board fabrication site.
8. Vias are optional depending on application, refer to device data sheet. If any vias are implemented, refer to their locations shown on this view. It is recommended that vias under paste be filled, plugged or tented.
9. Size of metal pad may vary due to creepage requirement.

EXAMPLE STENCIL DESIGN

DGK0008A

TM VSSOP - 1.1 mm max height

SMALL OUTLINE PACKAGE



SOLDER PASTE EXAMPLE
SCALE: 15X

4214862/A 04/2023

NOTES: (continued)

11. Laser cutting apertures with trapezoidal walls and rounded corners may offer better paste release. IPC-7525 may have alternate design recommendations.
12. Board assembly site may have different recommendations for stencil design.

D0014A

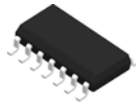

PACKAGE OUTLINE

SOIC - 1.75 mm max height

SMALL OUTLINE INTEGRATED CIRCUIT



NOTES:

1. All linear dimensions are in millimeters. Dimensions in parenthesis are for reference only. Dimensioning and tolerancing per ASME Y14.5M.
2. This drawing is subject to change without notice.
3. This dimension does not include mold flash, protrusions, or gate burrs. Mold flash, protrusions, or gate burrs shall not exceed 0.15 mm, per side.
4. This dimension does not include interlead flash. Interlead flash shall not exceed 0.43 mm, per side.
5. Reference JEDEC registration MS-012, variation AB.

EXAMPLE BOARD LAYOUT

D0014A

SOIC - 1.75 mm max height

SMALL OUTLINE INTEGRATED CIRCUIT



LAND PATTERN EXAMPLE
SCALE:8X



SOLDER MASK DETAILS

4220718/A 09/2016

NOTES: (continued)

- 6. Publication IPC-7351 may have alternate designs.
- 7. Solder mask tolerances between and around signal pads can vary based on board fabrication site.

EXAMPLE STENCIL DESIGN

D0014A

SOIC - 1.75 mm max height

SMALL OUTLINE INTEGRATED CIRCUIT



SOLDER PASTE EXAMPLE
BASED ON 0.125 mm THICK STENCIL
SCALE:8X

4220718/A 09/2016

NOTES: (continued)

8. Laser cutting apertures with trapezoidal walls and rounded corners may offer better paste release. IPC-7525 may have alternate design recommendations.
9. Board assembly site may have different recommendations for stencil design.

IMPORTANT NOTICE AND DISCLAIMER

TI PROVIDES TECHNICAL AND RELIABILITY DATA (INCLUDING DATASHEETS), DESIGN RESOURCES (INCLUDING REFERENCE DESIGNS), APPLICATION OR OTHER DESIGN ADVICE, WEB TOOLS, SAFETY INFORMATION, AND OTHER RESOURCES "AS IS" AND WITH ALL FAULTS, AND DISCLAIMS ALL WARRANTIES, EXPRESS AND IMPLIED, INCLUDING WITHOUT LIMITATION ANY IMPLIED WARRANTIES OF MERCHANTABILITY, FITNESS FOR A PARTICULAR PURPOSE OR NON-INFRINGEMENT OF THIRD PARTY INTELLECTUAL PROPERTY RIGHTS.

These resources are intended for skilled developers designing with TI products. You are solely responsible for (1) selecting the appropriate TI products for your application, (2) designing, validating and testing your application, and (3) ensuring your application meets applicable standards, and any other safety, security, regulatory or other requirements.

These resources are subject to change without notice. TI grants you permission to use these resources only for development of an application that uses the TI products described in the resource. Other reproduction and display of these resources is prohibited. No license is granted to any other TI intellectual property right or to any third party intellectual property right. TI disclaims responsibility for, and you fully indemnify TI and its representatives against any claims, damages, costs, losses, and liabilities arising out of your use of these resources.

TI's products are provided subject to [TI's Terms of Sale](#), [TI's General Quality Guidelines](#), or other applicable terms available either on ti.com or provided in conjunction with such TI products. TI's provision of these resources does not expand or otherwise alter TI's applicable warranties or warranty disclaimers for TI products. Unless TI explicitly designates a product as custom or customer-specified, TI products are standard, catalog, general purpose devices.

TI objects to and rejects any additional or different terms you may propose.

Copyright © 2026, Texas Instruments Incorporated

Last updated 10/2025