

TMAG5134 High Sensitivity, In-Plane Hall-Effect Switch With Concentrator

1 Features

- Supply range: 1.65V to 5.5V
- Operating temperature range: –40°C to 125°C
- In-plane axis of sensitivity
- Integrated magnetic concentrator
- Magnetic pole detection options:
 - Omnipolar
 - Dual-unipolar
- Output type:
 - Push-pull
 - Open-drain
- Available in both active low and active high
- Magnetic operate points (B_{OP})
 - 0.9mT
 - 1.0mT
 - 1.3mT
 - 1.5mT
 - 2mT
- Low average current consumption I_{CCAVG}
 - 1.25Hz: 0.5 μ A
 - 5Hz: 0.6 μ A
 - 10Hz: 0.9 μ A
 - 20Hz: 1.4 μ A
- Industry standard package and pinout
 - SOT-23 (DBV)
 - X1LGA (ZFC)

2 Applications

- [Door and window sensor](#)
- [Appliances](#)
- [Water meters](#)
- [Gas meters](#)
- [E-locks](#)
- [Medical devices](#)
- [Tablets](#)
- [Laptops](#)
- [Internet of Things \(IoT\)](#)

3 Description

The TMAG5134 is a high sensitivity, low power, in-plane hall effect digital switch designed to replace TMR, AMR and Reed switches. The TMAG5134 features an integrated magnetic concentrator to achieve higher sensitivity and lower power consumption than traditional hall effect devices.

The TMAG5134 product family is available in packages with either a single omni-polar output (SOT-23) or with two independent unipolar outputs (X1LGA). The device supports multiple combinations of high sensitivity thresholds with various sampling rates that allow flexible system design for magnet selection, sensitivity, and power requirements.

To minimize power consumption, the TMAG5134 is internally duty-cycled. The device has a push-pull (CMOS) output which eliminates the need for an external pullup resistor, and is available in industry standard SOT-23 and X1LGA packages. The TMAG5134 is also available in an open-drain configuration.

Package Information

| PART NUMBER | PACKAGE ⁽¹⁾ | PACKAGE SIZE ⁽²⁾ |
|-------------|------------------------|-----------------------------|
| TMAG5134 | DBV (SOT-23, 3) | 2.92mm × 2.8mm |
| | ZFC (X1LGA, 4) | 0.90mm × 1.30mm |

(1) For more information, see [Section 11](#).

(2) The package size (length × width) is a nominal value and includes pins, where applicable.

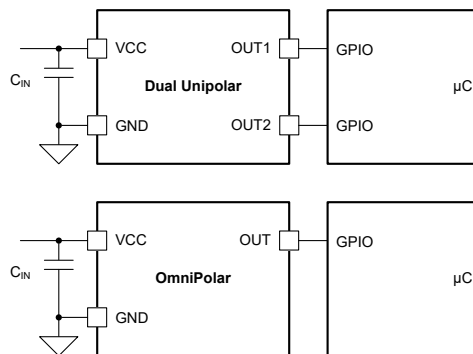

TMAG5134 Simplified Schematic



Table of Contents

| | | | |
|--|----|--|----|
| 1 Features | 1 | 7.4 Device Functional Modes..... | 15 |
| 2 Applications | 1 | 8 Application and Implementation | 16 |
| 3 Description | 1 | 8.1 Application Information..... | 16 |
| 4 Device Comparison Table | 3 | 8.2 Typical Application..... | 16 |
| 5 Pin Configuration and Functions | 4 | 8.3 Power Supply Recommendations..... | 17 |
| 6 Specifications | 5 | 8.4 Layout..... | 17 |
| 6.1 Absolute Maximum Ratings..... | 5 | 9 Device and Documentation Support | 19 |
| 6.2 ESD Ratings..... | 5 | 9.1 Documentation Support..... | 19 |
| 6.3 Recommended Operating Conditions..... | 5 | 9.2 Receiving Notification of Documentation Updates.... | 19 |
| 6.4 Thermal Information..... | 5 | 9.3 Support Resources..... | 19 |
| 6.5 Electrical Characteristics..... | 6 | 9.4 Trademarks..... | 19 |
| 6.6 Magnetic Characteristics..... | 7 | 9.5 Electrostatic Discharge Caution..... | 19 |
| 6.7 Typical Characteristics..... | 8 | 9.6 Glossary..... | 19 |
| 7 Detailed Description | 10 | 10 Revision History | 19 |
| 7.1 Overview..... | 10 | 11 Mechanical, Packaging, and Orderable Information | 20 |
| 7.2 Functional Block Diagram..... | 10 | | |
| 7.3 Feature Description..... | 11 | | |

4 Device Comparison Table

| PART NUMBER | TYPICAL B _{OP} THRESHOLD | TYPICAL HYSTERESIS | MAGNETIC RESPONSE | OUTPUT TYPE | SAMPLING RATE | PACKAGES AVAILABLE |
|-----------------|-----------------------------------|--------------------|---------------------------|-------------|---------------|--------------------|
| TMAG5134A1CDBVR | 1mT | 0.4mT | Omnipolar, Active Low | Push-pull | 10Hz | SOT-23 |
| TMAG5134B1ADBVR | 1.3mT | 0.4mT | Omnipolar, Active Low | Push-pull | 1.25Hz | SOT-23 |
| TMAG5134B1BDBVR | 1.3mT | 0.4mT | Omnipolar, Active Low | Push-pull | 5Hz | SOT-23 |
| TMAG5134B1DDBVR | 1.3mT | 0.4mT | Omnipolar, Active Low | Push-pull | 20Hz | SOT-23 |
| TMAG5134B5DZFCR | 1.3mT | 0.4mT | Dual-unipolar, Active Low | Push-pull | 20Hz | X1LGA |
| TMAG5134C1ADBVR | 1.5mT | 0.4mT | Omnipolar, Active Low | Push-pull | 1.25Hz | SOT-23 |
| TMAG5134C1CDBVR | 1.5mT | 0.4mT | Omnipolar, Active Low | Push-pull | 10Hz | SOT-23 |
| TMAG5134E1DDBVR | 2mT | 0.4mT | Omnipolar, Active Low | Push-pull | 20Hz | SOT-23 |
| TMAG5134E4CZFCR | 2mT | 0.4mT | Dual-unipolar, Active Low | Open-Drain | 10Hz | X1LGA |
| TMAG5134H1CDBVR | 0.9mT | 0.4mT | Omnipolar, Active Low | Push-pull | 10Hz | SOT-23 |

Table 4-1 indicates the B_{OP}, output configuration, and sampling rate options available for the TMAG5134xxx. For example, TMAG5143C6G is a 1.5mT BOP, Unipolar, Active High, Open Drain, 160Hz version of the device. For new version samples please contact your local representative. Additional sampling rates up to 20kHz available.

Table 4-1. Additional Device Configuration Options

| B _{OP} | Output Configuration | Sampling Rate |
|------------------|---|-------------------|
| A = 1.0mT | 0 - Omnipolar, Active Low, Open-Drain | A = 1.25Hz |
| B = 1.3mT | 1 - Omnipolar, Active Low, Push-pull | B = 5Hz |
| C = 1.5mT | 2 - Omnipolar, Active High, Open-Drain | C = 10Hz |
| D = 1.8mT | 3 - Omnipolar, Active High, Push-pull | D = 20Hz |
| E = 2.0mT | 4 - Unipolar, Active Low, Open-Drain | E = 40Hz |
| F = 2.5mT | 5 - Unipolar, Active Low, Push-pull | F = 80Hz |
| G = 3.0mT | 6 - Unipolar, Active High, Open-Drain | G = 160Hz |
| H = 0.9mT | 7 - Unipolar, Active High, Push-pull | H = 320Hz |
| | | I = 640Hz |
| | | J = 8kHz |
| | | K = 1kHz |
| | | L = 2.5kHz |
| | | M = 5kHz |
| | | N = 10kHz |
| | | O = 20kHz |

5 Pin Configuration and Functions

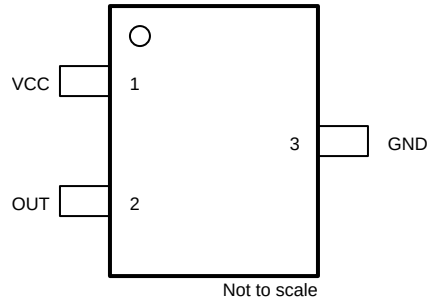

Figure 5-1. DBV Package, 3-Pin SOT-23 (Top View)

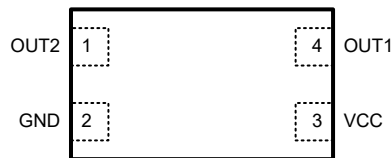

Figure 5-2. ZFC Package, 4-Pin X1LGA (Top View)

Table 5-1. Pin Functions

| NAME | PIN | | TYPE ⁽¹⁾ | DESCRIPTION |
|------|------------|-----------|---------------------|---|
| | SOT-23 (3) | X1LGA (4) | | |
| GND | 3 | 2 | G | Ground |
| OUT | 2 | - | O | Omnipolar output, responds to both positive and negative magnetic flux density through the package. |
| OUT1 | - | 4 | O | Unipolar output, responds to positive magnetic flux density through the package. |
| OUT2 | - | 1 | O | Unipolar output, responds to negative magnetic flux density through the package. |
| VCC | 1 | 3 | P | Supply voltage |

(1) G = ground, O = output, I = input

6 Specifications

6.1 Absolute Maximum Ratings

over operating free-air temperature range (unless otherwise noted)⁽¹⁾

| | | MIN | MAX | UNIT |
|----------------------------------|-----------------|-----------|----------------|------|
| Power supply voltage | V_{CC} | -0.3 | 6 | V |
| Output pin voltage | OUT, OUT1, OUT2 | GND - 0.3 | $V_{CC} + 0.3$ | |
| Output pin current | OUT, OUT1, OUT2 | -5.5 | 5.5 | mA |
| Magnetic flux density, B_{MAX} | | Unlimited | | T |
| Junction temperature, T_J | | -65 | 150 | °C |
| Storage temperature, T_{stg} | | -65 | 150 | °C |

- (1) Operation outside the Absolute Maximum Ratings may cause permanent device damage. Absolute Maximum Ratings do not imply functional operation of the device at these or any other conditions beyond those listed under Recommended Operating Conditions. If used outside the Recommended Operating Conditions but within the Absolute Maximum Ratings, the device may not be fully functional, and this may affect device reliability, functionality, performance, and shorten the device lifetime.

6.2 ESD Ratings

| | | | VALUE | UNIT |
|-------------|-------------------------|---|-------|------|
| $V_{(ESD)}$ | Electrostatic discharge | Human body model (HBM), per ANSI/ESDA/JEDEC JS-001, all pins ⁽¹⁾ | ±2000 | V |
| | | Charged device model (CDM), ANSI/ESDA/JEDEC JS-002 ⁽²⁾ | ±500 | |

- (1) JEDEC document JEP155 states that 500V HBM allows safe manufacturing with a standard ESD control process.
 (2) JEDEC document JEP157 states that 250V CDM allows safe manufacturing with a standard ESD control process.

6.3 Recommended Operating Conditions

over operating free-air temperature range (unless otherwise noted)

| | | MIN | MAX | UNIT |
|----------|---------------------------------|------|----------|------|
| V_{CC} | Power supply voltage | 1.65 | 5.5 | V |
| V_O | Output voltage, OUT, OUT1, OUT2 | 0 | V_{CC} | V |
| I_O | Output current, OUT, OUT1, OUT2 | -5 | 5 | mA |
| T_A | Ambient temperature | -40 | 125 | °C |

6.4 Thermal Information

| THERMAL METRIC ⁽¹⁾ | | TMAG5134 | | UNIT |
|-------------------------------|--|--------------|-------------|------|
| | | SOT-23 (DBV) | X1LGA (ZFC) | |
| | | 3 PINS | 4 PINS | |
| $R_{\theta JA}$ | Junction-to-ambient thermal resistance | 233.8 | 393.5 | °C/W |
| $R_{\theta JC(top)}$ | Junction-to-case (top) thermal resistance | 89.1 | 149.7 | |
| $R_{\theta JB}$ | Junction-to-board thermal resistance | 76.2 | 257.8 | |
| Ψ_{JT} | Junction-to-top characterization parameter | 33.1 | 7.1 | |
| Ψ_{JB} | Junction-to-board characterization parameter | 75.3 | 273.2 | |

- (1) For more information about traditional and new thermal metrics, see the [Semiconductor and IC Package Thermal Metrics](#) application note.

6.5 Electrical Characteristics

over free-air temperature range and $V_{CC} = 1.65V$ to $5.5V$ (unless otherwise noted); Typical specifications are at $T_A = 25^\circ C$ and $V_{CC} = 3.3V$ (unless otherwise noted)

| PARAMETER | | TEST CONDITIONS | MIN | TYP | MAX | UNIT |
|-----------------------------|-----------------------------------|--------------------------------------|-----------------|------|----------|---------|
| DIGITAL INPUT/OUTPUT | | | | | | |
| V_{OH} | High-level output voltage | $I_O = -0.5mA$ | $V_{CC} - 0.05$ | | V_{CC} | V |
| | | $I_O = -5mA$ | $V_{CC} - 0.70$ | | V_{CC} | |
| V_{OL} | Low-level output voltage | $I_O = 0.5mA$ | 0 | | 0.03 | V |
| | | $I_O = 5mA$ | 0 | | 0.40 | |
| POWER SUPPLY | | | | | | |
| I_{ACTIVE} | Supply current during measurement | $T_A = 25^\circ C$ | | 2.4 | 3.0 | mA |
| | | $T_A = -40^\circ C$ to $85^\circ C$ | | | 3.3 | |
| | | $T_A = -40^\circ C$ to $125^\circ C$ | | | 3.5 | |
| I_{SLEEP} | Sleep current | $T_A = 25^\circ C$ | | 0.32 | 0.55 | μA |
| | | $T_A = -40^\circ C$ to $85^\circ C$ | | | 0.75 | |
| | | $T_A = -40^\circ C$ to $125^\circ C$ | | | 1.3 | |
| t_{ON} | Power-on time | $V_{CC} = 5.5V$ | | 60 | 500 | μs |
| t_{ACTIVE} | Active time period | | | 26 | | μs |
| C_{OUT} | Pin capacitance | $f = 1MHz$ | | 2 | | pF |
| TMAG5134xxA 1.25Hz | | | | | | |
| f_S | Frequency of magnetic sampling | | 0.45 | 1.25 | 2.15 | Hz |
| t_S | Period of magnetic sampling | | 465 | 800 | 2222 | ms |
| $I_{CCA\text{VG}}$ | Average current consumption | $T_A = 25^\circ C$ | | 0.39 | 0.59 | μA |
| | | $T_A = -40^\circ C$ to $85^\circ C$ | | | 0.81 | |
| | | $T_A = -40^\circ C$ to $125^\circ C$ | | | 1.3 | |
| TMAG5134xxB 5Hz | | | | | | |
| f_S | Frequency of magnetic sampling | | 1.8 | 5 | 8.2 | Hz |
| t_S | Period of magnetic sampling | | 121 | 200 | 555 | ms |
| $I_{CCA\text{VG}}$ | Average current consumption | $T_A = 25^\circ C$ | | 0.6 | 0.95 | μA |
| | | $T_A = -40^\circ C$ to $85^\circ C$ | | | 1.15 | |
| | | $T_A = -40^\circ C$ to $125^\circ C$ | | | 1.65 | |
| TMAG5134xxC 10Hz | | | | | | |
| f_S | Frequency of magnetic sampling | | 4 | 10 | 18 | Hz |
| t_S | Period of magnetic sampling | | 55 | 100 | 250 | ms |
| $I_{CCA\text{VG}}$ | Average current consumption | $T_A = 25^\circ C$ | | 0.9 | 1.42 | μA |
| | | $T_A = -40^\circ C$ to $85^\circ C$ | | | 1.62 | |
| | | $T_A = -40^\circ C$ to $125^\circ C$ | | | 2.19 | |
| TMAG5134xxD 20Hz | | | | | | |
| f_S | Frequency of magnetic sampling | | 7.5 | 20 | 35 | Hz |
| t_S | Period of magnetic sampling | | 28 | 50 | 133 | ms |
| $I_{CCA\text{VG}}$ | Average current consumption | $T_A = 25^\circ C$ | | 1.4 | 2.1 | μA |
| | | $T_A = -40^\circ C$ to $85^\circ C$ | | | 2.5 | |
| | | $T_A = -40^\circ C$ to $125^\circ C$ | | | 3.0 | |

6.6 Magnetic Characteristics

over free-air temperature range and $V_{CC} = 1.65V$ to $5.5V$ (unless otherwise noted); Typical specifications are at $T_A = 25^\circ C$ and $V_{CC} = 3.3V$ (unless otherwise noted)

| PARAMETER | | TEST CONDITIONS | MIN | TYP | MAX | UNIT |
|--------------------------|---|---------------------------------|-------|------|-------|------|
| TMAG5134Axx 1mT | | | | | | |
| B _{OP} | Magnetic threshold operate point | T _A = 25°C | ±0.75 | ±1 | ±1.25 | mT |
| | | T _A = -40°C to 85°C | ±0.7 | ±1 | ±1.3 | |
| | | T _A = -40°C to 125°C | ±0.7 | ±1 | ±1.3 | |
| B _{RP} | Magnetic release operate point | T _A = 25°C | ±0.33 | ±0.6 | ±0.87 | mT |
| | | T _A = -40°C to 85°C | ±0.3 | ±0.6 | ±0.9 | |
| | | T _A = -40°C to 125°C | ±0.3 | ±0.6 | ±0.9 | |
| B _{HYS} | Magnetic hysteresis: B _{OP} - B _{RP} | T _A = 25°C | 0.18 | 0.4 | | mT |
| | | T _A = -40°C to 85°C | 0.14 | 0.4 | | |
| | | T _A = -40°C to 125°C | 0.12 | 0.4 | | |
| TMAG5134Bxx 1.3mT | | | | | | |
| B _{OP} | Magnetic threshold operate point | T _A = 25°C | ±1.05 | ±1.3 | ±1.55 | mT |
| | | T _A = -40°C to 85°C | ±0.97 | ±1.3 | ±1.63 | |
| | | T _A = -40°C to 125°C | ±0.93 | ±1.3 | ±1.67 | |
| B _{RP} | Magnetic release operate point | T _A = 25°C | ±0.65 | ±0.9 | ±1.15 | mT |
| | | T _A = -40°C to 85°C | ±0.54 | ±0.9 | ±1.26 | |
| | | T _A = -40°C to 125°C | ±0.43 | ±0.9 | ±1.37 | |
| B _{HYS} | Magnetic hysteresis: B _{OP} - B _{RP} | T _A = 25°C | 0.15 | 0.4 | | mT |
| | | T _A = -40°C to 85°C | 0.13 | 0.4 | | |
| | | T _A = -40°C to 125°C | 0.12 | 0.4 | | |
| TMAG5134Cxx 1.5mT | | | | | | |
| B _{OP} | Magnetic threshold operate point | T _A = 25°C | ±1.20 | ±1.5 | ±1.80 | mT |
| | | T _A = -40°C to 85°C | ±1.15 | ±1.5 | ±1.85 | |
| | | T _A = -40°C to 125°C | ±1.10 | ±1.5 | ±1.90 | |
| B _{RP} | Magnetic release operate point | T _A = 25°C | ±0.80 | ±1.1 | ±1.40 | mT |
| | | T _A = -40°C to 85°C | ±0.75 | ±1.1 | ±1.45 | |
| | | T _A = -40°C to 125°C | ±0.69 | ±1.1 | ±1.5 | |
| B _{HYS} | Magnetic hysteresis: B _{OP} - B _{RP} | T _A = 25°C | 0.17 | 0.4 | | mT |
| | | T _A = -40°C to 85°C | 0.14 | 0.4 | | |
| | | T _A = -40°C to 125°C | 0.12 | 0.4 | | |
| TMAG5134Exx 2mT | | | | | | |
| B _{OP} | Magnetic threshold operate point | T _A = 25°C | ±1.6 | ±2 | ±2.4 | mT |
| | | T _A = -40°C to 85°C | ±1.55 | ±2 | ±2.45 | |
| | | T _A = -40°C to 125°C | ±1.45 | ±2 | ±2.55 | |
| B _{RP} | Magnetic release operate point | T _A = 25°C | ±1.25 | ±1.6 | ±1.95 | mT |
| | | T _A = -40°C to 85°C | ±1.10 | ±1.6 | ±2.10 | |
| | | T _A = -40°C to 125°C | ±1.00 | ±1.6 | ±2.2 | |
| B _{HYS} | Magnetic hysteresis: B _{OP} - B _{RP} | T _A = 25°C | 0.17 | 0.4 | | mT |
| | | T _A = -40°C to 85°C | 0.14 | 0.4 | | |
| | | T _A = -40°C to 125°C | 0.12 | 0.4 | | |

over free-air temperature range and $V_{CC} = 1.65V$ to $5.5V$ (unless otherwise noted); Typical specifications are at $T_A = 25^\circ C$ and $V_{CC} = 3.3V$ (unless otherwise noted)

| PARAMETER | | TEST CONDITIONS | MIN | TYP | MAX | UNIT |
|--------------------------|--|--------------------------------------|------------|-----------|------------|------|
| TMAG5134Hxx 0.9mT | | | | | | |
| B_{OP} | Magnetic threshold operate point | $T_A = 25^\circ C$ | ± 0.65 | ± 0.9 | ± 1.15 | mT |
| | | $T_A = -40^\circ C$ to $85^\circ C$ | ± 0.6 | ± 0.9 | ± 1.2 | |
| | | $T_A = -40^\circ C$ to $125^\circ C$ | ± 0.6 | ± 0.9 | ± 1.25 | |
| B_{RP} | Magnetic release operate point | $T_A = 25^\circ C$ | ± 0.3 | ± 0.5 | ± 0.75 | mT |
| | | $T_A = -40^\circ C$ to $85^\circ C$ | ± 0.2 | ± 0.5 | ± 0.8 | |
| | | $T_A = -40^\circ C$ to $125^\circ C$ | ± 0.2 | ± 0.5 | ± 0.85 | |
| B_{HYS} | Magnetic hysteresis: $ B_{OP} - B_{RP} $ | $T_A = 25^\circ C$ | 0.18 | 0.4 | | mT |
| | | $T_A = -40^\circ C$ to $85^\circ C$ | 0.14 | 0.4 | | |
| | | $T_A = -40^\circ C$ to $125^\circ C$ | 0.12 | 0.4 | | |

6.7 Typical Characteristics

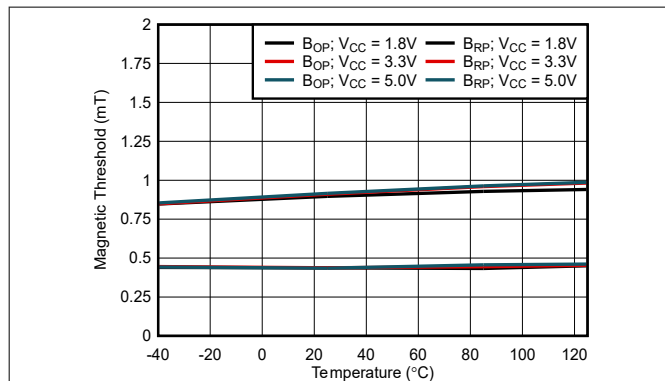

Figure 6-1. 0.9mT B_{OP} and B_{RP} Thresholds vs Temperature

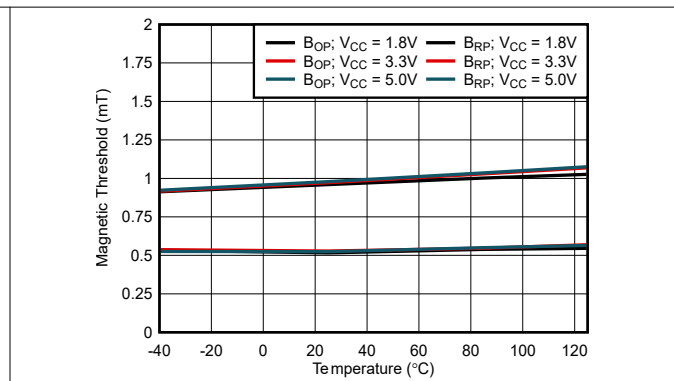

Figure 6-2. 1.0mT B_{OP} and B_{RP} Thresholds vs Temperature

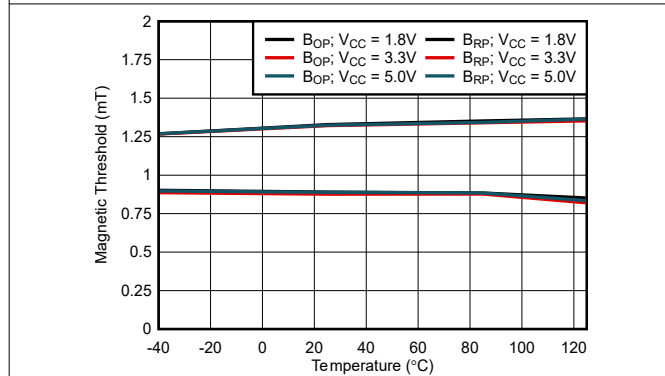

Figure 6-3. 1.3mT B_{OP} and B_{RP} Thresholds vs Temperature

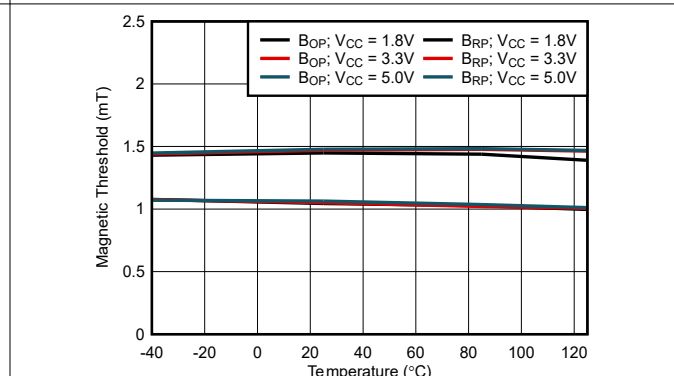

Figure 6-4. 1.5mT B_{OP} and B_{RP} Thresholds vs Temperature

6.7 Typical Characteristics (continued)

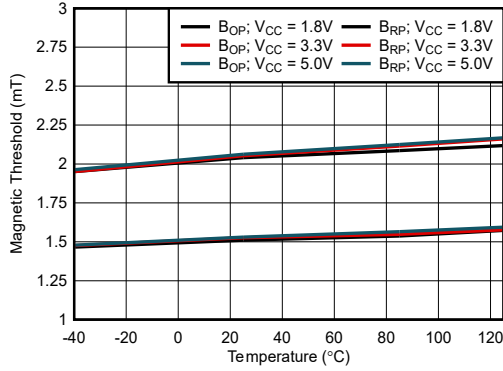

Figure 6-5. 2.0mT B_{OP} and B_{RP} Thresholds vs Temperature

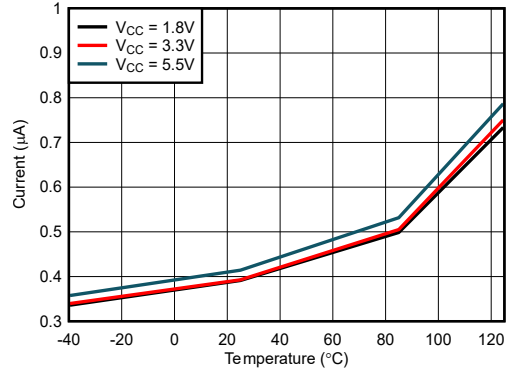

Figure 6-6. 1.25Hz I_{CCAVG} vs Temperature

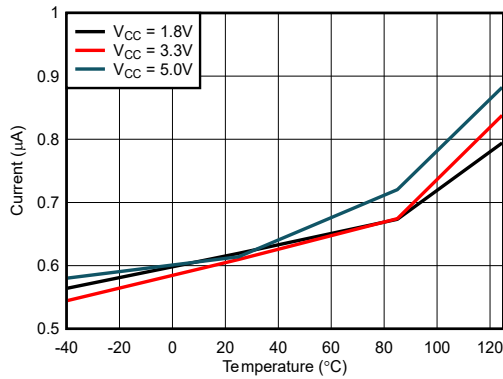

Figure 6-7. 5Hz I_{CCAVG} vs Temperature

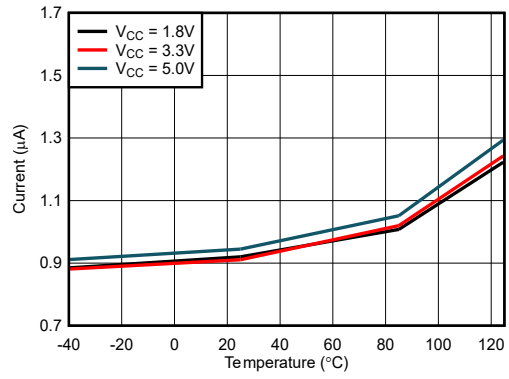

Figure 6-8. 10Hz I_{CCAVG} vs Temperature

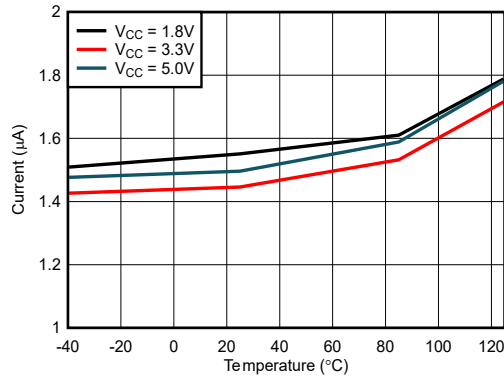

Figure 6-9. 20Hz I_{CCAVG} vs Temperature

7 Detailed Description

7.1 Overview

The TMAG5134 is a Hall-effect magnetic position sensor with a digital output that indicates when the magnetic flux density thresholds have been crossed. As an omnipolar switch, the OUT pin is sensitive to positive and negative magnetic flux density through the sensor. The X1LGA package enables a unipolar magnetic response with two outputs, where the OUT1 pin is sensitive to positive magnetic flux density and the OUT2 pin is sensitive to negative magnetic flux density. The TMAG5134 periodically samples the Hall-effect sensor according to the sampling rate. After sampling the sensor the device enters a low power sleep state to conserve power.

7.2 Functional Block Diagram

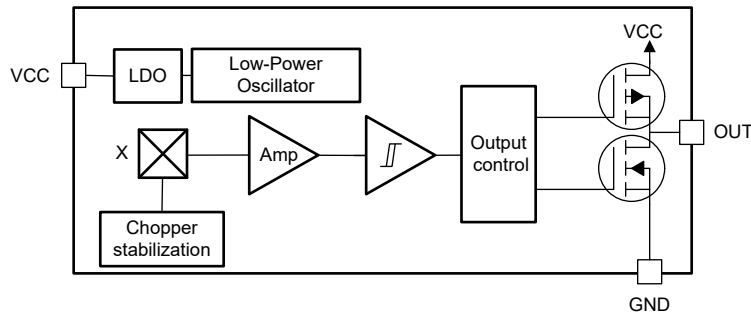

Figure 7-1. SOT-23 Block Diagram

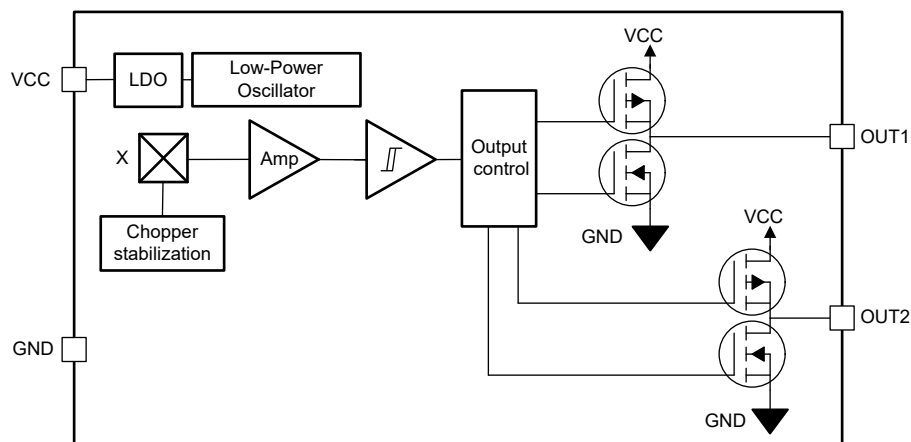

Figure 7-2. X1LGA Block Diagram

7.3 Feature Description

7.3.1 SOT-23 Magnetic Flux Density Direction

The TMAG5134 SOT-23 detects the magnetic flux density which is horizontal to the package marking surface.

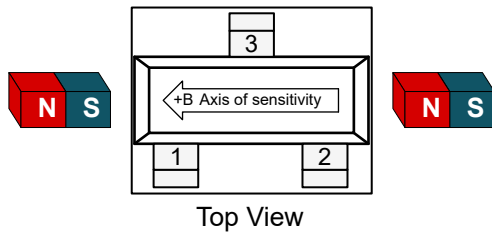

Figure 7-3. Positive Magnetic Flux Density

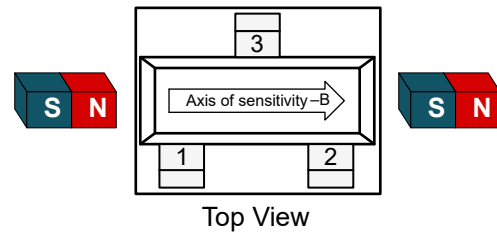

Figure 7-4. Negative Magnetic Flux Density

Magnetic flux density traveling from the pin 2 side of the package to the pin 1 side of the package is considered positive, while magnetic flux density traveling from the pin 1 side of the package to the pin 2 side of the package is considered negative.

A magnet creates a three-dimensional magnetic field that permeates the surrounding space, with field strength and direction varying at different points. This variation allows for multiple ways to induce a positive (or negative) magnetic flux density, as illustrated in Figure 7-5 and Figure 7-6.

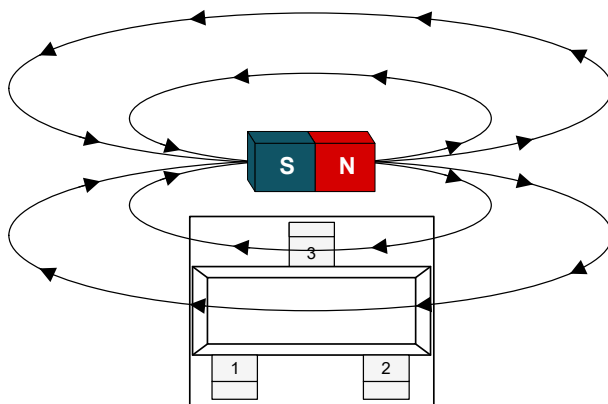

Figure 7-5. Positive Magnetic Flux Density: Magnet Offset

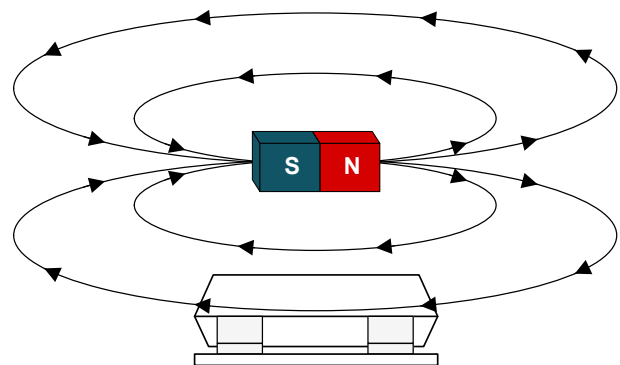

Figure 7-6. Positive Magnetic Flux Density: Magnet In-Line

7.3.2 Omnipolar Output

The TMAG5134 SOT-23 package is available with an omnipolar magnetic response. The OUT pin responds to both positive and negative magnetic flux densities. Figure 7-7 illustrates this omnipolar response with an active low output behavior.

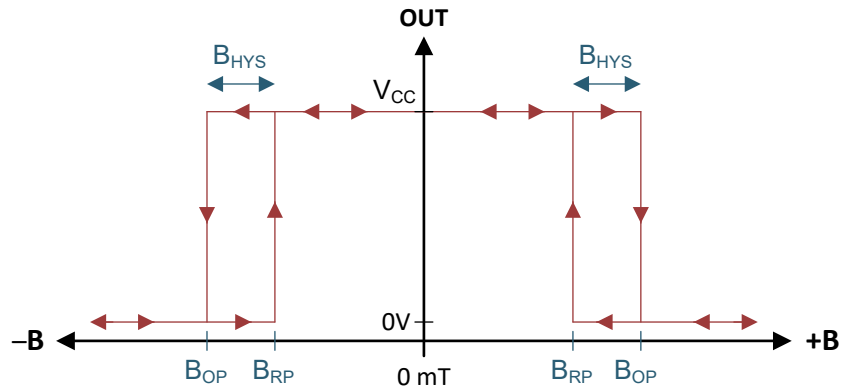

Figure 7-7. Omnipolar Output Response

7.3.3 X1LGA Magnetic Flux Direction

The TMAG5134X1LGA detects the magnetic flux density which is horizontal to the package marking surface.

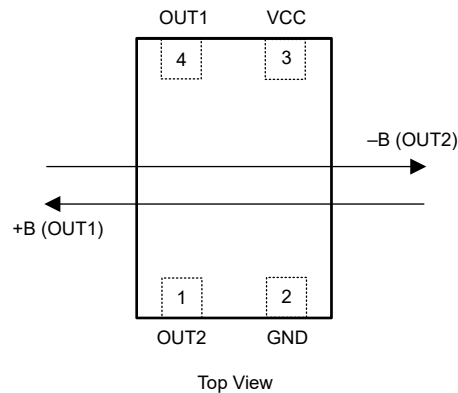

Figure 7-8. Direction of Sensitivity

Magnetic flux that travels from the pin 2 and 3 side of the package to the pin 1 and 4 side of the package is considered positive. Magnetic flux that travels from the pin 1 and 4 side of the package to the pin 2 and 3 side of the package is considered negative.

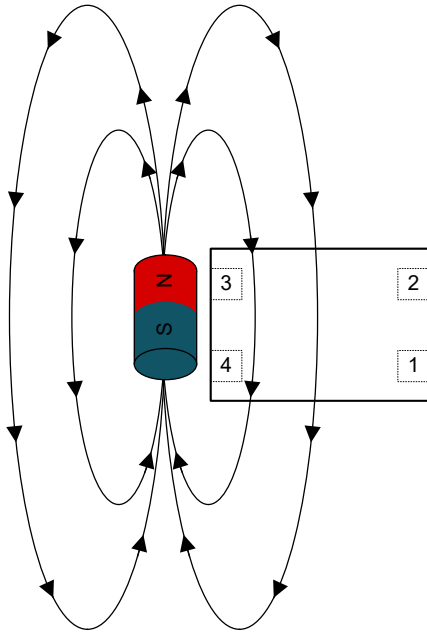

Figure 7-9. Positive Magnetic Flux Density: Magnet Offset

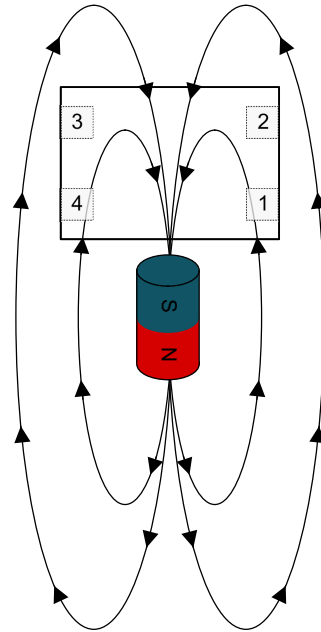

Figure 7-10. Positive Magnetic Flux Density: Magnet In-Line

7.3.4 Dual-Unipolar Output

The TMAG5134X1LGA package is available with two unipolar outputs. OUT1 responds to a positive magnetic flux density through the package, whereas OUT2 responds to a negative magnetic flux density through the package. Figure 7-11 illustrates this dual-unipolar response with an active low output behavior.

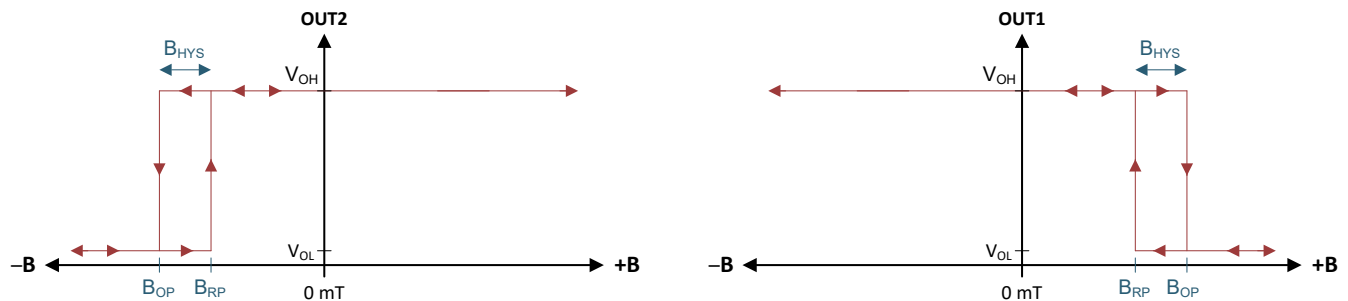

Figure 7-11. Dual-Unipolar Output Response

7.3.5 Sampling Rate

Figure 7-12 displays the start-up behavior of the TMAG5134 and some examples of the output pin voltage based on different magnetic flux density value scenarios for an active low version. When the minimum value for V_{CC} is reached, the TMAG5134 takes time t_{ON} to power up, measure the first magnetic sample and set the output value. When the output value is set, the output is latched and the device enters a low power sleep state. After each t_S time has passed, the device measures a new sample and updates the output if necessary. If the magnetic field does not change between periods, the output also does not change.

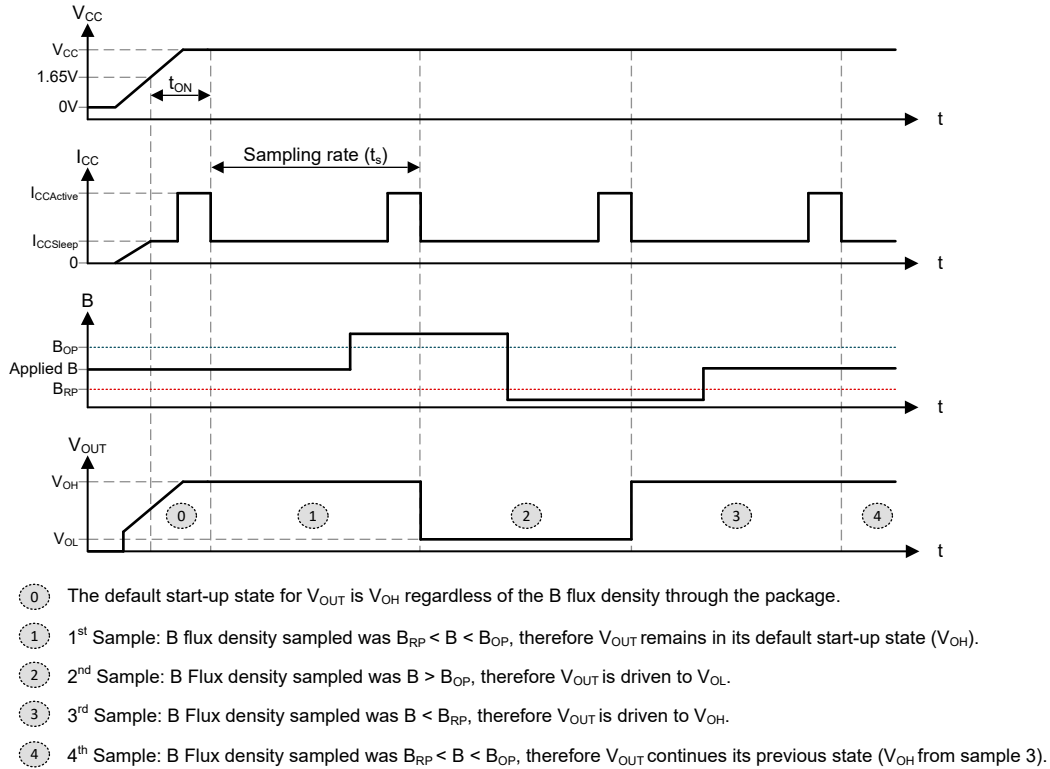

Figure 7-12. Timing and Output Diagram

7.3.6 Output Logic Tables

Table 7-1 and Table 7-2 shows the output status during different external magnetic field conditions (B_{EXT}). When the B_{EXT} is between B_{RP} and B_{OP} , the TMAG5134 output will retain the previous state.

Table 7-1. TMAG5134 Active-Low Output Logic Table

| Field Condition | Unipolar | | Omnipolar |
|---------------------------------------|-----------------------|------|-----------|
| | OUT1 | OUT2 | OUT |
| $B_{EXT} \leq -B_{OP}$ | H | L | L |
| $-B_{RP} \leq B_{EXT} \leq B_{RP}$ | H | H | H |
| $B_{RP} \leq B_{EXT}$ | L | H | L |
| $ B_{RP} \leq B_{EXT} \leq B_{OP} $ | Retain Previous State | | |

Table 7-2. TMAG5134 Active-High Output Logic Table

| Field Condition | Unipolar | | Omnipolar |
|---------------------------------------|-----------------------|------|-----------|
| | OUT1 | OUT2 | OUT |
| $B_{EXT} \leq -B_{OP}$ | L | H | H |
| $-B_{RP} \leq B_{EXT} \leq B_{RP}$ | L | L | L |
| $B_{RP} \leq B_{EXT}$ | H | L | H |
| $ B_{RP} \leq B_{EXT} \leq B_{OP} $ | Retain Previous State | | |

7.3.7 Hall Element Location

Figure 7-13 shows the sensing element location inside the X1LGA package.

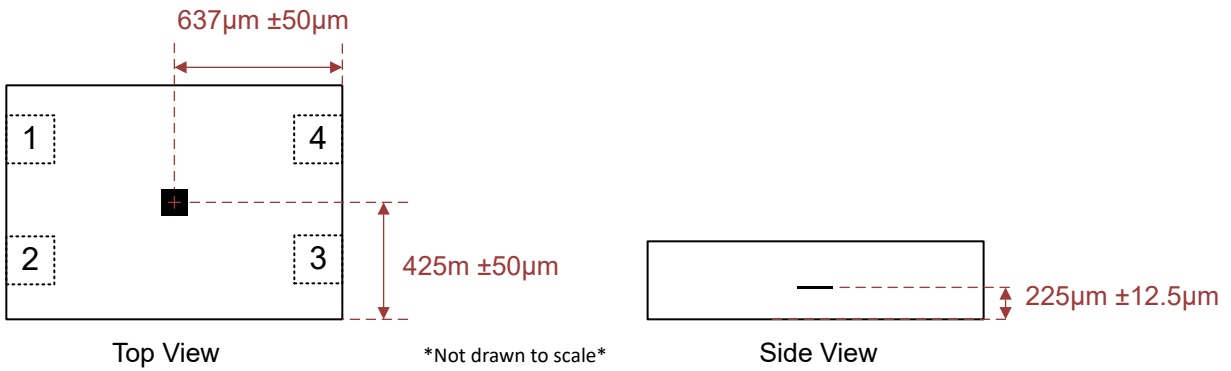

Figure 7-13. DBV Hall Element Location

7.4 Device Functional Modes

The TMAG5134 always operates in a duty-cycled mode as described in the [Electrical Characteristics](#) section when the [Recommended Operating Conditions](#) are met.

8 Application and Implementation

Note

Information in the following applications sections is not part of the TI component specification, and TI does not warrant its accuracy or completeness. TI's customers are responsible for determining suitability of components for their purposes, as well as validating and testing their design implementation to confirm system functionality.

8.1 Application Information

The TMAG5134 is a Hall-effect switch used to detect the proximity of a magnet, which is often attached to a movable component within the system. When the magnet comes sufficiently close to the sensor and induces a magnetic flux density that exceeds the B_{OP} threshold along the TMAG5134 axis of sensitivity, the output of the sensor is pulled low to GND for an active low variant. This low output can be read by a GPIO pin on a controller, enabling the system to recognize that the magnet has crossed the threshold, thereby indicating the position or movement of the component. This application is common in various fields, such as industrial automation and consumer electronics, where precise detection of position or movement is critical.

Due to the complex, non-linear behavior of magnets, determining the appropriate magnet characteristics required to verify the system works as intended can be difficult. Therefore, TI recommends to begin the design process with experimentation to solve for a design that works. To help facilitate rapid design iteration, the [TI Magnetic Sense Simulator \(TIMSS\)](#) web tool provides a visual interface that emulates typical sensor performance in system designs. TIMSS simulations provide an understanding of expected magnetic field behavior across a range of motion, and the simulations are run in a few seconds.

8.2 Typical Application

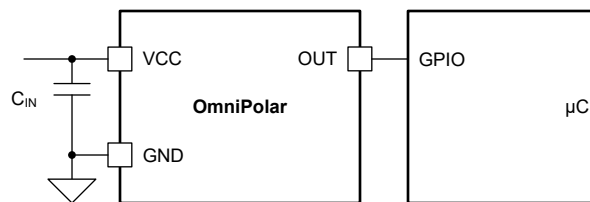

Figure 8-1. Typical Application Schematic

8.2.1 Design Requirements

This section provides an example using the [TI Magnetic Sense Simulator \(TIMSS\)](#) web tool for a magnet hinge application. The following table lists the design parameters related to the movement of the magnet on a hinge.

Table 8-1. Design Parameters

| PARAMETER | VALUE |
|-----------------------------|----------------|
| Supply voltage (V_{CC}) | 3.3V |
| Bypass capacitor | 0.1 μ F |
| Part number | TMAG5134B1D |
| Magnet range of motion | 10mm hinge |
| Magnet shape | Axial Cylinder |
| Magnet width | 2mm |
| Magnet height | 1mm |
| Magnet type | N35 |

8.2.2 Detailed Design Procedure

As the magnet travels from the starting position 60° to the final position 0°, the magnetic flux density seen by the TMAG5134 across the axis of sensitivity changes.

At the magnet starting position, the TMAG5134 output is high because the magnetic flux density is less than B_{OP} . As the magnet moves along the hinge arc towards the sensor, the magnetic flux density crosses the B_{OP} threshold of the TMAG5134 at an angle of 15°, making the output go low. If the hinge opens, the magnetic flux density decreases, and at an angle of 20° the B_{RP} threshold is crossed and the output goes high.

8.2.3 Application Performance Plots

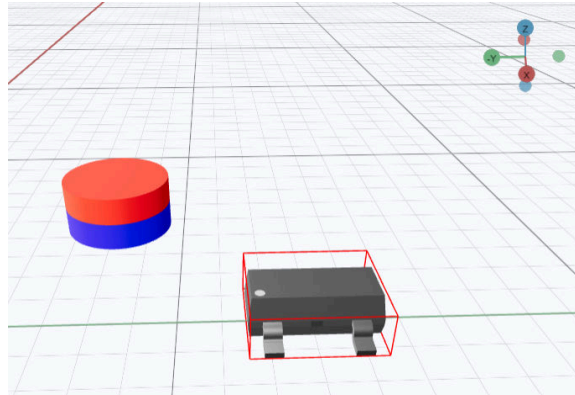

Figure 8-2. TIMSS Simulation Hinge Setup

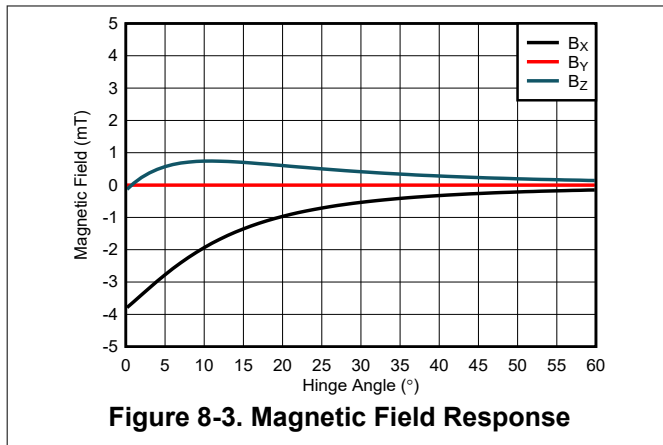

Figure 8-3. Magnetic Field Response

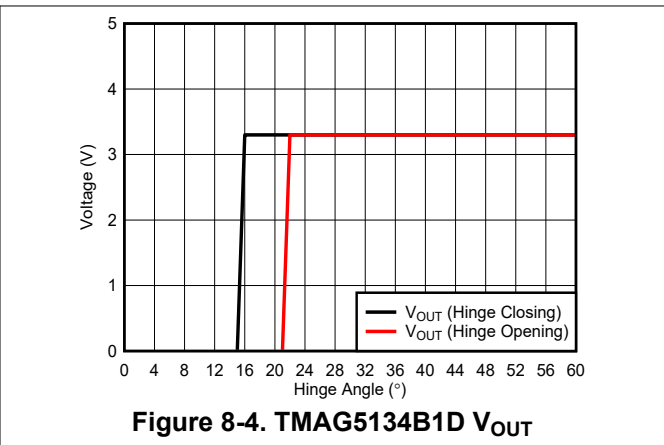

Figure 8-4. TMAG5134B1D V_{OUT}

8.3 Power Supply Recommendations

The TMAG5134 supports a supply range of 1.65V to 5.5V. TI recommends a bypass capacitor of at least 0.1 μ F between the sensor power supply and ground to help filter out voltage fluctuations and noise in the power supply. Best practice is to place this bypass capacitor as close to the supply pin of the sensor as possible.

8.4 Layout

8.4.1 Layout Guidelines

Magnetic fields pass through most non-ferromagnetic materials with no significant disturbance. Embedding Hall-effect sensors within plastic or aluminum enclosures and sensing magnets on the outside is common practice. Magnetic fields also easily pass through most printed circuit boards (PCBs), which makes the placement of the magnet on the opposite side possible.

8.4.2 Layout Example

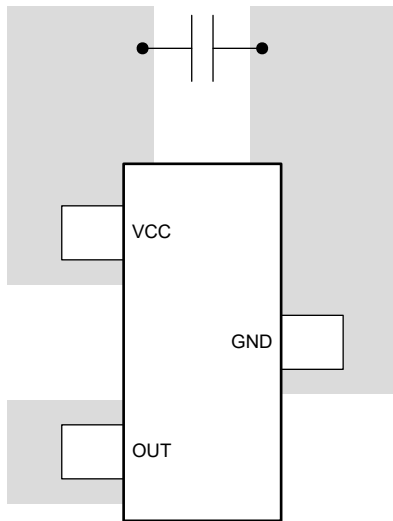

Figure 8-5. SOT-23 Layout Example

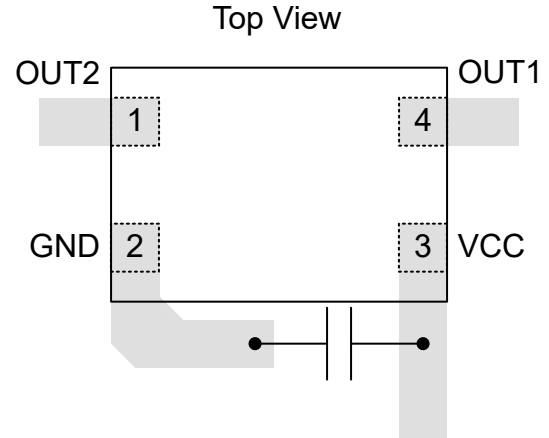

Figure 8-6. X1LGA Layout Example

9 Device and Documentation Support

TI offers an extensive line of development tools. Tools and software to evaluate the performance of the device, generate code, and develop solutions are listed below.

9.1 Documentation Support

9.1.1 Related Documentation

- Texas Instruments, [TMAG5134 Evaluation Module User's Guide](#)
- Texas Instruments, [Replacing Reed and Magnetostrictive Switches With Cost-Effective, Low-Power Hall-Effect Switches](#)
- Texas Instruments, [How Hall-Effect Sensors are Used in Electronic Smart Locks](#)

9.2 Receiving Notification of Documentation Updates

To receive notification of documentation updates, navigate to the device product folder on ti.com. Click on *Notifications* to register and receive a weekly digest of any product information that has changed. For change details, review the revision history included in any revised document.

9.3 Support Resources

TI E2E™ [support forums](#) are an engineer's go-to source for fast, verified answers and design help — straight from the experts. Search existing answers or ask your own question to get the quick design help you need.

Linked content is provided "AS IS" by the respective contributors. They do not constitute TI specifications and do not necessarily reflect TI's views; see TI's [Terms of Use](#).

9.4 Trademarks

TI E2E™ is a trademark of Texas Instruments.
All trademarks are the property of their respective owners.

9.5 Electrostatic Discharge Caution



This integrated circuit can be damaged by ESD. Texas Instruments recommends that all integrated circuits be handled with appropriate precautions. Failure to observe proper handling and installation procedures can cause damage.

ESD damage can range from subtle performance degradation to complete device failure. Precision integrated circuits may be more susceptible to damage because very small parametric changes could cause the device not to meet its published specifications.

9.6 Glossary

[TI Glossary](#) This glossary lists and explains terms, acronyms, and definitions.

10 Revision History

NOTE: Page numbers for previous revisions may differ from page numbers in the current version.

Changes from February 5, 2026 to March 24, 2026 (from Revision E (February 2026) to Revision F (March 2026))

| | Page |
|---|------|
| • Added TMAG5124Exx to <i>Magnetic Characteristics</i> Table..... | 7 |
| • Added 2.0mT Threshold graphs to <i>Typical Characteristics</i> section..... | 8 |

Changes from Revision D (November 2025) to Revision E (February 2026)

| | Page |
|---|------|
| • Added 0.9mT B _{OP} version to Features list..... | 1 |
| • Added TMAG5134E4CZFC to <i>Device Comparison Table</i> | 3 |
| • Added TMAG5134Hxx to <i>Magnetic Characteristics</i> Table..... | 7 |
| • Added 0.9mT Threshold graphs to <i>Typical Characteristics</i> section..... | 8 |

| | |
|--|----|
| • Added <i>Logic Tables</i> section..... | 14 |
|--|----|

Changes from Revision C (November 2025) to Revision D (November 2025) Page

| | |
|--|---|
| • Added TMAG5134C1ADBV to <i>Device Comparison Table</i> | 3 |
|--|---|

Changes from Revision B (September 2025) to Revision C (November 2025) Page

| | |
|---|---|
| • Changed 10Hz $T_A = 25^\circ\text{C}$ I_{CCAVG} maximum from 1.3 μA to 1.42 μA | 6 |
| • Changed 10Hz $T_A = -40^\circ\text{C}$ to 85°C I_{CCAVG} maximum from 1.42 μA to 1.62 μA | 6 |
| • Changed 10Hz $T_A = -40^\circ\text{C}$ to 125°C I_{CCAVG} maximum from 1.64 μA to 2.19 μA | 6 |
| • Added TMAG5134Cxx to <i>Magnetic Characteristics Table</i> | 7 |
| • Added 10Hz sampling rate graphs to <i>Typical Characteristics</i> section..... | 8 |
| • Added 1.5mT Threshold graphs to <i>Typical Characteristics</i> section..... | 8 |

11 Mechanical, Packaging, and Orderable Information

The following pages include mechanical, packaging, and orderable information. This information is the most current data available for the designated devices. This data is subject to change without notice and revision of this document. For browser-based versions of this data sheet, refer to the left-hand navigation.

PACKAGING INFORMATION

| Orderable part number | Status (1) | Material type (2) | Package Pins | Package qty Carrier | RoHS (3) | Lead finish/ Ball material (4) | MSL rating/ Peak reflow (5) | Op temp (°C) | Part marking (6) |
|---------------------------------|---------------|----------------------|------------------|-----------------------|-------------|--------------------------------------|-----------------------------------|--------------|---------------------|
| PMAG5134E4CZFCR | Active | Preproduction | NFBGA (ZFC) 4 | 3000 LARGE T&R | Yes | NIAU | Level-2-260C-1 YEAR | - | |
| TMAG5134A1CDBVR | Active | Production | SOT-23 (DBV) 3 | 3000 LARGE T&R | Yes | SN | Level-1-260C-UNLIM | -40 to 125 | 4A1C |
| TMAG5134B1ADBVR | Active | Production | SOT-23 (DBV) 3 | 3000 LARGE T&R | Yes | SN | Level-1-260C-UNLIM | -40 to 125 | 4B1A |
| TMAG5134B1BDBVR | Active | Production | SOT-23 (DBV) 3 | 3000 LARGE T&R | Yes | SN | Level-1-260C-UNLIM | -40 to 125 | 4B1B |
| TMAG5134B1DDBVR | Active | Production | SOT-23 (DBV) 3 | 3000 LARGE T&R | Yes | SN | Level-1-260C-UNLIM | -40 to 125 | 4B1D |
| TMAG5134B5DZFCR | Active | Production | NFBGA (ZFC) 4 | 3000 LARGE T&R | Yes | NIAU | Level-2-260C-1 YEAR | -40 to 125 | |
| TMAG5134C1ADBVR | Active | Production | SOT-23 (DBV) 3 | 3000 LARGE T&R | Yes | SN | Level-1-260C-UNLIM | -40 to 125 | 4C1A |
| TMAG5134C1CDBVR | Active | Production | SOT-23 (DBV) 3 | 3000 LARGE T&R | Yes | SN | Level-1-260C-UNLIM | -40 to 125 | 4C1C |
| TMAG5134E1DDBVR | Active | Production | SOT-23 (DBV) 3 | 3000 LARGE T&R | Yes | SN | Level-1-260C-UNLIM | -40 to 125 | 4E1D |
| TMAG5134H1CDBVR | Active | Production | SOT-23 (DBV) 3 | 3000 LARGE T&R | Yes | SN | Level-1-260C-UNLIM | -40 to 125 | 4H1C |

(1) **Status:** For more details on status, see our [product life cycle](#).

(2) **Material type:** When designated, preproduction parts are prototypes/experimental devices, and are not yet approved or released for full production. Testing and final process, including without limitation quality assurance, reliability performance testing, and/or process qualification, may not yet be complete, and this item is subject to further changes or possible discontinuation. If available for ordering, purchases will be subject to an additional waiver at checkout, and are intended for early internal evaluation purposes only. These items are sold without warranties of any kind.

(3) **RoHS values:** Yes, No, RoHS Exempt. See the [TI RoHS Statement](#) for additional information and value definition.

(4) **Lead finish/Ball material:** Parts may have multiple material finish options. Finish options are separated by a vertical ruled line. Lead finish/Ball material values may wrap to two lines if the finish value exceeds the maximum column width.

(5) **MSL rating/Peak reflow:** The moisture sensitivity level ratings and peak solder (reflow) temperatures. In the event that a part has multiple moisture sensitivity ratings, only the lowest level per JEDEC standards is shown. Refer to the shipping label for the actual reflow temperature that will be used to mount the part to the printed circuit board.

(6) **Part marking:** There may be an additional marking, which relates to the logo, the lot trace code information, or the environmental category of the part.

Multiple part markings will be inside parentheses. Only one part marking contained in parentheses and separated by a "~" will appear on a part. If a line is indented then it is a continuation of the previous line and the two combined represent the entire part marking for that device.

Important Information and Disclaimer: The information provided on this page represents TI's knowledge and belief as of the date that it is provided. TI bases its knowledge and belief on information provided by third parties, and makes no representation or warranty as to the accuracy of such information. Efforts are underway to better integrate information from third parties. TI has taken and continues to take reasonable steps to provide representative

and accurate information but may not have conducted destructive testing or chemical analysis on incoming materials and chemicals. TI and TI suppliers consider certain information to be proprietary, and thus CAS numbers and other limited information may not be available for release.

In no event shall TI's liability arising out of such information exceed the total purchase price of the TI part(s) at issue in this document sold by TI to Customer on an annual basis.

TAPE AND REEL INFORMATION

QUADRANT ASSIGNMENTS FOR PIN 1 ORIENTATION IN TAPE

*All dimensions are nominal

| Device | Package Type | Package Drawing | Pins | SPQ | Reel Diameter (mm) | Reel Width W1 (mm) | A0 (mm) | B0 (mm) | K0 (mm) | P1 (mm) | W (mm) | Pin1 Quadrant |
|-----------------|--------------|-----------------|------|------|--------------------|--------------------|---------|---------|---------|---------|--------|---------------|
| TMAG5134A1CDBVR | SOT-23 | DBV | 3 | 3000 | 178.0 | 9.0 | 3.3 | 3.2 | 1.4 | 4.0 | 8.0 | Q3 |
| TMAG5134B1ADBVR | SOT-23 | DBV | 3 | 3000 | 178.0 | 9.0 | 3.3 | 3.2 | 1.4 | 4.0 | 8.0 | Q3 |
| TMAG5134B1BDBVR | SOT-23 | DBV | 3 | 3000 | 178.0 | 9.0 | 3.3 | 3.2 | 1.4 | 4.0 | 8.0 | Q3 |
| TMAG5134B1DDBVR | SOT-23 | DBV | 3 | 3000 | 178.0 | 9.0 | 3.3 | 3.2 | 1.4 | 4.0 | 8.0 | Q3 |
| TMAG5134B5DZFCR | NFBGA | ZFC | 4 | 3000 | 180.0 | 8.4 | 1.07 | 1.47 | 0.52 | 4.0 | 8.0 | Q3 |
| TMAG5134C1ADBVR | SOT-23 | DBV | 3 | 3000 | 178.0 | 9.0 | 3.3 | 3.2 | 1.4 | 4.0 | 8.0 | Q3 |
| TMAG5134C1CDBVR | SOT-23 | DBV | 3 | 3000 | 178.0 | 9.0 | 3.3 | 3.2 | 1.4 | 4.0 | 8.0 | Q3 |
| TMAG5134E1DDBVR | SOT-23 | DBV | 3 | 3000 | 178.0 | 9.0 | 3.3 | 3.2 | 1.4 | 4.0 | 8.0 | Q3 |
| TMAG5134H1CDBVR | SOT-23 | DBV | 3 | 3000 | 178.0 | 9.0 | 3.3 | 3.2 | 1.4 | 4.0 | 8.0 | Q3 |

TAPE AND REEL BOX DIMENSIONS

*All dimensions are nominal

| Device | Package Type | Package Drawing | Pins | SPQ | Length (mm) | Width (mm) | Height (mm) |
|-----------------|--------------|-----------------|------|------|-------------|------------|-------------|
| TMAG5134A1CDBVR | SOT-23 | DBV | 3 | 3000 | 190.0 | 190.0 | 30.0 |
| TMAG5134B1ADBVR | SOT-23 | DBV | 3 | 3000 | 190.0 | 190.0 | 30.0 |
| TMAG5134B1BDBVR | SOT-23 | DBV | 3 | 3000 | 190.0 | 190.0 | 30.0 |
| TMAG5134B1DDBVR | SOT-23 | DBV | 3 | 3000 | 190.0 | 190.0 | 30.0 |
| TMAG5134B5DZFCR | NFBGA | ZFC | 4 | 3000 | 210.0 | 185.0 | 35.0 |
| TMAG5134C1ADBVR | SOT-23 | DBV | 3 | 3000 | 190.0 | 190.0 | 30.0 |
| TMAG5134C1CDBVR | SOT-23 | DBV | 3 | 3000 | 190.0 | 190.0 | 30.0 |
| TMAG5134E1DDBVR | SOT-23 | DBV | 3 | 3000 | 190.0 | 190.0 | 30.0 |
| TMAG5134H1CDBVR | SOT-23 | DBV | 3 | 3000 | 190.0 | 190.0 | 30.0 |

EXAMPLE BOARD LAYOUT

DBV0003A

SOT-23 - 1.45 mm max height

SMALL OUTLINE TRANSISTOR

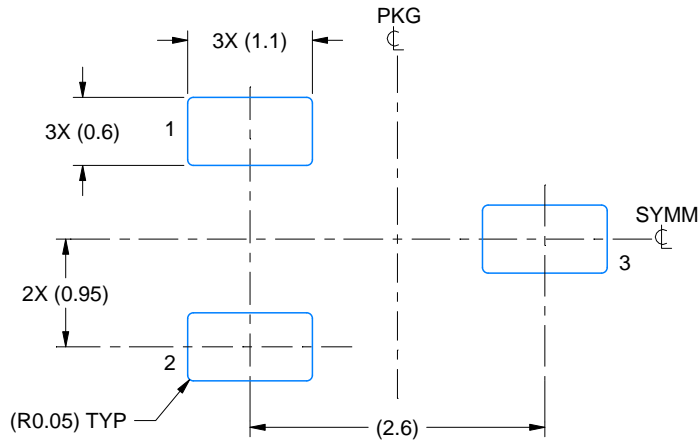

LAND PATTERN EXAMPLE
EXPOSED METAL SHOWN
SCALE:15X

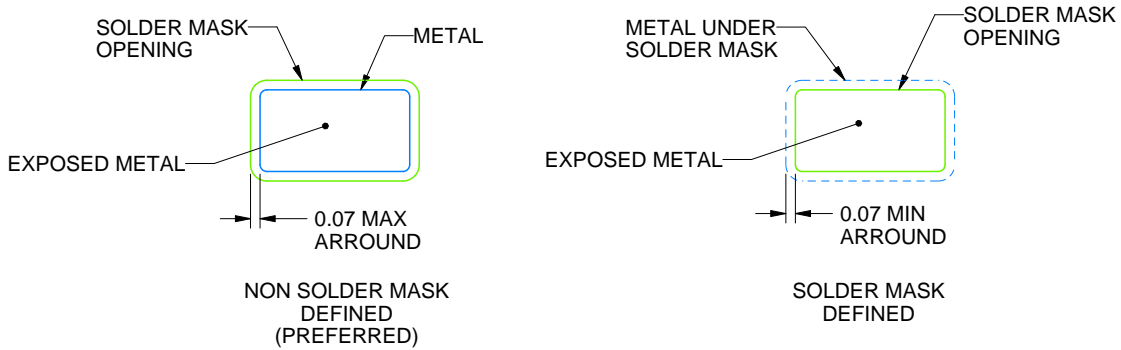

SOLDER MASK DETAILS

4220743/D 08/2024

NOTES: (continued)

- 6. Publication IPC-7351 may have alternate designs.
- 7. Solder mask tolerances between and around signal pads can vary based on board fabrication site.

EXAMPLE STENCIL DESIGN

DBV0003A

SOT-23 - 1.45 mm max height

SMALL OUTLINE TRANSISTOR

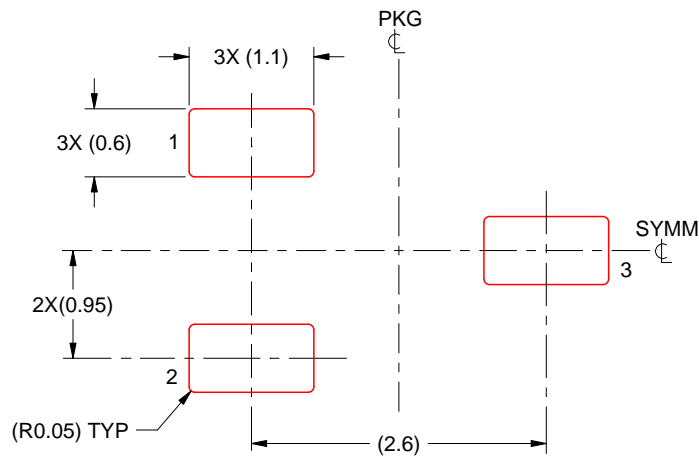

SOLDER PASTE EXAMPLE
BASED ON 0.125 mm THICK STENCIL
SCALE:15X

4220743/D 08/2024

NOTES: (continued)

8. Laser cutting apertures with trapezoidal walls and rounded corners may offer better paste release. IPC-7525 may have alternate design recommendations.
9. Board assembly site may have different recommendations for stencil design.

ZFC0004A

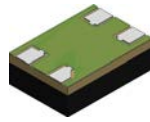

PACKAGE OUTLINE

X1LGA - 0.42 mm max height

LAND GRID ARRAY

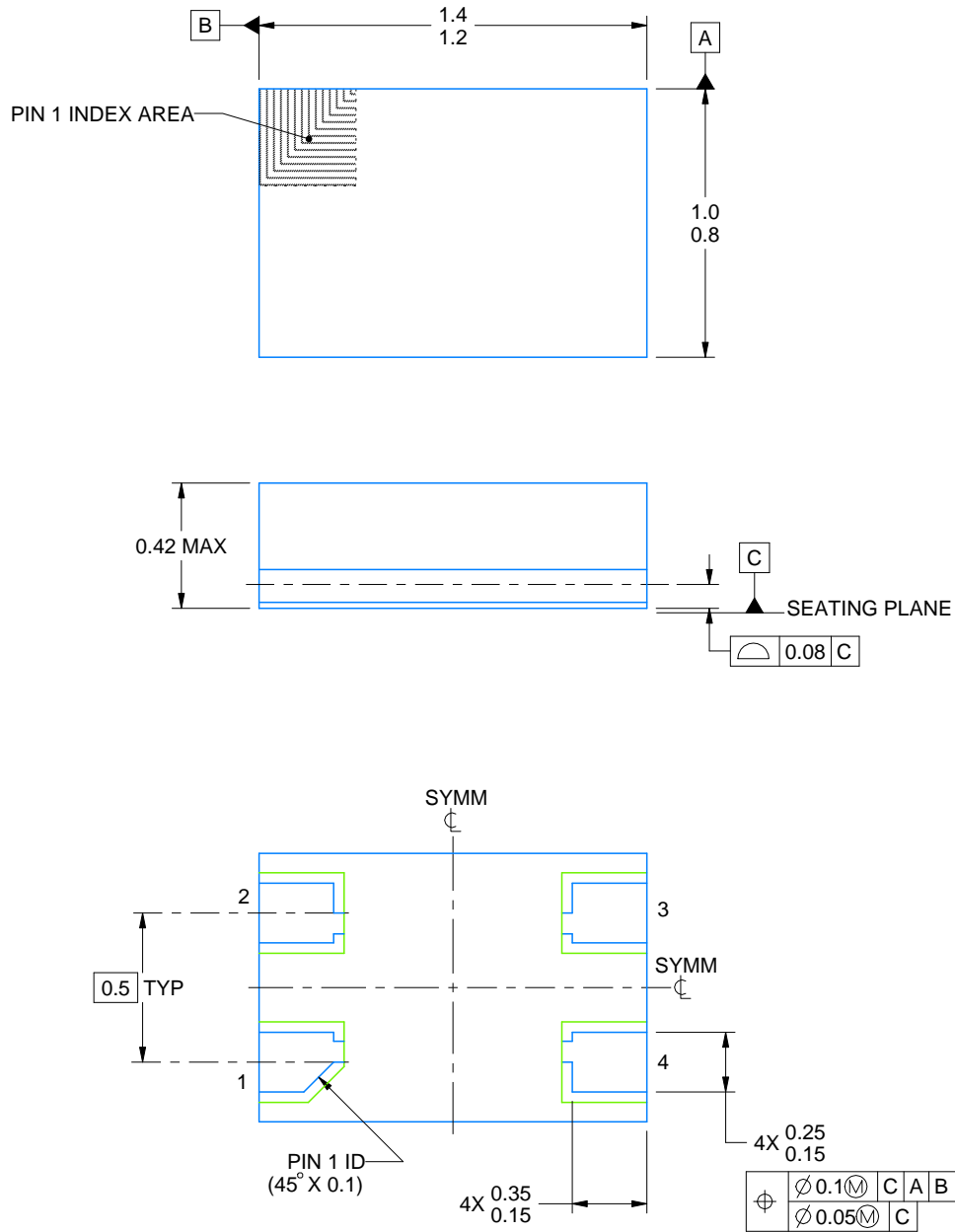

4229561/C 10/2024

NOTES:

1. All linear dimensions are in millimeters. Any dimensions in parenthesis are for reference only. Dimensioning and tolerancing per ASME Y14.5M.
2. This drawing is subject to change without notice.

EXAMPLE BOARD LAYOUT

ZFC0004A

X1LGA - 0.42 mm max height

LAND GRID ARRAY

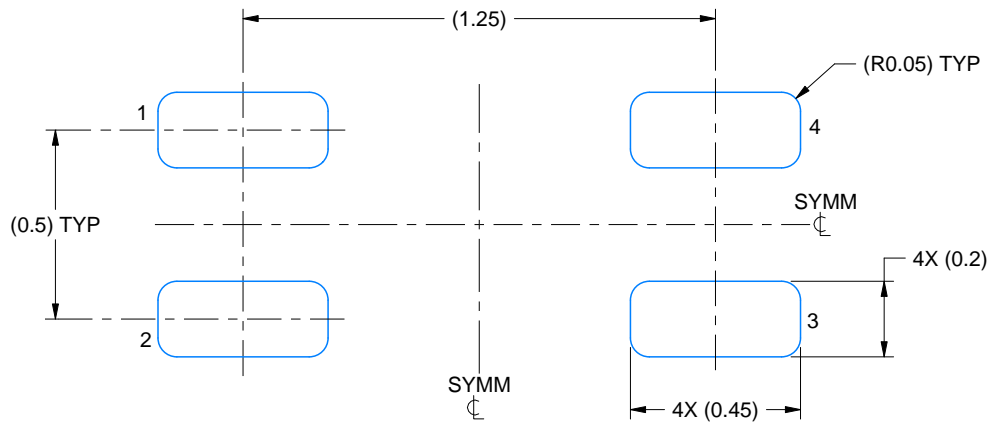

LAND PATTERN EXAMPLE

EXPOSED METAL SHOWN
SCALE: 50X

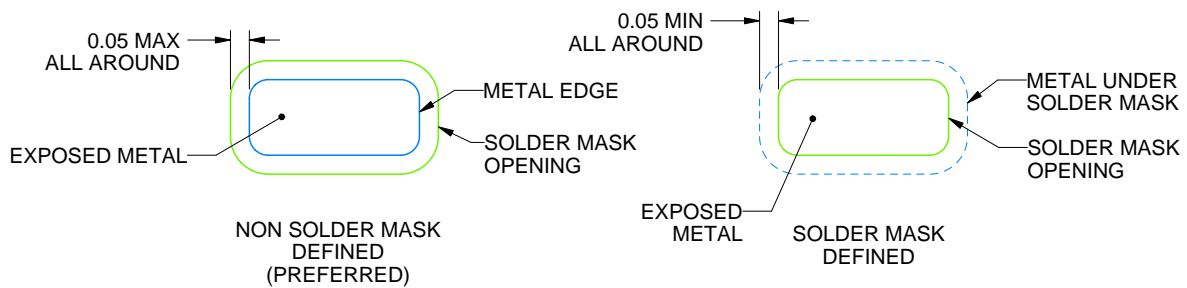

SOLDER MASK DETAILS

NOT TO SCALE

4229561/C 10/2024

NOTES: (continued)

- Final dimensions may vary due to manufacturing tolerance considerations and also routing constraints. For information, see Texas Instruments literature number SPRAA99 (www.ti.com/lit/spraa99).

EXAMPLE STENCIL DESIGN

ZFC0004A

X1LGA - 0.42 mm max height

LAND GRID ARRAY

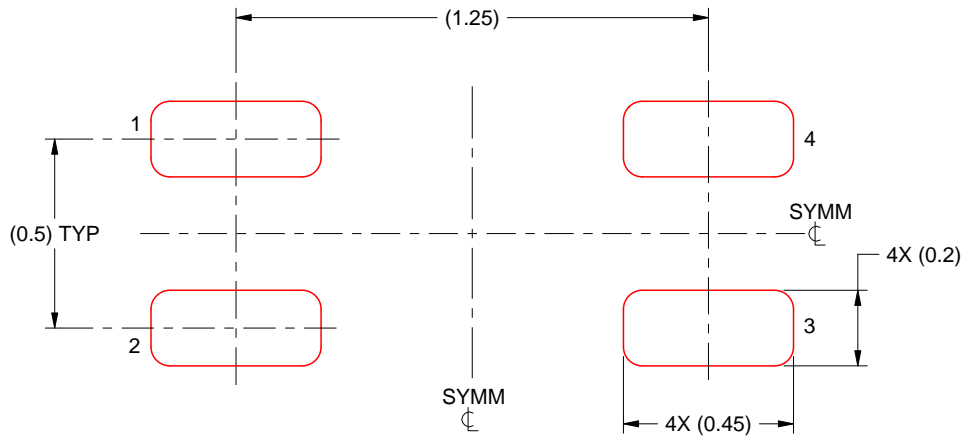

SOLDER PASTE EXAMPLE
BASED ON 0.100 mm THICK STENCIL
SCALE: 50X

4229561/C 10/2024

NOTES: (continued)

4. Laser cutting apertures with trapezoidal walls and rounded corners may offer better paste release.

IMPORTANT NOTICE AND DISCLAIMER

TI PROVIDES TECHNICAL AND RELIABILITY DATA (INCLUDING DATASHEETS), DESIGN RESOURCES (INCLUDING REFERENCE DESIGNS), APPLICATION OR OTHER DESIGN ADVICE, WEB TOOLS, SAFETY INFORMATION, AND OTHER RESOURCES "AS IS" AND WITH ALL FAULTS, AND DISCLAIMS ALL WARRANTIES, EXPRESS AND IMPLIED, INCLUDING WITHOUT LIMITATION ANY IMPLIED WARRANTIES OF MERCHANTABILITY, FITNESS FOR A PARTICULAR PURPOSE OR NON-INFRINGEMENT OF THIRD PARTY INTELLECTUAL PROPERTY RIGHTS.

These resources are intended for skilled developers designing with TI products. You are solely responsible for (1) selecting the appropriate TI products for your application, (2) designing, validating and testing your application, and (3) ensuring your application meets applicable standards, and any other safety, security, regulatory or other requirements.

These resources are subject to change without notice. TI grants you permission to use these resources only for development of an application that uses the TI products described in the resource. Other reproduction and display of these resources is prohibited. No license is granted to any other TI intellectual property right or to any third party intellectual property right. TI disclaims responsibility for, and you fully indemnify TI and its representatives against any claims, damages, costs, losses, and liabilities arising out of your use of these resources.

TI's products are provided subject to [TI's Terms of Sale](#), [TI's General Quality Guidelines](#), or other applicable terms available either on ti.com or provided in conjunction with such TI products. TI's provision of these resources does not expand or otherwise alter TI's applicable warranties or warranty disclaimers for TI products. Unless TI explicitly designates a product as custom or customer-specified, TI products are standard, catalog, general purpose devices.

TI objects to and rejects any additional or different terms you may propose.

Copyright © 2026, Texas Instruments Incorporated

Last updated 10/2025