

- Low Voltage Operation . . . 2.5 V to 7 V
- Low Power . . . 3.5 mA
(f = 500 kHz, Duty = 50%)
- Internal Undervoltage Lockout Protection
- Internal Short Circuit Protection
- Wide Operating Frequency . . . 50 kHz to 1 MHz
- Internal Precision Reference . . . 1.25 V ±1% (25°C)
- On/Off Switch for CH1/3 Pair and Ch2 (see Function Table)
- 0 to 100% Dead Time Control
- Totem Pole Output Stage
- Small Package . . . 16 Pin TSSOP

PW PACKAGE
(TOP VIEW)

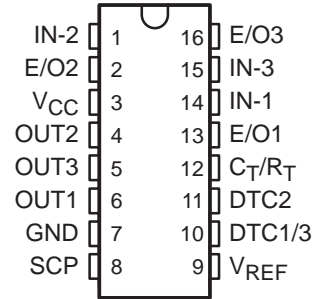

description

The TPS5100 is a triple PWM control circuit, primarily designed to compose the power supply for LCD display. Each PWM channel has own error amplifier, PWM comparator, dead-time control and output driver. The trimmed voltage reference, oscillator, undervoltage lockout and short circuit protection are common for all channels.

This device includes two boost exclusive circuits (ch1,3) and a buck-boost exclusive circuit (ch2). The operating frequency is set with external resistor and capacitor, and dead time is continuously adjustable from 0% to 100% duty cycle with resistive divider network. Soft start function can be implemented by adding a capacitor to dead time divider network. Two dead time control inputs are assigned for ch1,3 pair and ch2 individually and each dead time control input can be used to control on/off operation. TPS5100 can operate from 2.5 V supply voltage and ch1,3 pair and ch2 operate with reverse phase switching each other to achieve efficient operation in low power and battery powered system.

The TPS5100 is characterized for operation from -20°C to 85°C.

FUNCTION TABLE

CONDITION	OUTPUT		
	CH-1	CH-2	CH-3
DTC1/3 > 0.3 V, DTC2 > 0.3 V	ON H	ON L	ON H
DTC1/3 > 0.3 V, DTC2 < 0.2 V	ON H	OFF H	ON H
DTC1/3 < 0.2 V, DTC2 > 0.3 V	OFF L	ON L	OFF L
DTC1/3 < 0.2 V, DTC2 < 0.2 V	OFF L	OFF H	OFF L

AVAILABLE OPTIONS

T _A	PACKAGE
	TSSOP (PW)
-20°C to 85°C	TPS5100PW



Please be aware that an important notice concerning availability, standard warranty, and use in critical applications of Texas Instruments semiconductor products and disclaimers thereto appears at the end of this data sheet.

TPS5100 TRIPLE-CHANNEL PWM CONTROL CIRCUITS

SLVS169 – JANUARY 2000

functional block diagram

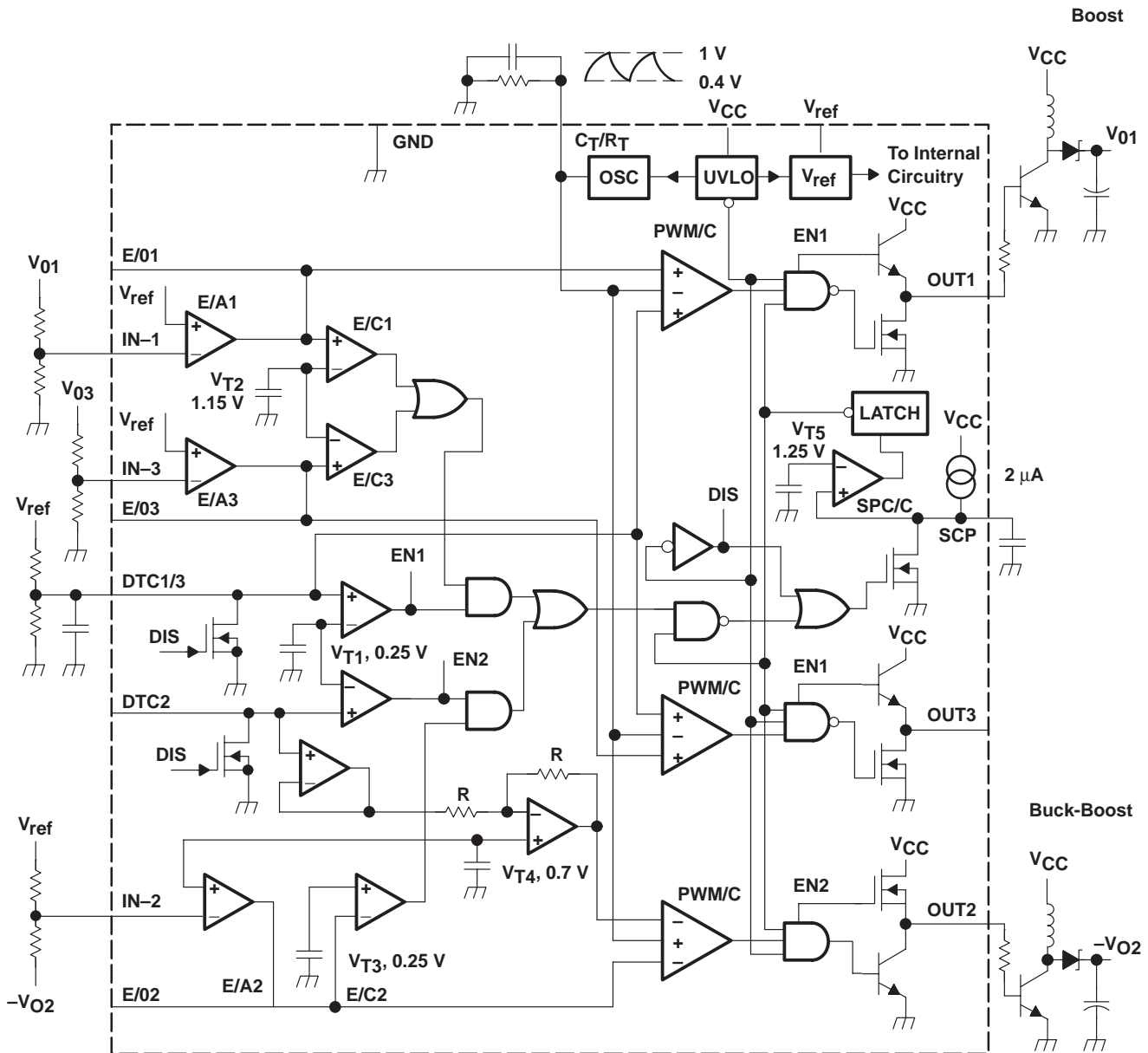

NOTE A: All voltages and currents listed are nominal.

electrical characteristics over recommended operating free-air temperature range, $V_{CC} = 3.3\text{ V}$ (unless otherwise noted) (see Note 1)

PARAMETER		TEST CONDITIONS	MIN	TYP	MAX	UNIT
V_{REF}	Reference voltage	$I_{REF} = -1\text{ mA}$, $T_A = 25^\circ\text{C}$	1.237	1.250	1.263	V
$V_{REF(dev)}$	Reference voltage change with T_A	$I_{REF} = -1\text{ mA}$, See Note 2		15	25	mV
REGIN	Input regulation	$I_{REF} = -1\text{ mA}$, $V_{CC} = 2.5\text{ V to }7\text{ V}$		2	5	mV
REGL	Output regulation	$I_{REF} = -0.1\text{ mA to }-1\text{ mA}$		1	5	mV
I_{OS}	Short-circuit output current	$V_{REF} = 0$	-2	-10	-30	mA

NOTES: 1. Typical values of all parameters except for $V_{REF(dev)}$ and f_{dT} are specified at $T_A = 25^\circ\text{C}$.
2. The deviation parameter $V_{REF(dev)}$ is defined as the difference between the maximum and minimum values obtained over the recommended free-air temperature range (-20°C to 85°C).

undervoltage lockout section

PARAMETER		TEST CONDITIONS	MIN	TYP	MAX	UNIT
V_{TH}	Upper threshold voltage	$T_A = 25^\circ\text{C}$	2.2	2.3	2.4	V
V_{TL}	Lower threshold voltage	$T_A = 25^\circ\text{C}$	2	2.1	2.2	V
V_{hys}	Hysteresis ($V_{TH} - V_{TL}$)	$T_A = 25^\circ\text{C}$	0.1	0.2	0.3	V

NOTE 1: Typical values of all parameters except for $V_{REF(dev)}$ and f_{dT} are specified at $T_A = 25^\circ\text{C}$.

protection control section

PARAMETER		TEST CONDITIONS	MIN	TYP	MAX	UNIT
I_{SCP}	Input terminal source current		-1.4	-2	-2.6	μA
V_{T2}	Input threshold voltage	CH-1, 3	1.10	1.15	1.20	V
V_{T3}		CH-2	0.20	0.25	0.30	
V_R	Latch reset threshold voltage	$T_A = 25^\circ\text{C}$	0.8	1.5		V
V_{T5}	Threshold voltage		1.20	1.25	1.30	V

NOTE 1: Typical values of all parameters except for $V_{REF(dev)}$ and f_{dT} are specified at $T_A = 25^\circ\text{C}$.

oscillator section

PARAMETER		TEST CONDITIONS	MIN	TYP	MAX	UNIT
f_{OSC}	Frequency	$C_T = 130\text{ pF}$, $R_T = 7\text{ k}\Omega$	400	500	600	kHz
f_{dV}	Frequency change with V_{CC}	$V_{CC} = 2.5\text{ V}$, $T_A = 25^\circ\text{C}$, $C_T = 130\text{ pF}$, $R_T = 7\text{ k}\Omega$		1%	2%	
f_{dT}	Frequency change with T_A	$C_T = 130\text{ pF}$, $R_T = 7\text{ k}\Omega$		5%	10%	
$I_{CT/RT}$	Output source current		-180	-200	-220	μA
V_{OSCH}	H level output voltage		0.95	1	1.05	V
V_{OSCL}	L level output voltage		0.35	0.40	0.45	V

NOTE 1: Typical values of all parameters except for $V_{REF(dev)}$ and f_{dT} are specified at $T_A = 25^\circ\text{C}$.

dead time control section

PARAMETER		TEST CONDITIONS	MIN	TYP	MAX	UNIT
$I_{BDT1/3}$	Input bias current	$V_{DTC1/3} = 0.35\text{ V to }1.05\text{ V}$			200	nA
I_{BDT2}		$V_{DTC2} = 0.35\text{ V to }1.05\text{ V}$		± 2	± 20	
V_{T1}	Comparator threshold voltage		0.2	0.25	0.3	V
$V_{T0(DTC1/3)}$	Input threshold voltage (DTC1/3) (see Note 3)	Duty = 0%	0.3	0.4	0.5	V
$V_{T100(DTC1/3)}$		Duty = 100%				
$V_{T0(DTC2)}$	Input threshold voltage (DTC2) (see Note 3)	Duty = 0%	0.3	0.4	0.5	V
$V_{T100(DTC2)}$		Duty = 100%				

NOTES: 1. Typical values of all parameters except for $V_{REF(dev)}$ and f_{dT} are specified at $T_A = 25^\circ\text{C}$.
3. These specifications are not production tested. They are specified as ensured values on circuit design.

TPS5100

TRIPLE-CHANNEL PWM CONTROL CIRCUITS

SLVS169 – JANUARY 2000

electrical characteristics over recommended operating free-air temperature range, $V_{CC} = 3.3\text{ V}$ (unless otherwise noted) (see Note 1) (continued)

error amplifier section

PARAMETER		TEST CONDITIONS		MIN	TYP	MAX	UNIT
V_{IO}	Input offset voltage	CH1, 3,	$A_V = 1$			15	mV
I_{IB}	Input bias current	CH1, 3,	$V_I = -.95\text{ V to }1.55\text{ V}$		± 10	± 20	nA
		CH2,	$V_I = 0.4\text{ V to }1\text{ V}$		± 10	± 20	
V_{IR}	Input voltage range	CH1, 3,		0.95		1.55	V
		CH2		0.4		1	
A_{VD}	Open-loop voltage amplification	$R_{FB} = 200\text{ k}\Omega$			60		dB
B_1	Unity-gain bandwidth				1		MHz
V_{OM+}	Output voltage swing	$V_{ID} = 0.1\text{ V}$	$I_O = 60\text{ }\mu\text{A}$	1.2			V
V_{OM-}			$I_O = 0.2\text{ mA}$	0.2			
I_{OM+}	Output sink current	$V_{ID} = 0.1\text{ V}$,	$V_O = 0.2\text{ V}$	0.2	1		mA
I_{OM-}	Output source current	$V_{ID} = 0.1\text{ V}$,	$V_O = 1.2\text{ V}$	-60	-100		μA
V_{T4}	Input bias voltage	CH2,	$A_V = 1$, $T_A = 25^\circ\text{C}$	678	700	722	mV
		CH2,	$A_V = 1$	665	700	735	

NOTE 1: Typical values of all parameters except for $V_{REF(dev)}$ and f_{dT} are specified at $T_A = 25^\circ\text{C}$.

output section

PARAMETER		TEST CONDITIONS		MIN	TYP	MAX	UNIT
V_{OH}	High-level output voltage	$I_O = 20\text{ mA (CH2)}$		2.9	3.05		V
		$I_O = -40\text{ mA (CH1, 3)}$		1.9	2.2	2.6	
V_{OL}	Low-level output voltage	$I_O = 20\text{ mA (CH1, 3)}$			0.2	0.4	V
		$I_O = 40\text{ mA (CH2)}$		0.2	0.3	0.6	
t_r	Rise time	$CL = 1000\text{ pF}$			130		ns
t_f	Fall time	$I_O = 1000\text{ pF}$			50		ns

NOTE 1: Typical values of all parameters except for $V_{REF(dev)}$ and f_{dT} are specified at $T_A = 25^\circ\text{C}$.

total device

PARAMETER		TEST CONDITIONS		MIN	TYP	MAX	UNIT
I_{CC}	Supply current	Output OFF state			2.5	4	mA
I_{CCA}	Average supply current	$F_{OSC} = 500\text{ kHz}$, Duty = 50%, No load			3.5	5	mA

NOTE 1: Typical values of all parameters except for $V_{REF(dev)}$ and f_{dT} are specified at $T_A = 25^\circ\text{C}$.



TYPICAL CHARACTERISTICS

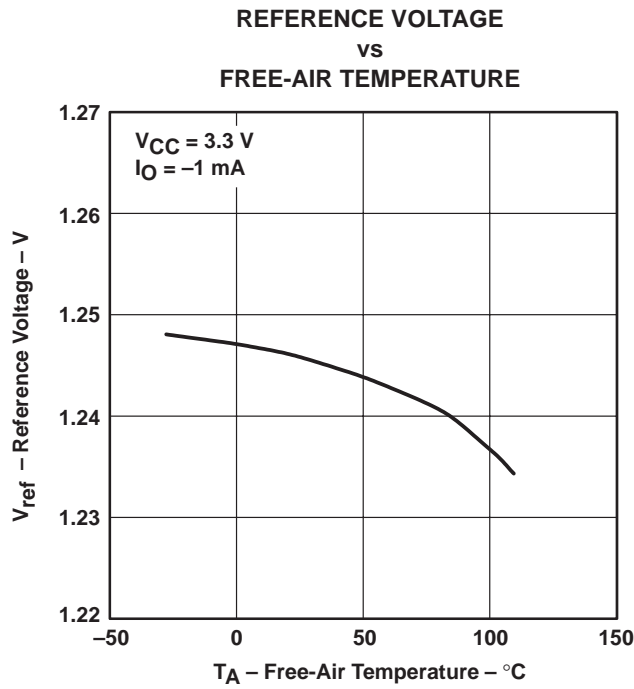

Figure 1

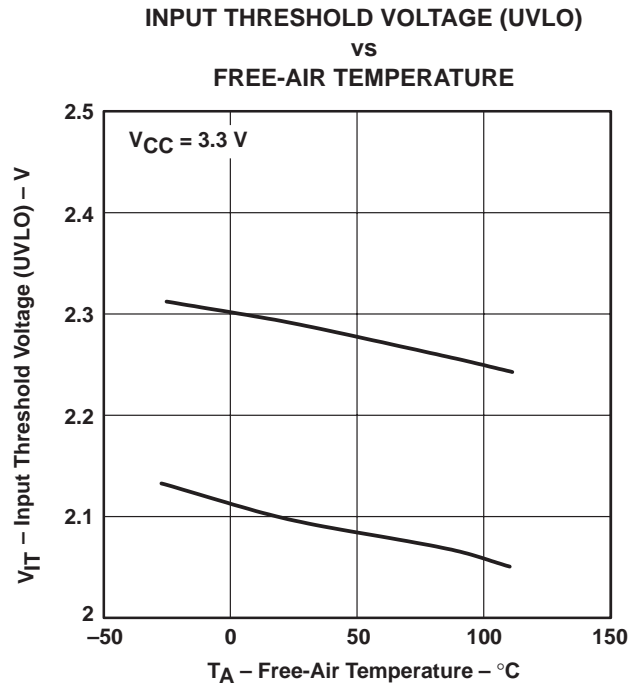

Figure 2

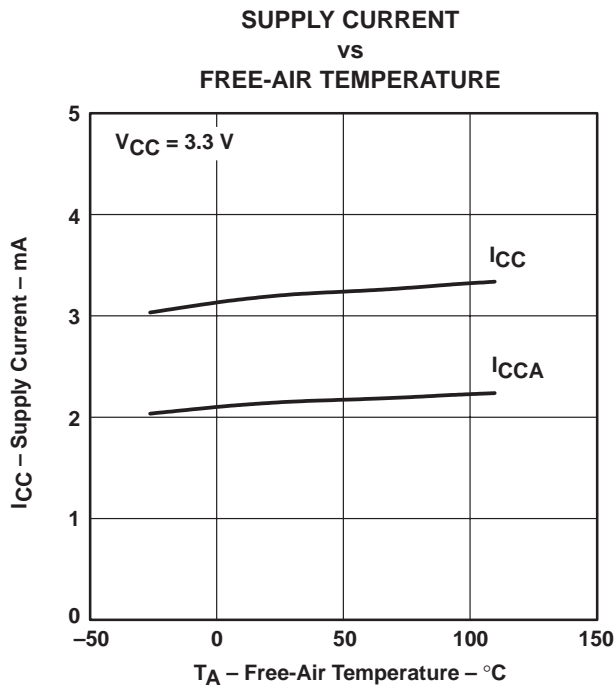

Figure 3

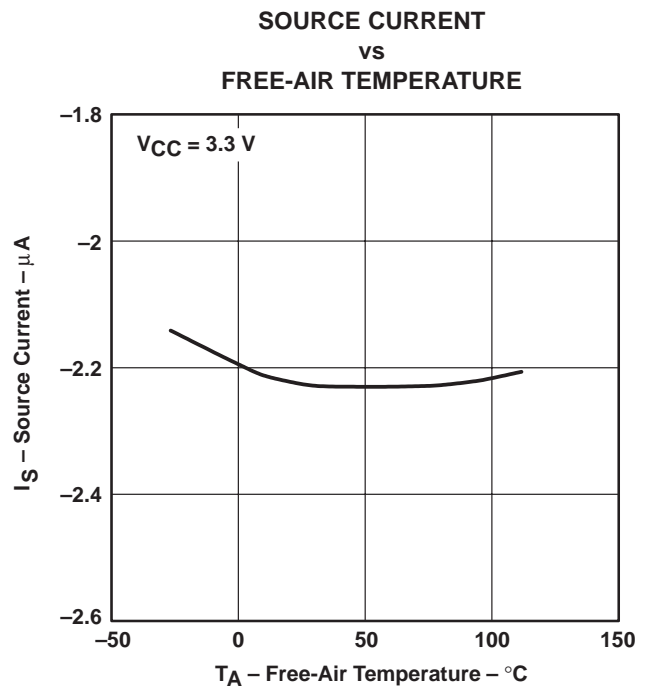

Figure 4

TYPICAL CHARACTERISTICS

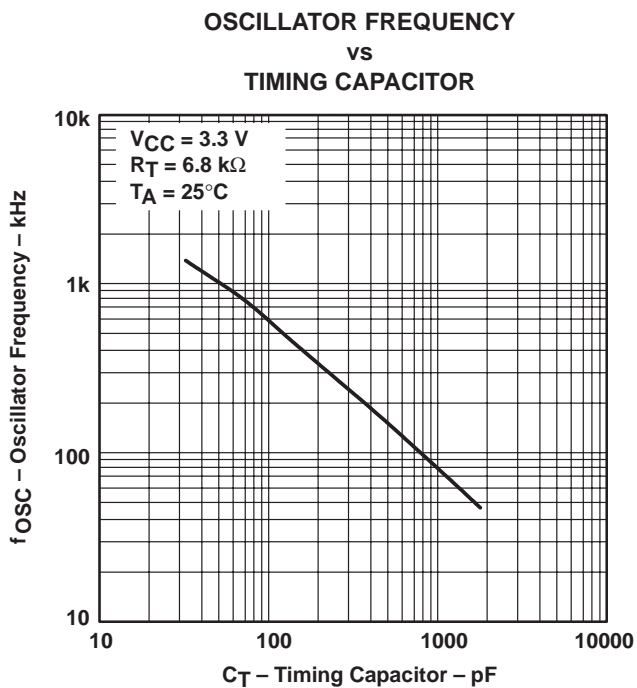

Figure 5

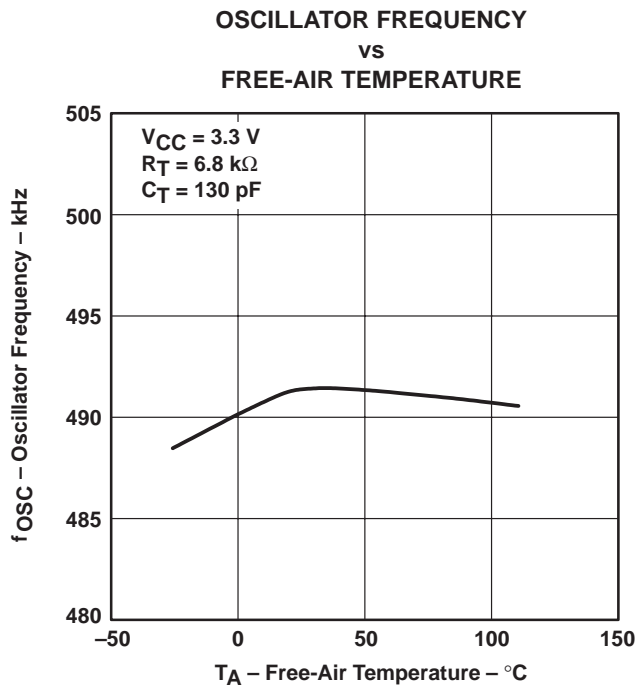

Figure 6

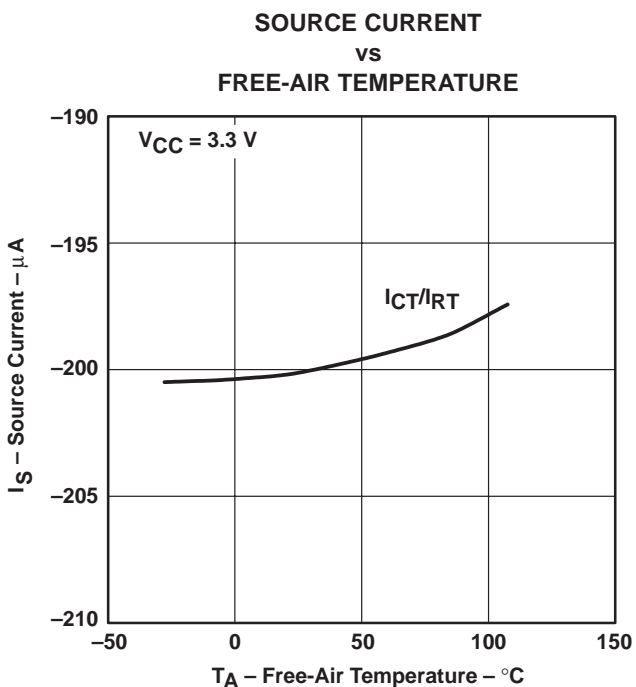
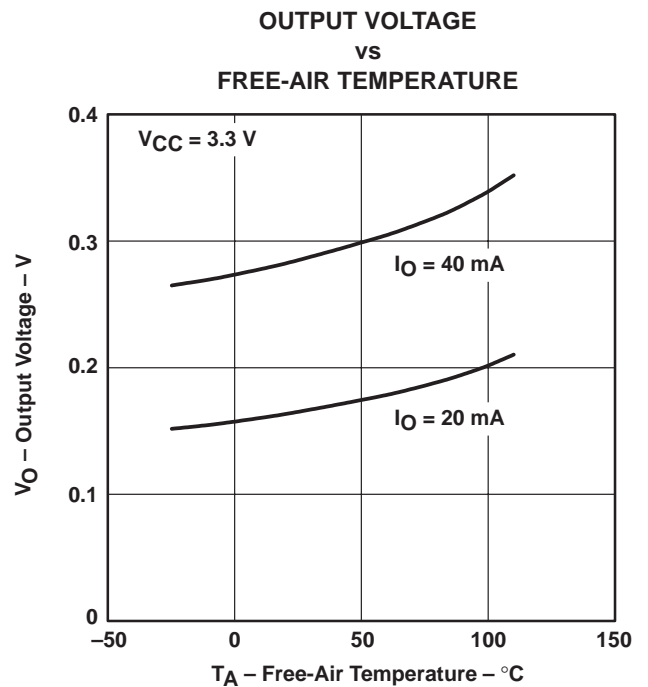
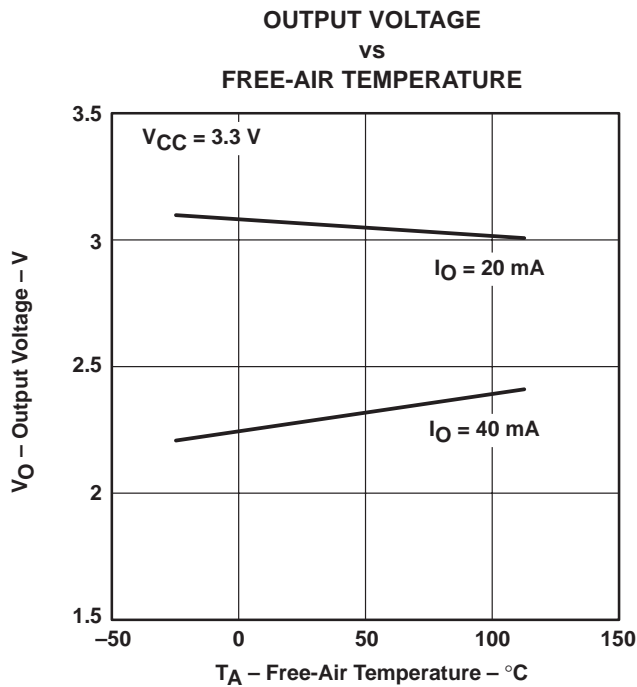
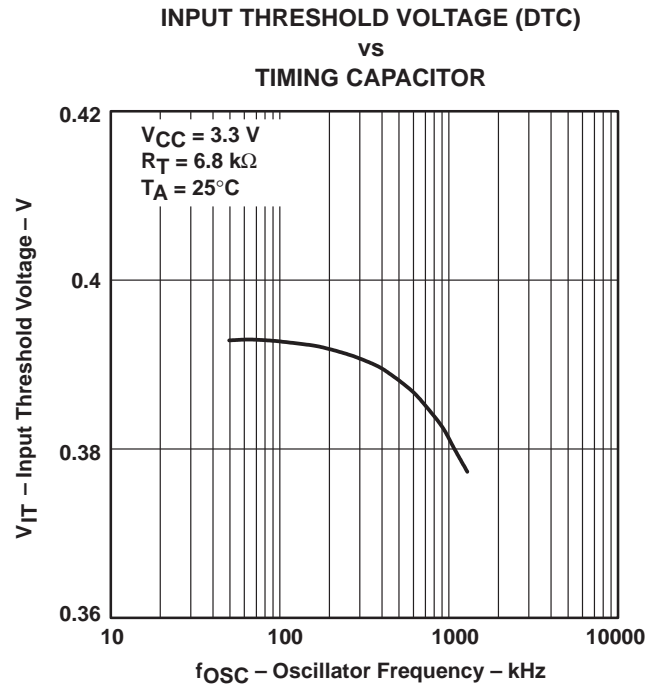
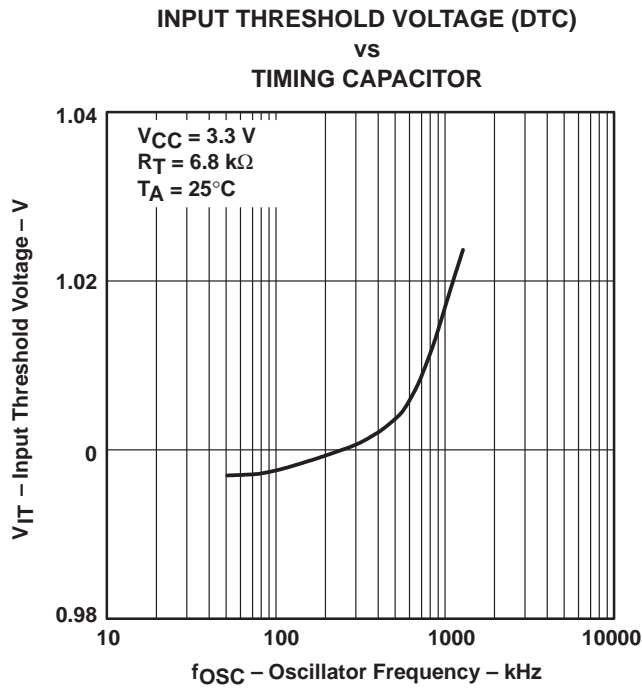

Figure 7

TYPICAL CHARACTERISTICS



TYPICAL CHARACTERISTICS

MAXIMUM PEAK OUTPUT VOLTAGE
vs
OUTPUT SOURCE CURRENT

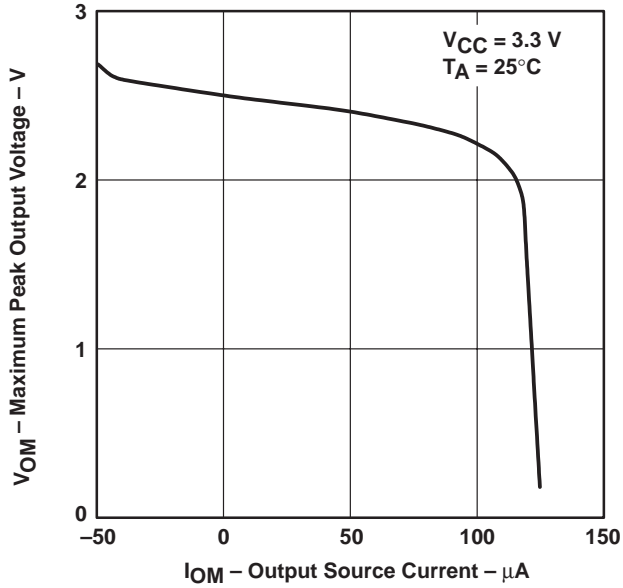

Figure 12

OUTPUT VOLTAGE
vs
SUPPLY VOLTAGE

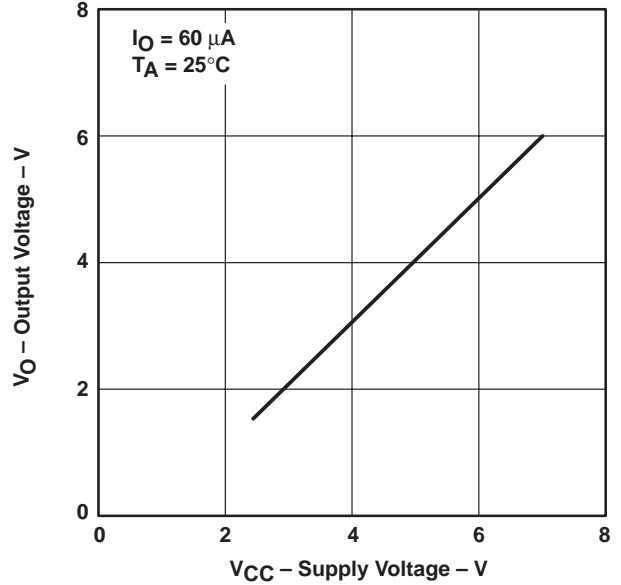

Figure 13

OUTPUT VOLTAGE
vs
OUTPUT CURRENT

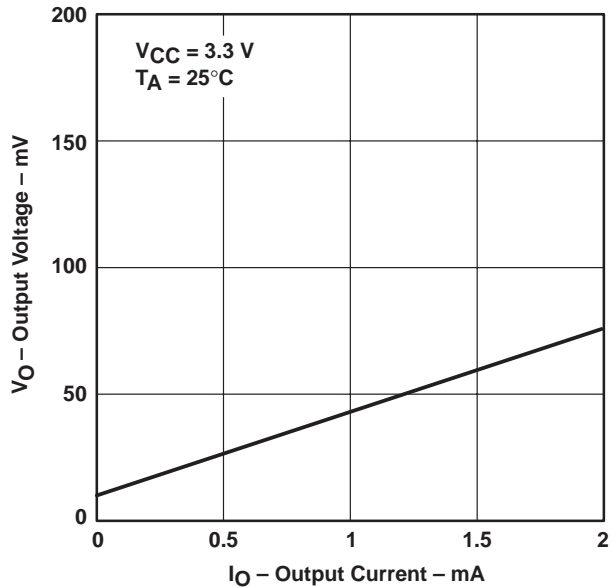

Figure 14

REFERENCE VOLTAGE
vs
SUPPLY VOLTAGE

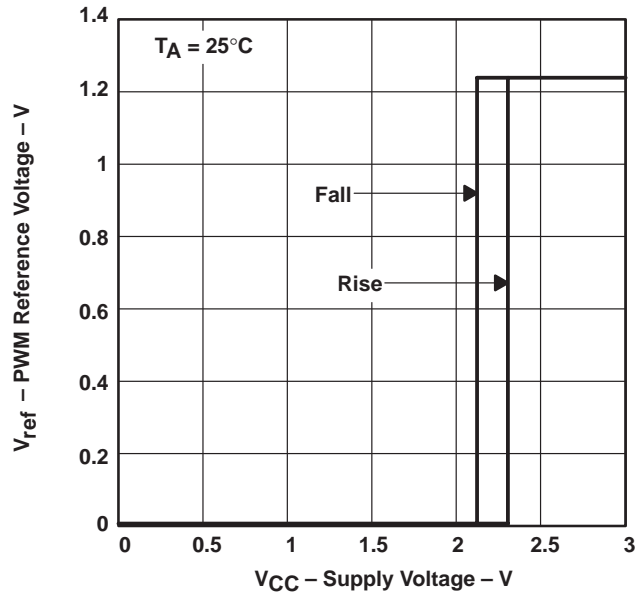

Figure 15

TYPICAL CHARACTERISTICS

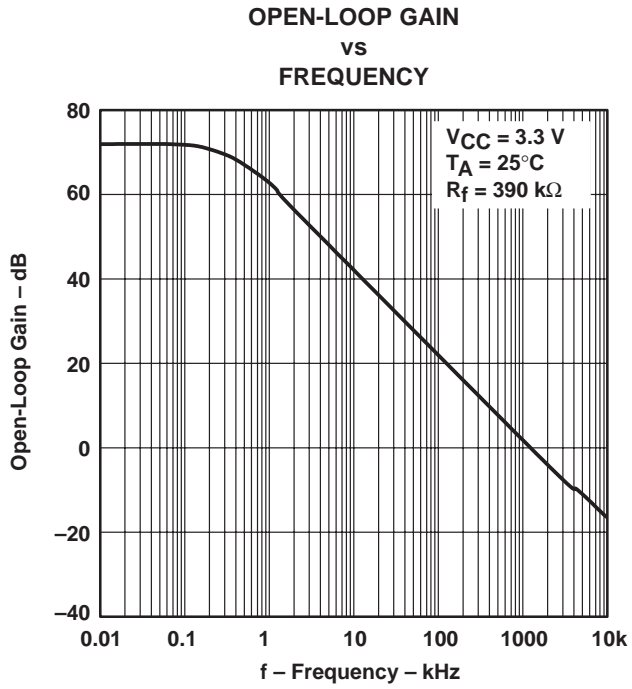

Figure 16

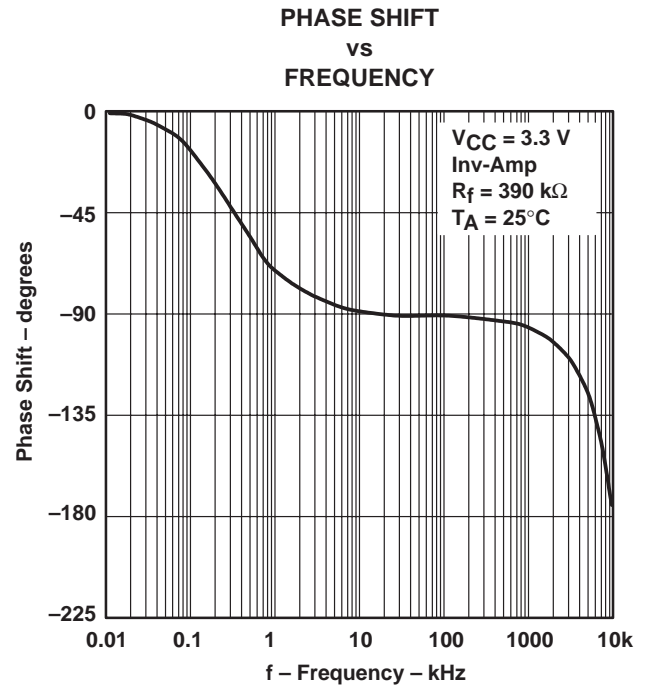

Figure 17

PACKAGING INFORMATION

Orderable part number	Status (1)	Material type (2)	Package Pins	Package qty Carrier	RoHS (3)	Lead finish/ Ball material (4)	MSL rating/ Peak reflow (5)	Op temp (°C)	Part marking (6)
TPS5100IPW	Active	Production	TSSOP (PW) 16	90 TUBE	Yes	NIPDAU	Level-1-260C-UNLIM	-40 to 85	PU5100
TPS5100IPW.A	Active	Production	TSSOP (PW) 16	90 TUBE	Yes	NIPDAU	Level-1-260C-UNLIM	-40 to 85	PU5100

(1) **Status:** For more details on status, see our [product life cycle](#).

(2) **Material type:** When designated, preproduction parts are prototypes/experimental devices, and are not yet approved or released for full production. Testing and final process, including without limitation quality assurance, reliability performance testing, and/or process qualification, may not yet be complete, and this item is subject to further changes or possible discontinuation. If available for ordering, purchases will be subject to an additional waiver at checkout, and are intended for early internal evaluation purposes only. These items are sold without warranties of any kind.

(3) **RoHS values:** Yes, No, RoHS Exempt. See the [TI RoHS Statement](#) for additional information and value definition.

(4) **Lead finish/Ball material:** Parts may have multiple material finish options. Finish options are separated by a vertical ruled line. Lead finish/Ball material values may wrap to two lines if the finish value exceeds the maximum column width.

(5) **MSL rating/Peak reflow:** The moisture sensitivity level ratings and peak solder (reflow) temperatures. In the event that a part has multiple moisture sensitivity ratings, only the lowest level per JEDEC standards is shown. Refer to the shipping label for the actual reflow temperature that will be used to mount the part to the printed circuit board.

(6) **Part marking:** There may be an additional marking, which relates to the logo, the lot trace code information, or the environmental category of the part.

Multiple part markings will be inside parentheses. Only one part marking contained in parentheses and separated by a "~" will appear on a part. If a line is indented then it is a continuation of the previous line and the two combined represent the entire part marking for that device.

Important Information and Disclaimer:The information provided on this page represents TI's knowledge and belief as of the date that it is provided. TI bases its knowledge and belief on information provided by third parties, and makes no representation or warranty as to the accuracy of such information. Efforts are underway to better integrate information from third parties. TI has taken and continues to take reasonable steps to provide representative and accurate information but may not have conducted destructive testing or chemical analysis on incoming materials and chemicals. TI and TI suppliers consider certain information to be proprietary, and thus CAS numbers and other limited information may not be available for release.

In no event shall TI's liability arising out of such information exceed the total purchase price of the TI part(s) at issue in this document sold by TI to Customer on an annual basis.

TUBE

*All dimensions are nominal

Device	Package Name	Package Type	Pins	SPQ	L (mm)	W (mm)	T (μm)	B (mm)
TPS5100IPW	PW	TSSOP	16	90	530	10.2	3600	3.5
TPS5100IPW.A	PW	TSSOP	16	90	530	10.2	3600	3.5



4220204/B 12/2023

NOTES:

1. All linear dimensions are in millimeters. Any dimensions in parenthesis are for reference only. Dimensioning and tolerancing per ASME Y14.5M.
2. This drawing is subject to change without notice.
3. This dimension does not include mold flash, protrusions, or gate burrs. Mold flash, protrusions, or gate burrs shall not exceed 0.15 mm per side.
4. This dimension does not include interlead flash. Interlead flash shall not exceed 0.25 mm per side.
5. Reference JEDEC registration MO-153.

EXAMPLE BOARD LAYOUT

PW0016A

TSSOP - 1.2 mm max height

SMALL OUTLINE PACKAGE



LAND PATTERN EXAMPLE
EXPOSED METAL SHOWN
SCALE: 10X



SOLDER MASK DETAILS

4220204/B 12/2023

NOTES: (continued)

6. Publication IPC-7351 may have alternate designs.
7. Solder mask tolerances between and around signal pads can vary based on board fabrication site.

EXAMPLE STENCIL DESIGN

PW0016A

TSSOP - 1.2 mm max height

SMALL OUTLINE PACKAGE



SOLDER PASTE EXAMPLE
BASED ON 0.125 mm THICK STENCIL
SCALE: 10X

4220204/B 12/2023

NOTES: (continued)

8. Laser cutting apertures with trapezoidal walls and rounded corners may offer better paste release. IPC-7525 may have alternate design recommendations.
9. Board assembly site may have different recommendations for stencil design.

IMPORTANT NOTICE AND DISCLAIMER

TI PROVIDES TECHNICAL AND RELIABILITY DATA (INCLUDING DATASHEETS), DESIGN RESOURCES (INCLUDING REFERENCE DESIGNS), APPLICATION OR OTHER DESIGN ADVICE, WEB TOOLS, SAFETY INFORMATION, AND OTHER RESOURCES "AS IS" AND WITH ALL FAULTS, AND DISCLAIMS ALL WARRANTIES, EXPRESS AND IMPLIED, INCLUDING WITHOUT LIMITATION ANY IMPLIED WARRANTIES OF MERCHANTABILITY, FITNESS FOR A PARTICULAR PURPOSE OR NON-INFRINGEMENT OF THIRD PARTY INTELLECTUAL PROPERTY RIGHTS.

These resources are intended for skilled developers designing with TI products. You are solely responsible for (1) selecting the appropriate TI products for your application, (2) designing, validating and testing your application, and (3) ensuring your application meets applicable standards, and any other safety, security, regulatory or other requirements.

These resources are subject to change without notice. TI grants you permission to use these resources only for development of an application that uses the TI products described in the resource. Other reproduction and display of these resources is prohibited. No license is granted to any other TI intellectual property right or to any third party intellectual property right. TI disclaims responsibility for, and you fully indemnify TI and its representatives against any claims, damages, costs, losses, and liabilities arising out of your use of these resources.

TI's products are provided subject to [TI's Terms of Sale](#), [TI's General Quality Guidelines](#), or other applicable terms available either on ti.com or provided in conjunction with such TI products. TI's provision of these resources does not expand or otherwise alter TI's applicable warranties or warranty disclaimers for TI products. Unless TI explicitly designates a product as custom or customer-specified, TI products are standard, catalog, general purpose devices.

TI objects to and rejects any additional or different terms you may propose.

Copyright © 2025, Texas Instruments Incorporated

Last updated 10/2025