

# Why Should You Care about the Noise Immunity of MLVDS Drivers and Receivers?



Nic Lin

Noise immunity is the ability of a device or system to suppress external noise, and to function – without deteriorating in performance – in the presence of noise. Multipoint low-voltage differential (MLVDS) devices are used widely in wired communication, optical communication and backplane applications, which are often located in harsh and noisy environments. To increase the robustness of MLVDS devices requires a high level of noise immunity performance.

## How Is Noise Immunity Measured?

Noise immunity is measured by connecting an MLVDS driver to an MLVDS receiver in point-to-point mode and measuring the noise power in decibel-milliwatts over a frequency range. Figure 1 shows a noise immunity measurement test setup with TI's SN65MLVD206B and SN65MLVD206B transceivers connected in a point-to-point topology. Note the 100Ω termination resistor placed between the LVDS bus. A coupling network with a 120Ω resistor and 4.7nF capacitor is used for common-mode (CM) noise injection. A clock signal input to the driver measures the impact of injected CM noise. After injecting CM noise into the LVDS bus through the resistor-capacitor (RC) coupling network, you can measure the subsequent output jitter. The measured output jitter over frequency translates to the noise immunity in decibel-milliwatts, as shown in Figure 2.

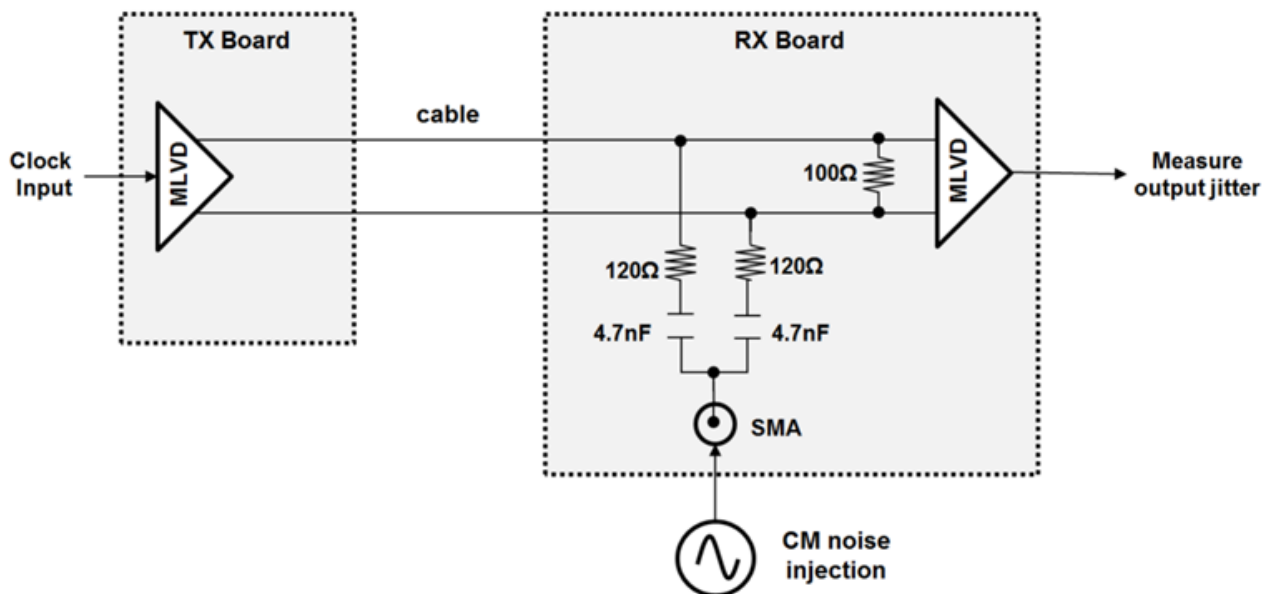
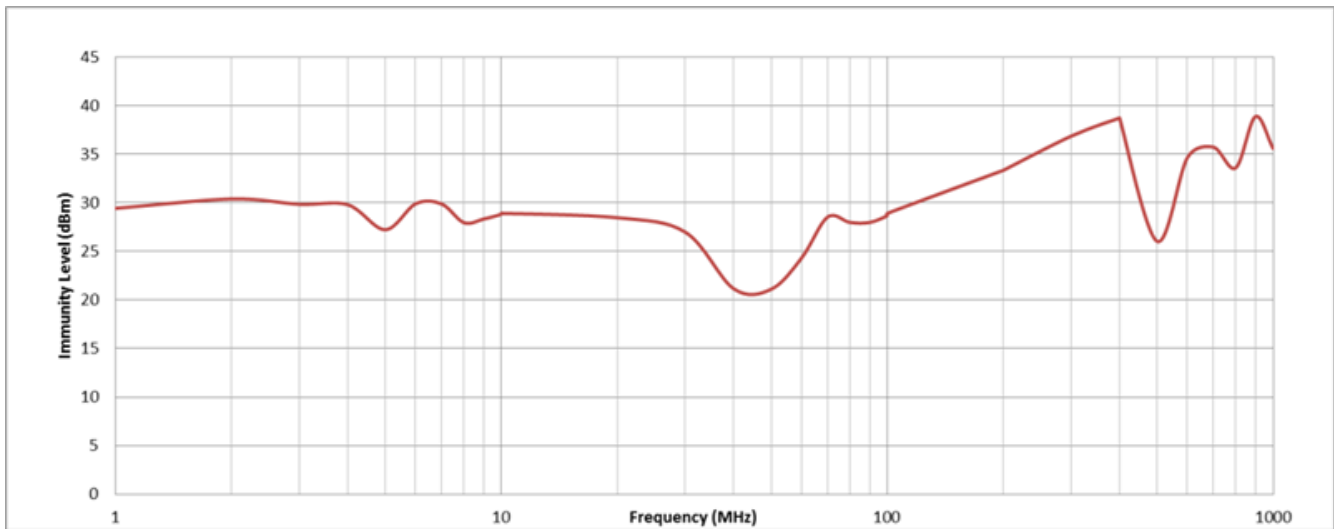
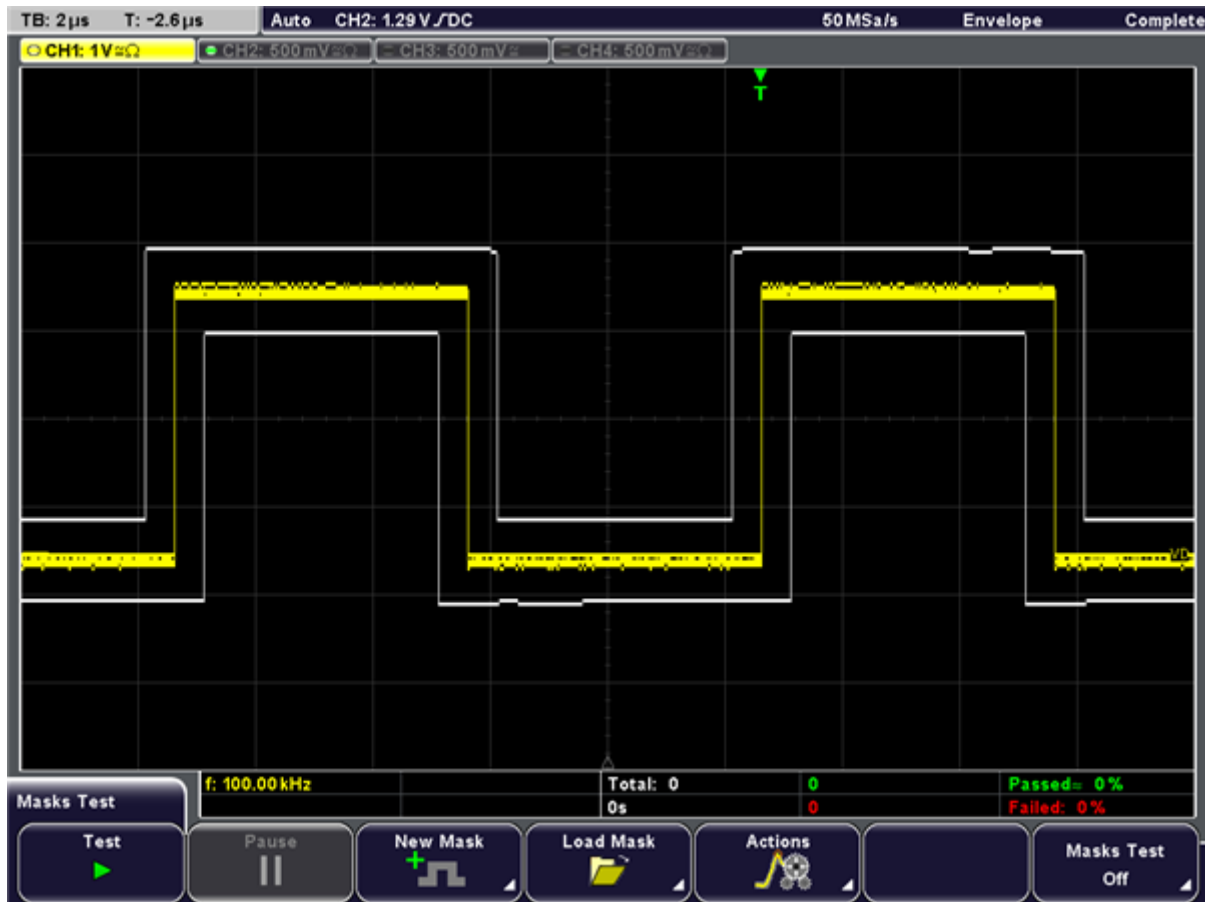

Figure 1. Noise Immunity Test Setup



**Figure 2. Noise Immunity Level over Frequency**

A noise immunity test is based on a mask test. As [Figure 3](#) shows, the yellow waveform is the output signal of an MLVDS receiver without noise injected. The white mask indicates the 0.2 unit interval (UI) jitter limit. For a given noise frequency, the mask test starts with the maximum injected noise power, which you set manually. If the output jitter violates the mask, the injected noise power decreases in large steps until the output jitter no longer violates the mask limits. The injected noise power then increases in small steps until a violation occurs. The noise immunity level for this frequency is the maximum injected noise power that does not violate the output jitter mask.



**Figure 3. Noise Immunity Mask Test without Noise Injection**

## Why Is Noise Immunity Important?

Figure 4 shows several MLVDS receiver output signals impacted by injected noise. As you can see, the higher the noise power, the worse the signal.

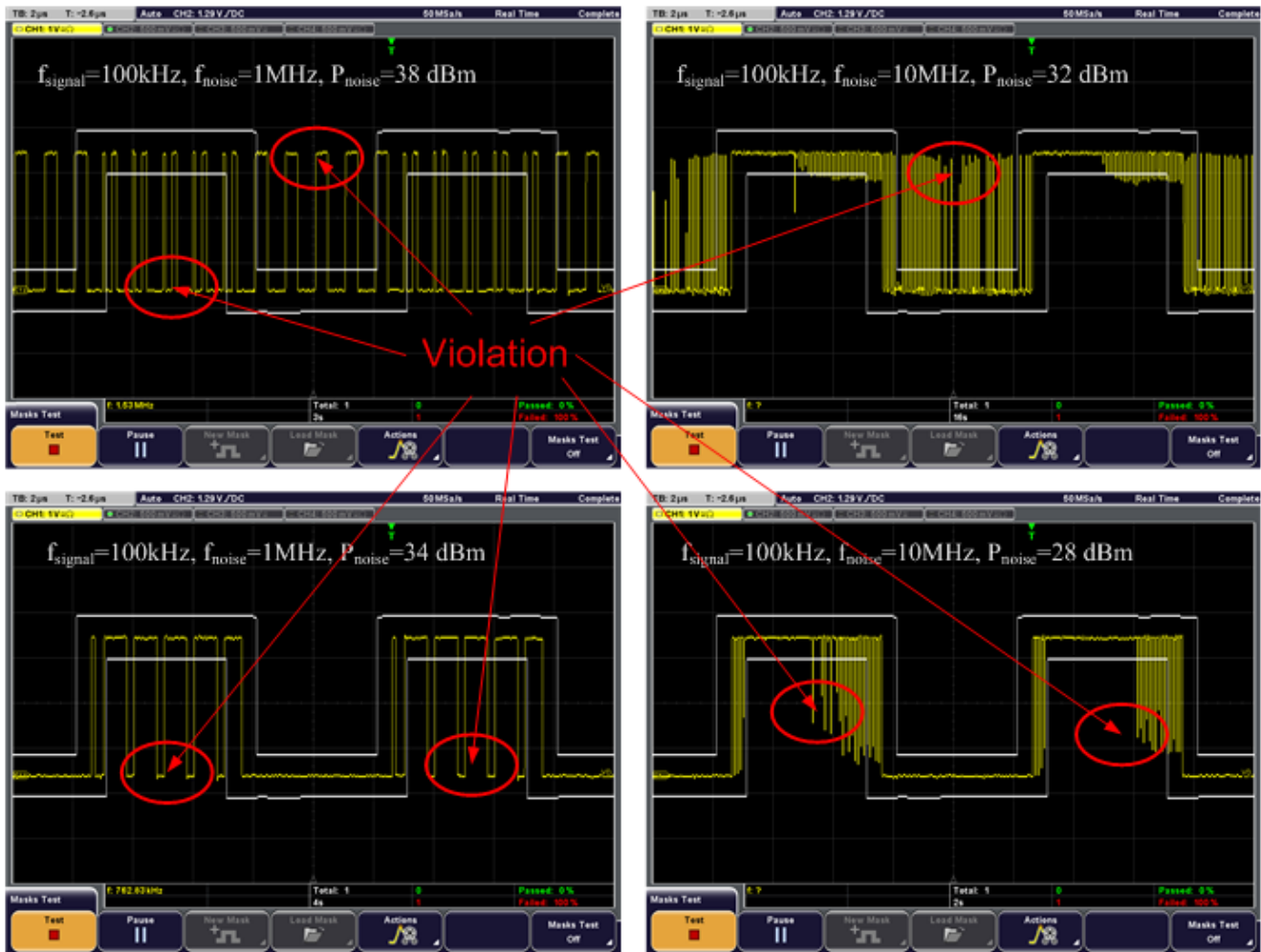

**Figure 4. Noise Immunity Mask Test with Noise Injection (Mask Violation)**

If the injected noise power exceeds the noise immunity level for a specified noise frequency, the excessive jitter will violate the mask. But if the injected noise power is lower than the noise immunity level, the MLVDS receiver will act normally and the output signal will not violate the mask, as shown in Figure 5. So the higher the noise immunity level, the more robust the device.

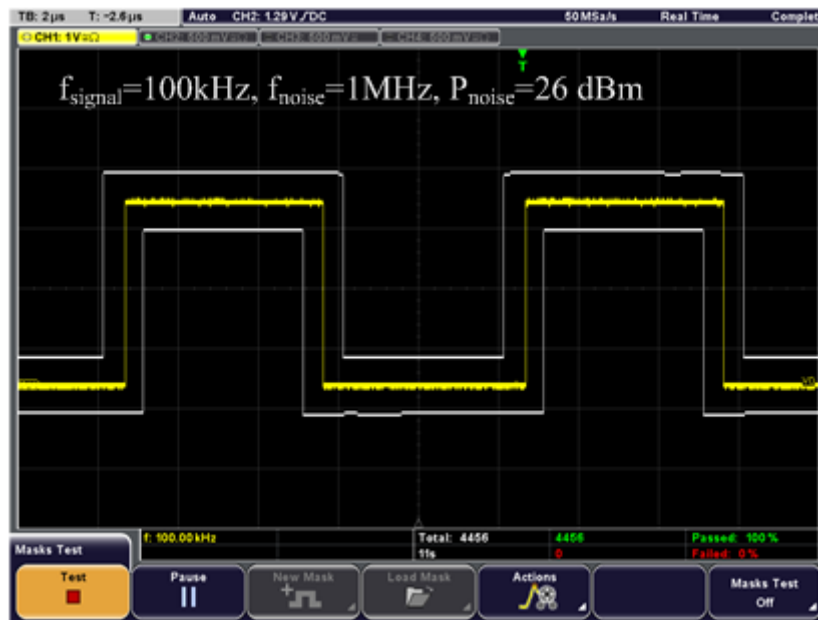

**Figure 5. Noise Immunity Mask Test with Noise Injection (Mask Nonviolation)**

Noise will degrade MLVDS signals and negatively impact the performance of the whole system. Noise is pervasive in any application system. The noise source depends on the environment around the network. It may originate from noisy power supplies, high-current machinery, radio-frequency coupling, accidental electrostatic discharge (ESD) transients or other sources.

One commonly overlooked noise source is ESD transients that occur elsewhere in the system but translate into a noise source for MLVDS devices. MLVDS devices with higher noise immunity can suppress external noise more effectively, including ESD noise.

### TI Noise Immunity Performance vs. Competitors

Figure 6 and Figure 7 compare the noise immunity performance of TI's SN65MLVD204B and SN65MLVD206B MLVDS transceivers vs. competing devices, respectively. The input clock for all noise immunity measurements is 25MHz. As the figures show, TI's MLVDS solutions have higher noise immunity than its competitors and offer better stability against external noise sources, including ESD transients.

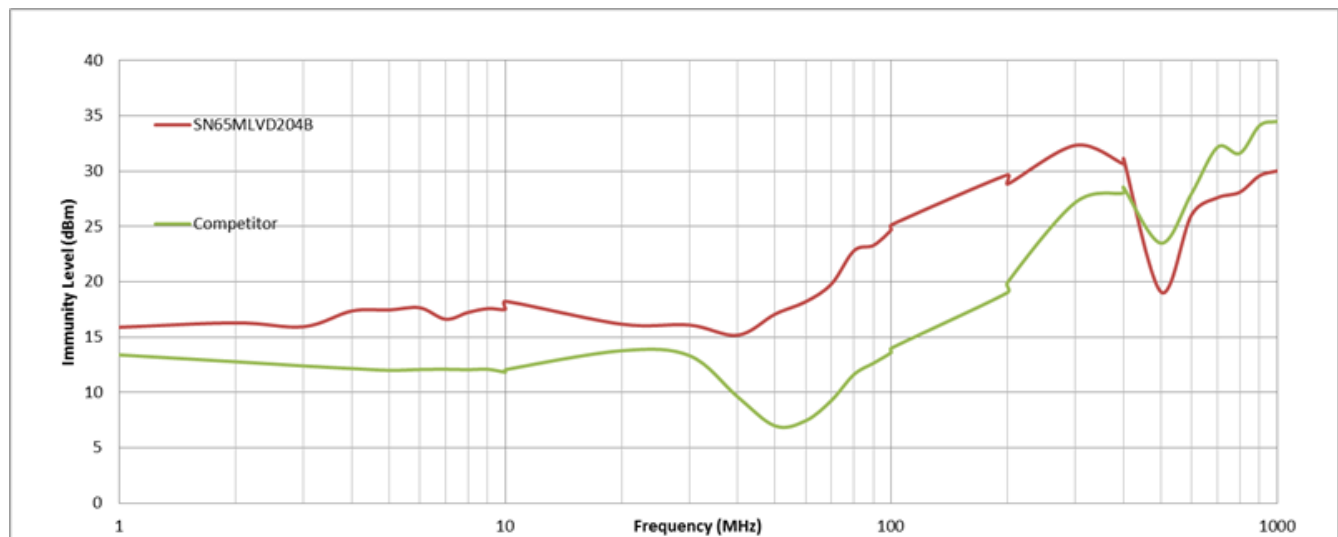

**Figure 6. TI's SN65MLVD204B vs. Competing Devices**

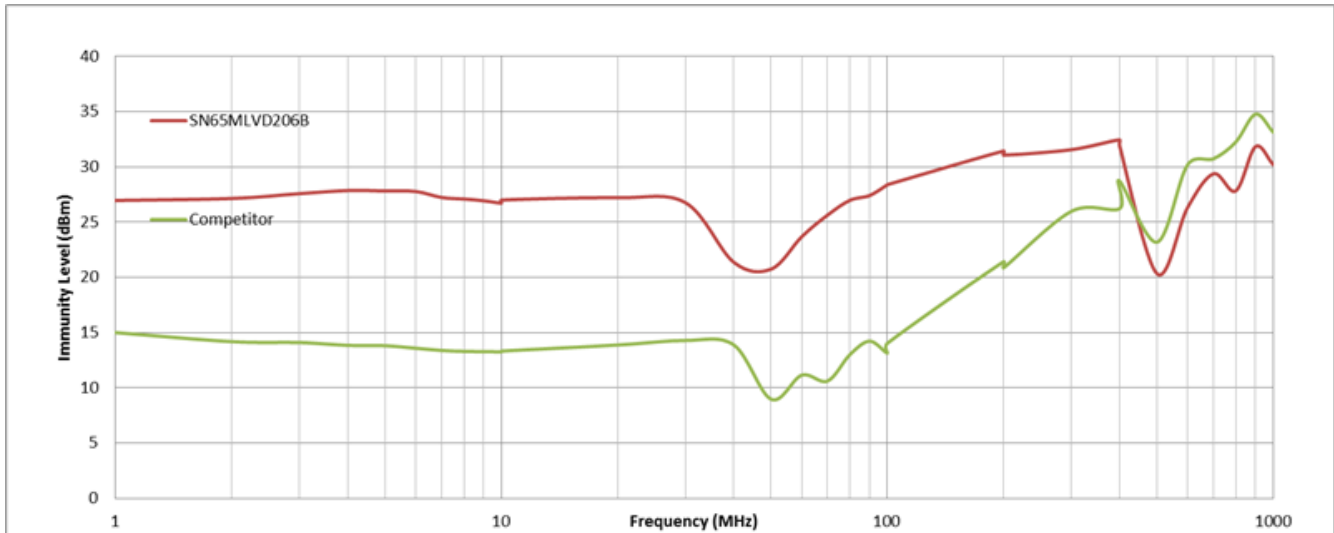

**Figure 7. TI's SN65MLVD206B vs. Competing Devices**

In conclusion, higher noise immunity of MLVDS devices means being able to suppress more noise in wired communication, optical communication and backplane applications, which makes sure that they are working properly.

For more information about the SN65MLVDS204B, SN65MLVDS206B and other TI MLVDS solutions, see [www.ti.com/lvds](http://www.ti.com/lvds) or our [TI E2E™ forum](#).

## IMPORTANT NOTICE AND DISCLAIMER

TI PROVIDES TECHNICAL AND RELIABILITY DATA (INCLUDING DATA SHEETS), DESIGN RESOURCES (INCLUDING REFERENCE DESIGNS), APPLICATION OR OTHER DESIGN ADVICE, WEB TOOLS, SAFETY INFORMATION, AND OTHER RESOURCES "AS IS" AND WITH ALL FAULTS, AND DISCLAIMS ALL WARRANTIES, EXPRESS AND IMPLIED, INCLUDING WITHOUT LIMITATION ANY IMPLIED WARRANTIES OF MERCHANTABILITY, FITNESS FOR A PARTICULAR PURPOSE OR NON-INFRINGEMENT OF THIRD PARTY INTELLECTUAL PROPERTY RIGHTS.

These resources are intended for skilled developers designing with TI products. You are solely responsible for (1) selecting the appropriate TI products for your application, (2) designing, validating and testing your application, and (3) ensuring your application meets applicable standards, and any other safety, security, regulatory or other requirements.

These resources are subject to change without notice. TI grants you permission to use these resources only for development of an application that uses the TI products described in the resource. Other reproduction and display of these resources is prohibited. No license is granted to any other TI intellectual property right or to any third party intellectual property right. TI disclaims responsibility for, and you will fully indemnify TI and its representatives against, any claims, damages, costs, losses, and liabilities arising out of your use of these resources.

TI's products are provided subject to [TI's Terms of Sale](#) or other applicable terms available either on [ti.com](https://www.ti.com) or provided in conjunction with such TI products. TI's provision of these resources does not expand or otherwise alter TI's applicable warranties or warranty disclaimers for TI products.

TI objects to and rejects any additional or different terms you may have proposed.

Mailing Address: Texas Instruments, Post Office Box 655303, Dallas, Texas 75265  
Copyright © 2023, Texas Instruments Incorporated