

AMC1306M25E High-Precision, Reinforced Isolated Delta-Sigma Modulator With -55°C Extended Temperature Range

1 Features

- Linear input voltage range: $\pm 250\text{ mV}$
- Low DC errors:
 - Offset error: $\pm 100\ \mu\text{V}$ (max)
 - Offset drift: $1\ \mu\text{V}/^{\circ}\text{C}$ (max)
 - Gain error: $\pm 0.2\%$ (max)
 - Gain drift: $\pm 40\ \text{ppm}/^{\circ}\text{C}$ (max)
- High CMTI: $100\ \text{kV}/\mu\text{s}$ (min)
- Low EMI: Meets CISPR-11 and CISPR-25 standards
- Safety-related certifications:
 - $7070\text{-}V_{\text{PEAK}}$ reinforced isolation per DIN EN IEC 60747-17 (VDE 0884-17): 2021-10
 - $5000\text{-}V_{\text{RMS}}$ isolation for 1 minute per UL1577
- Fully specified over the extended industrial temperature range: -40°C to $+125^{\circ}\text{C}$
- Supports operation down to -55°C

2 Applications

- Shunt-resistor-based current sensing and isolated voltage measurements in:
 - [Traction inverters](#)
 - [Onboard chargers](#)
 - [DC/DC converters](#)
 - [HEV/EV DC chargers](#)

3 Description

The AMC1306M25E is a precision, delta-sigma ($\Delta\Sigma$) modulator with the output separated from the input circuitry by an isolation barrier that is highly resistant to magnetic interference. This barrier is certified to provide reinforced isolation of up to $7070\ V_{\text{PEAK}}$ according to the DIN EN IEC 60747-17 (VDE 0884-17) and UL1577 standards, and supports a working voltage up to $1.5\ \text{kV}_{\text{RMS}}$. The isolation barrier separates parts of the system that operate on different common-mode voltage levels and protects the low-voltage side from voltages that can cause electrical damage or be harmful to an operator.

The input of the AMC1306M25E is optimized for direct connection to shunt resistors or other low voltage-level signal sources. The excellent DC accuracy and low temperature drift supports accurate current control in onboard chargers (OBC), DC/DC converters, traction inverters, or other high-voltage applications. By using an integrated digital filter (such as those in the [TMS320F2807x](#) or [TMS320F2837x](#) microcontroller families) to decimate the bitstream, the device can achieve 16 bits of resolution with a dynamic range of 85 dB at a data rate of 78 kSPS.

The AMC1306M25E is offered in a 8-pin, wide-body SOIC package, is fully specified over the extended industrial temperature range of -40°C to $+125^{\circ}\text{C}$, and supports operation down to -55°C .

Package Information

PART NUMBER	PACKAGE ⁽¹⁾	BODY SIZE (NOM)
AMC1306M25E	DWV (SOIC, 8)	5.85 mm × 7.50 mm

(1) For all available packages, see the orderable addendum at the end of the data sheet.

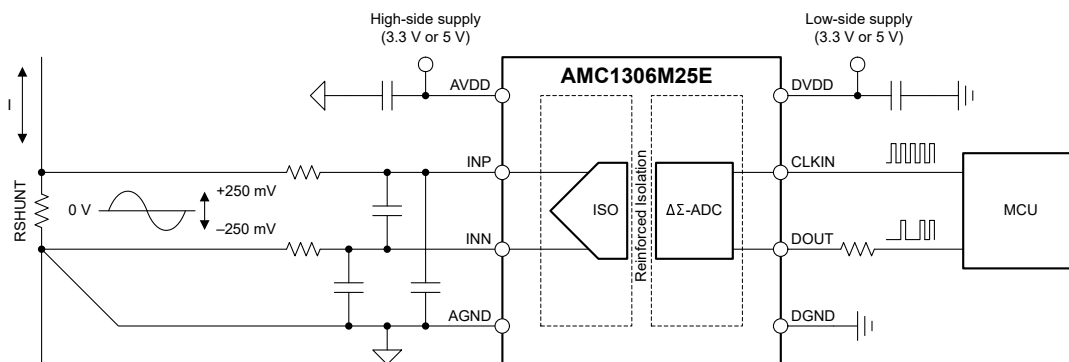

Typical Application



Table of Contents

1 Features	1	7.1 Overview.....	18
2 Applications	1	7.2 Functional Block Diagram.....	18
3 Description	1	7.3 Feature Description.....	19
4 Revision History	2	7.4 Device Functional Modes.....	22
5 Pin Configuration and Functions	3	8 Application and Implementation	23
6 Specifications	4	8.1 Application Information.....	23
6.1 Absolute Maximum Ratings.....	4	8.2 Typical Application.....	23
6.2 ESD Ratings.....	4	8.3 Best Design Practices.....	26
6.3 Recommended Operating Conditions.....	4	8.4 Power Supply Recommendations.....	26
6.4 Thermal Information.....	5	8.5 Layout.....	27
6.5 Power Ratings.....	5	9 Device and Documentation Support	28
6.6 Insulation Specifications.....	6	9.1 Documentation Support.....	28
6.7 Safety-Related Certifications.....	7	9.2 Receiving Notification of Documentation Updates.....	28
6.8 Safety Limiting Values.....	7	9.3 Support Resources.....	28
6.9 Electrical Characteristics.....	8	9.4 Trademarks.....	28
6.10 Switching Characteristics.....	10	9.5 Electrostatic Discharge Caution.....	28
6.11 Timing Diagrams.....	10	9.6 Glossary.....	28
6.12 Insulation Characteristics Curves.....	11	10 Mechanical, Packaging, and Orderable Information	28
6.13 Typical Characteristics.....	12		
7 Detailed Description	18		

4 Revision History

NOTE: Page numbers for previous revisions may differ from page numbers in the current version.

DATE	REVISION	NOTES
March 2023	*	Initial Release

5 Pin Configuration and Functions

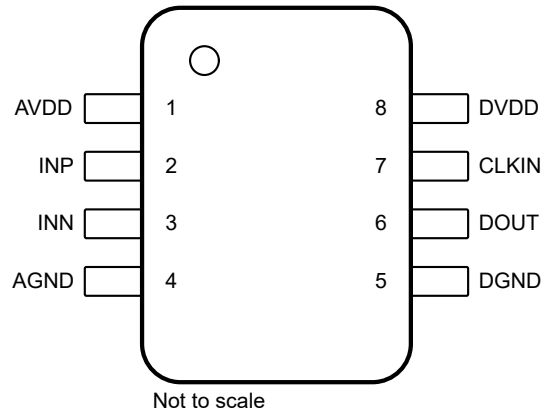

Figure 5-1. DWV Package, 8-Pin SOIC (Top View)

Table 5-1. Pin Functions

PIN		TYPE	DESCRIPTION
NO.	NAME		
1	AVDD	High-side power	Analog (high-side) power supply ⁽¹⁾
2	INP	Analog input	Noninverting analog input
3	INN	Analog input	Inverting analog input
4	AGND	High-side ground	Analog (high-side) ground reference
5	DGND	Low-side ground	Digital (low-side) ground reference
6	DOUT	Digital output	Modulator data output
7	CLKIN	Digital input	Modulator clock input with internal pulldown resistor (typical value: 1.5 MΩ)
8	DVDD	Low-side power	Digital (low-side) power supply ⁽¹⁾

(1) See the [Power Supply Recommendations](#) section for power-supply decoupling recommendations.

6 Specifications

6.1 Absolute Maximum Ratings

see⁽¹⁾

PARAMETER		MIN	MAX	UNIT
Power-supply voltage	AVDD to AGND	-0.3	6.5	V
	DVDD to DGND	-0.3	6.5	
Analog input voltage	INP, INN	AGND - 6	AVDD + 0.5V	V
Digital input voltage	CLKIN	DGND - 0.5	DVDD + 0.5	V
Digital output voltage	DOUT	DGND - 0.5	DVDD + 0.5	V
Input current	Continuous, any pin except power-supply pins	-10	10	mA
Temperature	Junction, T _J		150	°C
	Storage, T _{stg}	-65	150	

- (1) Operation outside the *Absolute Maximum Ratings* may cause permanent device damage. *Absolute Maximum Ratings* do not imply functional operation of the device at these or any other conditions beyond those listed under *Recommended Operating Conditions*. If used outside the Recommended Operating Conditions but within the Absolute Maximum Ratings, the device may not be fully functional, and this may affect device reliability, functionality, performance, and shorten the device lifetime.

6.2 ESD Ratings

			VALUE	UNIT
V _(ESD)	Electrostatic discharge	Human-body model (HBM), per ANSI/ESDA/JEDEC JS-001 ⁽¹⁾	±2000	V
		Charged-device model (CDM), per per ANSI/ESDA/JEDEC JS-002 ⁽²⁾	±1000	

- (1) JEDEC document JEP155 states that 500-V HBM allows safe manufacturing with a standard ESD control process.
 (2) JEDEC document JEP157 states that 250-V CDM allows safe manufacturing with a standard ESD control process.

6.3 Recommended Operating Conditions

over operating ambient temperature range (unless otherwise noted)

				MIN	NOM	MAX	UNIT
POWER SUPPLY							
AVDD	Hgh-side power supply	AVDD to AGND		3	5.0	5.5	V
DVDD	Low-side power supply	DVDD to DGND		2.7	3.3	5.5	V
ANALOG INPUT							
V _{Clipping}	Differential input voltage before clipping output	V _{IN} = V _{INP} - V _{INN}			±320		mV
V _{F_{SR}}	Specified linear differential full-scale voltage	V _{IN} = V _{INP} - V _{INN}		-250		250	mV
V _{CM}	Operating common-mode input voltage	(V _{INP} + V _{INN}) / 2 to AGND		-0.16		AVDD - 2.1	V
DIGITAL I/O							
V _{IO}	Digital input/output voltage			0		VDD	V
f _{CLKIN}	Input clock frequency, -55°C ≤ T _A ≤ 125°C	4.5 V ≤ AVDD ≤ 5.5 V		5	20	21	MHz
		3.0 V ≤ AVDD ≤ 5.5 V		5	20	20	
t _{HIGH}	Input clock high time, -55°C ≤ T _A ≤ 125°C			20	25	120	ns
t _{LOW}	Input clock low time, -55°C ≤ T _A ≤ 125°C			20	25	120	ns
TEMPERATURE RANGE							
T _A	Specified ambient temperature			-40		125	°C
	Operating ambient temperature			-55		125	

6.4 Thermal Information

THERMAL METRIC ⁽¹⁾		DWV (SOIC)	UNIT
		8 PINS	
R _{θJA}	Junction-to-ambient thermal resistance	112.2	°C/W
R _{θJC(top)}	Junction-to-case (top) thermal resistance	47.6	°C/W
R _{θJB}	Junction-to-board thermal resistance	60.0	°C/W
Ψ _{JT}	Junction-to-top characterization parameter	23.1	°C/W
Ψ _{JB}	Junction-to-board characterization parameter	60.0	°C/W
R _{θJC(bot)}	Junction-to-case (bottom) thermal resistance	N/A	°C/W

(1) For more information about traditional and new thermal metrics, see the [Semiconductor and IC Package Thermal Metrics](#) application report.

6.5 Power Ratings

PARAMETER		TEST CONDITIONS	VALUE	UNIT
P _D	Maximum power dissipation (both sides)	AVDD = DVDD = 5.5 V	87	mW
P _{D1}	Maximum power dissipation (high-side supply)	AVDD = 3.6 V	31	mW
		AVDD = 5.5 V	54	
P _{D2}	Maximum power dissipation (low-side supply)	DVDD = 3.6 V	17	mW
		DVDD = 5.5 V	33	

6.6 Insulation Specifications

over operating ambient temperature range (unless otherwise noted)

PARAMETER		TEST CONDITIONS	VALUE	UNIT
GENERAL				
CLR	External clearance ⁽¹⁾	Shortest pin-to-pin distance through air	≥ 8.5	mm
CPG	External creepage ⁽¹⁾	Shortest pin-to-pin distance across the package surface	≥ 8.5	mm
DTI	Distance through insulation	Minimum internal gap (internal clearance) of the double insulation	≥ 0.021	mm
CTI	Comparative tracking index	DIN EN 60112 (VDE 0303-11); IEC 60112	≥ 600	V
	Material group	According to IEC 60664-1	I	
	Overvoltage category per IEC 60664-1	Rated mains voltage ≤ 600 V _{RMS}	I-IV	
		Rated mains voltage ≤ 1000 V _{RMS}	I-III	
DIN EN IEC 60747-17 (VDE 0884-17)⁽²⁾				
V _{IORM}	Maximum repetitive peak isolation voltage	At AC voltage	2120	V _{PK}
V _{IOWM}	Maximum-rated isolation working voltage	At AC voltage (sine wave)	1500	V _{RMS}
		At DC voltage	2120	V _{DC}
V _{IOTM}	Maximum transient isolation voltage	V _{TEST} = V _{IOTM} , t = 60 s (qualification test), V _{TEST} = 1.2 × V _{IOTM} , t = 1 s (100% production test)	7070	V _{PK}
V _{IMP}	Maximum impulse voltage ⁽³⁾	Tested in air, 1.2/50-μs waveform per IEC 62368-1	9800	V _{PK}
V _{IOSM}	Maximum surge isolation voltage ⁽⁴⁾	Tested in oil (qualification test), 1.2/50-μs waveform per IEC 62368-1	12800	V _{PK}
q _{pd}	Apparent charge ⁽⁵⁾	Method a, after input/output safety test subgroups 2 and 3, V _{pd(ini)} = V _{IOTM} , t _{ini} = 60 s, V _{pd(m)} = 1.2 × V _{IORM} , t _m = 10 s	≤ 5	pC
		Method a, after environmental tests subgroup 1, V _{pd(ini)} = V _{IOTM} , t _{ini} = 60 s, V _{pd(m)} = 1.6 × V _{IORM} , t _m = 10 s	≤ 5	
		Method b1, at preconditioning (type test) and routine test, V _{pd(ini)} = 1.2 × V _{IOTM} , t _{ini} = 1 s, V _{pd(m)} = 1.875 × V _{IORM} , t _m = 1 s	≤ 5	
		Method b2, at routine test (100% production) ⁽⁷⁾ , V _{pd(ini)} = V _{pd(m)} = 1.2 × V _{IOTM} , t _{ini} = t _m = 1 s	≤ 5	
C _{IO}	Barrier capacitance, input to output ⁽⁶⁾	V _{IO} = 0.5 V _{PP} at 1 MHz	~1.5	pF
R _{IO}	Insulation resistance, input to output ⁽⁶⁾	V _{IO} = 500 V at T _A = 25°C	> 10 ¹²	Ω
		V _{IO} = 500 V at 100°C ≤ T _A ≤ 125°C	> 10 ¹¹	
		V _{IO} = 500 V at T _S = 150°C	> 10 ⁹	
	Pollution degree		2	
	Climatic category		55/125/21	
UL1577				
V _{ISO}	Withstand isolation voltage	V _{TEST} = V _{ISO} , t = 60 s (qualification test), V _{TEST} = 1.2 × V _{ISO} , t = 1 s (100% production test)	5000	V _{RMS}

- (1) Apply creepage and clearance requirements according to the specific equipment isolation standards of an application. Care must be taken to maintain the creepage and clearance distance of a board design to ensure that the mounting pads of the isolator on the printed circuit board (PCB) do not reduce this distance. Creepage and clearance on a PCB become equal in certain cases. Techniques such as inserting grooves, ribs, or both on a PCB are used to help increase these specifications.
- (2) This coupler is suitable for *safe electrical insulation* only within the safety ratings. Compliance with the safety ratings shall be ensured by means of suitable protective circuits.
- (3) Testing is carried out in air to determine the surge immunity of the package.
- (4) Testing is carried in oil to determine the intrinsic surge immunity of the isolation barrier.
- (5) Apparent charge is electrical discharge caused by a partial discharge (pd).
- (6) All pins on each side of the barrier are tied together, creating a two-pin device.
- (7) Either method b1 or b2 is used in production.

6.7 Safety-Related Certifications

VDE	UL
DIN EN IEC 60747-17 (VDE 0884-17), EN IEC 60747-17, DIN EN IEC 62368-1 (VDE 0868-1), EN IEC 62368-1, IEC 62368-1 Clause : 5.4.3 ; 5.4.4.4 ; 5.4.9	Recognized under 1577 component recognition program
Reinforced insulation	Single protection
Certificate number: 40040142	File number: E181974

6.8 Safety Limiting Values

PARAMETER		TEST CONDITIONS	MIN	TYP	MAX	UNIT
I _S	Safety input, output, or supply current	R _{θJA} = 112.2°C/W, AVDD = DVDD = 5.5 V, T _J = 150°C, T _A = 25°C			203	mA
		R _{θJA} = 112.2°C/W, AVDD = DVDD = 3.6 V, T _J = 150°C, T _A = 25°C			309	
P _S	Safety input, output, or total power ⁽¹⁾	R _{θJA} = 112.2°C/W, T _J = 150°C, T _A = 25°C			1114	mW
T _S	Maximum safety temperature				150	°C

- (1) The maximum safety temperature, T_S, has the same value as the maximum junction temperature, T_J, specified for the device. The I_S and P_S parameters represent the safety current and safety power, respectively. Do not exceed the maximum limits of I_S and P_S. These limits vary with the ambient temperature, T_A.

The junction-to-air thermal resistance, R_{θJA}, in the [Thermal Information](#) table is that of a device installed on a high-K test board for leaded surface-mount packages. Use these equations to calculate the value for each parameter:

$T_J = T_A + R_{\theta JA} \times P$, where P is the power dissipated in the device.

$T_{J(max)} = T_S = T_A + R_{\theta JA} \times P_S$, where T_{J(max)} is the maximum junction temperature.

$P_S = I_S \times AVDD_{max} + I_S \times DVDD_{max}$, where AVDD_{max} is the maximum high-side voltage and DVDD_{max} is the maximum controller-side supply voltage.

6.9 Electrical Characteristics

minimum and maximum specifications are at $T_A = -40^\circ\text{C}$ to 125°C , $AVDD = 3.0\text{ V}$ to 5.5 V , $DVDD = 2.7\text{ V}$ to 5.5 V , $INP = -250\text{ mV}$ to 250 mV , $INN = 0\text{ V}$, and sinc³ filter with $OSR = 256$ (unless otherwise noted); typical specifications are at $T_A = 25^\circ\text{C}$, $CLKIN = 20\text{ MHz}$, $AVDD = 5\text{ V}$, and $DVDD = 3.3\text{ V}$

PARAMETER	TEST CONDITIONS	MIN	TYP	MAX	UNIT
ANALOG INPUTS					
V_{CMov}	Common-mode overvoltage detection level	$(INP + INN) / 2$ to AGND		$AVDD - 2$	V
C_{IN}	Single-ended input capacitance	INN = AGND		2	pF
C_{IND}	Differential input capacitance			1	pF
I_{IB}	Input bias current	INP = INN = AGND, $I_{IB} = I_{BP} + I_{BN}$, $-55^\circ\text{C} \leq T_A \leq 125^\circ\text{C}$		-82 -60 -48	μA
R_{IN}	Single-ended input resistance	INN = AGND, $-55^\circ\text{C} \leq T_A \leq 125^\circ\text{C}$		19	k Ω
R_{IND}	Differential input resistance	$-55^\circ\text{C} \leq T_A \leq 125^\circ\text{C}$		22	k Ω
I_{IO}	Input offset current			± 5	nA
CMTI	Common-mode transient immunity			100 150	kV/ μs
CMRR	Common-mode rejection ratio	INP = INN, $f_{IN} = 0\text{ Hz}$, $V_{CM\ min} \leq V_{IN} \leq V_{CM\ max}$		-95	dB
		INP = INN, f_{IN} from 0.1 Hz to 50 kHz, $V_{CM\ min} \leq V_{IN} \leq V_{CM\ max}$		-95	
BW	Input bandwidth			900	kHz
DC ACCURACY					
DNL	Differential nonlinearity	Resolution: 16 bits, $-55^\circ\text{C} \leq T_A \leq 125^\circ\text{C}$		-0.99 0.99	LSB
INL	Integral nonlinearity ⁽²⁾	Resolution: 16 bits, $-55^\circ\text{C} \leq T_A \leq 125^\circ\text{C}$		-4 ± 1 4	LSB
E_O	Offset error ⁽¹⁾	INP = INN = AGND, $T_A = 25^\circ\text{C}$		-100 ± 4.5 100	μV
		INP = INN = AGND, $T_A = -55^\circ\text{C}$		-180 ± 20 180	
TCE _O	Offset error temperature drift ⁽³⁾			-1 1	$\mu\text{V}/^\circ\text{C}$
E_G	Gain error	$T_A = 25^\circ\text{C}$		-0.2% $\pm 0.005\%$ 0.2%	
		$T_A = -55^\circ\text{C}$		-0.52% $\pm 0.17\%$ 0.52%	
TCE _G	Gain error temperature drift ⁽⁴⁾	$-40^\circ\text{C} \leq T_A \leq 125^\circ\text{C}$		-40 ± 20 40	ppm/ $^\circ\text{C}$
PSRR	Power-supply rejection ratio	INP = INN = AGND, AVDD from 3.0 V to 5.5 V, at DC		-103	dB
		INP = INN = AGND, AVDD from 3.0 V to 5.5 V, 10-kHz / 100-mV ripple		-92	
AC ACCURACY					
SNR	Signal-to-noise ratio	$f_{IN} = 1\text{ kHz}$		82 86	dB
SINAD	Signal-to-noise + distortion	$f_{IN} = 1\text{ kHz}$		81.9 85.7	dB
THD	Total harmonic distortion ⁽⁵⁾	4.5 V \leq AVDD \leq 5.5 V, $f_{IN} = 1\text{ kHz}$, 5 MHz \leq $f_{CLKIN} \leq$ 21 MHz		-98 -86	dB
		3.0 V \leq AVDD \leq 3.6 V, $f_{IN} = 1\text{ kHz}$, 5 MHz \leq $f_{CLKIN} \leq$ 20 MHz		-93 -85	
SFDR	Spurious-free dynamic range	$f_{IN} = 1\text{ kHz}$		83 100	dB
CMOS LOGIC WITH SCHMITT-TRIGGER					
I_{IN}	Input current	$DGND \leq V_{IN} \leq DVDD$		0 7	μA
C_{IN}	Input capacitance			4	pF
V_{IH}	High-level input voltage			$0.7 \times DVDD$ $DVDD + 0.3$	V

6.9 Electrical Characteristics (continued)

minimum and maximum specifications are at $T_A = -40^\circ\text{C}$ to 125°C , $AVDD = 3.0\text{ V}$ to 5.5 V , $DVDD = 2.7\text{ V}$ to 5.5 V , $INP = -250\text{ mV}$ to 250 mV , $INN = 0\text{ V}$, and sinc^3 filter with $\text{OSR} = 256$ (unless otherwise noted); typical specifications are at $T_A = 25^\circ\text{C}$, $\text{CLKIN} = 20\text{ MHz}$, $AVDD = 5\text{ V}$, and $DVDD = 3.3\text{ V}$

PARAMETER		TEST CONDITIONS	MIN	TYP	MAX	UNIT
V_{IL}	Low-level input voltage		-0.3		$0.3 \times DVDD$	V
C_{LOAD}	Output load capacitance			30		pF
V_{OH}	High-level output voltage	$I_{OH} = -4\text{ mA}$, $-55^\circ\text{C} \leq T_A \leq 125^\circ\text{C}$	$DVDD - 0.4$			V
V_{OL}	Low-level output voltage	$I_{OL} = 4\text{ mA}$, $-55^\circ\text{C} \leq T_A \leq 125^\circ\text{C}$			0.4	V
POWER SUPPLY						
I_{AVDD}	High-side supply current	$3.0\text{ V} \leq AVDD \leq 3.6\text{ V}$		6.3	8.5	mA
		$4.5\text{ V} \leq AVDD \leq 5.5\text{ V}$		7.2	9.8	
I_{DVDD}	Low-side supply current	$2.7\text{ V} \leq DVDD \leq 3.6\text{ V}$, $C_{LOAD} = 15\text{ pF}$		3.3	4.8	mA
		$4.5\text{ V} \leq DVDD \leq 5.5\text{ V}$, $C_{LOAD} = 15\text{ pF}$		3.9	6.0	
$AVDD_{UV}$	High-side undervoltage detection threshold	AVDD rising, $-55^\circ\text{C} \leq T_A \leq 125^\circ\text{C}$	2.45	2.7	2.9	V
		AVDD falling, $-55^\circ\text{C} \leq T_A \leq 125^\circ\text{C}$	2.4	2.6	2.8	
$DVDD_{UV}$	Low-side undervoltage detection threshold	DVDD rising, $-55^\circ\text{C} \leq T_A \leq 125^\circ\text{C}$	2.2	2.45	2.65	V
		DVDD falling, $-55^\circ\text{C} \leq T_A \leq 125^\circ\text{C}$	1.75	2.0	2.2	

- (1) This parameter is input referred.
- (2) Integral nonlinearity is defined as the maximum deviation from a straight line passing through the end-points of the ideal ADC transfer function expressed as number of LSBs or as a percent of the specified linear full-scale range FSR.
- (3) Offset error temperature drift is calculated using the box method, as described by the following equation:
 $TCE_O = (E_{O,MAX} - E_{O,MIN}) / TempRange$ where $E_{O,MAX}$ and $E_{O,MIN}$ refer to the maximum and minimum E_O values measured within the temperature range (-40 to 125°C).
- (4) Gain error temperature drift is calculated using the box method, as described by the following equation:
 $TCE_G (ppm) = ((E_{G,MAX} - E_{G,MIN}) / TempRange) \times 10^4$ where $E_{G,MAX}$ and $E_{G,MIN}$ refer to the maximum and minimum E_G values (in %) measured within the temperature range (-40 to 125°C).
- (5) THD is the ratio of the rms sum of the amplitudes of first five higher harmonics to the amplitude of the fundamental.

6.10 Switching Characteristics

PARAMETER		TEST CONDITIONS	MIN	TYP	MAX	UNIT
t_H	DOUT hold time after rising edge of CLKIN	$C_{LOAD} = 15 \text{ pF}$	3.5			ns
t_D	Rising edge of CLKIN to DOUT valid delay	$C_{LOAD} = 15 \text{ pF}$			15	ns
t_r	DOUT rise time	10% to 90%, $2.7 \text{ V} \leq DVDD \leq 3.6 \text{ V}$, $C_{LOAD} = 15 \text{ pF}$		2.5	6	ns
		10% to 90%, $4.5 \text{ V} \leq DVDD \leq 5.5 \text{ V}$, $C_{LOAD} = 15 \text{ pF}$		3.2	6	
t_f	DOUT fall time	10% to 90%, $2.7 \text{ V} \leq DVDD \leq 3.6 \text{ V}$, $C_{LOAD} = 15 \text{ pF}$		2.2	6	ns
		10% to 90%, $4.5 \text{ V} \leq DVDD \leq 5.5 \text{ V}$, $C_{LOAD} = 15 \text{ pF}$		2.9	6	
t_{START}	Device start-up time	AVDD step from 0 to 3.0 V with $DVDD \geq 2.7 \text{ V}$ to bitstream valid, 0.1% settling		0.5		ms

6.11 Timing Diagrams

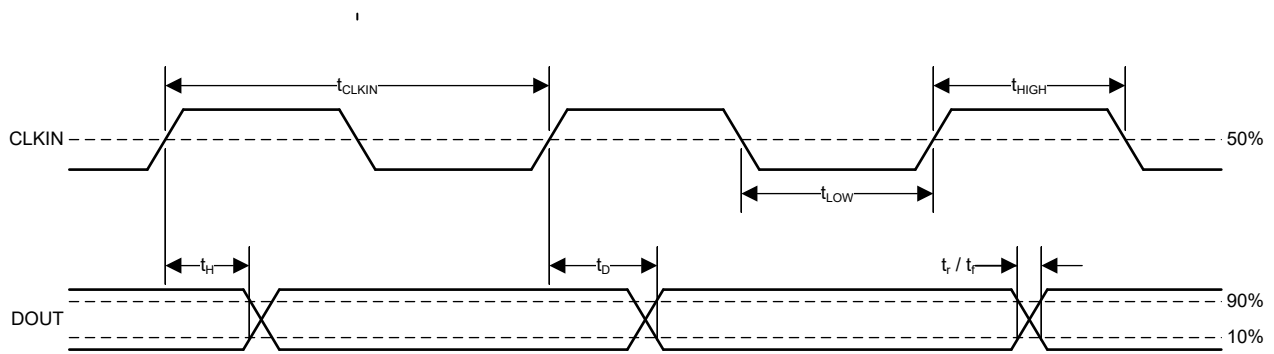

Figure 6-1. Digital Interface Timing

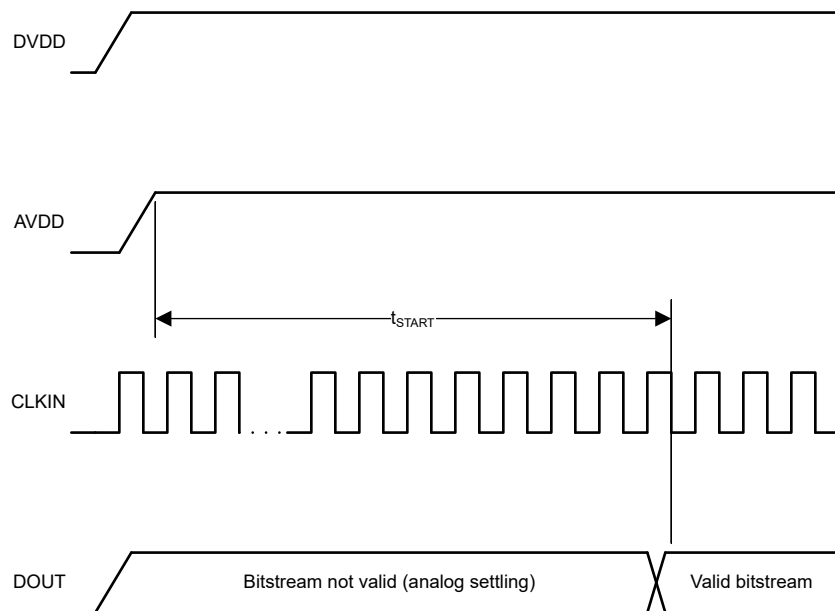
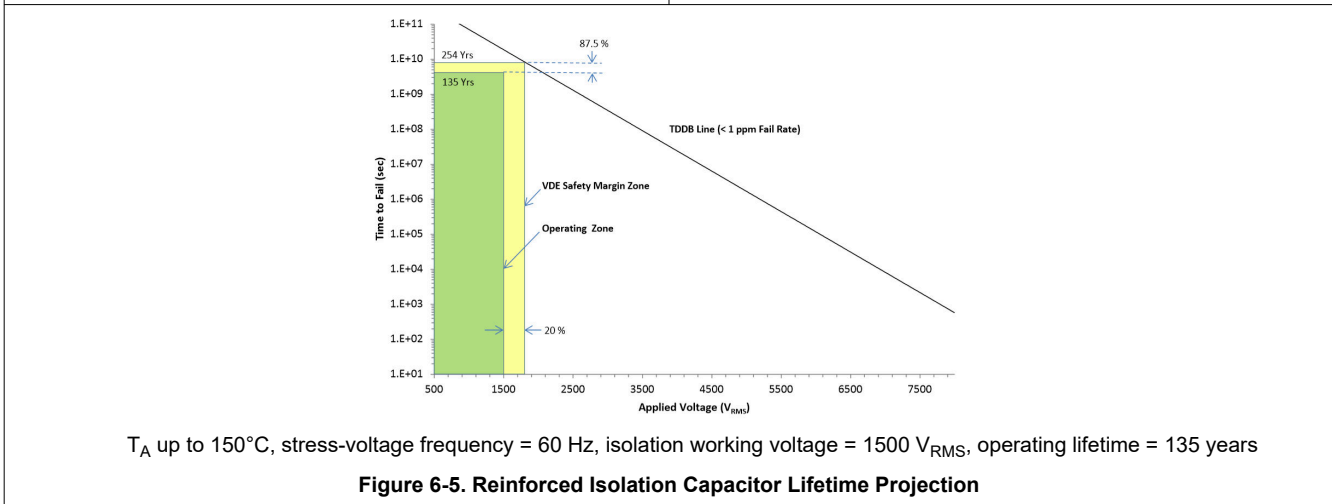
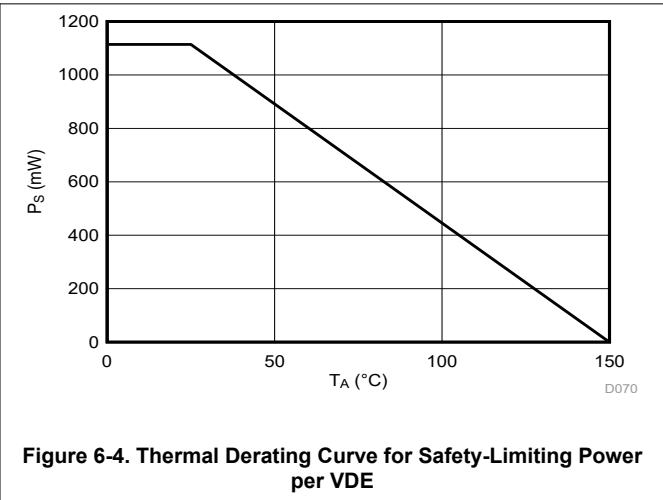
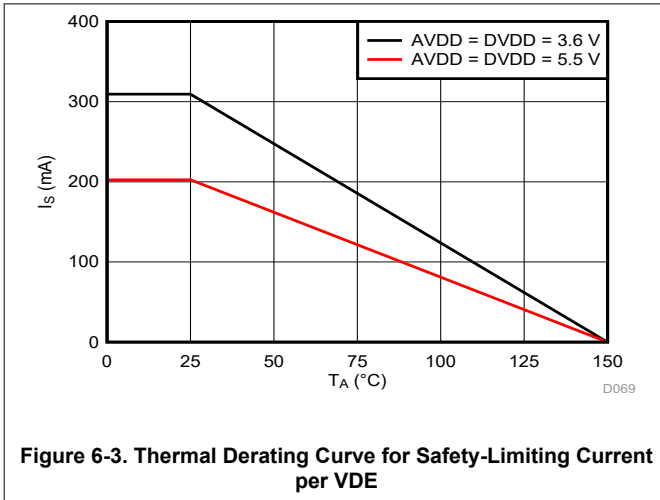

Figure 6-2. Device Start-Up Timing

6.12 Insulation Characteristics Curves



6.13 Typical Characteristics

at AVDD = 5 V, DVDD = 3.3 V, INP = -250 mV to 250 mV, INN = AGND, $f_{CLKIN} = 20$ MHz, and sinc³ filter with OSR = 256 (unless otherwise noted)

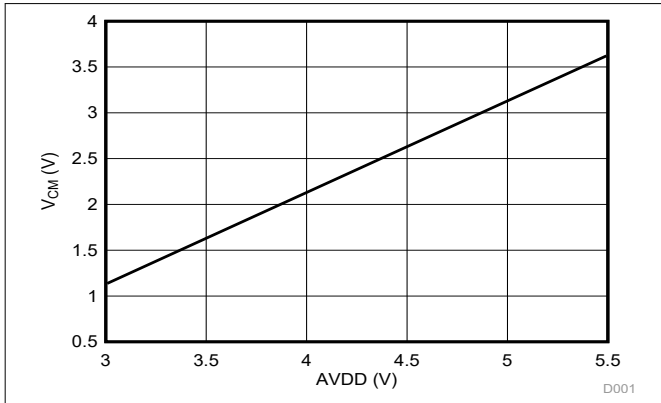

Figure 6-6. Maximum Operating Common-Mode Input Voltage vs High-Side Supply Voltage

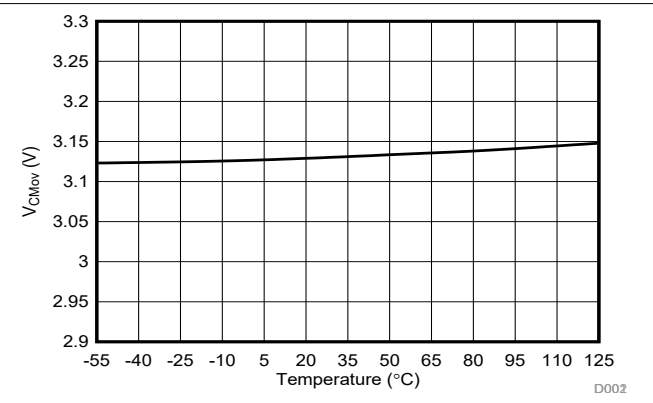

Figure 6-7. Common-Mode Overvoltage Detection Level vs Temperature

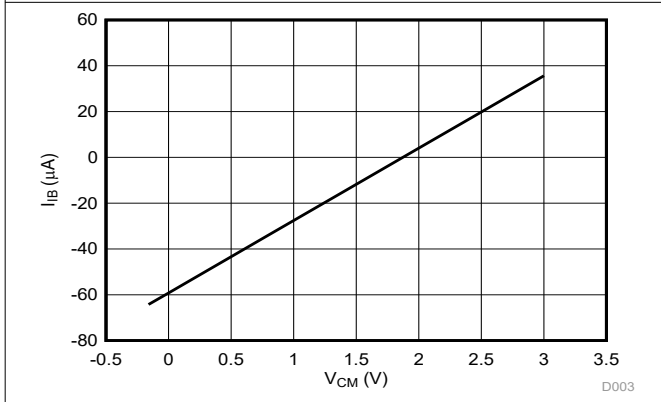

Figure 6-8. Input Bias Current vs Common-Mode Input Voltage

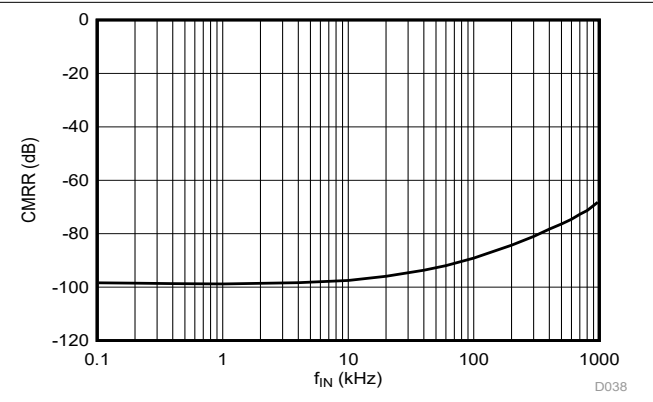

Figure 6-9. Common-Mode Rejection Ratio vs Input Signal Frequency

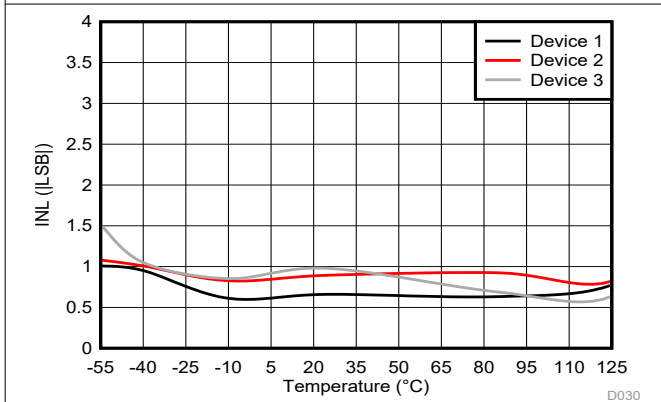

Figure 6-10. Integral Nonlinearity vs Temperature

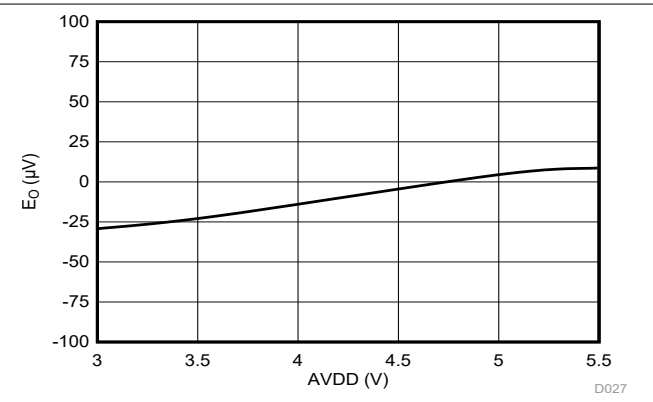
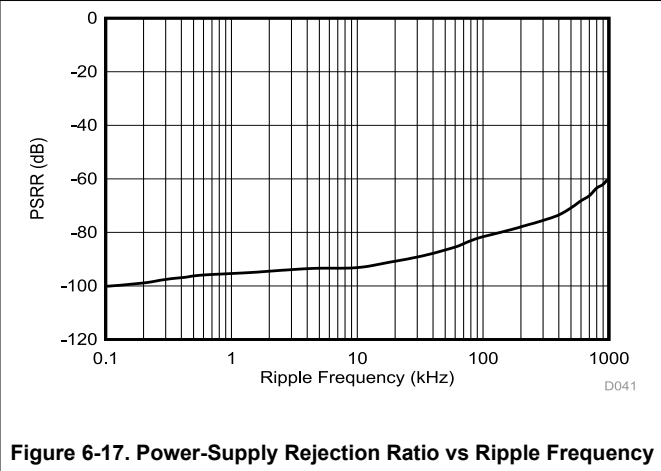
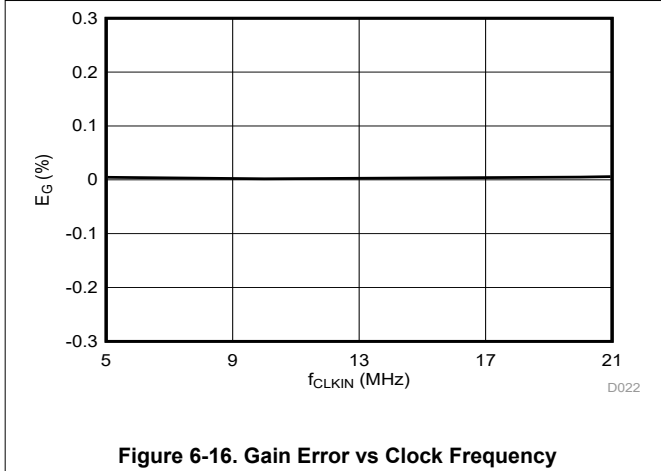
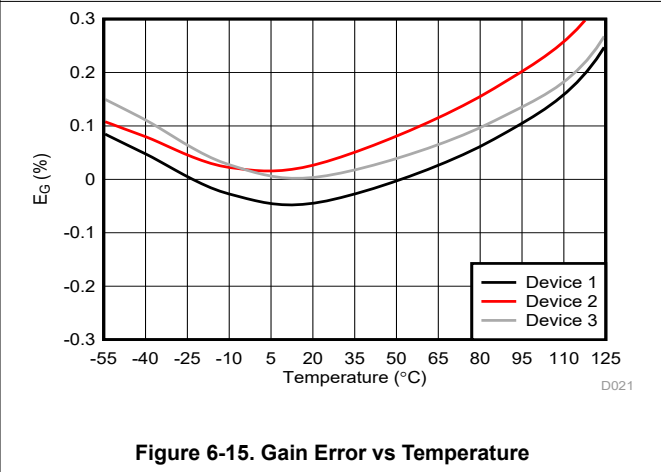
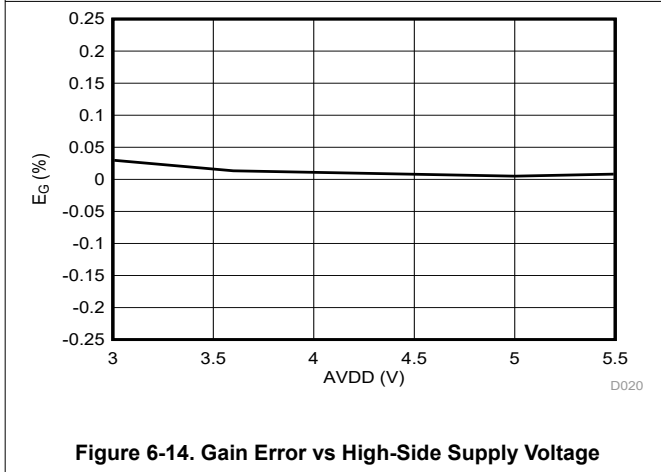
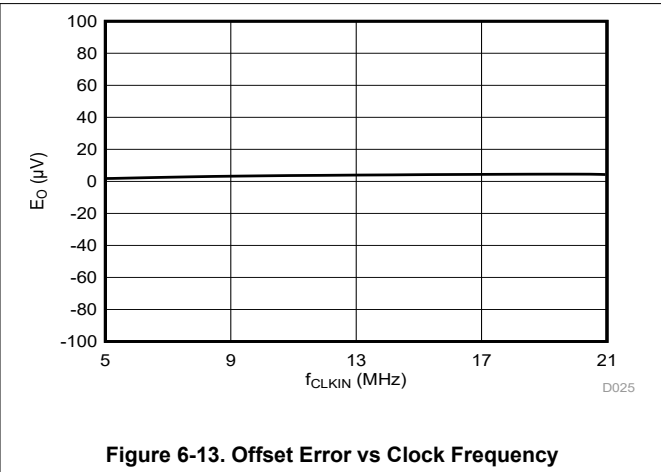
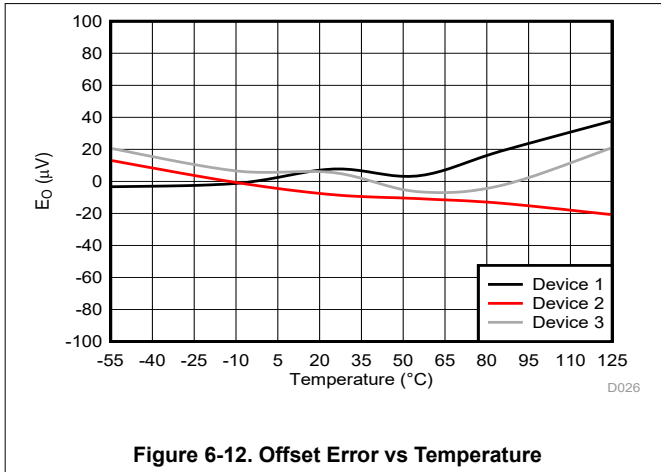

Figure 6-11. Offset Error vs High-Side Supply Voltage

6.13 Typical Characteristics (continued)

at AVDD = 5 V, DVDD = 3.3 V, INP = -250 mV to 250 mV, INN = AGND, f_{CLKIN} = 20 MHz, and sinc³ filter with OSR = 256 (unless otherwise noted)



6.13 Typical Characteristics (continued)

at AVDD = 5 V, DVDD = 3.3 V, INP = -250 mV to 250 mV, INN = AGND, $f_{CLKIN} = 20$ MHz, and sinc³ filter with OSR = 256 (unless otherwise noted)

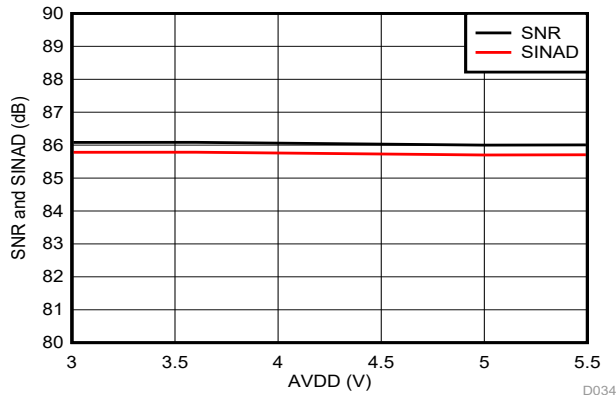

Figure 6-18. Signal-to-Noise Ratio and Signal-to-Noise + Distortion vs High-Side Supply Voltage

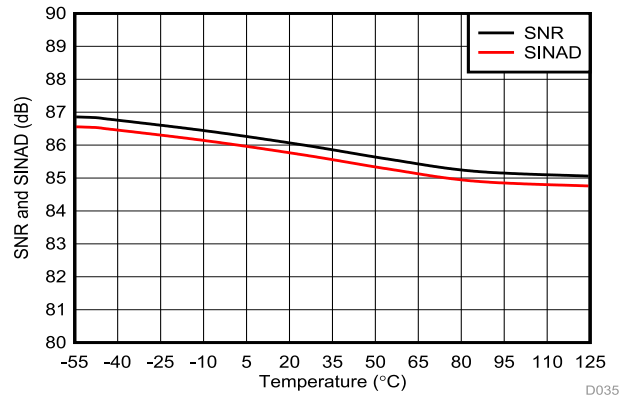

Figure 6-19. Signal-to-Noise Ratio and Signal-to-Noise + Distortion vs Temperature

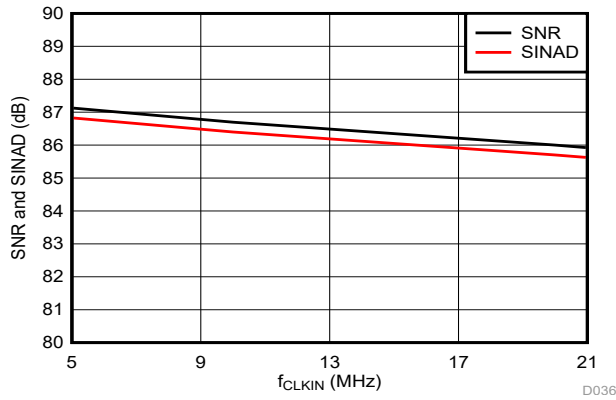

Figure 6-20. Signal-to-Noise Ratio and Signal-to-Noise + Distortion vs Clock Frequency

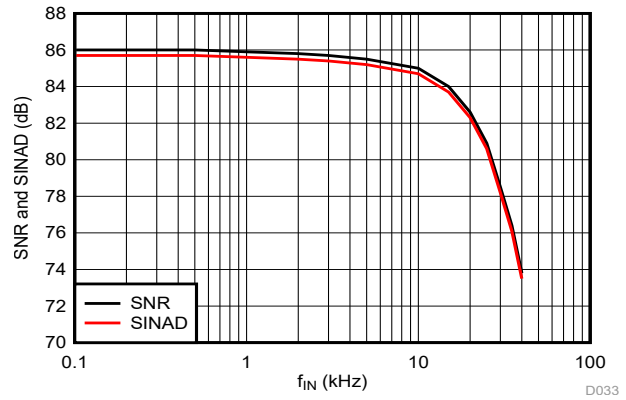

Figure 6-21. Signal-to-Noise Ratio and Signal-to-Noise + Distortion vs Input Signal Frequency

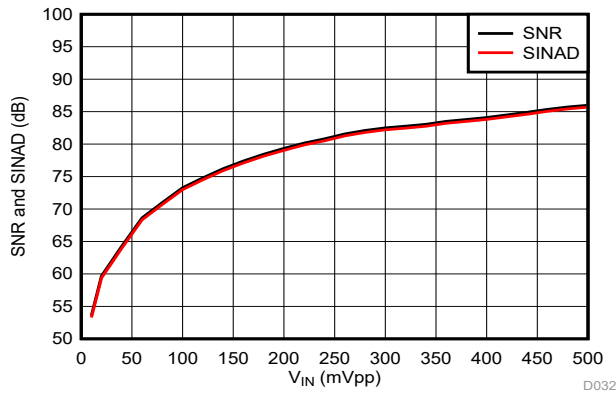

Figure 6-22. Signal-to-Noise Ratio and Signal-to-Noise + Distortion vs Input Signal Amplitude

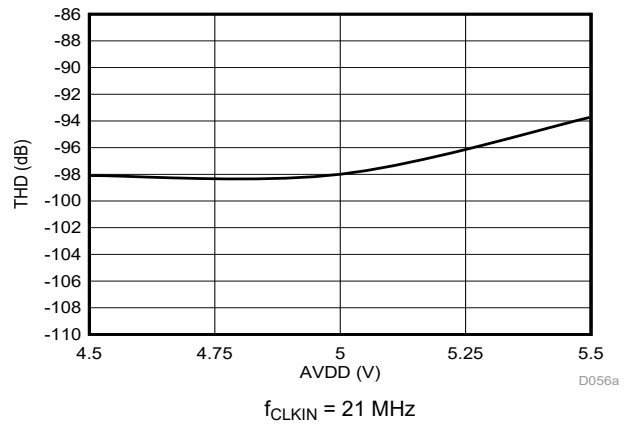

Figure 6-23. Total Harmonic Distortion vs High-Side Supply Voltage (5 V, nom)

6.13 Typical Characteristics (continued)

at AVDD = 5 V, DVDD = 3.3 V, INP = -250 mV to 250 mV, INN = AGND, $f_{CLKIN} = 20$ MHz, and sinc³ filter with OSR = 256 (unless otherwise noted)

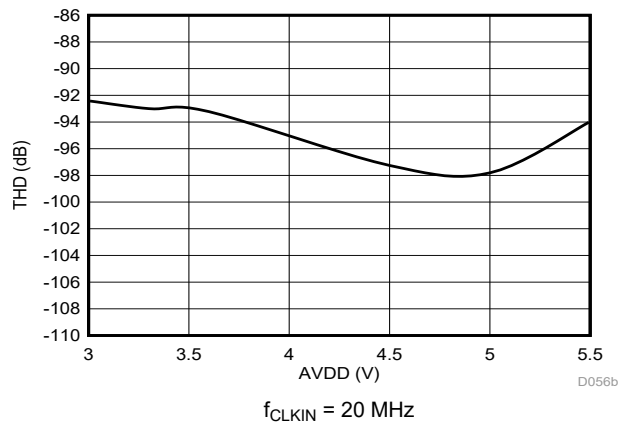

Figure 6-24. Total Harmonic Distortion vs High-Side Supply Voltage (3.3 V, nom)

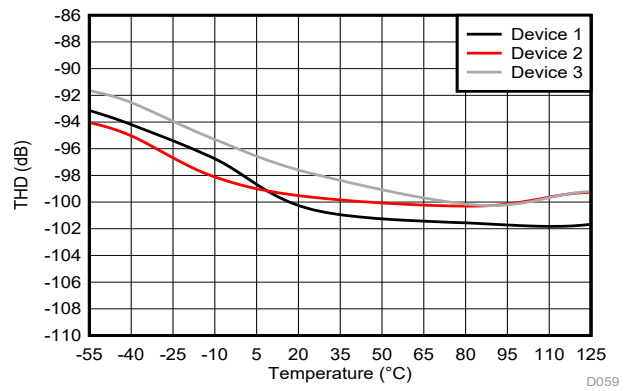

Figure 6-25. Total Harmonic Distortion vs Temperature

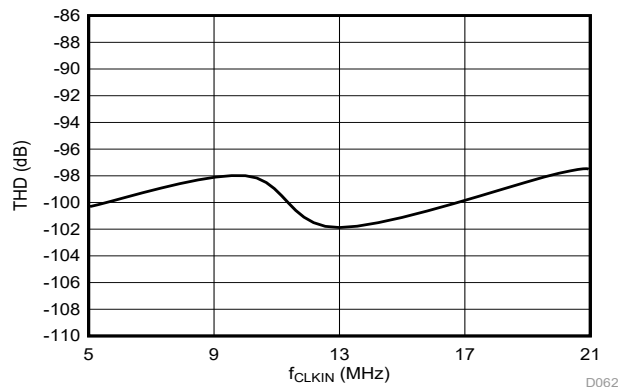

Figure 6-26. Total Harmonic Distortion vs Clock Frequency

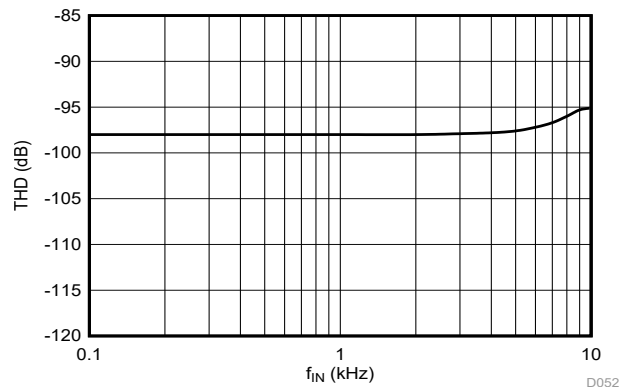

Figure 6-27. Total Harmonic Distortion vs Input Signal Frequency

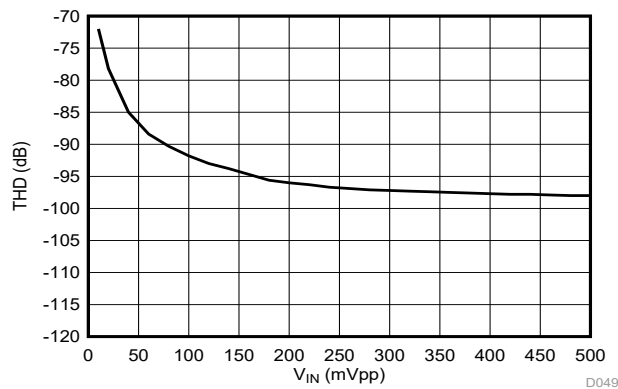

Figure 6-28. Total Harmonic Distortion vs Input Signal Amplitude

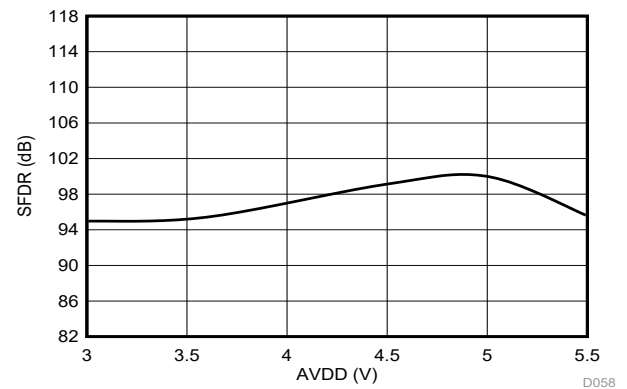

Figure 6-29. Spurious-Free Dynamic Range vs High-Side Supply Voltage

6.13 Typical Characteristics (continued)

at AVDD = 5 V, DVDD = 3.3 V, INP = -250 mV to 250 mV, INN = AGND, $f_{CLKIN} = 20$ MHz, and sinc³ filter with OSR = 256 (unless otherwise noted)

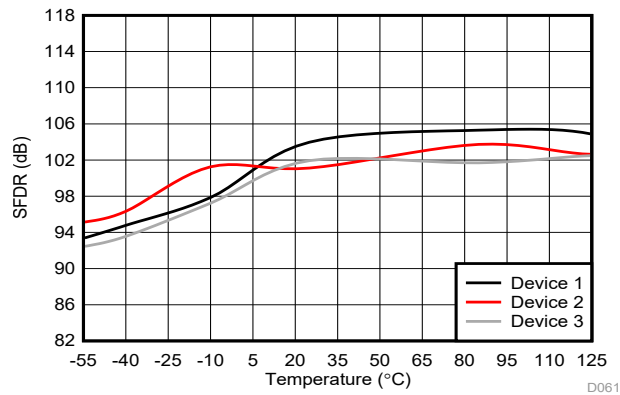

Figure 6-30. Spurious-Free Dynamic Range vs Temperature

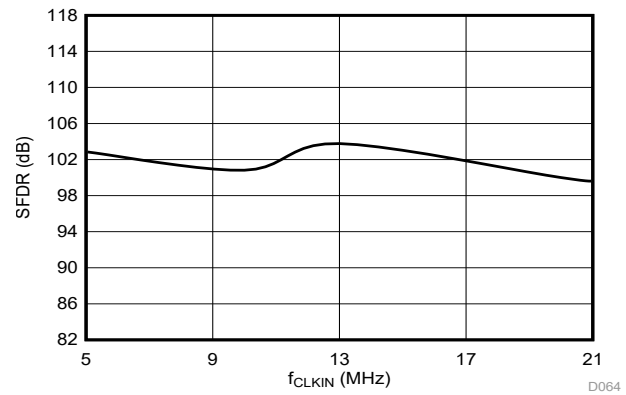

Figure 6-31. Spurious-Free Dynamic Range vs Clock Frequency

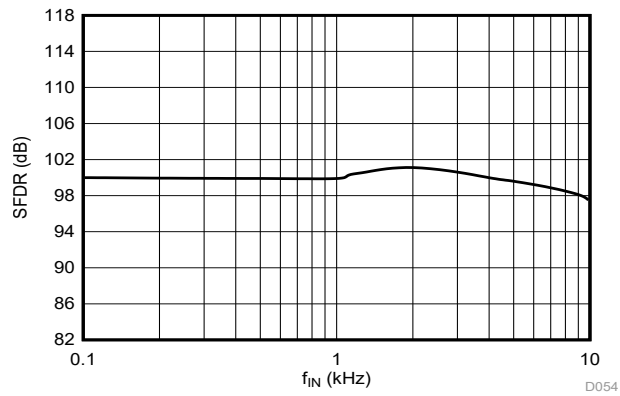

Figure 6-32. Spurious-Free Dynamic Range vs Input Signal Frequency

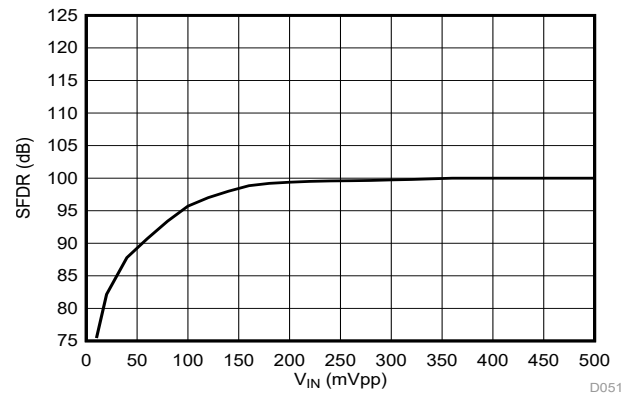

Figure 6-33. Spurious-Free Dynamic Range vs Input Signal Amplitude

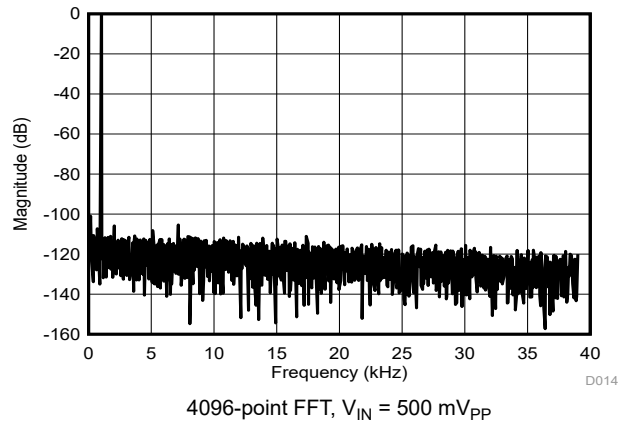

Figure 6-34. Frequency Spectrum With 1-kHz Input Signal

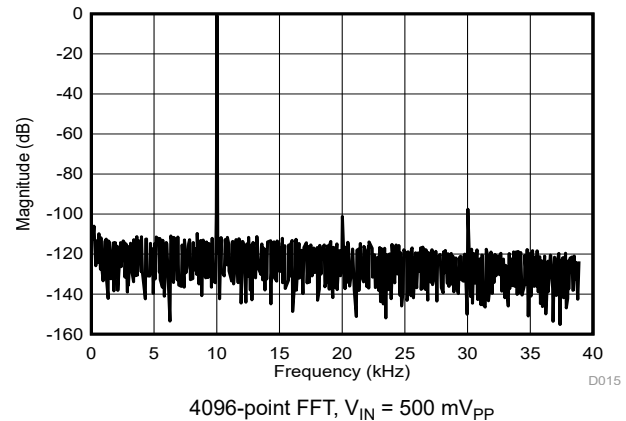

Figure 6-35. Frequency Spectrum With 10-kHz Input Signal

6.13 Typical Characteristics (continued)

at AVDD = 5 V, DVDD = 3.3 V, INP = -250 mV to 250 mV, INN = AGND, f_{CLKIN} = 20 MHz, and sinc³ filter with OSR = 256 (unless otherwise noted)

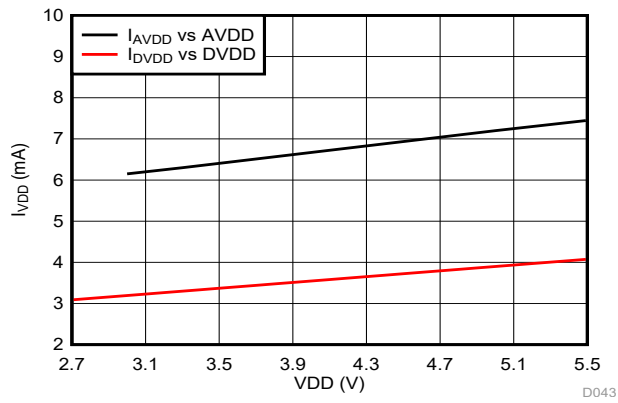

Figure 6-36. Supply Current vs Supply Voltage

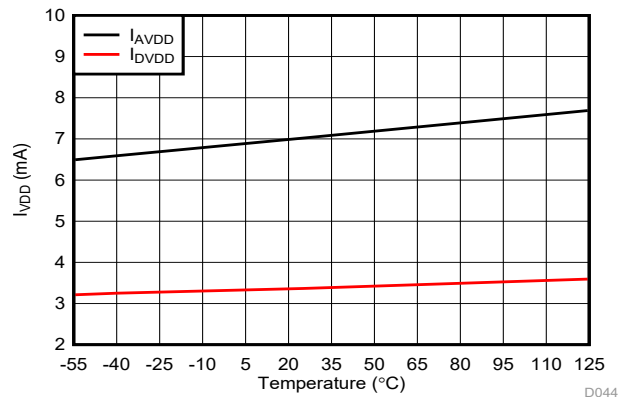

Figure 6-37. Supply Current vs Temperature

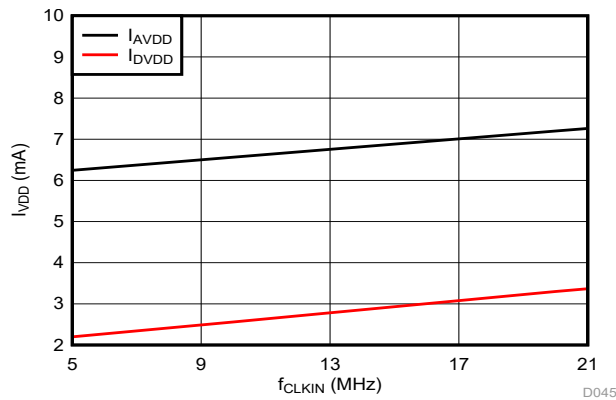

Figure 6-38. Supply Current vs Clock Frequency

7 Detailed Description

7.1 Overview

The input stage of the AMC1306M25E consists of a fully differential amplifier that feeds the switched-capacitor input of a second-order, delta-sigma ($\Delta\Sigma$) modulator. The modulator converts the analog input signal into a digital bitstream that is transferred across the isolation barrier that separates the high-side from the low-side. The isolated data output DOUT of the converter provides a stream of digital ones and zeros that is synchronous to the externally provided clock source at the CLKIN pin. The time average of this serial bitstream output is proportional to the analog input voltage. The external clock input simplifies the synchronization of multiple current-sensing channels on the system level.

The silicon-dioxide (SiO_2) based capacitive isolation barrier supports a high level of magnetic field immunity as described in the [ISO72x Digital Isolator Magnetic-Field Immunity application note](#). The digital modulation used in the AMC1306M25E to transmit data across the isolation barrier, and the isolation barrier characteristics, result in high reliability and common-mode transient immunity.

7.2 Functional Block Diagram

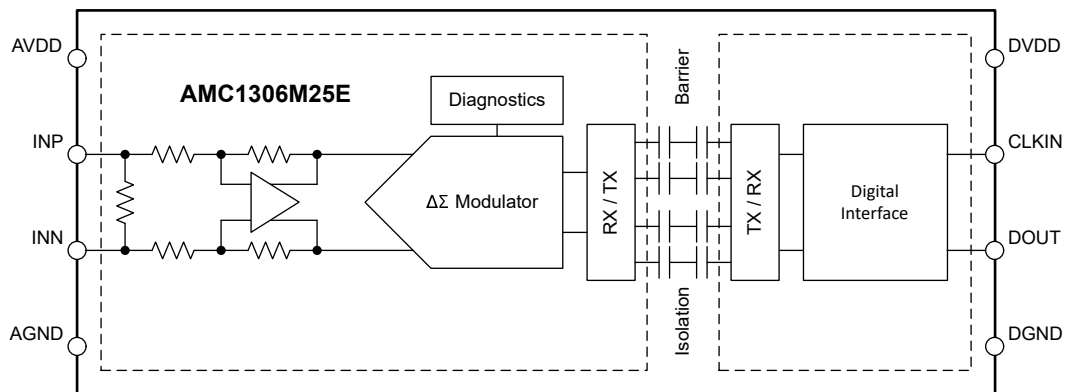

7.3 Feature Description

7.3.1 Analog Input

The differential amplifier input stage of the AMC1306M25E feeds a second-order, switched-capacitor, feed-forward $\Delta\Sigma$ modulator. The gain of the differential amplifier is set by internal precision resistors with a differential input impedance of R_{IND} . The modulator converts the analog input signal into a bitstream that is transferred across the isolation barrier, as described in the [Isolation Channel Signal Transmission](#) section.

For reduced offset and offset drift, the differential amplifier is chopper-stabilized with the switching frequency set at $f_{CLKIN} / 32$. As shown in [Figure 7-1](#), the switching frequency generates a spur at 625 kHz.

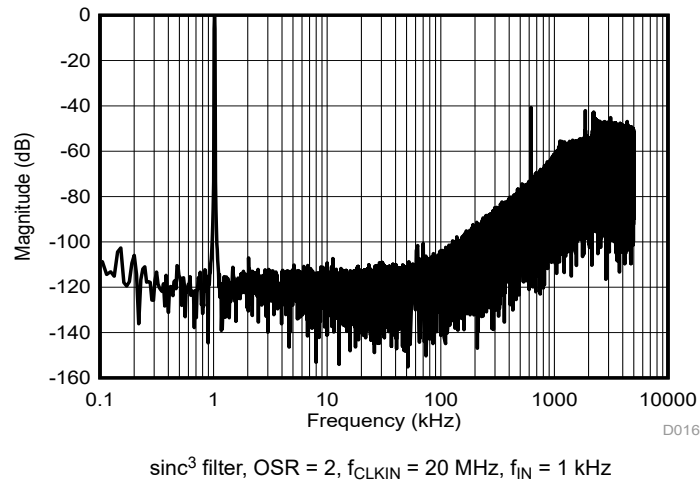

Figure 7-1. Quantization Noise Shaping

There are two restrictions on the analog input signals INP and INN. First, if the input voltages V_{INP} or V_{INN} exceed the range specified in the [Absolute Maximum Ratings](#) table, the input currents must be limited to the absolute maximum value because the electrostatic discharge (ESD) protection turns on. In addition, the linearity and parametric performance of the device are ensured only when the analog input voltage remains within the linear full-scale range (V_{FSR}) and within the common-mode input voltage range (V_{CM}) as specified in the [Recommended Operating Conditions](#) table.

7.3.2 Modulator

[Figure 7-2](#) conceptualizes the second-order, switched-capacitor, feed-forward $\Delta\Sigma$ modulator implemented in the AMC1306M25E. The analog input voltage V_{IN} and the output V_5 of the 1-bit digital-to-analog converter (DAC) are differentiated, providing an analog voltage V_1 at the input of the first integrator stage. The output of the first integrator feeds the input of the second integrator stage, resulting in output voltage V_3 that is differentiated with the input signal V_{IN} and the output of the first integrator V_2 . Depending on the polarity of the resulting voltage V_4 , the output of the comparator is changed. In this case, the 1-bit DAC responds on the next clock pulse by changing the associated analog output voltage V_5 , causing the integrators to progress in the opposite direction, and forcing the value of the integrator output to track the average value of the input.

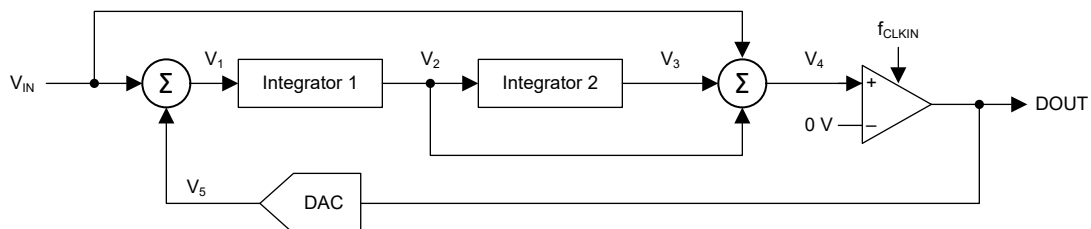

Figure 7-2. Block Diagram of a Second-Order Modulator

The modulator shifts the quantization noise to high frequencies, as illustrated in [Figure 7-1](#). Therefore, use a low-pass digital filter at the output of the device to increase the overall performance. This filter is also used to convert the 1-bit data stream at a high sampling rate into a higher-bit data word at a lower rate (decimation). TI's [C2000™](#) and [Sitara™](#) microcontroller families offer a suitable programmable, hardwired filter structure termed a *sigma-delta filter module* (SDFM) optimized for usage with the AMC1306M25E. Alternatively, a field-programmable gate array (FPGA) or complex programmable logic device (CPLD) can be used to implement the filter.

7.3.3 Isolation Channel Signal Transmission

The AMC1306M25E uses an on-off keying (OOK) modulation scheme, as shown in [Figure 7-3](#), to transmit the modulator output bitstream across the SiO₂-based isolation barrier. The transmit driver (TX) shown in the [Functional Block Diagram](#) transmits an internally generated, high-frequency carrier across the isolation barrier to represent a digital *one* and does not send a signal to represent a digital *zero*. The nominal frequency of the carrier used inside the AMC1306M25E is 480 MHz.

The receiver (RX) on the other side of the isolation barrier recovers and demodulates the signal and produces the output. The AMC1306M25E transmission channel is optimized to achieve the highest level of common-mode transient immunity (CMTI) and lowest level of radiated emissions caused by the high-frequency carrier and RX/TX buffer switching.

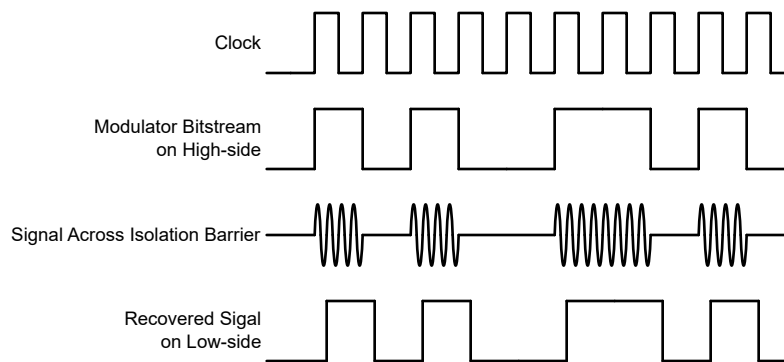

Figure 7-3. OOK-Based Modulation Scheme

7.3.4 Digital Output

A differential input signal of 0 V ideally produces a stream of ones and zeros that are high 50% of the time. A differential input of produces a stream of ones and zeros that are high 89.06% of the time. With 16 bits of resolution, that percentage ideally corresponds to code 58368. A differential input of produces a stream of ones and zeros that are high 10.94% of the time and ideally results in code 7168 with 16-bit resolution. These input voltages are also the specified linear range of the AMC1306M25E. If the input voltage value exceeds this range, the output of the modulator shows nonlinear behavior as the quantization noise increases. The output of the modulator clips with a constant stream of zeros with an input less than or equal to or with a constant stream of ones with an input greater than or equal to . In this case, however, the AMC1306M25E generates a single 1 (if the input is at negative full-scale) or 0 (if the input is at positive full-scale) every 128 clock cycles to indicate proper device function (see the [Output Behavior in Case of a Full-Scale Input](#) section for more details). [Figure 7-4](#) shows the input voltage versus the output modulator signal.

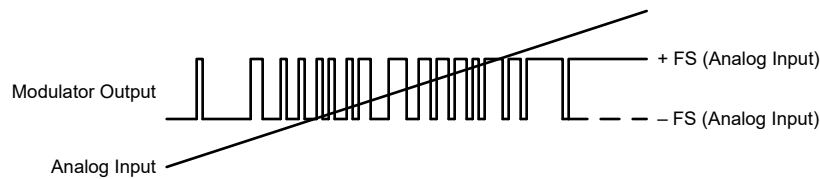

Figure 7-4. AMC1306M25E Modulator Output vs Analog Input

The density of ones in the output bitstream can be calculated using [Equation 1](#) for any input voltage ($V_{IN} = V_{INP} - V_{INN}$) value with the exception of a full-scale input signal, as described in [Equation 1](#):

$$\rho = \frac{V_{IN} + V_{Clipping}}{2 \times V_{Clipping}} \quad (1)$$

7.3.4.1 Output Behavior in Case of a Full-Scale Input

If a full-scale input signal is applied to the AMC1306M25E (that is, $|V_{IN}| \geq |V_{Clipping}|$), the device generates a single one or zero every 128 bits at DOUT, as shown in [Figure 7-5](#), depending on the actual polarity of the signal being sensed. In this way, differentiating between a missing AVDD and a full-scale input signal is possible on the system level.

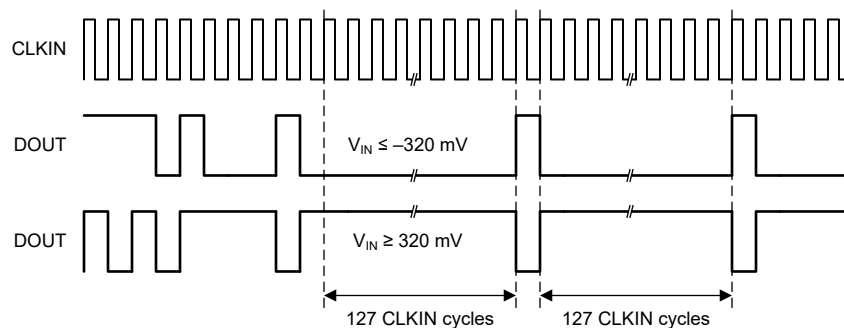

Figure 7-5. Output of the AMC1306M25E in Case of an Input Overage

7.3.4.2 Output Behavior in Case of Input Common-Mode Overrange

If INN or INP is disconnected from the shunt resistor, the input bias current of the AMC1306M25E drives the disconnected terminal towards the positive supply rail, and the common-mode input voltage increases. A similar effect happens when there is no DC current path between INN, INP, and HGND. If the input common-mode voltage exceeds the common-mode overvoltage detection threshold V_{CMov} , the device provides a constant bitstream of logic 1's at the output, as shown in Figure 7-6; that is, DOUT is permanently high. A zero is not generated every 128 clock pulses, which differentiates this condition from a valid positive full-scale input. This feature is useful to identify interconnect problems on the board.

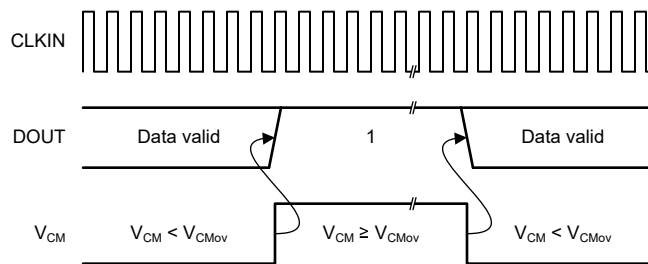

Figure 7-6. Output of the AMC1306M25E in Case of a Common-Mode Overvoltage

There is no common-mode overvoltage detection in the negative direction; thus, if the common-mode input voltage is below the minimum V_{CM} value specified in the [Recommended Operating Conditions](#) table, the bitstream at the DOUT output is not determined.

7.3.4.3 Output Behavior in Case of a Missing High-Side Supply

If the high-side supply is missing, the device provides a constant bitstream of logic 0's at the output, as shown in Figure 7-7; that is, DOUT is permanently low. A one is not generated every 128 clock pulses, which differentiates this condition from a valid negative full-scale input. This feature is useful to identify high-side power-supply problems on the board.

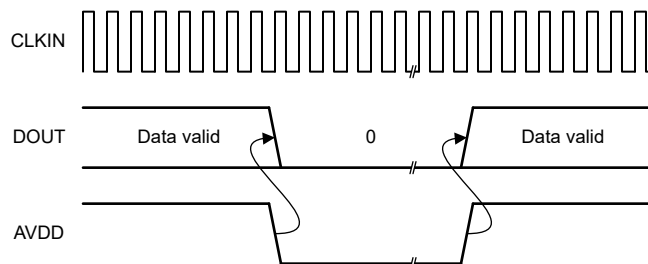

Figure 7-7. Output of the AMC1306M25E in Case of a Missing High-Side Supply

7.4 Device Functional Modes

The AMC1306M25E is operational when the power supplies AVDD and DVDD are applied as specified in the [Recommended Operating Conditions](#) table.

8 Application and Implementation

Note

Information in the following applications sections is not part of the TI component specification, and TI does not warrant its accuracy or completeness. TI's customers are responsible for determining suitability of components for their purposes, as well as validating and testing their design implementation to confirm system functionality.

8.1 Application Information

The low analog input voltage range, excellent accuracy, and low temperature drift make the AMC1306M25E a high-performance solution for applications where shunt-based current sensing in the presence of high common-mode voltage levels is required.

8.2 Typical Application

The AMC1306M25E is designed for shunt-based current-sensing applications where accurate current monitoring is required in the presence of high common-mode voltages.

Figure 8-1 shows the AMC1306M25E in a typical application. The load current flowing through an external shunt resistor RSHUNT produces a voltage drop that is sensed by the AMC1306M25E. The AMC1306M25E digitizes the analog input signal on the high-side, transfers the data across the isolation barrier to the low-side, and outputs the digital bitstream on the DOUT pin. The 5-V high-side power supply (AVDD) is generated from the floating gate driver supply using a resistor (R4) and a Zener diode (D1). The 49.9-Ω resistor on the DOUT pin is used for line-termination and improves signal integrity on the receiving end.

The differential input, digital output, and the high common-mode transient immunity (CMTI) of the AMC1306M25E ensure reliable and accurate operation even in high-noise environments.

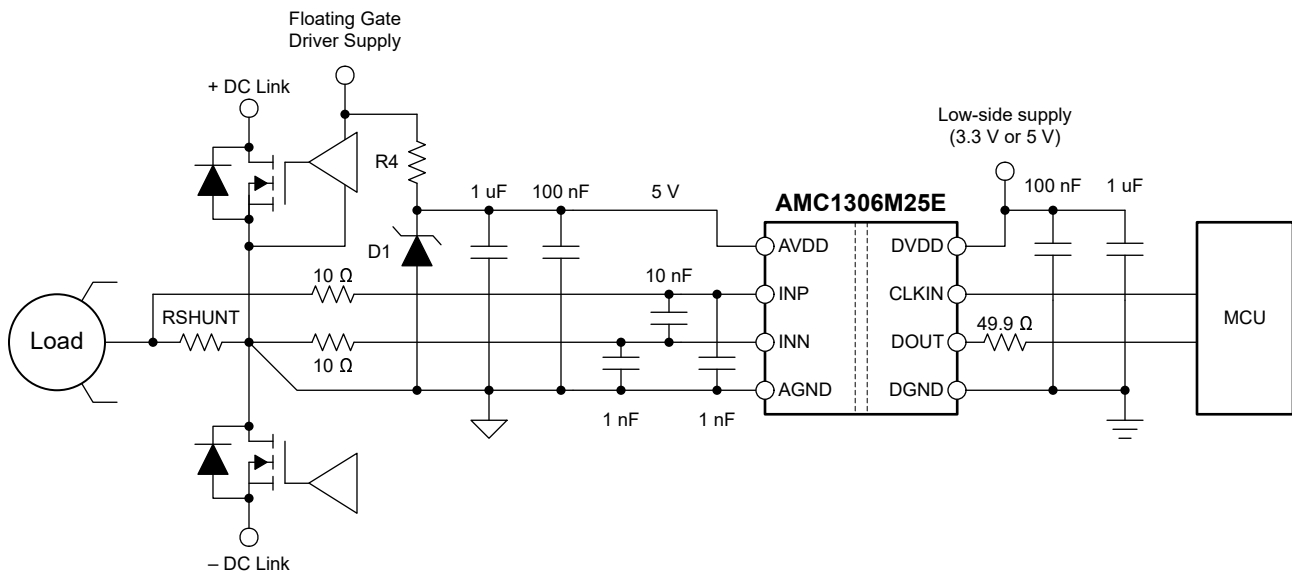

Figure 8-1. Using the AMC1306M25E for Current Sensing in a Typical Application

8.2.1 Design Requirements

Table 8-1 lists the parameters for this typical application.

Table 8-1. Design Requirements

PARAMETER	VALUE
High-side supply voltage	3.3 V or 5 V
Low-side supply voltage	3.3 V or 5 V
Voltage drop across RSHUNT for a linear response	

8.2.2 Detailed Design Procedure

In Figure 8-1, the high-side power supply (AVDD) for the AMC1306M25E is derived from the floating power supply of the upper gate driver, using a resistor (R4) and a Zener diode (D1).

The floating ground reference (AGND) is derived from the end of the shunt resistor that is connected to the negative input of the AMC1306M25E (INN). If a four-pin shunt is used, the inputs of the AMC1306M25E are connected to the inner leads and AGND is connected to the outer lead on the INN-side of the shunt. To minimize offset and improve accuracy, route the ground connection as a separate trace that connects directly to the shunt resistor rather than shorting AGND to INN directly at the input to the device. See the [Layout](#) section for more details.

8.2.2.1 Shunt Resistor Sizing

Use Ohm's Law to calculate the voltage drop across the shunt resistor (V_{SHUNT}) for the desired measured current: $V_{SHUNT} = I \times R_{SHUNT}$.

Consider the following two restrictions when selecting the value of the shunt resistor, RSHUNT:

- The voltage drop caused by the nominal current range must not exceed the recommended differential input voltage range for a linear response: $|V_{SHUNT}| \leq |V_{FSR}|$
- The voltage drop caused by the maximum allowed overcurrent must not exceed the input voltage that causes a clipping output: $|V_{SHUNT}| \leq |V_{Clipping}|$

8.2.2.2 Input Filter Design

Place a differential RC filter (R1, R2, C5) in front of the isolated modulator to improve signal-to-noise performance of the signal path. Design the input filter such that:

- The cutoff frequency of the filter is at least one order of magnitude lower than the sampling frequency (f_{CLKIN}) of the $\Delta\Sigma$ modulator
- The input bias current does not generate significant voltage drop across the DC impedances (R1, R2) of the input filter
- The impedances measured from the analog inputs are equal (R1 equals R2)

Capacitors C6 and C7 are optional and improve common-mode rejection at high frequencies (>1 MHz). For best performance, C6 must match the value of C7 and both capacitors must be 10 to 20 times lower in value than C5. For most applications, the structure shown in Figure 8-2 achieves excellent performance.

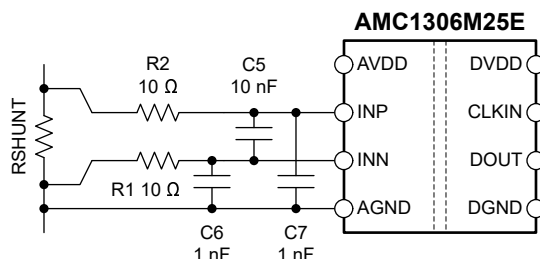

Figure 8-2. Differential Input Filter

8.2.2.3 Bitstream Filtering

The modulator generates a bitstream that is processed by a digital filter to obtain a digital word similar to a conversion result of a conventional analog-to-digital converter (ADC). As described by Equation 2, a very simple filter built with minimal effort and hardware, is a sinc³-type filter:

$$H(z) = \left(\frac{1 - z^{-OSR}}{1 - z^{-1}} \right)^3 \quad (2)$$

This filter provides the best output performance at the lowest hardware size (count of digital gates) for a second-order modulator. All characterization in this document is also done with a sinc³ filter with an oversampling ratio (OSR) of 256 and an output word width of 16 bits, unless specified otherwise. The measured effective number of bits (ENOB) as a function of the OSR is illustrated in Figure 8-3 of the *Typical Application* section.

A *Delta Sigma Modulator Filter Calculator* is available for download at www.ti.com that aids in the filter design and selecting the right OSR and filter order to achieve the desired output resolution and filter response time.

An example code for implementing a sinc³ filter in an FPGA is discussed in the *Combining the ADS1202 with an FPGA Digital Filter for Current Measurement in Motor Control Applications* application note, available for download at www.ti.com.

For modulator output bitstream filtering, a device from TI's C2000™ or Sitara™ microcontroller families is recommended. These families support up to eight channels of dedicated hardwired filter structures that significantly simplify system level design by offering two filtering paths per channel: one providing high-accuracy results for the control loop and one fast-response path for overcurrent detection.

A *delta sigma modulator filter calculator* is available for download at www.ti.com that aids in the filter design and selecting the right OSR and filter order to achieve the desired output resolution and filter response time.

8.2.3 Application Curve

The effective number of bits (ENOB) is often used to compare the performance of ADCs and ΔΣ modulators. Figure 8-3 shows the ENOB of the AMC1306M25E with different oversampling ratios. By using Equation 3, this number can also be calculated from the SINAD:

$$SINAD = 1.76 \text{ dB} + 6.02 \text{ dB} \times ENOB \quad (3)$$

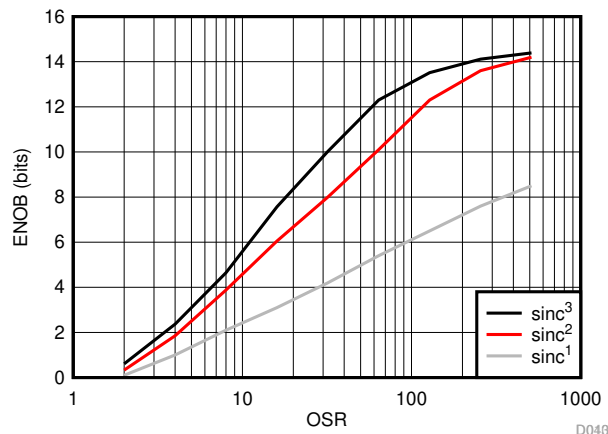

Figure 8-3. Measured Effective Number of Bits vs Oversampling Ratio

8.3 Best Design Practices

Do not leave the inputs of the AMC1306M25E unconnected (floating) when the device is powered up. If the device inputs are left floating, the input bias current can drive the inputs to a positive value that exceeds the operating common-mode input voltage and DOUT is permanently high, as described in the [Output Behavior in Case of Input Common-Mode Overage](#) section.

Connect the high-side ground (AGND) to INN, either by a hard short or through a resistive path. A DC current path between INN and AGND is required to define the input common-mode voltage. Take care not to exceed the input common-mode range as specified in the [Recommended Operating Conditions](#) table. For best accuracy, route the ground connection as a separate trace that connects directly to the shunt resistor rather than shorting AGND to INN directly at the input to the device. See the [Layout](#) section for more details.

8.4 Power Supply Recommendations

The AMC1306M25E does not require any specific power-up sequencing. The high-side power supply (AVDD) is decoupled with a low-ESR, 100-nF capacitor (C1) parallel to a low-ESR, 1- μ F capacitor (C2). The low-side power supply (DVDD) is equally decoupled with a low-ESR, 100-nF capacitor (C3) parallel to a low-ESR, 1- μ F capacitor (C4). Place all four capacitors (C1, C2, C3, and C4) as close to the device as possible.

The ground reference for the high-side (AGND) is derived from the end of the shunt resistor that is connected to the negative input (INN) of the device. For best DC accuracy, use a separate trace to make this connection instead of shorting AGND to INN directly at the device input. If a four-terminal shunt is used, the device inputs are connected to the inner leads and AGND is connected to the outer lead on the INN-side of the shunt. [Figure 8-4](#) shows a decoupling diagram of the AMC1306M25E.

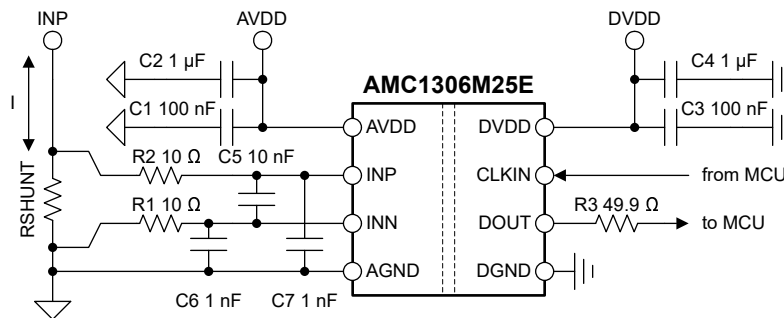

Figure 8-4. Decoupling of the AMC1306M25E

Capacitors must provide adequate effective capacitance under the applicable DC bias conditions they experience in the application. Multilayer ceramic capacitors (MLCC) typically exhibit only a fraction of their nominal capacitance under real-world conditions and this factor must be taken into consideration when selecting these capacitors. This problem is especially acute in low-profile capacitors, in which the dielectric field strength is higher than in taller components. Reputable capacitor manufacturers provide capacitance versus DC bias curves that greatly simplify component selection.

8.5 Layout

8.5.1 Layout Guidelines

Figure 8-5 shows a layout recommendation with the critical placement of the decoupling capacitors (as close as possible to the AMC1306M25E supply pins) and placement of the other components required by the device. For best performance, place the shunt resistor close to the INP and INN inputs of the AMC1306M25E and keep the layout of both connections symmetrical.

8.5.2 Layout Example

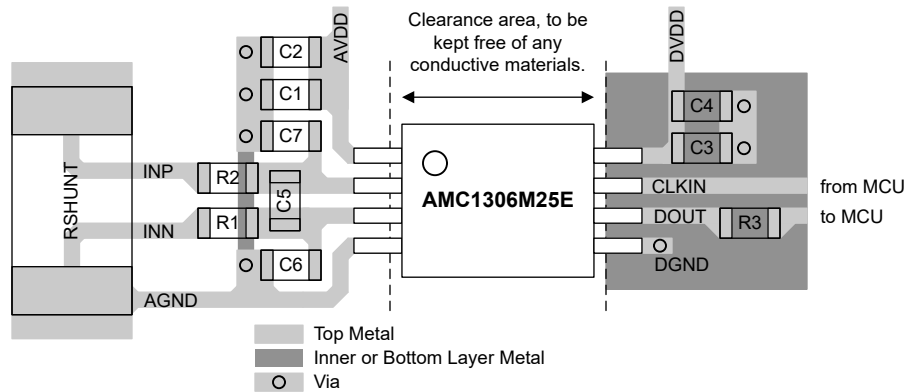

Figure 8-5. Recommended Layout of the AMC1306M25E

9 Device and Documentation Support

9.1 Documentation Support

9.1.1 Related Documentation

For related documentation see the following:

- Texas Instruments, [Isolation Glossary application report](#)
- Texas Instruments, [Semiconductor and IC Package Thermal Metrics application report](#)
- Texas Instruments, [ISO72x Digital Isolator Magnetic-Field Immunity application report](#)
- Texas Instruments, [Delta Sigma Modulator Filter Calculator design tool](#)

9.2 Receiving Notification of Documentation Updates

To receive notification of documentation updates, navigate to the device product folder on ti.com. Click on *Subscribe to updates* to register and receive a weekly digest of any product information that has changed. For change details, review the revision history included in any revised document.

9.3 Support Resources

[TI E2E™ support forums](#) are an engineer's go-to source for fast, verified answers and design help — straight from the experts. Search existing answers or ask your own question to get the quick design help you need.

Linked content is provided "AS IS" by the respective contributors. They do not constitute TI specifications and do not necessarily reflect TI's views; see TI's [Terms of Use](#).

9.4 Trademarks

C2000™, Sitara™, and TI E2E™ are trademarks of Texas Instruments.

All trademarks are the property of their respective owners.

9.5 Electrostatic Discharge Caution



This integrated circuit can be damaged by ESD. Texas Instruments recommends that all integrated circuits be handled with appropriate precautions. Failure to observe proper handling and installation procedures can cause damage.

ESD damage can range from subtle performance degradation to complete device failure. Precision integrated circuits may be more susceptible to damage because very small parametric changes could cause the device not to meet its published specifications.

9.6 Glossary

[TI Glossary](#) This glossary lists and explains terms, acronyms, and definitions.

10 Mechanical, Packaging, and Orderable Information

The following pages include mechanical, packaging, and orderable information. This information is the most current data available for the designated devices. This data is subject to change without notice and revision of this document. For browser-based versions of this data sheet, refer to the left-hand navigation.

PACKAGING INFORMATION

Orderable part number	Status (1)	Material type (2)	Package Pins	Package qty Carrier	RoHS (3)	Lead finish/ Ball material (4)	MSL rating/ Peak reflow (5)	Op temp (°C)	Part marking (6)
AMC1306M25EDWVR	Active	Production	SOIC (DWV) 8	1000 LARGE T&R	Yes	NIPDAU	Level-3-260C-168 HR	-55 to 125	1306M25E
AMC1306M25EDWVR.A	Active	Production	SOIC (DWV) 8	1000 LARGE T&R	Yes	NIPDAU	Level-3-260C-168 HR	-55 to 125	1306M25E

(1) **Status:** For more details on status, see our [product life cycle](#).

(2) **Material type:** When designated, preproduction parts are prototypes/experimental devices, and are not yet approved or released for full production. Testing and final process, including without limitation quality assurance, reliability performance testing, and/or process qualification, may not yet be complete, and this item is subject to further changes or possible discontinuation. If available for ordering, purchases will be subject to an additional waiver at checkout, and are intended for early internal evaluation purposes only. These items are sold without warranties of any kind.

(3) **RoHS values:** Yes, No, RoHS Exempt. See the [TI RoHS Statement](#) for additional information and value definition.

(4) **Lead finish/Ball material:** Parts may have multiple material finish options. Finish options are separated by a vertical ruled line. Lead finish/Ball material values may wrap to two lines if the finish value exceeds the maximum column width.

(5) **MSL rating/Peak reflow:** The moisture sensitivity level ratings and peak solder (reflow) temperatures. In the event that a part has multiple moisture sensitivity ratings, only the lowest level per JEDEC standards is shown. Refer to the shipping label for the actual reflow temperature that will be used to mount the part to the printed circuit board.

(6) **Part marking:** There may be an additional marking, which relates to the logo, the lot trace code information, or the environmental category of the part.

Multiple part markings will be inside parentheses. Only one part marking contained in parentheses and separated by a "~" will appear on a part. If a line is indented then it is a continuation of the previous line and the two combined represent the entire part marking for that device.

Important Information and Disclaimer:The information provided on this page represents TI's knowledge and belief as of the date that it is provided. TI bases its knowledge and belief on information provided by third parties, and makes no representation or warranty as to the accuracy of such information. Efforts are underway to better integrate information from third parties. TI has taken and continues to take reasonable steps to provide representative and accurate information but may not have conducted destructive testing or chemical analysis on incoming materials and chemicals. TI and TI suppliers consider certain information to be proprietary, and thus CAS numbers and other limited information may not be available for release.

In no event shall TI's liability arising out of such information exceed the total purchase price of the TI part(s) at issue in this document sold by TI to Customer on an annual basis.

TAPE AND REEL INFORMATION

QUADRANT ASSIGNMENTS FOR PIN 1 ORIENTATION IN TAPE

*All dimensions are nominal

Device	Package Type	Package Drawing	Pins	SPQ	Reel Diameter (mm)	Reel Width W1 (mm)	A0 (mm)	B0 (mm)	K0 (mm)	P1 (mm)	W (mm)	Pin1 Quadrant
AMC1306M25EDWVR	SOIC	DWV	8	1000	330.0	16.4	12.15	6.2	3.05	16.0	16.0	Q1

TAPE AND REEL BOX DIMENSIONS

*All dimensions are nominal

Device	Package Type	Package Drawing	Pins	SPQ	Length (mm)	Width (mm)	Height (mm)
AMC1306M25EDWVR	SOIC	DWV	8	1000	353.0	353.0	32.0

PACKAGE OUTLINE

DWV0008A



SOIC - 2.8 mm max height

SOIC

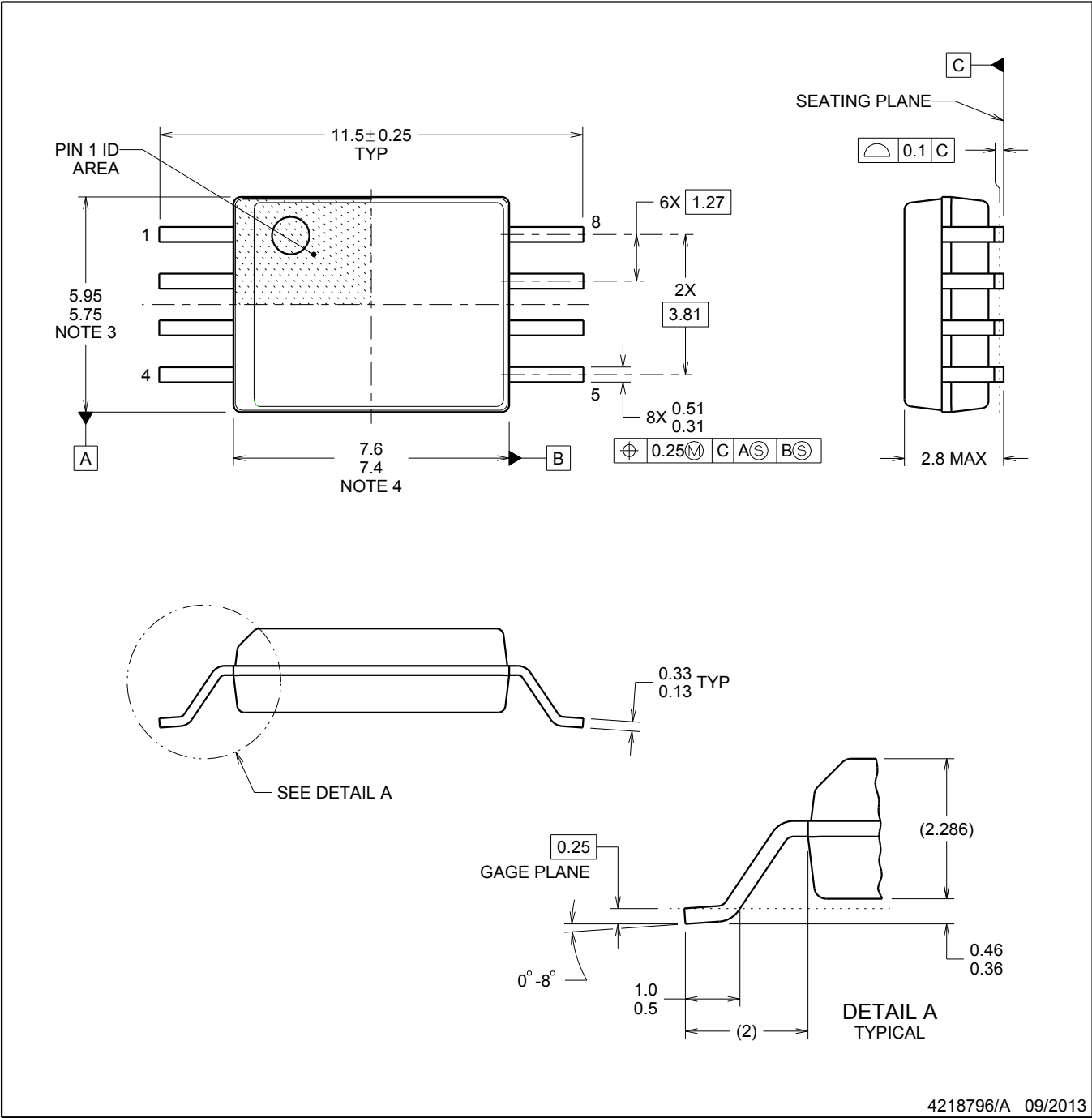

4218796/A 09/2013

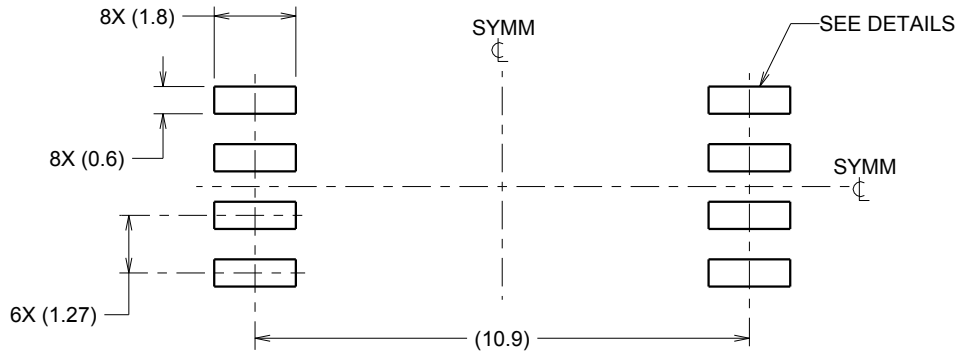

LAND PATTERN EXAMPLE
 9.1 mm NOMINAL CLEARANCE/CREEPAGE
 SCALE:6X

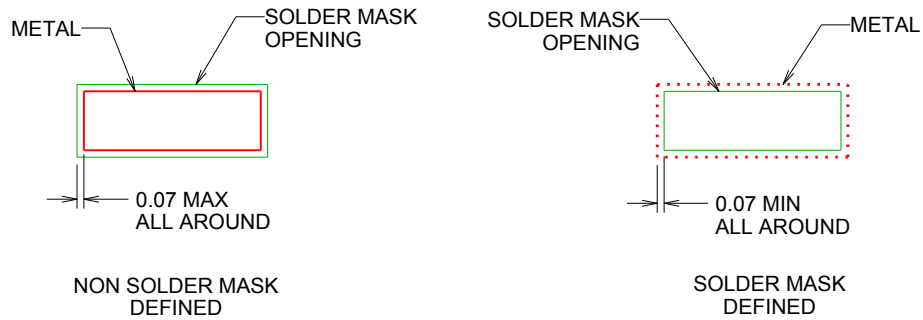

SOLDER MASK DETAILS

4218796/A 09/2013

NOTES: (continued)

- 5. Publication IPC-7351 may have alternate designs.
- 6. Solder mask tolerances between and around signal pads can vary based on board fabrication site.

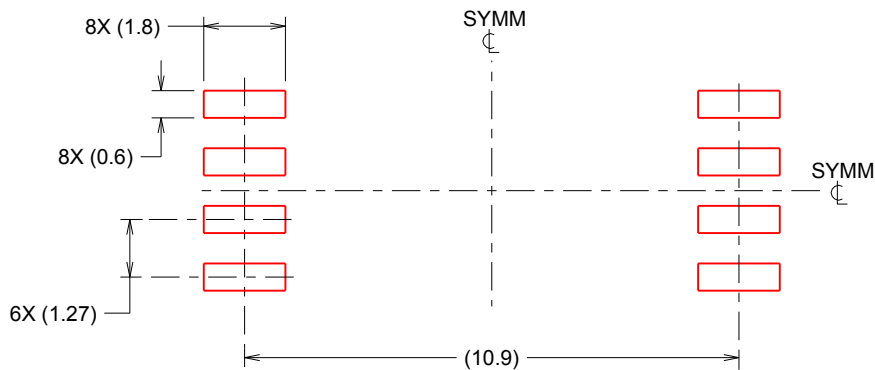

SOLDER PASTE EXAMPLE
 BASED ON 0.125 mm THICK STENCIL
 SCALE:6X

4218796/A 09/2013

NOTES: (continued)

- 7. Laser cutting apertures with trapezoidal walls and rounded corners may offer better paste release. IPC-7525 may have alternate design recommendations.
- 8. Board assembly site may have different recommendations for stencil design.

IMPORTANT NOTICE AND DISCLAIMER

TI PROVIDES TECHNICAL AND RELIABILITY DATA (INCLUDING DATASHEETS), DESIGN RESOURCES (INCLUDING REFERENCE DESIGNS), APPLICATION OR OTHER DESIGN ADVICE, WEB TOOLS, SAFETY INFORMATION, AND OTHER RESOURCES "AS IS" AND WITH ALL FAULTS, AND DISCLAIMS ALL WARRANTIES, EXPRESS AND IMPLIED, INCLUDING WITHOUT LIMITATION ANY IMPLIED WARRANTIES OF MERCHANTABILITY, FITNESS FOR A PARTICULAR PURPOSE OR NON-INFRINGEMENT OF THIRD PARTY INTELLECTUAL PROPERTY RIGHTS.

These resources are intended for skilled developers designing with TI products. You are solely responsible for (1) selecting the appropriate TI products for your application, (2) designing, validating and testing your application, and (3) ensuring your application meets applicable standards, and any other safety, security, regulatory or other requirements.

These resources are subject to change without notice. TI grants you permission to use these resources only for development of an application that uses the TI products described in the resource. Other reproduction and display of these resources is prohibited. No license is granted to any other TI intellectual property right or to any third party intellectual property right. TI disclaims responsibility for, and you fully indemnify TI and its representatives against any claims, damages, costs, losses, and liabilities arising out of your use of these resources.

TI's products are provided subject to [TI's Terms of Sale](#), [TI's General Quality Guidelines](#), or other applicable terms available either on [ti.com](#) or provided in conjunction with such TI products. TI's provision of these resources does not expand or otherwise alter TI's applicable warranties or warranty disclaimers for TI products. Unless TI explicitly designates a product as custom or customer-specified, TI products are standard, catalog, general purpose devices.

TI objects to and rejects any additional or different terms you may propose.

Copyright © 2026, Texas Instruments Incorporated

Last updated 10/2025