

# CC1354R10 SimpleLink™ High-Performance Multiband Wireless MCU

## 1 Features

### Wireless microcontroller

- Powerful 48MHz Arm® Cortex®-M33 processor with TrustZone®
- FPU and DSP extension
- 1024kB flash program memory
- 8kB of cache SRAM
- 256kB of ultra-low leakage SRAM with parity for high-reliability operation
  - 32kB of additional SRAM if parity is disabled
- Dual-band Sub-1GHz and 2.4GHz operation
- Dynamic multiprotocol manager (DMM) driver
- Programmable radio includes support for 2-(G)FSK, 4-(G)FSK, MSK, OOK, IEEE 802.15.4 PHY, and MAC
- Supports over-the-air update (OTA)

### Ultra-low power sensor controller

- Autonomous MCU with 4kB of SRAM
- Sample, store, and process sensor data
- Fast wake-up for low-power operation
- Software defined peripherals; capacitive touch, flow meter, LCD

### Low power consumption

- MCU consumption:
  - 3.4mA active mode, CoreMark®
  - 71µA/MHz running CoreMark®
  - 0.98µA standby mode, RTC, 256kB SRAM
  - 0.17µA shutdown mode, wake-up on pin
- Ultra-low-power sensor controller consumption
  - 32µA in 2MHz mode
  - 849µA in 24MHz mode
- Radio consumption:
  - 5.8mA RX at 868MHz
  - 6.9mA RX at 2.4GHz
  - 25.8mA TX at +14dBm at 868MHz
  - 7.1mA TX at 0dBm at 2.4GHz

### Wireless protocol support

- [Thread](#), [Zigbee®](#), [Matter](#)
- [Bluetooth® 5.3 Low Energy](#)
- [Wi-SUN®](#)
- [mioty®](#)
- [Amazon Sidewalk](#)
- [Wireless M-Bus](#)
- [SimpleLink™ TI 15.4-Stack \(Sub-1GHz\)](#)
- [6LoWPAN](#)
- [Proprietary Systems](#)

### High-performance radio

- -121dBm for 2.5kbps long-range mode
- -110dBm at 50kbps, 802.15.4, 868MHz
- -104dBm for Bluetooth® Low Energy 125kbps
- -105dBm for IEEE 802.15.4-2006 2.4GHz OQPSK (coherent modem)

### Regulatory compliance

- Designed for systems targeting compliance with these standards:
  - ETSI EN 300 220 Receiver Cat. 1.5 and 2, EN 300 328, EN 303 131, EN 303 204, EN 300 440 Cat. 2 and 3
  - FCC CFR47 Part 15
  - ARIB STD-T66, STD-T67, and STD-T108

### MCU peripherals

- Most digital peripherals can be routed to any GPIO
- Four 32-bit or eight 16-bit general-purpose timers
- 12-bit SAR ADC, 200ksps, 8 channels
- 8-bit DAC
- Two comparators
- Programmable current source
- Four UART, four SPI, two I<sup>2</sup>C, one I<sup>2</sup>S
- Real-time clock (RTC)
- Integrated temperature and battery monitor

### Security enablers

- Supports secure boot
- Supports secure key storage and device ID
- Arm® TrustZone® for a trusted execution environment
- AES 128-bit and 256-bit cryptographic accelerator
- Public key accelerator
- SHA2 accelerator (full suite up to SHA-512)
- True random number generator (TRNG)
- Secure debug lock
- Software anti-rollback protection

### Development tools and software

- [LP-EM-CC1354P10-1](#) for dual-band and +20dBm output power on 868MHz or 915MHz
- [LP-EM-CC1354P10-6](#) for dual-band and +10dBm output power on 2.4GHz
- [LP-XDS110](#), [LP-XDS110ET](#) or [TMDSEMU110-U](#) (with [TMDSEMU110-ETH](#) add-on) Debug Probe
- [SimpleLink™ LOWPOWER F2 Software Development Kit \(SDK\)](#)
- [SmartRF™ Studio](#) for simple radio configuration
- [Sensor Controller Studio](#) for building low-power sensing applications



- [SysConfig system configuration tool](#)

### Operating range

- On-chip buck DC/DC converter
- 1.8V to 3.8V single supply voltage
- -40°C to +105°C

### Package

- 7mm × 7mm RGZ VQFN48 (28 GPIOs)
- 8mm × 8mm RSK VQFN64 (42 GPIOs)
- RoHS-compliant package

## 2 Applications

- 315MHz, 433MHz, 470MHz to 510MHz, 868MHz, 902MHz to 928MHz, and 2400 to 2480MHz ISM and SRD systems <sup>1</sup> with down to 4kHz of receive bandwidth
- [Building automation](#)
  - Building security systems—[motion detector](#), [electronic smart lock](#), [door and window sensor](#), [garage door system](#), [gateway](#)
  - HVAC—[thermostat](#), [wireless environmental sensor](#), [HVAC system controller](#), [gateway](#)
  - Fire safety system—[smoke and heat detector](#), [fire alarm control panel \(FACP\)](#)

- Video surveillance—[IP network camera](#)
- Elevators and escalators—[elevator main control panel for elevators and escalators](#)
- [Grid infrastructure](#)
  - Smart meters—[water meter](#), [gas meter](#), [electricity meter](#), and [heat cost allocators](#)
  - Grid communications—[wireless communications](#) and long-range sensor applications
  - Other alternative energy—energy harvesting
- [Industrial transportation](#)—[asset tracking](#)
- [Factory automation and control](#)
- [Medical](#)
- [Communication equipment](#)
  - [Wired networking](#)—[wireless LAN or Wi-Fi access points](#), [edge router](#)
- [Personal electronics](#)
  - [Home theater and entertainment](#)—[smart speakers](#), [smart display](#), [set-top box](#)
  - [Wearables \(non-medical\)](#)—[smart trackers](#), [smart clothing](#)

## 3 Description

The SimpleLink™ CC1354R10 device is a multiprotocol and multiband Sub-1GHz and 2.4GHz wireless microcontroller (MCU) supporting [Thread](#), [Zigbee](#), [Bluetooth 5.3 Low Energy](#), IEEE 802.15.4g, IPv6-enabled smart objects (6LoWPAN), [mioty](#), [Wi-SUN](#), [Amazon Sidewalk](#), [proprietary systems](#), including the TI 15.4-Stack (Sub-1GHz and 2.4GHz), and [concurrent multiprotocol](#) through a [Dynamic Multiprotocol Manager \(DMM\)](#) driver. The device is optimized for low-power wireless communications, with advanced security features and on-chip over-the-air (OAD) update capability. It enables long range and reliable communication in [building security systems](#), [HVAC](#), [smart meters](#), [medical](#), [wired networking](#), [portable electronics](#), [home theater & entertainment](#), and [connected peripherals](#) markets. The highlighted features of this device include:

- Arm® TrustZone® based secure key storage, device ID and trusted functions support.
- Multiband device supporting concurrent multiprotocol for both Sub-1GHz and 2.4GHz through a DMM driver.
- Wide flexibility of protocol stack support in the [SimpleLink LOWPOWER F2 Software Development Kit \(SDK\)](#).
- Longer battery life wireless applications with low standby current of 0.98 μA and full SRAM retention.
- Industrial temperature ready with lowest standby current of 5μA at 85°C.
- Advanced sensing with a programmable, autonomous ultra-low power [Sensor Controller CPU](#) with fast wake-up capability. As an example, the sensor controller is capable of 1Hz ADC sampling at 1μA system current.
- Low [Soft Error Rate \(SER\)](#) Failure-in-Time (FIT) for long operation lifetime with no disruption for industrial markets with always-on SRAM parity against corruption due to potential radiation events.
- Dedicated software controlled radio controller (Arm® Cortex®-M0) providing flexible low-power RF transceiver capability to support multiple physical layers and RF standards.
- Excellent radio sensitivity (-121dBm) and robustness (selectivity and blocking) performance for SimpleLink™ long-range mode.

The CC1354R10 device is part of the SimpleLink™ MCU platform, which consists of Wi-Fi®, Bluetooth® Low Energy, Thread, Zigbee®, Sub-1GHz MCUs, and host MCUs that all share a common, easy-to-use development environment with a single core software development kit (SDK) and rich tool set. A one-time integration of the SimpleLink™ platform enables you to add any combination of the portfolio's devices into your design, allowing

<sup>1</sup> See [RF Core](#) for additional details on supported protocol standards, modulation formats, and data rates.

100 percent code reuse when your design requirements change. For more details, see [the SimpleLink MCU platform](#).

In addition to the software compatibility, within the multiband wireless MCUs, there is pin-to-pin compatibility from 352kB of flash up to 1MB of flash in the 7mm × 7mm QFN package for maximum design scalability. For more information on TI's Sub-1GHz devices, see [www.ti.com/sub1ghz](http://www.ti.com/sub1ghz).

#### Device Information

PART NUMBER	PACKAGE <sup>(1)</sup>	PACKAGE SIZE
CC1354R106T0RGZ	VQFN (48)	7.00mm × 7.00mm
CC1354R106T0RSK	VQFN (64)	8.00mm × 8.00mm

(1) For more information, see the *Mechanical, Packaging, and Orderable* addendum.

## 4 Functional Block Diagram

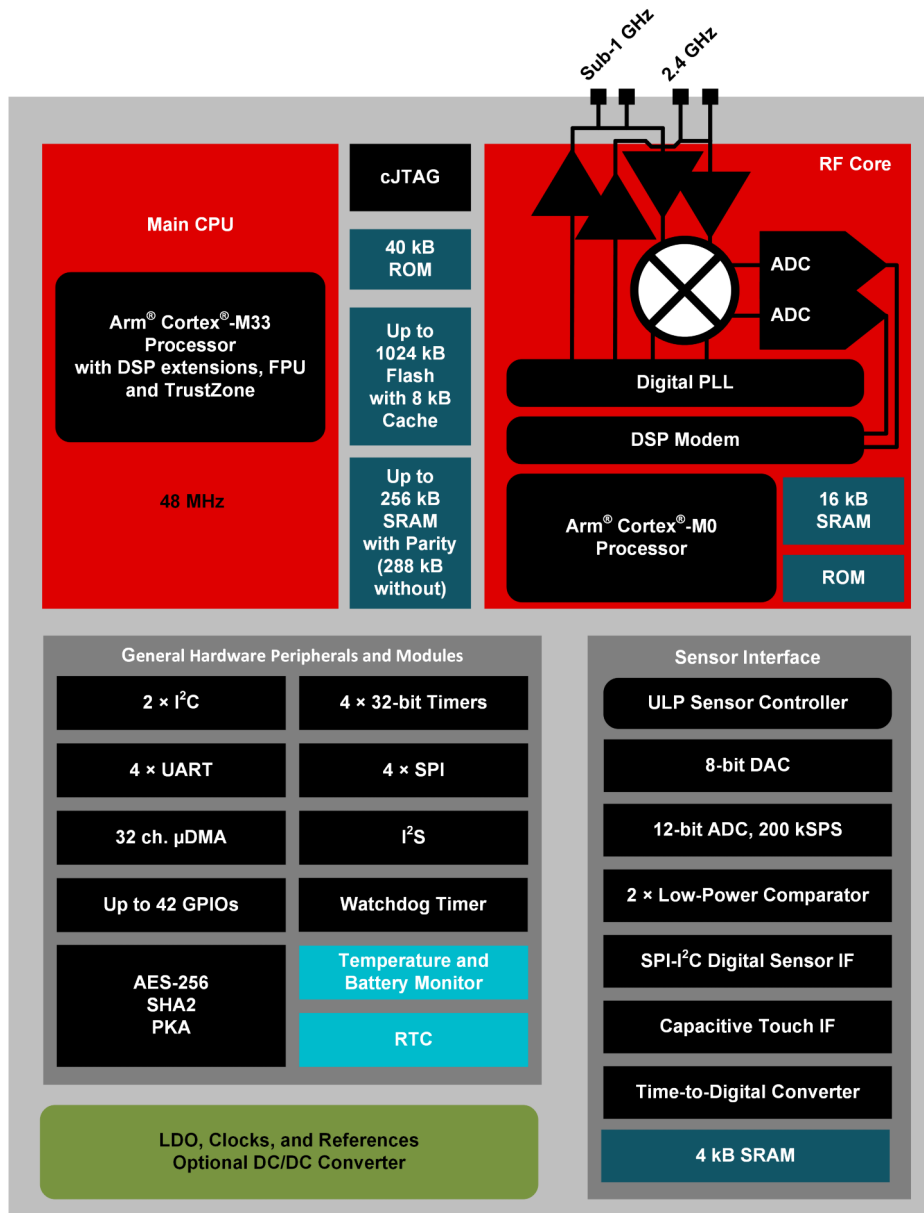

CC1354R10 Block Diagram

## Table of Contents

<b>1 Features</b> .....	1		
<b>2 Applications</b> .....	2	7.17 Zigbee and Thread - IEEE 802.15.4-2006	
<b>3 Description</b> .....	2	2.4GHz (OQPSK DSSS1:8, 250kbps) - TX.....	30
<b>4 Functional Block Diagram</b> .....	4	7.18 Timing and Switching Characteristics.....	30
<b>5 Device Comparison</b> .....	6	7.19 Peripheral Characteristics.....	36
<b>6 Pin Configuration and Functions</b> .....	7	7.20 Typical Characteristics.....	44
6.1 Pin Diagram—RGZ Package (Top View).....	7	<b>8 Detailed Description</b> .....	55
6.2 Signal Descriptions—RGZ Package.....	8	8.1 Overview.....	55
6.3 Connections for Unused Pins and Modules—		8.2 System CPU.....	55
RGZ Package.....	9	8.3 Radio (RF Core).....	56
6.4 Pin Diagram—RSK Package (Top View).....	10	8.4 Memory.....	59
6.5 Signal Descriptions—RSK Package.....	11	8.5 Sensor Controller.....	59
6.6 Connection of Unused Pins and Module—RSK		8.6 Cryptography.....	60
Package.....	13	8.7 Timers.....	61
<b>7 Specifications</b> .....	14	8.8 Serial Peripherals and I/O.....	63
7.1 Absolute Maximum Ratings.....	14	8.9 Battery and Temperature Monitor.....	63
7.2 ESD Ratings.....	14	8.10 $\mu$ DMA.....	63
7.3 Recommended Operating Conditions.....	14	8.11 Debug.....	63
7.4 Power Supply and Modules.....	14	8.12 Power Management.....	64
7.5 Power Consumption—Power Modes.....	15	8.13 Clock Systems.....	65
7.6 Power Consumption—Radio Modes.....	16	8.14 Network Processor.....	65
7.7 Nonvolatile (Flash) Memory Characteristics.....	16	<b>9 Application, Implementation, and Layout</b> .....	66
7.8 Thermal Resistance Characteristics .....	17	9.1 Reference Designs.....	66
7.9 RF Frequency Bands.....	17	9.2 Junction Temperature Calculation.....	67
7.10 861MHz to 1054MHz—Receive (RX).....	17	<b>10 Device and Documentation Support</b> .....	68
7.11 861MHz to 1054MHz—Transmit (TX) .....	24	10.1 Tools and Software.....	68
7.12 861MHz to 1054MHz - PLL Phase Noise		10.2 Documentation Support.....	70
Wideband Mode.....	25	10.3 Support Resources.....	71
7.13 861MHz to 1054MHz - PLL Phase Noise		10.4 Trademarks.....	71
Narrowband Mode.....	25	10.5 Electrostatic Discharge Caution.....	71
7.14 Bluetooth Low Energy—Receive (RX).....	25	10.6 Glossary.....	71
7.15 Bluetooth Low Energy—Transmit (TX).....	28	<b>11 Revision History</b> .....	72
7.16 Zigbee and Thread - IEEE 802.15.4-2006		<b>12 Mechanical, Packaging, and Orderable</b>	
2.4GHz (OQPSK DSSS1:8, 250kbps) - RX.....	28	<b>Information</b> .....	73
		12.1 Packaging Information.....	73

## 5 Device Comparison

Device	RADIO SUPPORT											FLASH (kB)	RAM + Cache (kB)	GPIO	PACKAGE SIZE					
	Sub-1GHz Prop.	2.4GHz Prop.	Wireless M-Bus	mioty	Wi-SUN®	Sidewalk	Bluetooth® LE	Zigbee	Thread	Multiprotocol	+20dBm PA				4 x 4 mm VQFN (24)	4 x 4 mm VQFN (32)	5 x 5 mm VQFN (32)	5 x 5 mm VQFN (40)	7 x 7 mm VQFN (48)	8 x 8 mm VQFN (64)
CC1310	√		√	√								32-128	16-20 + 8	10-30		√	√		√	
CC1311R3	√		√	√								352	32 + 8	22-30				√	√	
CC1311P3	√		√	√							√	352	32 + 8	26					√	
CC1312R	√		√	√	√							352	80 + 8	30					√	
CC1312R7	√		√	√	√	√				√		704	144 + 8	30					√	
CC1314R10	√		√	√	√	√				√		1024	256 + 8	30-46					√	√
CC1352R	√	√	√	√	√		√	√	√	√		352	80 + 8	28					√	
CC1354R10	√	√	√	√	√		√	√	√	√		1024	256 + 8	28-42					√	√
CC1352P	√	√	√	√	√		√	√	√	√	√	352	80 + 8	26					√	
CC1352P7	√	√	√	√	√	√	√	√	√	√	√	704	144 + 8	26					√	
CC1354P10	√	√	√	√	√	√	√	√	√	√	√	1024	256 + 8	26-42					√	√
CC2340R2 <sup>(1)</sup>		√					√	√				256	28	12	√					
CC2340R5 <sup>(2)</sup>		√					√	√	√			512	36	12-26	√			√		
CC2340R5-Q1							√					512	36	19			√			
CC2640R2F							√					128	20 + 8	10-31		√	√		√	
CC2642R							√					352	80 + 8	31					√	
CC2642R-Q1							√					352	80 + 8	31					√	
CC2651R3		√					√	√				352	32 + 8	23-31				√	√	
CC2651P3		√					√	√			√	352	32 + 8	22-26				√	√	
CC2652R		√					√	√	√	√		352	80 + 8	31					√	
CC2652RB		√					√	√	√	√		352	80 + 8	31					√	
CC2652R7		√					√	√	√	√		704	144 + 8	31					√	
CC2652P		√					√	√	√	√	√	352	80 + 8	26					√	
CC2652P7		√					√	√	√	√	√	704	144 + 8	26					√	
CC2674R10		√					√	√	√	√		1024	256 + 8	31-45					√	√
CC2674P10		√					√	√	√	√	√	1024	256 + 8	26-45					√	√

(1) Zigbee and Proprietary RF support enabled by a future software update

(2) Zigbee and Thread support enabled by a future software update

## 6 Pin Configuration and Functions

### 6.1 Pin Diagram—RGZ Package (Top View)

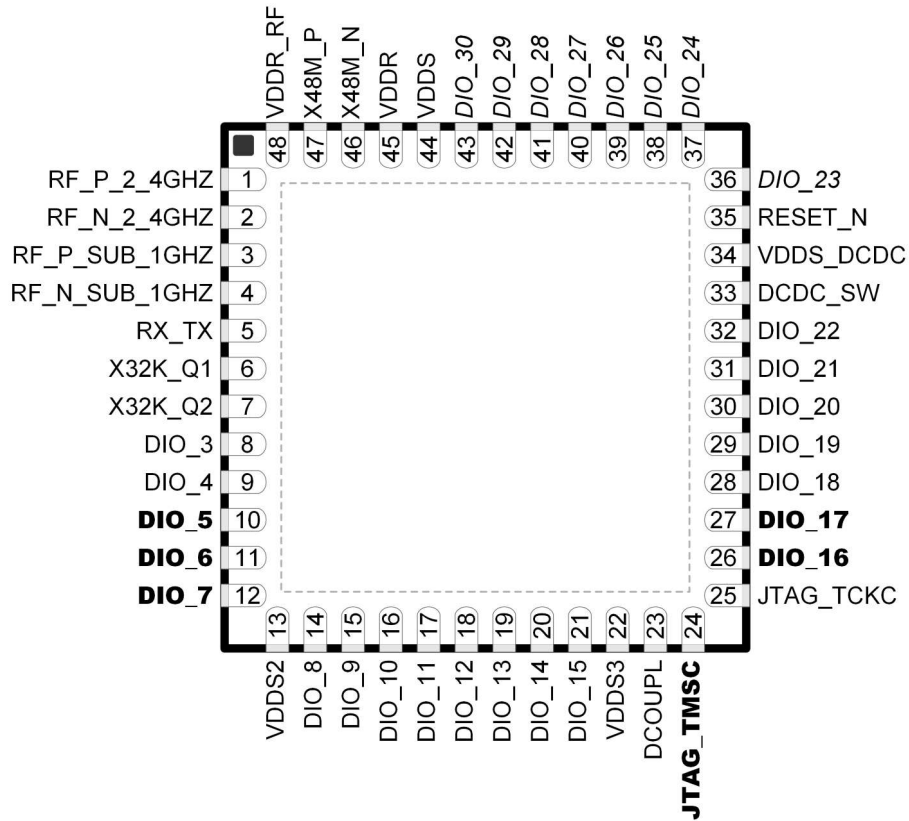

Figure 6-1. RGZ (7mm × 7mm) Pinout, 0.5mm Pitch (Top View)

The following I/O pins marked in [Figure 6-1](#) in **bold** have high-drive capabilities:

- Pin 10, DIO\_5
- Pin 11, DIO\_6
- Pin 12, DIO\_7
- Pin 24, JTAG\_TMISC
- Pin 26, DIO\_16
- Pin 27, DIO\_17

The following I/O pins marked in [Figure 6-1](#) in *italics* have analog capabilities:

- Pin 36, DIO\_23
- Pin 37, DIO\_24
- Pin 38, DIO\_25
- Pin 39, DIO\_26
- Pin 40, DIO\_27
- Pin 41, DIO\_28
- Pin 42, DIO\_29
- Pin 43, DIO\_30

## 6.2 Signal Descriptions—RGZ Package

**Table 6-1. Signal Descriptions—RGZ Package**

PIN		I/O	TYPE	DESCRIPTION
NAME	NO.			
DCDC_SW	33	—	Power	Output from internal DC/DC converter <sup>(1)</sup>
DCOUPPL	23	—	Power	For decoupling of internal 1.27V regulated digital-supply <sup>(2)</sup>
DIO_3	8	I/O	Digital	GPIO
DIO_4	9	I/O	Digital	GPIO
DIO_5	10	I/O	Digital	GPIO, high-drive capability
DIO_6	11	I/O	Digital	GPIO, high-drive capability
DIO_7	12	I/O	Digital	GPIO, high-drive capability
DIO_8	14	I/O	Digital	GPIO
DIO_9	15	I/O	Digital	GPIO
DIO_10	16	I/O	Digital	GPIO
DIO_11	17	I/O	Digital	GPIO
DIO_12	18	I/O	Digital	GPIO
DIO_13	19	I/O	Digital	GPIO
DIO_14	20	I/O	Digital	GPIO
DIO_15	21	I/O	Digital	GPIO
DIO_16	26	I/O	Digital	GPIO, JTAG_TDO, high-drive capability
DIO_17	27	I/O	Digital	GPIO, JTAG_TDI, high-drive capability
DIO_18	28	I/O	Digital	GPIO
DIO_19	29	I/O	Digital	GPIO
DIO_20	30	I/O	Digital	GPIO
DIO_21	31	I/O	Digital	GPIO
DIO_22	32	I/O	Digital	GPIO
DIO_23	36	I/O	Digital or Analog	GPIO, analog capability
DIO_24	37	I/O	Digital or Analog	GPIO, analog capability
DIO_25	38	I/O	Digital or Analog	GPIO, analog capability
DIO_26	39	I/O	Digital or Analog	GPIO, analog capability
DIO_27	40	I/O	Digital or Analog	GPIO, analog capability
DIO_28	41	I/O	Digital or Analog	GPIO, analog capability
DIO_29	42	I/O	Digital or Analog	GPIO, analog capability
DIO_30	43	I/O	Digital or Analog	GPIO, analog capability
EGP	—	—	GND	Ground—exposed ground pad <sup>(3)</sup>
JTAG_TMISC	24	I/O	Digital	JTAG TMISC, high-drive capability
JTAG_TCKC	25	I	Digital	JTAG TCKC
RESET_N	35	I	Digital	Reset, active low. No internal pullup resistor
RF_P_SUB_1GHZ	3	—	RF	Positive Sub-1GHz RF input signal to LNA during RX Positive Sub-1GHz RF output signal from PA during TX
RF_N_SUB_1GHZ	4	—	RF	Negative Sub-1GHz RF input signal to LNA during RX Negative Sub-1GHz RF output signal from PA during TX
RX_TX	5	—	RF	Optional bias pin for the RF LNA
VDDR	45	—	Power	Internal supply, must be powered from the internal DC/DC converter or the internal LDO <sup>(2) (4) (6)</sup>
VDDR_RF	48	—	Power	Internal supply, must be powered from the internal DC/DC converter or the internal LDO <sup>(2) (5) (6)</sup>
VDDS	44	—	Power	1.8V to 3.8V main chip supply <sup>(1)</sup>

**Table 6-1. Signal Descriptions—RGZ Package (continued)**

PIN		I/O	TYPE	DESCRIPTION
NAME	NO.			
VDDS2	13	—	Power	1.8V to 3.8V DIO supply <sup>(1)</sup>
VDDS3	22	—	Power	1.8V to 3.8V DIO supply <sup>(1)</sup>
VDDS_DCDC	34	—	Power	1.8V to 3.8V DC/DC converter supply
X48M_N	46	—	Analog	48MHz crystal oscillator pin N
X48M_P	47	—	Analog	48MHz crystal oscillator pin P
X32K_Q1	6	—	Analog	32kHz crystal oscillator pin 1
X32K_Q2	7	—	Analog	32kHz crystal oscillator pin 2

- (1) For more details, see the technical reference manual listed in [Section 10.2](#).
- (2) Do not supply external circuitry from this pin.
- (3) EGP is the only ground connection for the device. A good electrical connection to the device ground on a printed circuit board (PCB) is imperative for proper device operation.
- (4) If an internal DC/DC converter is not used, this pin is supplied internally from the main LDO.
- (5) If an internal DC/DC converter is not used, this pin must be connected to VDDR for supply from the main LDO.
- (6) Output from internal DC/DC and LDO is trimmed to 1.68V.

### 6.3 Connections for Unused Pins and Modules—RGZ Package

**Table 6-2. Connections for Unused Pins—RGZ Package**

FUNCTION	SIGNAL NAME	PIN NUMBER	ACCEPTABLE PRACTICE <sup>(1)</sup>	PREFERRED PRACTICE <sup>(1)</sup>
GPIO	DIO_n	8–12	NC or GND	NC
		14–21		
		26–32		
		36–43		
32.768 kHz crystal	X32K_Q1	6 8	NC or GND	NC
	X32K_Q2	7		
DC/DC converter <sup>(2)</sup>	DCDC_SW	33	NC	NC
	VDDS_DCDC	34	VDDS	VDDS

- (1) NC = No connect
- (2) When the DC/DC converter is not used, the inductor between DCDC\_SW and VDDR can be removed. VDDR and VDDR\_RF must still be connected and the 22µF DCDC capacitor must be kept on the VDDR net.

## 6.4 Pin Diagram—RSK Package (Top View)

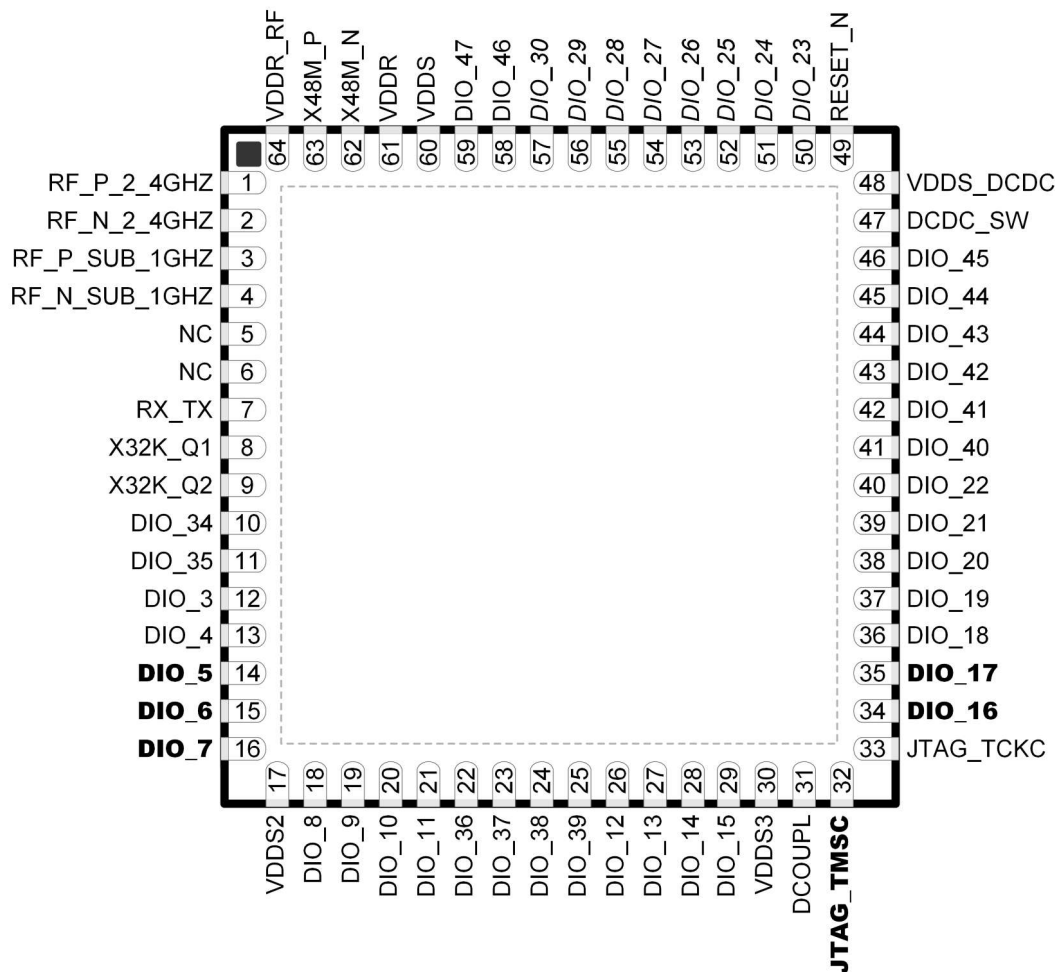

Figure 6-2. RSK (8mm × 8mm) Pinout, 0.4mm Pitch (Top View)

The following I/O pins marked in [Figure 6-2](#) in **bold** have high-drive capabilities:

- Pin 14, DIO\_5
- Pin 15, DIO\_6
- Pin 16, DIO\_7
- Pin 32, JTAG\_TM\_S\_C
- Pin 34, DIO\_16
- Pin 35, DIO\_17

The following I/O pins marked in [Figure 6-2](#) in *italics* have analog capabilities:

- Pin 50, DIO\_23
- Pin 51, DIO\_24
- Pin 52, DIO\_25
- Pin 53, DIO\_26
- Pin 54, DIO\_27
- Pin 55, DIO\_28
- Pin 56, DIO\_29
- Pin 57, DIO\_30

## 6.5 Signal Descriptions—RSK Package

**Table 6-3. Signal Descriptions—RSK Package**

PIN		I/O	TYPE	DESCRIPTION
NAME	NO.			
DCDC_SW	47	—	Power	Output from internal DC/DC converter <sup>(1)</sup>
DCOUPPL	31	—	Power	For decoupling of internal 1.27V regulated digital-supply <sup>(2)</sup>
DIO_3	12	I/O	Digital	GPIO
DIO_4	13	I/O	Digital	GPIO
DIO_5	14	I/O	Digital	GPIO, high-drive capability
DIO_6	15	I/O	Digital	GPIO, high-drive capability
DIO_7	16	I/O	Digital	GPIO, high-drive capability
DIO_8	18	I/O	Digital	GPIO
DIO_9	19	I/O	Digital	GPIO
DIO_10	20	I/O	Digital	GPIO
DIO_11	21	I/O	Digital	GPIO
DIO_12	26	I/O	Digital	GPIO
DIO_13	27	I/O	Digital	GPIO
DIO_14	28	I/O	Digital	GPIO
DIO_15	29	I/O	Digital	GPIO
DIO_16	34	I/O	Digital	GPIO, JTAG_TDO, high-drive capability
DIO_17	35	I/O	Digital	GPIO, JTAG_TDI, high-drive capability
DIO_18	36	I/O	Digital	GPIO
DIO_19	37	I/O	Digital	GPIO
DIO_20	38	I/O	Digital	GPIO
DIO_21	39	I/O	Digital	GPIO
DIO_22	40	I/O	Digital	GPIO
DIO_23	50	I/O	Digital or Analog	GPIO, analog capability
DIO_24	51	I/O	Digital or Analog	GPIO, analog capability
DIO_25	52	I/O	Digital or Analog	GPIO, analog capability
DIO_26	53	I/O	Digital or Analog	GPIO, analog capability
DIO_27	54	I/O	Digital or Analog	GPIO, analog capability
DIO_28	55	I/O	Digital or Analog	GPIO, analog capability
DIO_29	56	I/O	Digital or Analog	GPIO, analog capability
DIO_30	57	I/O	Digital	GPIO, analog capability
DIO_34	10	I/O	Digital	GPIO
DIO_35	11	I/O	Digital	GPIO
DIO_36	22	I/O	Digital	GPIO
DIO_37	23	I/O	Digital	GPIO
DIO_38	24	I/O	Digital	GPIO
DIO_39	25	I/O	Digital	GPIO
DIO_40	41	I/O	Digital	GPIO
DIO_41	42	I/O	Digital	GPIO
DIO_42	43	I/O	Digital	GPIO
DIO_43	44	I/O	Digital	GPIO
DIO_44	45	I/O	Digital	GPIO
DIO_45	46	I/O	Digital	GPIO
DIO_46	58	I/O	Digital	GPIO

**Table 6-3. Signal Descriptions—RSK Package (continued)**

PIN		I/O	TYPE	DESCRIPTION
NAME	NO.			
DIO_47	59	I/O	Digital	GPIO
EGP	—	—	GND	Ground—exposed ground pad <sup>(3)</sup>
JTAG_TMSC	32	I/O	Digital	JTAG TMSC, high-drive capability
JTAG_TCKC	33	I	Digital	JTAG TCKC
RESET_N	49	I	Digital	Reset, active low. No internal pullup resistor
RF_P_2_4GHZ	1	—	RF	Positive 2.4GHz RF input signal to LNA during RX Positive 2.4GHz RF output signal from PA during TX
RF_N_2_4GHZ	2	—	RF	Negative 2.4GHz RF input signal to LNA during RX Negative 2.4GHz RF output signal from PA during TX
RF_P_SUB_1GHZ	3	—	RF	Positive Sub-1GHz RF input signal to LNA during RX Positive Sub-1GHz RF output signal from PA during TX
RF_N_SUB_1GHZ	4	—	RF	Negative Sub-1GHz RF input signal to LNA during RX Negative Sub-1GHz RF output signal from PA during TX
RX_TX	7	—	RF	Optional bias pin for the RF LNA
VDDR	61	—	Power	Internal supply, must be powered from the internal DC/DC converter or the internal LDO <sup>(2) (4) (6)</sup>
VDDR_RF	64	—	Power	Internal supply, must be powered from the internal DC/DC converter or the internal LDO <sup>(2) (5) (6)</sup>
VDDS	60	—	Power	1.8V to 3.8V main chip supply <sup>(1)</sup>
VDDS2	17	—	Power	1.8V to 3.8V DIO supply <sup>(1)</sup>
VDDS3	30	—	Power	1.8V to 3.8V DIO supply <sup>(1)</sup>
VDDS_DCDC	48	—	Power	1.8V to 3.8V DC/DC converter supply
X48M_N	62	—	Analog	48MHz crystal oscillator pin N
X48M_P	63	—	Analog	48MHz crystal oscillator pin P
NC	5	—	—	No connect
NC	6	—	—	No connect
X32K_Q1	8	—	Analog	32kHz crystal oscillator pin 1

- (1) For more details, see technical reference manual listed in the documentation support section.
- (2) Do not supply external circuitry from this pin.
- (3) EGP is the only ground connection for the device. Good electrical connection to device ground on printed circuit board (PCB) is imperative for proper device operation.
- (4) If internal DC/DC converter is not used, this pin is supplied internally from the main LDO.
- (5) If internal DC/DC converter is not used, this pin must be connected to VDDR for supply from the main LDO.
- (6) Output from internal DC/DC and LDO is trimmed to 1.68V.

## 6.6 Connection of Unused Pins and Module—RSK Package

**Table 6-4. Connections for Unused Pins—RSK Package**

FUNCTION	SIGNAL NAME	PIN NUMBER	ACCEPTABLE PRACTICE <sup>(1)</sup>	PREFERRED PRACTICE <sup>(1)</sup>
GPIO	DIO_n	10–16	NC or GND	NC
		14–21		
		26–32		
		36–43		
32.768kHz crystal	X32K_Q1	8	NC or GND	NC
	X32K_Q2	9		
No Connects	NC	5–8	NC	NC
DC/DC converter <sup>(2)</sup>	DCDC_SW	47	NC	NC
	VDDS_DCDC	48	VDDS	VDDS

- (1) NC = No connect  
(2) When the DC/DC converter is not used, the inductor between DCDC\_SW and VDDR can be removed. VDDR and VDDR\_RF must still be connected and the 22µF DCDC capacitor must be kept on the VDDR net.

## 7 Specifications

### 7.1 Absolute Maximum Ratings

Over operating free-air temperature range (unless otherwise noted)<sup>(1) (2)</sup>

		MIN	MAX	UNIT
V <sub>DD</sub> S <sup>(3)</sup>	Supply voltage	-0.3	4.1	V
	Voltage on any digital pin <sup>(4) (5)</sup>	-0.3	V <sub>DD</sub> S + 0.3, max 4.1	V
	Voltage on crystal oscillator pins, X32K_Q1, X32K_Q2, X48M_N and X48M_P	-0.3	V <sub>DD</sub> R + 0.3, max 2.25	V
V <sub>in</sub>	Voltage on ADC input	Voltage scaling enabled	V <sub>DD</sub> S	V
		Voltage scaling disabled, internal reference	1.49	
		Voltage scaling disabled, V <sub>DD</sub> S as reference	V <sub>DD</sub> S / 2.9	
	Input level, Sub-1GHz RF pins		10	dBm
	Input level, 2.4GHz RF pins		5	dBm
T <sub>stg</sub>	Storage temperature	-40	150	°C

- (1) Operation outside the Absolute Maximum Ratings may cause permanent device damage. Absolute Maximum Ratings do not imply functional operation of the device at these or any other conditions beyond those listed under Recommended Operating Conditions. If outside the Recommended Operating Conditions but within the Absolute Maximum Ratings, the device may not be fully functional, and this may affect device reliability, functionality, performance, and shorten the device lifetime.
- (2) All voltage values are with respect to ground, unless otherwise noted.
- (3) V<sub>DD</sub>S\_DCDC, V<sub>DD</sub>S2, and V<sub>DD</sub>S3 must be at the same potential as V<sub>DD</sub>S.
- (4) Including analog capable DIOs.
- (5) Injection current is not supported on any GPIO pin.

### 7.2 ESD Ratings

			VALUE	UNIT	
V <sub>ESD</sub>	Electrostatic discharge	Human body model (HBM), per ANSI/ESDA/JEDEC JS-001 <sup>(1)</sup>	All pins	±2000	V
		Charged device model (CDM), per ANSI/ESDA/JEDEC JS-002 <sup>(2)</sup>	All pins	±500	V

- (1) JEDEC document JEP155 states that 500V HBM allows safe manufacturing with a standard ESD control process
- (2) JEDEC document JEP157 states that 250V CDM allows safe manufacturing with a standard ESD control process

### 7.3 Recommended Operating Conditions

Over operating free-air temperature range (unless otherwise noted)

		MIN	MAX	UNIT
Operating ambient temperature <sup>(1) (3)</sup>		-40	105	°C
Operating supply voltage (V <sub>DD</sub> S)		1.8	3.8	V
Operating supply voltage (V <sub>DD</sub> S), boost mode	V <sub>DD</sub> R = 1.95V +14dBm RF output power	2.1	3.8	V
Rising supply voltage slew rate		0	100	mV/μs
Falling supply voltage slew rate <sup>(2)</sup>		0	20	mV/μs

- (1) Operation at or near maximum operating temperature for extended durations will result in lifetime reduction.
- (2) For small coin-cell batteries, with high worst-case end-of-life equivalent source resistance, a 22 μF V<sub>DD</sub>S input capacitor must be used to ensure compliance with this slew rate.
- (3) For thermal resistance characteristics refer to [Thermal Resistance Characteristics](#). For application considerations, refer to [SPRA953](#)

### 7.4 Power Supply and Modules

Over operating free-air temperature range (unless otherwise noted).

PARAMETER		MIN	TYP	MAX	UNIT
V <sub>DD</sub> S Power-on-Reset (POR) threshold		1.1 - 1.55			V
V <sub>DD</sub> S Brown-out Detector (BOD) <sup>(1)</sup>	Rising threshold	1.77			V
V <sub>DD</sub> S Brown-out Detector (BOD), before initial boot <sup>(2)</sup>	Rising threshold	1.70			V

## 7.4 Power Supply and Modules (continued)

Over operating free-air temperature range (unless otherwise noted).

PARAMETER		MIN	TYP	MAX	UNIT
VDDS Brown-out Detector (BOD) <sup>(1)</sup>	Falling threshold		1.75		V

- (1) For boost mode (VDDR = 1.95 V), TI drivers software initialization will trim VDDS BOD limits to maximum (approximately 2.0 V).  
 (2) Brown-out Detector is trimmed at initial boot, value is kept until device is reset by a POR reset or the RESET\_N pin.

## 7.5 Power Consumption—Power Modes

When measured on the LP-EM-CC1354P10-1 reference design with  $T_c = 25^\circ\text{C}$ ,  $V_{\text{DDS}} = 3.6\text{V}$  with DC/DC enabled unless otherwise noted.

PARAMETER	TEST CONDITIONS	MIN	TYP	MAX	UNIT	
<b>Core Current Consumption</b>						
$I_{\text{core}}$	Reset and Shutdown	Reset. RESET_N pin asserted or VDDS below power-on-reset threshold		150		nA
		Shutdown. No clocks running, no retention		171		
	Standby without cache retention	RTC running, CPU, 256kB RAM and (partial) register retention. RCOSC_LF		0.98		$\mu\text{A}$
		RTC running, CPU, 128kB RAM and (partial) register retention. RCOSC_LF		0.88		
		RTC running, CPU, 256kB RAM and (partial) register retention. XOSC_LF		1.08		
		RTC running, CPU, 128kB RAM and (partial) register retention. XOSC_LF		0.99		
	Standby with cache retention	RTC running, CPU, 256kB RAM and (partial) register retention. RCOSC_LF		2.24		$\mu\text{A}$
		RTC running, CPU, 128kB RAM and (partial) register retention. RCOSC_LF		2.16		
		RTC running, CPU, 256kB RAM and (partial) register retention. XOSC_LF		2.34		
		RTC running, CPU, 128kB RAM and (partial) register retention. XOSC_LF		2.25		
	Idle	Supply Systems and RAM powered. RCOSC_HF		635		$\mu\text{A}$
	Active	MCU running CoreMark at 48MHz with parity enabled. RCOSC_HF		3.5		mA
MCU running CoreMark at 48MHz with parity disabled. RCOSC_HF			3.4			
<b>Peripheral Current Consumption</b>						
$I_{\text{peri}}$	Peripheral power domain	Delta current with domain enabled		62.4		$\mu\text{A}$
	Serial power domain	Delta current with domain enabled		5.83		
	RF Core	Delta current with power domain enabled, clock enabled, RF core idle		102.0		
	$\mu\text{DMA}$	Delta current with clock enabled, module is idle		58.0		
	Timers	Delta current with clock enabled, module is idle <sup>(1)</sup>		97.2		
	I2C	Delta current with clock enabled, module is idle		9.8		
	I2S	Delta current with clock enabled, module is idle		22.2		
	SPI	Delta current with clock enabled, module is idle <sup>(2)</sup>		55.8		
	UART	Delta current with clock enabled, module is idle <sup>(3)</sup>		114.2		
	CRYPTO (AES)	Delta current with clock enabled, module is idle		15.5		
	PKA	Delta current with clock enabled, module is idle		66.6		
	TRNG	Delta current with clock enabled, module is idle		21.0		
<b>Sensor Controller Engine Consumption</b>						

## 7.5 Power Consumption—Power Modes (continued)

When measured on the LP-EM-CC1354P10-1 reference design with  $T_c = 25^\circ\text{C}$ ,  $V_{\text{DDS}} = 3.0\text{V}$  with DC/DC enabled unless otherwise noted.

PARAMETER		TEST CONDITIONS	MIN	TYP	MAX	UNIT
$I_{\text{SCE}}$	Active mode	24MHz, infinite loop, $V_{\text{DDS}} = 3.0\text{V}$		849		$\mu\text{A}$
	Low-power mode	2MHz, infinite loop, $V_{\text{DDS}} = 3.0\text{V}$		32		

- (1) Only one GPTimer running
- (2) Only one SPI running
- (3) Only one UART running

## 7.6 Power Consumption—Radio Modes

When measured on the LP-EM-CC1354P10-1 reference design with  $T_c = 25^\circ\text{C}$ ,  $V_{\text{DDS}} = 3.0\text{V}$  with DC/DC enabled unless otherwise noted.

Using boost mode (increasing VDDR up to 1.95 V), will increase system current by 15% (does not apply to TX +14dBm setting where this current is already included).

Relevant  $I_{\text{core}}$  and  $I_{\text{peri}}$  currents are included in below numbers.

PARAMETER		TEST CONDITIONS	MIN	TYP	MAX	UNIT
$I_{\text{radio}}$	Radio receive current, 868MHz			5.8		mA
$I_{\text{radio}}$	Radio receive current, 2.44GHz (BLE)	$V_{\text{DDS}} = 3.0\text{V}$		6.9		mA
$I_{\text{radio}}$	Radio transmit current Sub-1GHz PA	0dBm output power setting 868MHz		9.5		mA
	Radio transmit current Sub-1GHz PA	+10dBm output power setting 868MHz		14.1		mA
	Radio transmit current Sub-1GHz PA	+14dBm output power setting 868MHz		25.8		mA
$I_{\text{radio}}$	Radio transmit current 2.4GHz PA (BLE)	0dBm output power setting, $V_{\text{DDS}} = 3.0\text{V}$		7.1		mA
	Radio transmit current 2.4GHz PA (BLE)	+5dBm output power setting 2440MHz, $V_{\text{DDS}} = 3.0\text{V}$		9.6		mA

## 7.7 Nonvolatile (Flash) Memory Characteristics

Over operating free-air temperature range and  $V_{\text{DDS}} = 3.0\text{V}$  (unless otherwise noted)

PARAMETER	TEST CONDITIONS	MIN	TYP	MAX	UNIT
Flash sector size			2		kB
Supported flash erase cycles before failure, full bank <sup>(1)</sup> <sup>(2)</sup>		30			k Cycles
Supported flash erase cycles before failure, single sector <sup>(3)</sup>		60			k Cycles
Maximum number of write operations per row before sector erase <sup>(4)</sup>				83	Write Operations
Flash retention	105 °C Tj	11.4			Years
Flash sector erase current	Average delta current		1.0		mA
Flash sector erase time <sup>(5)</sup>	Zero cycles		10		ms
	30k cycles			4000	ms

- (1) A full bank erase is counted as a single erase cycle on each sector.
- (2) Aborting flash during erase or program modes is not a safe operation.
- (3) Up to 4 customer-designated sectors can be individually erased an additional 30k times beyond the baseline bank limitation of 30k cycles.
- (4) Each wordline is 2048 bits (or 256 bytes) wide. This limitation corresponds to sequential memory writes of 4 (3.1) bytes minimum per write over a whole wordline. If additional writes to the same wordline are required, a sector erase is required once the maximum number of write operations per row is reached.
- (5) This number is dependent on Flash aging and increases over time and erase cycles.

## 7.8 Thermal Resistance Characteristics

THERMAL METRIC <sup>(1)</sup>		PACKAGE		UNIT
		RGZ (VQFN)	RSK (VQFN)	
		48 PINS	64 PINS	
R <sub>θJA</sub>	Junction-to-ambient thermal resistance	23.4	25.1	°C/W <sup>(2)</sup>
R <sub>θJC(top)</sub>	Junction-to-case (top) thermal resistance	13.3	11.5	°C/W <sup>(2)</sup>
R <sub>θJB</sub>	Junction-to-board thermal resistance	8.0	8.9	°C/W <sup>(2)</sup>
ψ <sub>JT</sub>	Junction-to-top characterization parameter	0.1	0.1	°C/W <sup>(2)</sup>
ψ <sub>JB</sub>	Junction-to-board characterization parameter	7.9	8.8	°C/W <sup>(2)</sup>
R <sub>θJC(bot)</sub>	Junction-to-case (bottom) thermal resistance	1.7	1.2	°C/W <sup>(2)</sup>

(1) For more information about traditional and new thermal metrics, see [Semiconductor and IC Package Thermal Metrics](#).

(2) °C/W = degrees Celsius per watt.

## 7.9 RF Frequency Bands

Over operating free-air temperature range (unless otherwise noted).

PARAMETER	MIN	TYP	MAX	UNIT
Frequency bands	2360		2500	MHz
	1076		1315	
	861		1054	
	431		527	
	359		439	
	287		351	

### 7.10 861MHz to 1054MHz—Receive (RX)

When measured on the LP-EM-CC1354P10-1 reference design with T<sub>c</sub> = 25°C, V<sub>DD5</sub> = 3.0V with DC/DC enabled unless otherwise noted. All measurements are performed at the antenna input with a combined RX and TX path. All measurements are performed conducted.

PARAMETER	TEST CONDITIONS	MIN	TYP	MAX	UNIT
<b>General Parameters</b>					
Digital channel filter programmable receive bandwidth		4		4000	kHz
Data rate step size			1.5		bps
Spurious emissions 25MHz to 1GHz	868MHz		< -57		dBm
Spurious emissions 1GHz to 13GHz	Conducted emissions measured according to ETSI EN 300 220		< -47		dBm
<b>Wi-SUN, 50kbps, ±12.5kHz deviation, 2-GFSK, 78 kHz RX BW, #1a</b>					
Sensitivity	MRFSK, 866.6MHz, 10% PER, 250 byte payload		-106		dBm
Saturation limit	10% PER, 250 byte payload, 866.6MHz		10		dBm
Selectivity, +100kHz	10% PER, 250 byte payload, 866.6MHz. Wanted signal 3dB above sensitivity level.		33		dB
Selectivity, -100kHz			31		dB
Selectivity, +200kHz			38		dB
Selectivity, -200kHz			37		dB
RSSI dynamic range	Starting from the sensitivity limit		93		dB
RSSI accuracy	Starting from the sensitivity limit across the given dynamic range		±3		dB
<b>Wi-SUN, 50kbps, ±25kHz deviation, 2-GFSK, 100kHz RX BW, #1b</b>					
Sensitivity	MRFSK, 918.2MHz, 10% PER, 250 byte payload		-106		dBm
Saturation limit	10% PER, 250 byte payload, 918.2MHz		10		dBm

## 7.10 861MHz to 1054MHz—Receive (RX) (continued)

When measured on the LP-EM-CC1354P10-1 reference design with  $T_c = 25^\circ\text{C}$ ,  $V_{\text{DDS}} = 3.0\text{V}$  with DC/DC enabled unless otherwise noted. All measurements are performed at the antenna input with a combined RX and TX path. All measurements are performed conducted.

PARAMETER	TEST CONDITIONS	MIN	TYP	MAX	UNIT
Selectivity, +200kHz	10% PER, 250 byte payload, 918.2MHz. Wanted signal 3dB above sensitivity level.		37		dB
Selectivity, -200kHz			35		dB
Selectivity, +400kHz			42		dB
Selectivity, -400kHz			41		dB
RSSI dynamic range	Starting from the sensitivity limit		95		dB
RSSI accuracy	Starting from the sensitivity limit across the given dynamic range		±3		dB
<b>Wi-SUN, 100kbps, ±25kHz deviation, 2-GFSK, 135kHz RX BW, #2a</b>					
Sensitivity	MRFSK, 866.6MHz, 10% PER, 250 byte payload		-103		dBm
Saturation limit	10% PER, 250 byte payload, 866.6MHz		10		dBm
Selectivity, +200kHz	10% PER, 250 byte payload, 866.6MHz. Wanted signal 3dB above sensitivity level.		40		dB
Selectivity, -200kHz			38		dB
Selectivity, +400kHz			46		dB
Selectivity, -400kHz			44		dB
RSSI dynamic range	Starting from the sensitivity limit		95		dB
RSSI accuracy	Starting from the sensitivity limit across the given dynamic range		±3		dB
<b>Wi-SUN, 100kbps, ±50kHz deviation, 2-GFSK, 208 kHz RX BW, #2b</b>					
Sensitivity	MRFSK, 920.9MHz, 10% PER, 250 byte payload		-102		dBm
Saturation limit	10% PER, 250 byte payload, 920.9MHz		10		dBm
Selectivity, +400kHz	10% PER, 250 byte payload, 920.9MHz. Wanted signal 3dB above sensitivity level, modulated blocker.		42		dB
Selectivity, -400kHz			39		dB
Selectivity, +800kHz			52		dB
Selectivity, -800kHz			46		dB
RSSI dynamic range	Starting from the sensitivity limit		91		dB
RSSI accuracy	Starting from the sensitivity limit across the given dynamic range		±3		dB
<b>Wi-SUN, 150kbps, ±37.5kHz deviation, 2-GFSK, 273 kHz RX BW, #3</b>					
Sensitivity	MRFSK, 918.4MHz, 10% PER, 250 byte payload		-99		dBm
Saturation limit	10% PER, 250 byte payload, 918.4MHz		10		dBm
Selectivity, +400kHz	10% PER, 250 byte payload, 918.4MHz. Wanted signal 3dB above sensitivity level.		41		dB
Selectivity, -400kHz			39		dB
Selectivity, +800kHz			50		dB
Selectivity, -800kHz			46		dB
RSSI dynamic range	Starting from the sensitivity limit		86		dB
RSSI accuracy	Starting from the sensitivity limit across the given dynamic range		±3		dB
<b>Wi-SUN, 200kbps, ±50kHz deviation, 2-GFSK, 335kHz RX BW, #4a</b>					
Sensitivity	MRFSK, 918.4MHz, 10% PER, 250 byte payload		-99		dBm
Saturation limit	10% PER, 250 byte payload, 918.4MHz		10		dBm
Selectivity, +400kHz	10% PER, 250 byte payload, 918.4MHz. Wanted signal 3dB above sensitivity level.		42		dB
Selectivity, -400kHz			40		dB
Selectivity, +800kHz			51		dB
Selectivity, -800kHz			47		dB
RSSI dynamic range	Starting from the sensitivity limit		91		dB
RSSI accuracy	Starting from the sensitivity limit across the given dynamic range		±3		dB
<b>Wi-SUN, 200kbps, ±100kHz deviation, 2-GFSK, 416kHz RX BW, #4b</b>					
Sensitivity	MRFSK, 920.8MHz, 10% PER, 250 byte payload		-98		dBm
Saturation limit	10% PER, 250 byte payload, 920.8MHz		10		dBm

## 7.10 861MHz to 1054MHz—Receive (RX) (continued)

When measured on the LP-EM-CC1354P10-1 reference design with  $T_c = 25^\circ\text{C}$ ,  $V_{\text{DDS}} = 3.0\text{V}$  with DC/DC enabled unless otherwise noted. All measurements are performed at the antenna input with a combined RX and TX path. All measurements are performed conducted.

PARAMETER	TEST CONDITIONS	MIN	TYP	MAX	UNIT	
Selectivity, +600kHz	10% PER, 250 byte payload, 920.8MHz. Wanted signal 3dB above sensitivity level, modulated blocker.		46		dB	
Selectivity, -600kHz			43		dB	
Selectivity, +1200kHz			54		dB	
Selectivity, -1200kHz			51		dB	
RSSI dynamic range	Starting from the sensitivity limit		86		dB	
RSSI accuracy	Starting from the sensitivity limit across the given dynamic range		±3		dB	
<b>Wi-SUN, 300kbps, ±75kHz deviation, 2-GFSK, 496kHz RX BW, #5</b>						
Sensitivity	MRFSK, 917.6MHz, 10% PER, 250 byte payload		-97		dBm	
Saturation limit	10% PER, 250 byte payload, 917.6MHz		10		dBm	
Selectivity, +600kHz	10% PER, 250 byte payload, 917.6MHz. Wanted signal 3dB above sensitivity level.		42		dB	
Selectivity, -600kHz			37		dB	
Selectivity, +1200kHz			51		dB	
Selectivity, -1200kHz			40		dB	
RSSI dynamic range	Starting from the sensitivity limit		86		dB	
RSSI accuracy	Starting from the sensitivity limit across the given dynamic range		±3		dB	
<b>802.15.4-2020, 10kbps, ±5kHz deviation, 2-FSK, 26kHz RX BW, Mode #1a</b>						
Sensitivity	FSK, 915.0MHz, 20 byte PSDU < 10% PER		-113		dBm	
Sensitivity	FSK, 868.3MHz, 20 byte PSDU < 10% PER		-113		dBm	
Saturation limit	PSDU length 20 octets; PER < 10%, 868.3MHz		10		dBm	
Selectivity, +50kHz	PSDU length 20 octets; PER < 10%, 868.3MHz		36		dB	
Selectivity, -50kHz			36		dB	
Selectivity, +100kHz			40		dB	
Selectivity, -100kHz			39		dB	
Selectivity, +200kHz			44		dB	
Selectivity, -200kHz			37		dB	
Blocking, +1MHz			60		dB	
Blocking, -1MHz			59		dB	
Blocking, +2MHz			64		dB	
Blocking, -2MHz			64		dB	
Blocking, +5MHz			75		dB	
Blocking, -5MHz			74		dB	
Blocking, +10MHz			79		dB	
Blocking, -10MHz			79		dB	
Blocking + 5% Fc. (45.75MHz)		10% PER, 20 byte payload, 866.6MHz 802.15.4g mandatory mode, wanted signal -94dBm. 3dB above usable sensitivity limit according to ETSI EN 300 220 V3.1.1 (usable sensitivity -97dBm). Limit is Cat 1.5 requirement.		-15		dBm
Blocking - 5% Fc. (-45.75MHz)				-15		dBm
Image rejection (image compensation enabled)	20 byte PSDU < 10% PER, 866.6MHz. Wanted signal 3dB above sensitivity limit.		39		dB	
Image rejection (image compensation enabled)	20 byte PSDU < 10% PER, 866.6MHz <sup>(1)</sup>		39		dB	
RSSI dynamic range	Starting from the sensitivity limit		100		dB	
RSSI accuracy	Starting from the sensitivity limit across the given dynamic range		±3		dB	
Frequency error tolerance (ppm)	10% PER, 20 byte payload, measured at 10dB above sensitivity level. Negative offset		-12		ppm	
Frequency error tolerance (ppm)	10% PER, 20 byte payload, measured at 10dB above sensitivity level. Positive offset		12		ppm	
Symbol rate error tolerance (ppm)	10% PER, 20 byte payload, measured at 10dB above sensitivity level. Negative offset		-1000		ppm	

## 7.10 861MHz to 1054MHz—Receive (RX) (continued)

When measured on the LP-EM-CC1354P10-1 reference design with  $T_c = 25^\circ\text{C}$ ,  $V_{\text{DD5}} = 3.0\text{V}$  with DC/DC enabled unless otherwise noted. All measurements are performed at the antenna input with a combined RX and TX path. All measurements are performed conducted.

PARAMETER	TEST CONDITIONS	MIN	TYP	MAX	UNIT	
Symbol rate error tolerance (ppm)	10% PER, 20 byte payload, measured at 10dB above sensitivity level. Positive offset		1000		ppm	
<b>802.15.4-2020, 20kbps, <math>\pm 10\text{kHz}</math> deviation, 2-FSK, 52 kHz RX BW, Mode #1b</b>						
Sensitivity	FSK, 20kbps, $\pm 10\text{kHz}$ deviation, 2-GFSK, 915.0MHz, 52 kHz RX BW, 20 byte PSDU < 10% PER		-110		dBm	
Sensitivity	FSK, 20kbps, $\pm 10\text{kHz}$ deviation, 2-GFSK, 868.3MHz, 52 kHz RX BW, 20 byte PSDU < 10% PER		-110		dBm	
Saturation limit	20 byte PSDU < 10% PER, 868.3MHz		10		dBm	
Selectivity, +100kHz	20-byte PSDU < 10% PER, 868.3MHz		38		dB	
Selectivity, -100kHz			36		dB	
Selectivity, +200kHz			44		dB	
Selectivity, -200kHz			42		dB	
Selectivity, +400kHz			49		dB	
Selectivity, -400kHz			44		dB	
Blocking, +1MHz			58		dB	
Blocking, -1MHz			54		dB	
Blocking, -2MHz			61		dB	
Blocking, +2MHz			61		dB	
Blocking, -5MHz			70		dB	
Blocking, +5MHz			70		dB	
Blocking, -10MHz			75		dB	
Blocking, +10MHz			76		dB	
Blocking + 5% Fc. (45.75MHz)		20 byte PSDU < 10% PER, 866.6MHz, wanted signal -94dBm. 3dB above usable sensitivity limit according to ETSI EN 300 220 V3.1.1 (usable sensitivity -97dBm). Limit is Cat 1.5 requirement.		-13		dBm
Blocking - 5% Fc. (-45.75MHz)				-13		dBm
Image rejection (image compensation enabled)	20 byte PSDU < 10% PER, 866.6MHz. Wanted signal 3dB above sensitivity limit.		39		dB	
Image rejection (image compensation enabled)	20 byte PSDU < 10% PER, 866.6MHz <sup>(1)</sup>		39		dB	
RSSI dynamic range	Starting from the sensitivity limit		100		dB	
RSSI accuracy	Starting from the sensitivity limit across the given dynamic range		$\pm 3$		dB	
Frequency error tolerance (ppm)	10% PER, 20 byte payload, measured at 10dB above sensitivity level. Negative offset		24		ppm	
Frequency error tolerance (ppm)	10% PER, 20 byte payload, measured at 10dB above sensitivity level. Positive offset		24		ppm	
Symbol rate error tolerance (ppm)	10% PER, 20 byte payload, measured at 10dB above sensitivity level. Negative offset		-1000		ppm	
Symbol rate error tolerance (ppm)	10% PER, 20 byte payload, measured at 10dB above sensitivity level. Positive offset		1000		ppm	
<b>802.15.4, 200kbps, <math>\pm 50\text{kHz}</math> deviation, 2-GFSK, 311kHz RX BW</b>						
Sensitivity	1% BER, 868MHz		-103		dBm	
Sensitivity	1% BER, 915MHz		-103		dBm	
Selectivity, +400kHz	1% BER, 915MHz. Wanted signal 3dB above sensitivity limit.		45		dB	
Selectivity, -400kHz	1% BER, 915MHz. Wanted signal 3dB above sensitivity limit.		45		dB	
Selectivity, +800kHz	1% BER, 915MHz. Wanted signal 3dB above sensitivity limit.		52		dB	
Selectivity, -800kHz	1% BER, 915MHz. Wanted signal 3dB above sensitivity limit.		47		dB	
Blocking, +2MHz	1% BER, 915MHz. Wanted signal 3dB above sensitivity limit.		59		dB	

## 7.10 861MHz to 1054MHz—Receive (RX) (continued)

When measured on the LP-EM-CC1354P10-1 reference design with  $T_c = 25^\circ\text{C}$ ,  $V_{\text{DDS}} = 3.0\text{V}$  with DC/DC enabled unless otherwise noted. All measurements are performed at the antenna input with a combined RX and TX path. All measurements are performed conducted.

PARAMETER	TEST CONDITIONS	MIN	TYP	MAX	UNIT
Blocking, -2MHz	1% BER, 915MHz. Wanted signal 3dB above sensitivity limit.		56		dB
Blocking, +10MHz	1% BER, 915MHz. Wanted signal 3dB above sensitivity limit.		71		dB
Blocking, -10MHz	1% BER, 915MHz. Wanted signal 3dB above sensitivity limit.		70		dB
<b>802.15.4, 500kbps, ±190kHz deviation, 2-GFSK, 622 kHz RX BW</b>					
Sensitivity 500kbps	915MHz, 1% PER, 127 byte payload		-95		dBm
Selectivity, ±1MHz	915MHz, 1% PER, 127 byte payload. Wanted signal at -88dBm		34		dB
Selectivity, ±2MHz	915MHz, 1% PER, 127 byte payload. Wanted signal at -88dBm		46		dB
Co-channel rejection	915MHz, 1% PER, 127 byte payload. Wanted signal at -71dBm		-8		dB
<b>SimpleLink™ Long Range 2.5/5kbps (20kps), ±5kHz Deviation, 2-GFSK, 34kHz RX Bandwidth, FEC = 1:2, DSSS = 1:4/1:2</b>					
Sensitivity	2.5kbps, 1% BER, 868MHz		-121		dBm
Sensitivity	2.5kbps, 1% BER, 915MHz		-121		dBm
Sensitivity	5kbps, 1% BER, 868MHz		-119		dBm
Sensitivity	5kbps, 1% BER, 915MHz		-119		dBm
Saturation limit	2.5kbps, 1% BER, 868MHz		10		dBm
Selectivity, +100kHz	2.5kbps, 1% BER, 868MHz <sup>(1)</sup>		49		dB
Selectivity, -100kHz	2.5kbps, 1% BER, 868MHz <sup>(1)</sup>		49		dB
Selectivity, +200kHz	2.5kbps, 1% BER, 868MHz <sup>(1)</sup>		52		dB
Selectivity, -200kHz	2.5kbps, 1% BER, 868MHz <sup>(1)</sup>		48		dB
Selectivity, +300kHz	2.5kbps, 1% BER, 868MHz <sup>(1)</sup>		54		dB
Selectivity, -300kHz	2.5kbps, 1% BER, 868MHz <sup>(1)</sup>		48		dB
Blocking, +1MHz	2.5kbps, 1% BER, 868MHz <sup>(1)</sup>		65		dB
Blocking, -1MHz	2.5kbps, 1% BER, 868MHz <sup>(1)</sup>		60		dB
Blocking, +2MHz	2.5kbps, 1% BER, 868MHz <sup>(1)</sup>		70		dB
Blocking, -2MHz	2.5kbps, 1% BER, 868MHz <sup>(1)</sup>		68		dB
Blocking, +5MHz	2.5kbps, 1% BER, 868MHz <sup>(1)</sup>		78		dB
Blocking, -5MHz	2.5kbps, 1% BER, 868MHz <sup>(1)</sup>		77		dB
Blocking, +10MHz	2.5kbps, 1% BER, 868MHz <sup>(1)</sup>		87		dB
Blocking, -10MHz	2.5kbps, 1% BER, 868MHz <sup>(1)</sup>		92		dB
Image rejection (image compensation enabled)	2.5kbps, 1% BER, 868MHz <sup>(1)</sup>		47		dB
RSSI accuracy	Starting from the sensitivity limit across the given dynamic range		±3		dB
Frequency error tolerance (ppm)	2.5kbps, measured at -110dBm.		-24/26		ppm
Symbolrate error tolerance (ppm)	2.5kbps, measured at -110dBm.		-90/70		ppm
<b>Narrowband, 9.6kbps ±2.4kHz Deviation, 2-GFSK, 868MHz, 17.1kHz RX BW</b>					
Sensitivity	1% BER		-117		dBm
Adjacent Channel Rejection	1% BER. Wanted signal 3dB above usable sensitivity limit (usable sensitivity -104.6dBm). Interferer ±20kHz		42		dB
Alternate Channel Rejection	1% BER. Wanted signal 3dB above usable sensitivity limit (usable sensitivity -104.6dBm). Interferer ±40kHz		42		dB
Blocking, ±1MHz	1% BER. Wanted signal 3dB above usable sensitivity limit (usable sensitivity -104.6dBm)		66		dB
Blocking, ±2MHz	1% BER. Wanted signal 3dB above usable sensitivity limit (usable sensitivity -104.6dBm)		71		dB
Blocking, ±10MHz	1% BER. Wanted signal 3dB above usable sensitivity limit (usable sensitivity -104.6dBm)		85		dB
<b>802.15.4, 50kbps, ±25kHz Deviation, 2-GFSK, 100kHz RX BW (Legacy)</b>					
Sensitivity	1% BER, 868MHz		-110		dBm
Sensitivity	1% BER, 915MHz		-110		dBm
Saturation limit	1% BER, 868MHz		10		dBm

## 7.10 861MHz to 1054MHz—Receive (RX) (continued)

When measured on the LP-EM-CC1354P10-1 reference design with  $T_c = 25^\circ\text{C}$ ,  $V_{\text{DD5}} = 3.0\text{V}$  with DC/DC enabled unless otherwise noted. All measurements are performed at the antenna input with a combined RX and TX path. All measurements are performed conducted.

PARAMETER	TEST CONDITIONS	MIN	TYP	MAX	UNIT	
Selectivity, +200kHz	1% BER, 868MHz <sup>(1)</sup>		44		dB	
Selectivity, -200kHz			44		dB	
Selectivity, +400kHz			54		dB	
Selectivity, -400kHz			44		dB	
Blocking, +1MHz			57		dB	
Blocking, -1MHz			57		dB	
Blocking, +2MHz			61		dB	
Blocking, -2MHz			61		dB	
Blocking, +5MHz			67		dB	
Blocking, -5MHz			67		dB	
Blocking, +10MHz			76		dB	
Blocking, -10MHz			76		dB	
Blocking + 5% Fc. (43.42MHz)		1% BER, 868MHz		-15		dBm
Blocking - 5% Fc. (-43.42MHz)		802.15.4g mandatory mode, wanted signal -94dBm. 3dB above usable sensitivity limit according to ETSI EN 300 220 V3.1.1 (usable sensitivity -97dBm). Limit is Cat 1.5 requirement.		-15		dBm
Image rejection (image compensation enabled)	1% BER, 868MHz. Wanted signal 3dB above sensitivity limit		39		dB	
RSSI dynamic range	Starting from the sensitivity limit		95		dB	
RSSI accuracy	Starting from the sensitivity limit across the given dynamic range		±3		dB	
Frequency error tolerance (ppm)	1% BER, measured at -100dBm (10dB above sensitivity level). Negative offset		-30		ppm	
Frequency error tolerance (ppm)	1% BER, measured at -100dBm (10dB above sensitivity level). Positive offset		25		ppm	
Symbol rate error tolerance (ppm)	1% BER, measured at -100dBm (10dB above sensitivity level). Negative offset		-2000		ppm	
Symbol rate error tolerance (ppm)	1% BER, measured at -100dBm (10dB above sensitivity level) Positive offset		2000		ppm	
<b>802.15.4, 100kbps, ±25kHz Deviation, 2-GFSK, 137kHz RX BW</b>						
Sensitivity 100kbps	868MHz, 1% PER, 127 byte payload		-103		dBm	
Selectivity, ±200kHz	868MHz, 1% PER, 127 byte payload. Wanted signal at -96dBm		38		dB	
Selectivity, ±400kHz			44		dB	
Co-channel rejection	868MHz, 1% PER, 127 byte payload. Wanted signal at -79dBm		-9		dB	
<b>Generic OOK (16.384kbps, OOK w / Manchester encoding, 100kHz RX BW)</b>						
Sensitivity	OOK, 915.0MHz, 1% BER		-114		dBm	
Sensitivity	OOK, 868.8MHz, 1% BER		-113		dBm	
Saturation limit	868.3MHz		0		dBm	
Selectivity, +200kHz	868.3MHz. Wanted signal 3dB above sensitivity level.		52		dB	
Selectivity, -200kHz			47		dB	
Selectivity, +400kHz			42		dB	
Selectivity, -400kHz			42		dB	
Blocking, +1MHz			68		dB	
Blocking, -1MHz			64		dB	
Blocking, +2MHz			68		dB	
Blocking, -2MHz			64		dB	
Blocking, +5MHz			74		dB	
Blocking, -5MHz			73		dB	
Blocking, +10MHz			68		dB	
Blocking, -10MHz			64		dB	

## 7.10 861MHz to 1054MHz—Receive (RX) (continued)

When measured on the LP-EM-CC1354P10-1 reference design with  $T_c = 25^\circ\text{C}$ ,  $V_{\text{DD5}} = 3.0\text{V}$  with DC/DC enabled unless otherwise noted. All measurements are performed at the antenna input with a combined RX and TX path. All measurements are performed conducted.

PARAMETER	TEST CONDITIONS	MIN	TYP	MAX	UNIT
RSSI dynamic range	Starting from the sensitivity limit		95		dB
RSSI accuracy	Starting from the sensitivity limit across the given dynamic range		±3		dB
Frequency tolerance (ppm)	Measured at 10dB above sensitivity level. Negative offset		-40		ppm
Frequency error tolerance (ppm)	Measured at 10dB above sensitivity level. Positive offset		40		ppm
Symbol rate error tolerance (ppm)	Measured at 10dB above sensitivity level. Negative offset		-2000		ppm
Symbol rate error tolerance (ppm)	Measured at 10dB above sensitivity level Positive offset		2000		ppm
<b>WB-DSSS, 240/120/60/30kbps (480ksym/s, 2-GFSK, ±195kHz Deviation, FEC (Half Rate), DSSS = 1/2/4/8, 622 kHz RX BW)</b>					
Sensitivity	240kbps, DSSS = 1, 1% BER, 915.0MHz		-105		dBm
Sensitivity	120kbps, DSSS = 2, 1% BER, 915.0MHz		-106		dBm
Sensitivity	60kbps, DSSS = 4, 1% BER, 915.0MHz		-108		dBm
Sensitivity	30kbps, DSSS = 8, 1% BER, 915.0MHz		-109		dBm
Saturation limit	915.0MHz		0		dBm
Blocking +1MHz	240kbps, DSSS = 1		54		dB
	120kbps, DSSS = 2		57		dB
	60kbps, DSSS = 4		57		dB
	30kbps, DSSS = 8		57		dB
Blocking -1MHz	240kbps, DSSS = 1		49		dB
	120kbps, DSSS = 2		50		dB
	60kbps, DSSS = 4		52		dB
	30kbps, DSSS = 8		53		dB
Blocking +2MHz	240kbps, DSSS = 1		54		dB
	120kbps, DSSS = 2		55		dB
	60kbps, DSSS = 4		57		dB
	30kbps, DSSS = 8		58		dB
Blocking -2MHz	240kbps, DSSS = 1		53		dB
	120kbps, DSSS = 2		54		dB
	60kbps, DSSS = 4		56		dB
	30kbps, DSSS = 8		56		dB
Blocking +5MHz	240kbps, DSSS = 1		55		dB
	120kbps, DSSS = 2		56		dB
	60kbps, DSSS = 4		58		dB
	30kbps, DSSS = 8		59		dB
Blocking -5MHz	240kbps, DSSS = 1		54		dB
	120kbps, DSSS = 2		55		dB
	60kbps, DSSS = 4		57		dB
	30kbps, DSSS = 8		58		dB
Blocking +10MHz	240kbps, DSSS = 1		69		dB
	120kbps, DSSS = 2		70		dB
	60kbps, DSSS = 4		72		dB
	30kbps, DSSS = 8		73		dB
Blocking -10MHz	240kbps, DSSS = 1		65		dB
	120kbps, DSSS = 2		67		dB
	60kbps, DSSS = 4		69		dB
	30kbps, DSSS = 8		70		dB
RSSI dynamic range	Starting from the sensitivity limit		85		dB

## 7.10 861MHz to 1054MHz—Receive (RX) (continued)

When measured on the LP-EM-CC1354P10-1 reference design with  $T_c = 25^\circ\text{C}$ ,  $V_{\text{DDS}} = 3.0\text{V}$  with DC/DC enabled unless otherwise noted. All measurements are performed at the antenna input with a combined RX and TX path. All measurements are performed conducted.

PARAMETER	TEST CONDITIONS	MIN	TYP	MAX	UNIT
RSSI accuracy	Starting from the sensitivity limit across the given dynamic range		±3		dB

(1) Wanted signal 3dB above usable sensitivity limit according to ETSI EN 300 220 v. 3.1.1

## 7.11 861MHz to 1054MHz—Transmit (TX)

When measured on the LP-EM-CC1354P10-1 reference design with  $T_c = 25^\circ\text{C}$ ,  $V_{\text{DDS}} = 3.0\text{V}$  with DC/DC enabled unless otherwise noted. All measurements are performed at the antenna input with a combined RX and TX path. All measurements are performed conducted. <sup>(1)</sup>

PARAMETER	TEST CONDITIONS	MIN	TYP	MAX	UNIT
<b>General parameters</b>					
Max output power, boost mode Sub-1GHz PA <sup>(2)</sup>	VDDR = 1.95V Minimum supply voltage (VDDS ) for boost mode is 2.1V 868MHz and 915MHz		14		dBm
Max output power, Sub-1GHz PA <sup>(2)</sup>	868MHz and 915MHz		12		dBm
Output power programmable range Sub-1GHz PA	868MHz and 915MHz, 1dB step size.		34		dB
Output power variation over temperature Sub-1GHz PA	+10dBm setting Over recommended temperature operating range		±2		dB
Output power variation over temperature Boost mode, Sub-1GHz PA	+14dBm setting Over recommended temperature operating range		±1.5		dB
<b>Spurious emissions and harmonics</b>					
Spurious emissions (excluding harmonics) Sub-1GHz PA, 868MHz <sup>(3)</sup>	30MHz to 1GHz	+14dBm setting ETSI restricted bands	< -54		dBm
		+14dBm setting ETSI outside restricted bands	< -36		dBm
	1GHz to 12.75GHz (outside ETSI restricted bands)	+14dBm setting measured in 1MHz bandwidth (ETSI)	< -30		dBm
Spurious emissions out-of-band Sub-1GHz PA, 915MHz <sup>(3)</sup>	30MHz to 88MHz (within FCC restricted bands)	+14dBm setting	< -56		dBm
	88MHz to 216MHz (within FCC restricted bands)	+14dBm setting	< -52		dBm
	216MHz to 960MHz (within FCC restricted bands)	+14dBm setting	< -50		dBm
	960MHz to 2390MHz and above 2483.5MHz (within FCC restricted band)	+14dBm setting	< -42		dBm
	1GHz to 12.75GHz (outside FCC restricted bands)	+14dBm setting	< -40		dBm
Spurious emissions out-of-band Sub-1GHz PA, 920.6/928MHz <sup>(3)</sup>	Below 710MHz (ARIB T-108)	+14dBm setting	< -36		dBm
	710MHz to 900MHz (ARIB T-108)	+14dBm setting	< -55		dBm
	900MHz to 915MHz (ARIB T-108)	+14dBm setting	< -55		dBm
	930MHz to 1000MHz (ARIB T-108)	+14dBm setting	< -55		dBm
	1000MHz to 1215MHz (ARIB T-108)	+14dBm setting	< -45		dBm
	Above 1215 MHz (ARIB T-108)	+14dBm setting	< -30		dBm

### 7.11 861MHz to 1054MHz—Transmit (TX) (continued)

When measured on the LP-EM-CC1354P10-1 reference design with  $T_c = 25^\circ\text{C}$ ,  $V_{\text{DDS}} = 3.0\text{V}$  with DC/DC enabled unless otherwise noted. All measurements are performed at the antenna input with a combined RX and TX path. All measurements are performed conducted. <sup>(1)</sup>

PARAMETER		TEST CONDITIONS	MIN	TYP	MAX	UNIT
Harmonics Sub-1GHz PA	Second harmonic	+14dBm setting, 868MHz		< -30		dBm
		+14dBm setting, 915MHz		< -30		
	Third harmonic	+14dBm setting, 868MHz		< -30		dBm
		+14dBm setting, 915MHz		< -42		
	Fourth harmonic	+14dBm setting, 868MHz		< -30		dBm
		+14dBm setting, 915MHz		< -42		
	Fifth harmonic	+14dBm setting, 868MHz		< -30		dBm
		+14dBm setting, 915MHz		< -42		

- (1) Some combinations of frequency, data rate and modulation format requires use of external crystal load capacitors for regulatory compliance. More details can be found in the device errata.
- (2) Output power is dependent on RF match. For dual-band devices in the CC13X4 platform, output power might be slightly reduced depending on RF layout trade-offs.
- (3) Suitable for systems targeting compliance with EN 300 220, EN 303 131, EN 303 204, FCC CFR47 Part 15, ARIB STD-T108.

### 7.12 861MHz to 1054MHz - PLL Phase Noise Wideband Mode

When measured on the LP-EM-CC1354P10-1 reference design with  $T_c = 25^\circ\text{C}$ ,  $V_{\text{DDS}} = 3.0\text{V}$ .

PARAMETER	TEST CONDITIONS	MIN	TYP	MAX	UNIT
Phase noise in the 868- and 915-MHz bands 20kHz PLL loop bandwidth	±10kHz offset		-74		dBc/Hz
	±100kHz offset		-97		dBc/Hz
	±200kHz offset		-107		dBc/Hz
	±400kHz offset		-113		dBc/Hz
	±1000kHz offset		-120		dBc/Hz
	±2000kHz offset		-127		dBc/Hz
	±10000kHz offset		-141		dBc/Hz

### 7.13 861MHz to 1054MHz - PLL Phase Noise Narrowband Mode

When measured on the LP-EM-CC1354P10-1 reference design with  $T_c = 25^\circ\text{C}$ ,  $V_{\text{DDS}} = 3.0\text{V}$ .

PARAMETER	TEST CONDITIONS	MIN	TYP	MAX	UNIT
Phase noise in the 868- and 915-MHz bands 150kHz PLL loop bandwidth	±10kHz offset		-96		dBc/Hz
	±100kHz offset		-95		dBc/Hz
	±200kHz offset		-94		dBc/Hz
	±400kHz offset		-104		dBc/Hz
	±1000kHz offset		-121		dBc/Hz
	±2000kHz offset		-130		dBc/Hz
	±10000kHz offset		-140		dBc/Hz

### 7.14 Bluetooth Low Energy—Receive (RX)

When measured on the LP-EM-CC1354P10-1 reference design with  $T_c = 25^\circ\text{C}$ ,  $V_{\text{DDS}} = 3.0\text{V}$ ,  $f_{\text{RF}} = 2440\text{MHz}$  with DC/DC enabled unless otherwise noted. All measurements are performed at the antenna input with a combined RX and TX path. All measurements are performed conducted.

PARAMETER	TEST CONDITIONS	MIN	TYP	MAX	UNIT
<b>125kbps (LE Coded)</b>					
Receiver sensitivity	Differential mode. BER = $10^{-3}$		-105		dBm
Receiver saturation	Differential mode. BER = $10^{-3}$		>5		dBm

## 7.14 Bluetooth Low Energy—Receive (RX) (continued)

When measured on the LP-EM-CC1354P10-1 reference design with  $T_c = 25^\circ\text{C}$ ,  $V_{\text{DD5}} = 3.0\text{V}$ ,  $f_{\text{RF}} = 2440\text{MHz}$  with DC/DC enabled unless otherwise noted. All measurements are performed at the antenna input with a combined RX and TX path. All measurements are performed conducted.

PARAMETER	TEST CONDITIONS	MIN	TYP	MAX	UNIT
Frequency error tolerance	Difference between the incoming carrier frequency and the internally generated carrier frequency		> (-300 / 300)		kHz
Data rate error tolerance	Difference between incoming data rate and the internally generated data rate (37-byte packets)		> (-320 / 240)		ppm
Data rate error tolerance	Difference between incoming data rate and the internally generated data rate (255-byte packets)		> (-100 / 125)		ppm
Co-channel rejection <sup>(1)</sup>	Wanted signal at -79dBm, modulated interferer in channel, BER = $10^{-3}$		-1.5		dB
Selectivity, $\pm 1\text{MHz}$ <sup>(1)</sup>	Wanted signal at -79dBm, modulated interferer at $\pm 1\text{MHz}$ , BER = $10^{-3}$		8 / 4.5 <sup>(2)</sup>		dB
Selectivity, $\pm 2\text{MHz}$ <sup>(1)</sup>	Wanted signal at -79dBm, modulated interferer at $\pm 2\text{MHz}$ , BER = $10^{-3}$		44 / 39 <sup>(2)</sup>		dB
Selectivity, $\pm 3\text{MHz}$ <sup>(1)</sup>	Wanted signal at -79dBm, modulated interferer at $\pm 3\text{MHz}$ , BER = $10^{-3}$		43 / 43 <sup>(2)</sup>		dB
Selectivity, $\pm 4\text{MHz}$ <sup>(1)</sup>	Wanted signal at -79dBm, modulated interferer at $\pm 4\text{MHz}$ , BER = $10^{-3}$		44 / 43 <sup>(2)</sup>		dB
Selectivity, $\pm 6\text{MHz}$ <sup>(1)</sup>	Wanted signal at -79dBm, modulated interferer at $\geq \pm 6\text{MHz}$ , BER = $10^{-3}$		48 / 43 <sup>(2)</sup>		dB
Selectivity, $\pm 7\text{MHz}$	Wanted signal at -79dBm, modulated interferer at $\geq \pm 7\text{MHz}$ , BER = $10^{-3}$		51 / 45 <sup>(2)</sup>		dB
Selectivity, Image frequency <sup>(1)</sup>	Wanted signal at -79dBm, modulated interferer at image frequency, BER = $10^{-3}$		39		dB
Selectivity, Image frequency $\pm 1\text{MHz}$ <sup>(1)</sup>	Note that Image frequency + 1MHz is the Co- channel -1MHz. Wanted signal at -79dBm, modulated interferer at $\pm 1\text{MHz}$ from image frequency, BER = $10^{-3}$		4.5 / 44 <sup>(2)</sup>		dB
RSSI Range			89		dB
RSSI Accuracy (+/-)			$\pm 4$		dB
<b>500kbps (LE Coded)</b>					
Receiver sensitivity	Differential mode. BER = $10^{-3}$		-100		dBm
Receiver saturation	Differential mode. BER = $10^{-3}$		> 5		dBm
Frequency error tolerance	Difference between the incoming carrier frequency and the internally generated carrier frequency		> (-300 / 300)		kHz
Data rate error tolerance	Difference between incoming data rate and the internally generated data rate (37-byte packets)		> (-450 / 450)		ppm
Data rate error tolerance	Difference between incoming data rate and the internally generated data rate (255-byte packets)		> (-175 / 175)		ppm
Co-channel rejection <sup>(1)</sup>	Wanted signal at -72dBm, modulated interferer in channel, BER = $10^{-3}$		-3.5		dB
Selectivity, $\pm 1\text{MHz}$ <sup>(1)</sup>	Wanted signal at -72dBm, modulated interferer at $\pm 1\text{MHz}$ , BER = $10^{-3}$		8 / 4 <sup>(2)</sup>		dB
Selectivity, $\pm 2\text{MHz}$ <sup>(1)</sup>	Wanted signal at -72dBm, modulated interferer at $\pm 2\text{MHz}$ , BER = $10^{-3}$		41 / 37 <sup>(2)</sup>		dB
Selectivity, $\pm 3\text{MHz}$ <sup>(1)</sup>	Wanted signal at -72dBm, modulated interferer at $\pm 3\text{MHz}$ , BER = $10^{-3}$		44 / 41 <sup>(2)</sup>		dB
Selectivity, $\pm 4\text{MHz}$ <sup>(1)</sup>	Wanted signal at -72dBm, modulated interferer at $\pm 4\text{MHz}$ , BER = $10^{-3}$		44 / 43 <sup>(2)</sup>		dB
Selectivity, $\pm 6\text{MHz}$ <sup>(1)</sup>	Wanted signal at -72dBm, modulated interferer at $\geq \pm 6\text{MHz}$ , BER = $10^{-3}$		46 / 43 <sup>(2)</sup>		dB
Selectivity, $\pm 7\text{MHz}$	Wanted signal at -72dBm, modulated interferer at $\geq \pm 7\text{MHz}$ , BER = $10^{-3}$		49 / 45 <sup>(2)</sup>		dB
Selectivity, Image frequency <sup>(1)</sup>	Wanted signal at -72dBm, modulated interferer at image frequency, BER = $10^{-3}$		37		dB
Selectivity, Image frequency $\pm 1\text{MHz}$ <sup>(1)</sup>	Note that Image frequency + 1MHz is the Co- channel -1MHz. Wanted signal at -72dBm, modulated interferer at $\pm 1\text{MHz}$ from image frequency, BER = $10^{-3}$		4 / 46 <sup>(2)</sup>		dB

## 7.14 Bluetooth Low Energy—Receive (RX) (continued)

When measured on the LP-EM-CC1354P10-1 reference design with  $T_c = 25^\circ\text{C}$ ,  $V_{\text{DD5}} = 3.0\text{V}$ ,  $f_{\text{RF}} = 2440\text{MHz}$  with DC/DC enabled unless otherwise noted. All measurements are performed at the antenna input with a combined RX and TX path. All measurements are performed conducted.

PARAMETER	TEST CONDITIONS	MIN	TYP	MAX	UNIT
RSSI Range			85		dB
RSSI Accuracy (+/-)			±4		dB
<b>1 Mbps (LE 1M)</b>					
Receiver sensitivity	Differential mode. BER = $10^{-3}$		-97		dBm
Receiver saturation	Differential mode. BER = $10^{-3}$		> 5		dBm
Frequency error tolerance	Difference between the incoming carrier frequency and the internally generated carrier frequency		> (-350 / 350)		kHz
Data rate error tolerance	Difference between incoming data rate and the internally generated data rate (37-byte packets)		> (-750 / 750)		ppm
Co-channel rejection <sup>(1)</sup>	Wanted signal at -67dBm, modulated interferer in channel, BER = $10^{-3}$		-6		dB
Selectivity, ±1MHz <sup>(1)</sup>	Wanted signal at -67dBm, modulated interferer at ±1MHz, BER = $10^{-3}$		7 / 4 <sup>(2)</sup>		dB
Selectivity, ±2MHz <sup>(1)</sup>	Wanted signal at -67dBm, modulated interferer at ±2MHz, BER = $10^{-3}$		40 / 33 <sup>(2)</sup>		dB
Selectivity, ±3MHz <sup>(1)</sup>	Wanted signal at -67dBm, modulated interferer at ±3MHz, BER = $10^{-3}$		36 / 41 <sup>(2)</sup>		dB
Selectivity, ±4MHz <sup>(1)</sup>	Wanted signal at -67dBm, modulated interferer at ±4MHz, BER = $10^{-3}$		36 / 45 <sup>(2)</sup>		dB
Selectivity, ±5MHz or more <sup>(1)</sup>	Wanted signal at -67dBm, modulated interferer at ≥ ±5MHz, BER = $10^{-3}$		40		dB
Selectivity, image frequency <sup>(1)</sup>	Wanted signal at -67dBm, modulated interferer at image frequency, BER = $10^{-3}$		33		dB
Selectivity, image frequency ±1MHz <sup>(1)</sup>	Note that Image frequency + 1MHz is the Co- channel -1MHz. Wanted signal at -67dBm, modulated interferer at ±1MHz from image frequency, BER = $10^{-3}$		4 / 41 <sup>(2)</sup>		dB
Out-of-band blocking <sup>(3)</sup>	30MHz to 2000MHz		-10		dBm
Out-of-band blocking	2003MHz to 2399MHz		-18		dBm
Out-of-band blocking	2484MHz to 2997MHz		-12		dBm
Out-of-band blocking	3000MHz to 12.75GHz		-2		dBm
Intermodulation	Wanted signal at 2402MHz, -64dBm. Two interferers at 2405 and 2408MHz respectively, at the given power level		-42		dBm
Spurious emissions, 30 to 1000MHz <sup>(4)</sup>	Measurement in a 50 Ω single-ended load.		< -59		dBm
Spurious emissions, 1 to 12.75GHz <sup>(4)</sup>	Measurement in a 50 Ω single-ended load.		< -47		dBm
RSSI dynamic range			70		dB
RSSI accuracy			±4		dB
<b>2 Mbps (LE 2M)</b>					
Receiver sensitivity	Differential mode. Measured at SMA connector, BER = $10^{-3}$		-92		dBm
Receiver saturation	Differential mode. Measured at SMA connector, BER = $10^{-3}$		> 5		dBm
Frequency error tolerance	Difference between the incoming carrier frequency and the internally generated carrier frequency		> (-500 / 500)		kHz
Data rate error tolerance	Difference between incoming data rate and the internally generated data rate (37-byte packets)		> (-700 / 750)		ppm
Co-channel rejection <sup>(1)</sup>	Wanted signal at -67dBm, modulated interferer in channel, BER = $10^{-3}$		-7		dB
Selectivity, ±2MHz <sup>(1)</sup>	Wanted signal at -67dBm, modulated interferer at ±2MHz, Image frequency is at -2MHz, BER = $10^{-3}$		8 / 4 <sup>(2)</sup>		dB
Selectivity, ±4MHz <sup>(1)</sup>	Wanted signal at -67dBm, modulated interferer at ±4MHz, BER = $10^{-3}$		35 / 32 <sup>(2)</sup>		dB

## 7.14 Bluetooth Low Energy—Receive (RX) (continued)

When measured on the LP-EM-CC1354P10-1 reference design with  $T_c = 25^\circ\text{C}$ ,  $V_{\text{DDS}} = 3.0\text{V}$ ,  $f_{\text{RF}} = 2440\text{MHz}$  with DC/DC enabled unless otherwise noted. All measurements are performed at the antenna input with a combined RX and TX path. All measurements are performed conducted.

PARAMETER	TEST CONDITIONS	MIN	TYP	MAX	UNIT
Selectivity, $\pm 6\text{MHz}^{(1)}$	Wanted signal at $-67\text{dBm}$ , modulated interferer at $\pm 6\text{MHz}$ , BER = $10^{-3}$		37 / 34 <sup>(2)</sup>		dB
Selectivity, image frequency <sup>(1)</sup>	Wanted signal at $-67\text{dBm}$ , modulated interferer at image frequency, BER = $10^{-3}$		4		dB
Selectivity, image frequency $\pm 2\text{MHz}^{(1)}$	Note that Image frequency + 2MHz is the Co-channel. Wanted signal at $-67\text{dBm}$ , modulated interferer at $\pm 2\text{MHz}$ from image frequency, BER = $10^{-3}$		-7 / 36 <sup>(2)</sup>		dB
Out-of-band blocking <sup>(3)</sup>	30MHz to 2000MHz		-16		dBm
Out-of-band blocking	2003MHz to 2399MHz		-21		dBm
Out-of-band blocking	2484MHz to 2997MHz		-15		dBm
Out-of-band blocking	3000MHz to 12.75GHz		-20		dBm
Intermodulation	Wanted signal at 2402MHz, $-64\text{dBm}$ . Two interferers at 2408 and 2414MHz respectively, at the given power level		-37		dBm
RSSI Range			64		dB
RSSI Accuracy (+/-)			$\pm 4$		dB

(1) Numbers given as I/C dB.

(2) X / Y, where X is +N MHz and Y is -N MHz.

(3) Excluding one exception at  $F_{\text{wanted}} / 2$ , per Bluetooth Specification.

(4) Suitable for systems targeting compliance with worldwide radio-frequency regulations ETSI EN 300 328 and EN 300 440 Class 2 (Europe), FCC CFR47 Part 15 (US), and ARIB STD-T66 (Japan).

## 7.15 Bluetooth Low Energy—Transmit (TX)

When measured on the LP-EM-CC1354P10-1 reference design with  $T_c = 25^\circ\text{C}$ ,  $V_{\text{DDS}} = 3.0\text{V}$ ,  $f_{\text{RF}} = 2440\text{MHz}$  with DC/DC enabled unless otherwise noted. All measurements are performed at the antenna input with a combined RX and TX path. All measurements are performed conducted.

PARAMETER	TEST CONDITIONS	MIN	TYP	MAX	UNIT
<b>General Parameters</b>					
Max output power, 2.4GHz PA	Differential mode, delivered to a single-ended 50Ω load through a balun		5		dBm
Output power programmable range, 2.4GHz PA	Differential mode, delivered to a single-ended 50Ω load through a balun		26		dB
<b>Spurious emissions and harmonics</b>					
Spurious emissions, 2.4GHz PA	f < 1GHz, outside restricted bands	+5dBm setting	< -36		dBm
	f < 1GHz, restricted bands ETSI		< -54		dBm
	f < 1GHz, restricted bands FCC		< -55		dBm
	f > 1GHz, including harmonics		< -42		dBm
Harmonics, 2.4GHz PA	Second harmonic		< -42		dBm
	Third harmonic	< -42		dBm	

## 7.16 Zigbee and Thread - IEEE 802.15.4-2006 2.4GHz (OQPSK DSSS1:8, 250kbps) - RX

When measured on the LP-EM-CC1354P10-1 reference design with  $T_c = 25^\circ\text{C}$ ,  $V_{\text{DDS}} = 3.0\text{V}$ ,  $f_{\text{RF}} = 2440\text{MHz}$  with DC/DC enabled unless otherwise noted. All measurements are performed at the antenna input with a combined RX and TX path. All measurements are performed conducted.

PARAMETER	TEST CONDITIONS	MIN	TYP	MAX	UNIT
<b>General Parameters</b>					
Receiver sensitivity	Coherent mode PER = 1%		-105		dBm

## 7.16 Zigbee and Thread - IEEE 802.15.4-2006 2.4GHz (OQPSK DSSS1:8, 250kbps) - RX (continued)

When measured on the LP-EM-CC1354P10-1 reference design with  $T_c = 25^\circ\text{C}$ ,  $V_{\text{DDS}} = 3.0\text{V}$ ,  $f_{\text{RF}} = 2440\text{MHz}$  with DC/DC enabled unless otherwise noted. All measurements are performed at the antenna input with a combined RX and TX path. All measurements are performed conducted.

PARAMETER	TEST CONDITIONS	MIN	TYP	MAX	UNIT
Receiver saturation	PER = 1%		> -10		dBm
Adjacent channel rejection	Wanted signal at -82dBm, modulated interferer at $\pm 5\text{MHz}$ , PER = 1%		36		dB
Alternate channel rejection	Wanted signal at -82dBm, modulated interferer at $\pm 10\text{MHz}$ , PER = 1%		55		dB
Channel rejection, $\pm 15\text{MHz}$ or more	Wanted signal at -82dBm, undesired signal is IEEE 802.15.4 modulated channel, stepped through all channels 2405 to 2480MHz, PER = 1%		59		dB
Blocking and desensitization, 5MHz from upper band edge	Wanted signal at 3 dB above the sensitivity level, CW jammer, PER = 1%		57		dB
Blocking and desensitization, 10MHz from upper band edge	Wanted signal at 3 dB above the sensitivity level, CW jammer, PER = 1%		62		dB
Blocking and desensitization, 20MHz from upper band edge	Wanted signal at 3 dB above the sensitivity level, CW jammer, PER = 1%		62		dB
Blocking and desensitization, 50MHz from upper band edge	Wanted signal at 3 dB above the sensitivity level, CW jammer, PER = 1%		65		dB
Blocking and desensitization, -5MHz from lower band edge	Wanted signal at 3 dB above the sensitivity level, CW jammer, PER = 1%		60		dB
Blocking and desensitization, -10MHz from lower band edge	Wanted signal at 3 dB above the sensitivity level, CW jammer, PER = 1%		60		dB
Blocking and desensitization, -20MHz from lower band edge	Wanted signal at 3 dB above the sensitivity level, CW jammer, PER = 1%		60		dB
Blocking and desensitization, -50MHz from lower band edge	Wanted signal at 3 dB above the sensitivity level, CW jammer, PER = 1%		62		dB
Spurious emissions, 30MHz to 1000MHz	Measurement in a 50 $\Omega$ single-ended load		-66		dBm
Spurious emissions, 1GHz to 12.75GHz	Measurement in a 50 $\Omega$ single-ended load		-53		dBm
Frequency error tolerance	Difference between the incoming carrier frequency and the internally generated carrier frequency		> 100		ppm
Symbol rate error tolerance	Difference between incoming symbol rate and the internally generated symbol rate		> 800		ppm
RSSI dynamic range			95		dB
RSSI accuracy			$\pm 4$		dB

## 7.17 Zigbee and Thread - IEEE 802.15.4-2006 2.4GHz (OQPSK DSSS1:8, 250kbps) - TX

When measured on the LP-EM-CC1354P10-1 reference design with  $T_c = 25^\circ\text{C}$ ,  $V_{\text{DDS}} = 3.0\text{V}$ ,  $f_{\text{RF}} = 2440\text{MHz}$  with DC/DC enabled unless otherwise noted. All measurements are performed at the antenna input with a combined RX and TX path. All measurements are performed conducted.

PARAMETER	TEST CONDITIONS	MIN	TYP	MAX	UNIT
<b>General Parameters</b>					
Max output power, 2.4GHz PA	Differential mode, delivered to a single-ended 50 $\Omega$ load through a balun		5		dBm
Output power programmable range, 2.4GHz PA	Differential mode, delivered to a single-ended 50 $\Omega$ load through a balun		26		dB
<b>Spurious emissions and harmonics</b>					
Spurious emissions, 2.4GHz PA	f < 1GHz, outside restricted bands	+5dBm setting	< -36		dBm
	f < 1GHz, restricted bands ETSI		< -47		dBm
	f < 1GHz, restricted bands FCC		< -55		dBm
	f > 1GHz, including harmonics		< -42		dBm
Harmonics, 2.4GHz PA	Second harmonic		< -42		dBm
	Third harmonic		< -42		dBm
<b>IEEE 802.15.4-2006 2.4GHz (OQPSK DSSS1:8, 250kbps)</b>					
Error vector magnitude, 2.4-GHz PA	+5dBm setting		2		%

## 7.18 Timing and Switching Characteristics

### 7.18.1 Reset Timing

PARAMETER	MIN	TYP	MAX	UNIT
RESET_N low duration	1			$\mu\text{s}$

### 7.18.2 Wakeup Timing

Measured over operating free-air temperature with  $V_{\text{DDS}} = 3.0\text{V}$  (unless otherwise noted). The times listed here do not include software overhead.

PARAMETER	TEST CONDITIONS	MIN	TYP	MAX	UNIT
MCU, Reset to Active <sup>(1)</sup>		850 - 4000			$\mu\text{s}$
MCU, Shutdown to Active <sup>(1)</sup>		850 - 4000			$\mu\text{s}$
MCU, Standby to Active			160		$\mu\text{s}$
MCU, Active to Standby			39		$\mu\text{s}$
MCU, Idle to Active			15		$\mu\text{s}$

- (1) The wakeup time is dependent on remaining charge on VDDR capacitor when starting the device, and thus how long the device has been in Reset or Shutdown before starting up again. The wake up time increases with a higher capacitor value.

### 7.18.3 Clock Specifications

#### 7.18.3.1 48MHz Clock Input (TCXO)

Measured on a Texas Instruments reference design with  $T_c = 25^\circ\text{C}$ ,  $V_{\text{DD5}} = 3.0\text{V}$ , unless otherwise noted.<sup>(1)</sup>

PARAMETER	TEST CONDITIONS	MIN	TYP	MAX	UNIT
Clock frequency			48		MHz
TCXO clipped sine output, peak-to-peak	TCXO clipped sine output connected to pin X48M_P through series capacitor	0.8		1.7	V
TCXO with CMOS output, High input voltage	TCXO with CMOS output directly coupled to pin X48M_P	1.3		VDDR	V
TCXO with CMOS output, Low input voltage		0		0.3	V

(1) Probing or otherwise stopping the TCXO while the DC/DC converter is enabled may cause permanent damage to the device.

#### 7.18.3.2 48MHz Crystal Oscillator (XOSC\_HF)

Measured on a Texas Instruments reference design with  $T_c = 25^\circ\text{C}$ ,  $V_{\text{DD5}} = 3.0\text{V}$ , unless otherwise noted.<sup>(1)</sup>

	PARAMETER	MIN	TYP	MAX	UNIT
F	Crystal frequency		48		MHz
ESR	Equivalent series resistance $6\text{ pF} < C_L \leq 9\text{ pF}$		20	60	$\Omega$
ESR	Equivalent series resistance $5\text{ pF} < C_L \leq 6\text{ pF}$			80	$\Omega$
$L_M$	Motional inductance, relates to the load capacitance that is used for the crystal ( $C_L$ in Farads) <sup>(2)</sup>		$< 3 \times 10^{-25} / C_L^2$		H
$C_L$	Crystal load capacitance <sup>(3)</sup>	5	7 <sup>(4)</sup>	9	pF
t	Start-up time <sup>(5)</sup>		200		$\mu\text{s}$

- (1) Probing or otherwise stopping the crystal while the DC/DC converter is enabled may cause permanent damage to the device.
- (2) The crystal manufacturer's specification must satisfy this requirement for proper operation.
- (3) Adjustable load capacitance is integrated into the device. External load capacitors are required for systems targeting compliance with certain regulations. See the device errata for further details.
- (4) On-chip default connected capacitance including reference design parasitic capacitance. Connected internal capacitance is changed through software in the Customer Configuration section (CCFG).
- (5) Start-up time using the TI-provided power driver. Start-up time may increase if driver is not used.

#### 7.18.3.3 48MHz RC Oscillator (RCOSC\_HF)

Measured on a Texas Instruments reference design with  $T_c = 25^\circ\text{C}$ ,  $V_{\text{DD5}} = 3.0\text{V}$ , unless otherwise noted.

	MIN	TYP	MAX	UNIT
Frequency		48		MHz
Uncalibrated frequency accuracy		$\pm 1$		%
Calibrated frequency accuracy <sup>(1)</sup>		$\pm 0.25$		%
Start-up time		5		$\mu\text{s}$

(1) Accuracy relative to the calibration source (XOSC\_HF).

#### 7.18.3.4 2MHz RC Oscillator (RCOSC\_MF)

Measured on a Texas Instruments reference design with  $T_c = 25^\circ\text{C}$ ,  $V_{\text{DD5}} = 3.0\text{V}$ , unless otherwise noted.

	MIN	TYP	MAX	UNIT
Calibrated frequency		2		MHz
Start-up time		5		$\mu\text{s}$

#### 7.18.3.5 32.768 kHz Crystal Oscillator (XOSC\_LF)

Measured on a Texas Instruments reference design with  $T_c = 25^\circ\text{C}$ ,  $V_{\text{DD5}} = 3.0\text{V}$ , unless otherwise noted.

	MIN	TYP	MAX	UNIT
Crystal frequency		32.768		kHz

### 7.18.3.5 32.768 kHz Crystal Oscillator (XOSC\_LF) (continued)

Measured on a Texas Instruments reference design with  $T_c = 25^\circ\text{C}$ ,  $V_{\text{DDS}} = 3.0\text{V}$ , unless otherwise noted.

		MIN	TYP	MAX	UNIT
ESR	Equivalent series resistance		30	100	k $\Omega$
$C_L$	Crystal load capacitance	6	7 <sup>(1)</sup>	12	pF

- (1) Default load capacitance using TI reference designs including parasitic capacitance. Crystals with different load capacitance may be used.

### 7.18.3.6 32 kHz RC Oscillator (RCOSC\_LF)

Measured on a Texas Instruments reference design with  $T_c = 25^\circ\text{C}$ ,  $V_{\text{DDS}} = 3.0\text{V}$ , unless otherwise noted.

		MIN	TYP	MAX	UNIT
	Calibrated frequency		32.8 <sup>(1)</sup>		kHz
	Temperature coefficient		50		ppm/ $^\circ\text{C}$

- (1) When using RCOSC\_LF as source for the low frequency system clock (SCLK\_LF), the accuracy of the SCLK\_LF-derived Real Time Clock (RTC) can be improved by measuring RCOSC\_LF relative to XOSC\_HF and compensating for the RTC tick speed. This functionality is available through the TI-provided Power driver.

## 7.18.4 Serial Peripheral Interface (SPI) Characteristics

### 7.18.4.1 SPI Characteristics

over operating free-air temperature range (unless otherwise noted).

PARAMETERS		TEST CONDITIONS	MIN	TYP	MAX	UNIT
$f_{\text{SCLK}}$ $1/t_{\text{sclk}}$	SPI clock frequency	Master Mode $1.8 < V_{\text{DDS}} < 3.8$			12	MHz
		Slave Mode $2.7 < V_{\text{DDS}} < 3.8$			8	
		Slave Mode $V_{\text{DDS}} < 2.7$			7	
$\text{DC}_{\text{SCK}}$	SCK Duty Cycle		45	50	55	%

### 7.18.4.2 SPI Master Mode

over operating free-air temperature range (unless otherwise noted).

PARAMETERS		TEST CONDITIONS	MIN	TYP	MAX	UNIT
$t_{\text{SCLK\_H/L}}$	SCLK High or Low time		$(t_{\text{SPI}}/2) - 1$	$t_{\text{SPI}} / 2$	$(t_{\text{SPI}}/2) + 1$	ns
$t_{\text{CS.LEAD}}$	CS lead-time, CS active to clock		1			SCLK
$t_{\text{CS.LAG}}$	CS lag time, Last clock to CS inactive		1			SCLK
$t_{\text{CS.ACC}}$	CS access time, CS active to MOSI data out				1	SCLK
$t_{\text{CS.DIS}}$	CS disable time, CS inactive to MOSI high impedance				1	SCLK
$t_{\text{SU.MI}}$	MISO input data setup time <sup>(1)</sup>	$V_{\text{DDS}} = 3.3\text{V}$	12.5			ns
$t_{\text{SU.MI}}$	MISO input data setup time	$V_{\text{DDS}} = 1.8\text{V}$	23.5			ns
$t_{\text{HD.MI}}$	MISO input data hold time		0			ns
$t_{\text{VALID.MO}}$	MOSI output data valid time <sup>(2)</sup>	SCLK edge to MOSI valid, $\text{CL} = 20\text{ pF}$ (4)			13	ns
$t_{\text{HD.MO}}$	MOSI output data hold time <sup>(3)</sup>	$\text{CL} = 20\text{ pF}$	0			ns

- (1) The MISO input data setup time can be fully compensated when delayed sampling feature is enabled.  
 (2) Specifies the time to drive the next valid data to the output after the output changing SCLK clock edge.

(3) Specifies how long data on the output is valid after the output changing SCLK clock edge.

### 7.18.4.3 SPI Master Mode Timing Diagrams

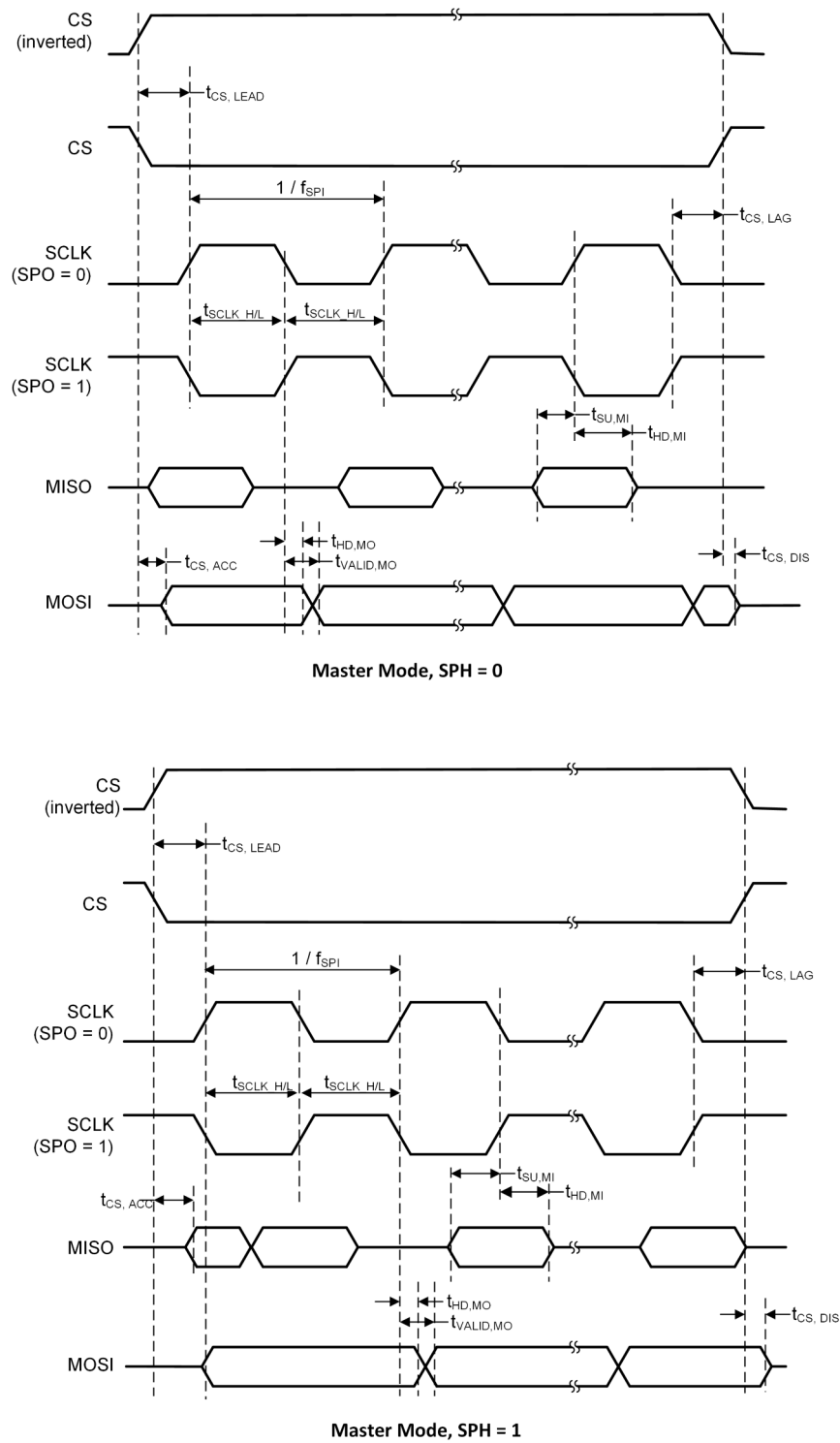

**Figure 7-1. SPI Master Mode Timing**

#### 7.18.4.4 SPI Slave Mode

over operating free-air temperature range (unless otherwise noted).

PARAMETERS		TEST CONDITIONS	MIN	TYP	MAX	UNIT
$t_{CS.LEAD}$	CS lead-time, CS active to clock		1			SCLK
$t_{CS.LAG}$	CS lag time, Last clock to CS inactive		1			SCLK
$t_{CS.ACC}$	CS access time, CS active to MISO data out	VDDS = 3.3V			56	ns
$t_{CS.ACC}$	CS access time, CS active to MISO data out	VDDS = 1.8V			70	ns
$t_{CS.DIS}$	CS disable time, CS inactive to MISO high impedance	VDDS = 3.3V			56	ns
$t_{CS.DIS}$	CS disable time, CS inactive to MISO high impedance	VDDS = 1.8V			70	ns
$t_{SU.SI}$	MOSI input data setup time		30			ns
$t_{HD.SI}$	MOSI input data hold time		0			ns
$t_{VALID.SO}$	MISO output data valid time <sup>(1)</sup>	SCLK edge to MISO valid, $C_L = 20$ pF, 3.3V (4)			50	ns
$t_{VALID.SO}$	MISO output data valid time <sup>(1)</sup>	SCLK edge to MISO valid, $C_L = 20$ pF, 1.8V (4)			65	ns
$t_{HD.SO}$	MISO output data hold time <sup>(2)</sup>	$C_L = 20$ pF	0			ns

(1) Specifies the time to drive the next valid data to the output after the output changing SCLK clock edge.

(2) Specifies how long data on the output is valid after the output changing SCLK clock edge.

### 7.18.4.5 SPI Slave Mode Timing Diagrams

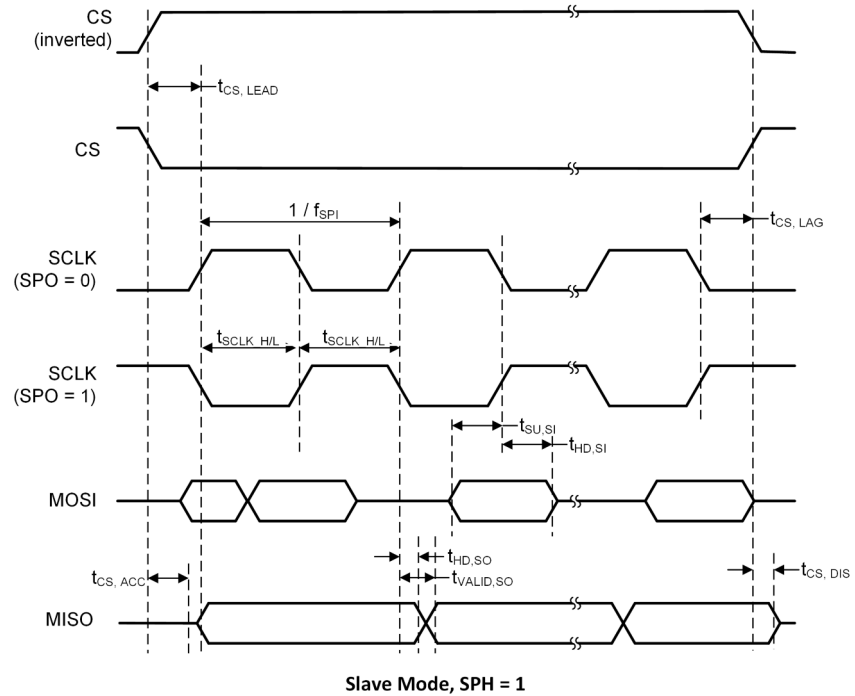
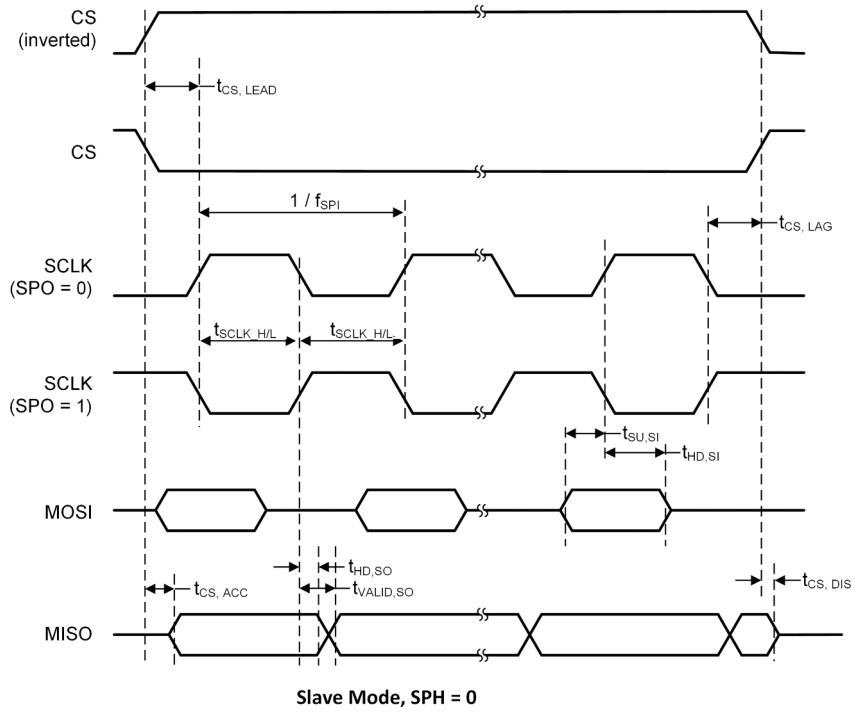

**Figure 7-2. SPI Slave Mode Timing**

## 7.18.5 UART

### 7.18.5.1 UART Characteristics

over operating free-air temperature range (unless otherwise noted).

PARAMETER	MIN	TYP	MAX	UNIT
UART rate			3	MBaud

## 7.19 Peripheral Characteristics

### 7.19.1 ADC

#### 7.19.1.1 Analog-to-Digital Converter (ADC) Characteristics

$T_c = 25^\circ\text{C}$ ,  $V_{\text{DD5}} = 3.0\text{V}$  and voltage scaling enabled, unless otherwise noted.<sup>(1)</sup>

Performance numbers require use of offset and gain adjustments in software by TI-provided ADC drivers.

PARAMETER	TEST CONDITIONS	MIN	TYP	MAX	UNIT
Input voltage range		0		V <sub>DD5</sub>	V
Resolution			12		Bits
Sample Rate				200	ksps
Offset	Internal 4.3V equivalent reference <sup>(2)</sup>		-0.24		LSB
Gain error	Internal 4.3V equivalent reference <sup>(2)</sup>		7.14		LSB
DNL <sup>(3)</sup>	Differential nonlinearity		>-1		LSB
INL	Integral nonlinearity		±4		LSB
ENOB	Effective number of bits	Internal 4.3V equivalent reference <sup>(2)</sup> , 200 kSamples/s, 9.6kHz input tone	9.8		Bits
		Internal 4.3V equivalent reference <sup>(2)</sup> , 200 kSamples/s, 9.6kHz input tone, DC/DC enabled	9.8		
		V <sub>DD5</sub> as reference, 200 kSamples/s, 9.6kHz input tone	10.1		
		Internal reference, voltage scaling disabled, 32 samples average, 200 kSamples/s, 300Hz input tone	11.1		
		Internal reference, voltage scaling disabled, 14-bit mode, 200 kSamples/s, 300Hz input tone <sup>(4)</sup>	11.3		
		Internal reference, voltage scaling disabled, 15-bit mode, 200 kSamples/s, 300Hz input tone <sup>(4)</sup>	11.6		
THD	Total harmonic distortion	Internal 4.3V equivalent reference <sup>(2)</sup> , 200 kSamples/s, 9.6kHz input tone	-65		dB
		V <sub>DD5</sub> as reference, 200 kSamples/s, 9.6kHz input tone	-70		
		Internal reference, voltage scaling disabled, 32 samples average, 200 kSamples/s, 300Hz input tone	-72		
SINAD, SNDR	Signal-to-noise and distortion ratio	Internal 4.3V equivalent reference <sup>(2)</sup> , 200 kSamples/s, 9.6kHz input tone	60		dB
		V <sub>DD5</sub> as reference, 200 kSamples/s, 9.6kHz input tone	63		
		Internal reference, voltage scaling disabled, 32 samples average, 200 kSamples/s, 300Hz input tone	68		
SFDR	Spurious-free dynamic range	Internal 4.3V equivalent reference <sup>(2)</sup> , 200 kSamples/s, 9.6kHz input tone	70		dB
		V <sub>DD5</sub> as reference, 200 kSamples/s, 9.6kHz input tone	73		
		Internal reference, voltage scaling disabled, 32 samples average, 200 kSamples/s, 300Hz input tone	75		
	Conversion time	Serial conversion, time-to-output, 24MHz clock	50		Clock Cycles
	Current consumption	Internal 4.3V equivalent reference <sup>(2)</sup>	0.42		mA
	Current consumption	V <sub>DD5</sub> as reference	0.6		mA
	Reference voltage	Equivalent fixed internal reference (input voltage scaling enabled). For best accuracy, the ADC conversion should be initiated through the TI-RTOS API in order to include the gain/offset compensation factors stored in FCFG1	4.3 <sup>(2)</sup> <sup>(5)</sup>		V

### 7.19.1.1 Analog-to-Digital Converter (ADC) Characteristics (continued)

$T_c = 25^\circ\text{C}$ ,  $V_{\text{DD5}} = 3.0\text{V}$  and voltage scaling enabled, unless otherwise noted.<sup>(1)</sup>

Performance numbers require use of offset and gain adjustments in software by TI-provided ADC drivers.

PARAMETER		TEST CONDITIONS	MIN	TYP	MAX	UNIT
	Reference voltage	Fixed internal reference (input voltage scaling disabled). For best accuracy, the ADC conversion should be initiated through the TI-RTOS API in order to include the gain/offset compensation factors stored in FCFG1. This value is derived from the scaled value (4.3V) as follows: $V_{\text{ref}} = 4.3\text{V} \times 1408 / 4095$		1.48		V
	Reference voltage	VDD5 as reference, input voltage scaling enabled		VDD5		V
	Reference voltage	VDD5 as reference, input voltage scaling disabled		VDD5 / 2.82 <sup>(5)</sup>		V
	Input impedance	200 kSamples/s, voltage scaling enabled. Capacitive input, Input impedance depends on sampling frequency and sampling time		>1		MΩ

- (1) Using IEEE Std 1241-2010 for terminology and test methods.
- (2) Input signal scaled down internally before conversion, as if voltage range was 0V to 4.3V.
- (3) No missing codes.
- (4)  $\text{ADC\_output} = \Sigma(4^n \text{ samples}) \gg n$ ,  $n$  = desired extra bits.
- (5) Applied voltage must be within [Absolute Maximum Ratings](#) at all times.

## 7.19.2 DAC

### 7.19.2.1 Digital-to-Analog Converter (DAC) Characteristics

$T_c = 25^\circ\text{C}$ ,  $V_{\text{DDS}} = 3.0\text{V}$ , unless otherwise noted.

PARAMETER		TEST CONDITIONS	MIN	TYP	MAX	UNIT
<b>General Parameters</b>						
	Resolution			8		Bits
$V_{\text{DDS}}$	Supply voltage	Any load, any $V_{\text{REF}}$ , pre-charge OFF, DAC charge-pump ON	1.8		3.8	V
		External Load <sup>(1)</sup> , any $V_{\text{REF}}$ , pre-charge OFF, DAC charge-pump OFF	2.0		3.8	
		Any load, $V_{\text{REF}} = \text{DCOUP}$ , pre-charge ON	2.6		3.8	
$F_{\text{DAC}}$	Clock frequency	Buffer ON (recommended for external load)	16		250	kHz
		Buffer OFF (internal load)	16		1000	
	Voltage output settling time	$V_{\text{REF}} = V_{\text{DDS}}$ , buffer OFF, internal load		13		1 / $F_{\text{DAC}}$
		$V_{\text{REF}} = V_{\text{DDS}}$ , buffer ON, external capacitive load = 20pF <sup>(2)</sup>		13.8		
	External capacitive load			20	200	pF
	External resistive load		10			MΩ
	Short circuit current				400	μA
$Z_{\text{MAX}}$	Max output impedance $V_{\text{ref}} = V_{\text{DDS}}$ , buffer ON, CLK 250kHz	$V_{\text{DDS}} = 3.8\text{V}$ , DAC charge-pump OFF		50.8		kΩ
		$V_{\text{DDS}} = 3.0\text{V}$ , DAC charge-pump ON		51.7		
		$V_{\text{DDS}} = 3.0\text{V}$ , DAC charge-pump OFF		53.2		
		$V_{\text{DDS}} = 2.0\text{V}$ , DAC charge-pump ON		48.7		
		$V_{\text{DDS}} = 2.0\text{V}$ , DAC charge-pump OFF		70.2		
		$V_{\text{DDS}} = 1.8\text{V}$ , DAC charge-pump ON		46.3		
		$V_{\text{DDS}} = 1.8\text{V}$ , DAC charge-pump OFF		88.9		
<b>Internal Load - Continuous Time Comparator / Low Power Clocked Comparator</b>						
DNL	Differential nonlinearity	$V_{\text{REF}} = V_{\text{DDS}}$ , load = Continuous Time Comparator or Low Power Clocked Comparator $F_{\text{DAC}} = 250\text{kHz}$		±1		LSB <sup>(3)</sup>
	Differential nonlinearity	$V_{\text{REF}} = V_{\text{DDS}}$ , load = Continuous Time Comparator or Low Power Clocked Comparator $F_{\text{DAC}} = 16\text{kHz}$		±1.2		
	Offset error <sup>(4)</sup> Load = Continuous Time Comparator	$V_{\text{REF}} = V_{\text{DDS}} = 3.8\text{V}$		±0.64		LSB <sup>(3)</sup>
		$V_{\text{REF}} = V_{\text{DDS}} = 3.0\text{V}$		±0.81		
		$V_{\text{REF}} = V_{\text{DDS}} = 1.8\text{V}$		±1.27		
		$V_{\text{REF}} = \text{DCOUP}$ , pre-charge ON		±3.43		
		$V_{\text{REF}} = \text{DCOUP}$ , pre-charge OFF		±2.88		
		$V_{\text{REF}} = \text{ADCREf}$		±2.37		
	Offset error <sup>(4)</sup> Load = Low Power Clocked Comparator	$V_{\text{REF}} = V_{\text{DDS}} = 3.8\text{V}$		±0.78		LSB <sup>(3)</sup>
		$V_{\text{REF}} = V_{\text{DDS}} = 3.0\text{V}$		±0.77		
		$V_{\text{REF}} = V_{\text{DDS}} = 1.8\text{V}$		±3.46		
		$V_{\text{REF}} = \text{DCOUP}$ , pre-charge ON		±3.44		
		$V_{\text{REF}} = \text{DCOUP}$ , pre-charge OFF		±4.70		
		$V_{\text{REF}} = \text{ADCREf}$		±4.11		
	Max code output voltage variation <sup>(4)</sup> Load = Continuous Time Comparator	$V_{\text{REF}} = V_{\text{DDS}} = 3.8\text{V}$		±1.53		LSB <sup>(3)</sup>
		$V_{\text{REF}} = V_{\text{DDS}} = 3.0\text{V}$		±1.71		
		$V_{\text{REF}} = V_{\text{DDS}} = 1.8\text{V}$		±2.10		
		$V_{\text{REF}} = \text{DCOUP}$ , pre-charge ON		±6.00		
		$V_{\text{REF}} = \text{DCOUP}$ , pre-charge OFF		±3.85		
		$V_{\text{REF}} = \text{ADCREf}$		±5.84		

### 7.19.2.1 Digital-to-Analog Converter (DAC) Characteristics (continued)

T<sub>c</sub> = 25°C, V<sub>DD</sub>S = 3.0V, unless otherwise noted.

PARAMETER		TEST CONDITIONS	MIN	TYP	MAX	UNIT
Max code output voltage variation <sup>(4)</sup> Load = Low Power Clocked Comparator	V <sub>REF</sub> = V <sub>DD</sub> S = 3.8V			±2.92		LSB <sup>(3)</sup>
	V <sub>REF</sub> = V <sub>DD</sub> S = 3.0V			±3.06		
	V <sub>REF</sub> = V <sub>DD</sub> S = 1.8V			±3.91		
	V <sub>REF</sub> = DCOUPL, pre-charge ON			±7.84		
	V <sub>REF</sub> = DCOUPL, pre-charge OFF			±4.06		
	V <sub>REF</sub> = ADCREF			±6.94		
Output voltage range <sup>(4)</sup> Load = Continuous Time Comparator	V <sub>REF</sub> = V <sub>DD</sub> S = 3.8V, code 1			0.03		V
	V <sub>REF</sub> = V <sub>DD</sub> S = 3.8V, code 255			3.62		
	V <sub>REF</sub> = V <sub>DD</sub> S = 3.0V, code 1			0.02		
	V <sub>REF</sub> = V <sub>DD</sub> S = 3.0V, code 255			2.86		
	V <sub>REF</sub> = V <sub>DD</sub> S = 1.8V, code 1			0.01		
	V <sub>REF</sub> = V <sub>DD</sub> S = 1.8V, code 255			1.71		
	V <sub>REF</sub> = DCOUPL, pre-charge OFF, code 1			0.01		
	V <sub>REF</sub> = DCOUPL, pre-charge OFF, code 255			1.21		
	V <sub>REF</sub> = DCOUPL, pre-charge ON, code 1			1.27		
	V <sub>REF</sub> = DCOUPL, pre-charge ON, code 255			2.46		
	V <sub>REF</sub> = ADCREF, code 1			0.01		
	V <sub>REF</sub> = ADCREF, code 255			1.41		
Output voltage range <sup>(4)</sup> Load = Low Power Clocked Comparator	V <sub>REF</sub> = V <sub>DD</sub> S = 3.8V, code 1			0.03		V
	V <sub>REF</sub> = V <sub>DD</sub> S = 3.8V, code 255			3.61		
	V <sub>REF</sub> = V <sub>DD</sub> S = 3.0V, code 1			0.02		
	V <sub>REF</sub> = V <sub>DD</sub> S = 3.0V, code 255			2.85		
	V <sub>REF</sub> = V <sub>DD</sub> S = 1.8V, code 1			0.01		
	V <sub>REF</sub> = V <sub>DD</sub> S = 1.8V, code 255			1.71		
	V <sub>REF</sub> = DCOUPL, pre-charge OFF, code 1			0.01		
	V <sub>REF</sub> = DCOUPL, pre-charge OFF, code 255			1.21		
	V <sub>REF</sub> = DCOUPL, pre-charge ON, code 1			1.27		
	V <sub>REF</sub> = DCOUPL, pre-charge ON, code 255			2.46		
	V <sub>REF</sub> = ADCREF, code 1			0.01		
	V <sub>REF</sub> = ADCREF, code 255			1.41		
<b>External Load (Keysight 34401A Multimeter)</b>						
INL	Integral nonlinearity	V <sub>REF</sub> = V <sub>DD</sub> S, F <sub>DAC</sub> = 250kHz		±1		LSB <sup>(3)</sup>
		V <sub>REF</sub> = DCOUPL, F <sub>DAC</sub> = 250kHz		±1		
		V <sub>REF</sub> = ADCREF, F <sub>DAC</sub> = 250kHz		±1		
DNL	Differential nonlinearity	V <sub>REF</sub> = V <sub>DD</sub> S, F <sub>DAC</sub> = 250kHz		±1		LSB <sup>(3)</sup>
Offset error		V <sub>REF</sub> = V <sub>DD</sub> S = 3.8V		±0.20		LSB <sup>(3)</sup>
		V <sub>REF</sub> = V <sub>DD</sub> S = 3.0V		±0.25		
		V <sub>REF</sub> = V <sub>DD</sub> S = 1.8V		±0.45		
		V <sub>REF</sub> = DCOUPL, pre-charge ON		±1.55		
		V <sub>REF</sub> = DCOUPL, pre-charge OFF		±1.30		
		V <sub>REF</sub> = ADCREF		±1.10		
Max code output voltage variation		V <sub>REF</sub> = V <sub>DD</sub> S = 3.8V		±0.60		LSB <sup>(3)</sup>
		V <sub>REF</sub> = V <sub>DD</sub> S = 3.0V		±0.55		
		V <sub>REF</sub> = V <sub>DD</sub> S = 1.8V		±0.60		
		V <sub>REF</sub> = DCOUPL, pre-charge ON		±3.45		
		V <sub>REF</sub> = DCOUPL, pre-charge OFF		±2.10		
		V <sub>REF</sub> = ADCREF		±1.90		

### 7.19.2.1 Digital-to-Analog Converter (DAC) Characteristics (continued)

$T_c = 25^\circ\text{C}$ ,  $V_{DD5} = 3.0\text{V}$ , unless otherwise noted.

PARAMETER	TEST CONDITIONS	MIN	TYP	MAX	UNIT
Output voltage range Load = Low Power Clocked Comparator	$V_{REF} = V_{DD5} = 3.8\text{V}$ , code 1		0.03		V
	$V_{REF} = V_{DD5} = 3.8\text{V}$ , code 255		3.61		
	$V_{REF} = V_{DD5} = 3.0\text{V}$ , code 1		0.02		
	$V_{REF} = V_{DD5} = 3.0\text{V}$ , code 255		2.85		
	$V_{REF} = V_{DD5} = 1.8\text{V}$ , code 1		0.02		
	$V_{REF} = V_{DD5} = 1.8\text{V}$ , code 255		1.71		
	$V_{REF} = \text{DCOUPPL}$ , pre-charge OFF, code 1		0.02		
	$V_{REF} = \text{DCOUPPL}$ , pre-charge OFF, code 255		1.20		
	$V_{REF} = \text{DCOUPPL}$ , pre-charge ON, code 1		1.27		
	$V_{REF} = \text{DCOUPPL}$ , pre-charge ON, code 255		2.46		
	$V_{REF} = \text{ADCREFL}$ , code 1		0.02		
	$V_{REF} = \text{ADCREFL}$ , code 255		1.42		

- (1) Keysight 34401A Multimeter.
- (2) A load > 20pF increincreasesettling time.
- (3) 1 LSB ( $V_{REF} 3.8\text{V}/3.0\text{V}/1.8\text{V}/\text{DCOUPPL}/\text{ADCREFL}$ ) = 14.10mV/11.13mV/6.68mV/4.67mV/5.48mV.
- (4) Includes comparator offset.

### 7.19.3 Temperature and Battery Monitor

#### 7.19.3.1 Temperature Sensor

Measured on a Texas Instruments reference design with  $T_c = 25^\circ\text{C}$ ,  $V_{\text{DDS}} = 3.0\text{V}$ , unless otherwise noted.

PARAMETER	TEST CONDITIONS	MIN	TYP	MAX	UNIT
Resolution			2		$^\circ\text{C}$
Accuracy	$-40^\circ\text{C}$ to $0^\circ\text{C}$		$\pm 5.0$		$^\circ\text{C}$
Accuracy	$0^\circ\text{C}$ to $105^\circ\text{C}$		$\pm 3.5$		$^\circ\text{C}$
Supply voltage coefficient <sup>(1)</sup>			3.6		$^\circ\text{C}/\text{V}$

(1) The temperature sensor is automatically compensated for VDDS variation when using the TI-provided driver.

#### 7.19.3.2 Battery Monitor

Measured on a Texas Instruments reference design with  $T_c = 25^\circ\text{C}$ , unless otherwise noted.

PARAMETER	TEST CONDITIONS	MIN	TYP	MAX	UNIT
Resolution			25		mV
Range		1.8		3.8	V
Integral nonlinearity (max)			23		mV
Accuracy	$V_{\text{DDS}} = 3.0\text{V}$		22.5		mV
Offset error			-32		mV
Gain error			-1		%

## 7.19.4 Comparators

### 7.19.4.1 Low-Power Clocked Comparator

$T_c = 25^\circ\text{C}$ ,  $V_{DD5} = 3.0\text{V}$ , unless otherwise noted.

PARAMETER	TEST CONDITIONS	MIN	TYP	MAX	UNIT
Input voltage range		0		$V_{DD5}$	V
Clock frequency			SCLK_LF		
Internal reference voltage <sup>(1)</sup>	Using internal DAC with $V_{DD5}$ as reference voltage, DAC code = 0 - 255		0.024 - 2.865		V
Offset	Measured at $V_{DD5} / 2$ , includes error from internal DAC		$\pm 5$		mV
Decision time	Step from $-50\text{ mV}$ to $50\text{ mV}$		1		Clock Cycle

- (1) The comparator can use an internal 8 bits DAC as its reference. The DAC output voltage range depends on the reference voltage selected. See [DAC Characteristics](#).

### 7.19.4.2 Continuous Time Comparator

$T_c = 25^\circ\text{C}$ ,  $V_{DD5} = 3.0\text{V}$ , unless otherwise noted.

PARAMETER	TEST CONDITIONS	MIN	TYP	MAX	UNIT
Input voltage range <sup>(1)</sup>		0		$V_{DD5}$	V
Offset	Measured at $V_{DD5} / 2$		$\pm 5$		mV
Decision time	Step from $-10\text{mV}$ to $10\text{mV}$		0.78		$\mu\text{s}$
Current consumption	Internal reference		8.6		$\mu\text{A}$

- (1) The input voltages can be generated externally and connected throughout I/Os or an internal reference voltage can be generated using the DAC.

## 7.19.5 Current Source

### 7.19.5.1 Programmable Current Source

$T_c = 25^\circ\text{C}$ ,  $V_{DD5} = 3.0\text{V}$ , unless otherwise noted.

PARAMETER	TEST CONDITIONS	MIN	TYP	MAX	UNIT
Current source programmable output range (logarithmic range)			0.25 - 20		$\mu\text{A}$
Resolution			0.25		$\mu\text{A}$

## 7.19.6 GPIO

### 7.19.6.1 GPIO DC Characteristics

PARAMETER	TEST CONDITIONS	MIN	TYP	MAX	UNIT
<b>T<sub>A</sub> = 25°C, V<sub>DD5</sub> = 1.8V</b>					
GPIO VOH at 8mA load	IOCURR = 2, high-drive GPIOs only		1.56		V
GPIO VOL at 8mA load	IOCURR = 2, high-drive GPIOs only		0.24		V
GPIO VOH at 4mA load	IOCURR = 1		1.59		V
GPIO VOL at 4mA load	IOCURR = 1		0.21		V
GPIO pullup current	Input mode, pullup enabled, Vpad = 0 V		73		μA
GPIO pulldown current	Input mode, pulldown enabled, Vpad = VDD5		19		μA
GPIO low-to-high input transition, with hysteresis	IH = 1, transition voltage for input read as 0 → 1		1.08		V
GPIO high-to-low input transition, with hysteresis	IH = 1, transition voltage for input read as 1 → 0		0.73		V
GPIO input hysteresis	IH = 1, difference between 0 → 1 and 1 → 0 points		0.35		V
<b>T<sub>A</sub> = 25°C, V<sub>DD5</sub> = 3.0V</b>					
GPIO VOH at 8mA load	IOCURR = 2, high-drive GPIOs only		2.59		V
GPIO VOL at 8mA load	IOCURR = 2, high-drive GPIOs only		0.42		V
GPIO VOH at 4mA load	IOCURR = 1		2.63		V
GPIO VOL at 4mA load	IOCURR = 1		0.40		V
<b>T<sub>A</sub> = 25°C, V<sub>DD5</sub> = 3.8V</b>					
GPIO pullup current	Input mode, pullup enabled, Vpad = 0 V		282		μA
GPIO pulldown current	Input mode, pulldown enabled, Vpad = VDD5		110		μA
GPIO low-to-high input transition, with hysteresis	IH = 1, transition voltage for input read as 0 → 1		1.97		V
GPIO high-to-low input transition, with hysteresis	IH = 1, transition voltage for input read as 1 → 0		1.55		V
GPIO input hysteresis	IH = 1, difference between 0 → 1 and 1 → 0 points		0.42		V
<b>T<sub>A</sub> = 25°C</b>					
VIH	Lowest GPIO input voltage reliably interpreted as a <i>High</i>	0.8*V <sub>DD5</sub>			V
VIL	Highest GPIO input voltage reliably interpreted as a <i>Low</i>		0.2*V <sub>DD5</sub>		V

## 7.20 Typical Characteristics

All measurements in this section are done with  $T_c = 25^\circ\text{C}$  and  $V_{\text{DD5}} = 3.0\text{V}$ , unless otherwise noted. See *Recommended Operating Conditions*, [Section 7.3](#), for device limits. Values exceeding these limits are for reference only.

### 7.20.1 MCU Current

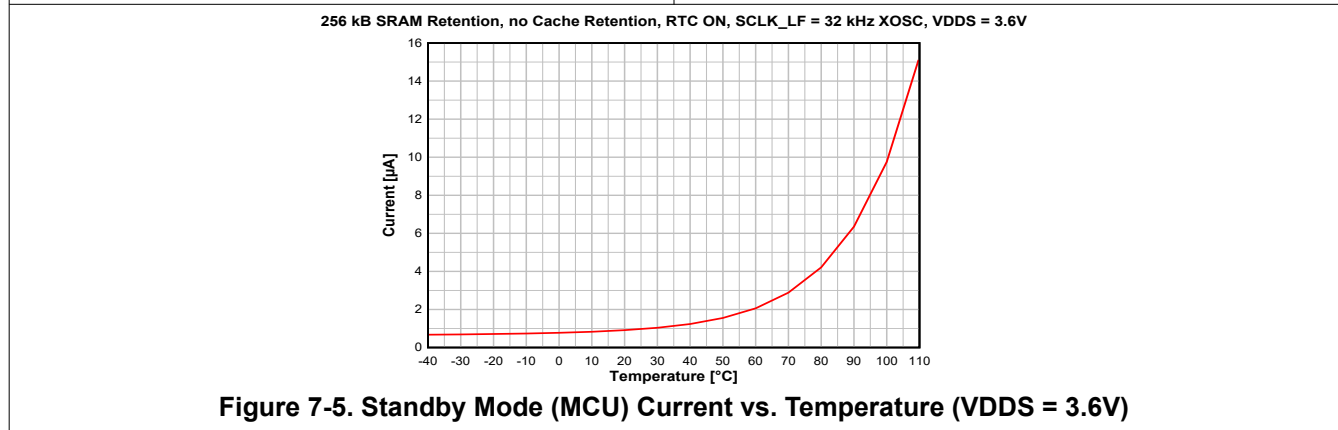
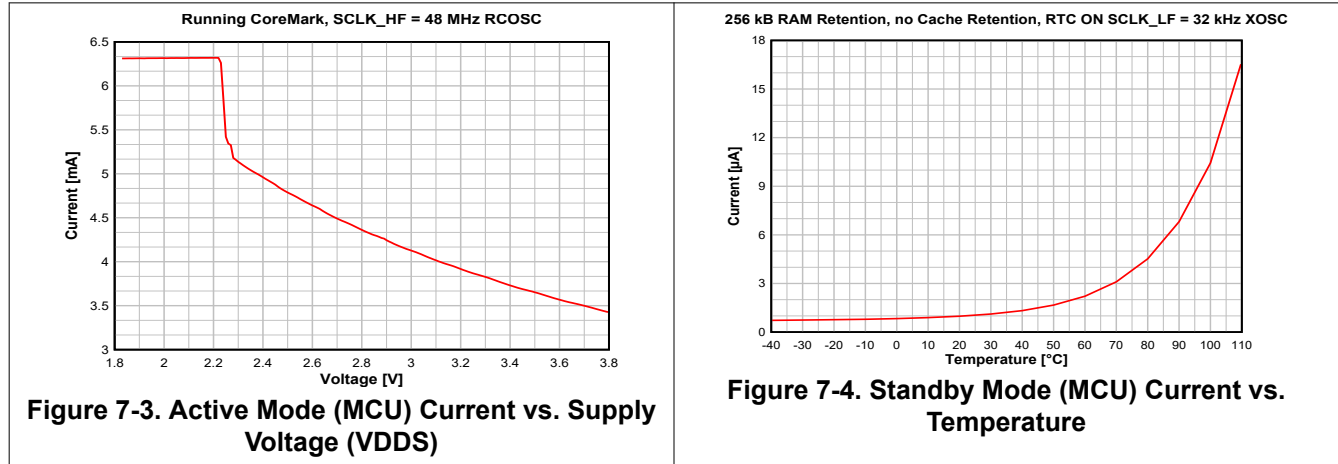

### 7.20.2 RX Current

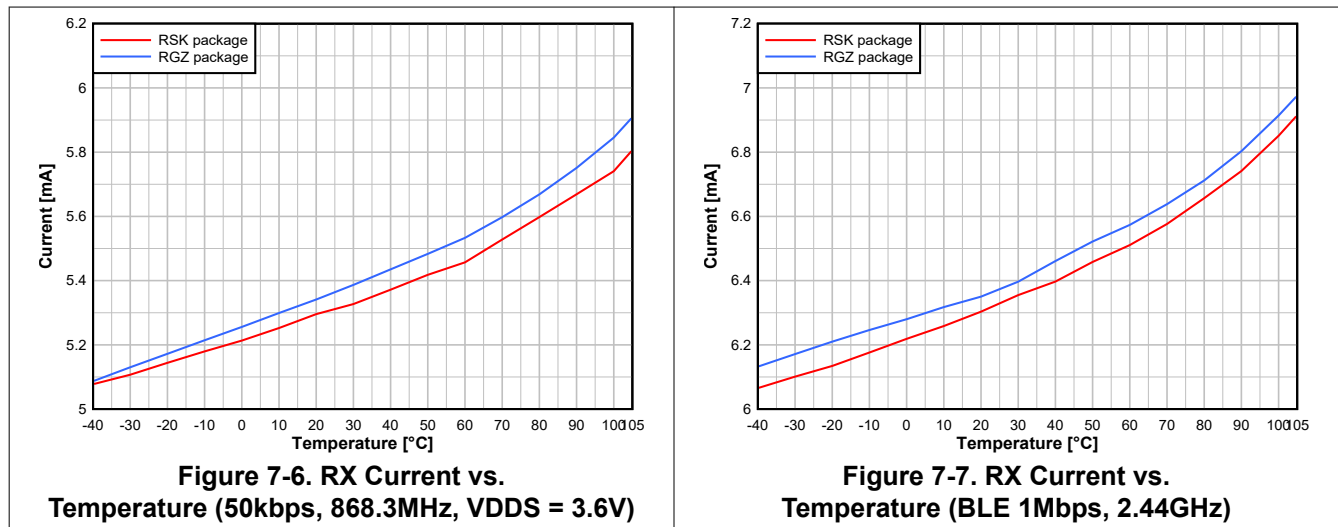

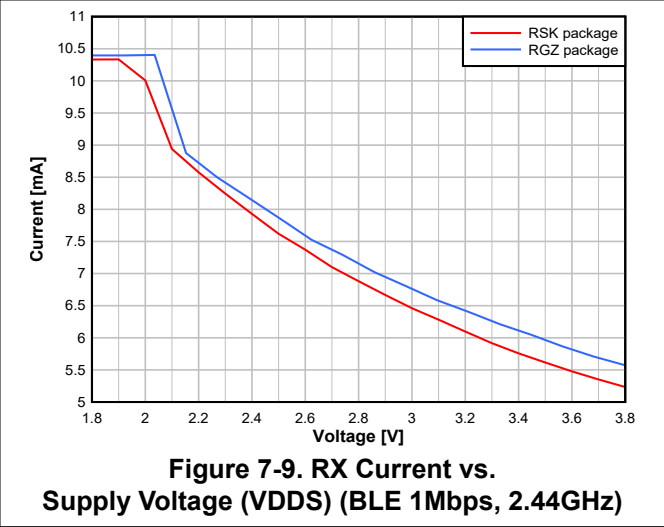
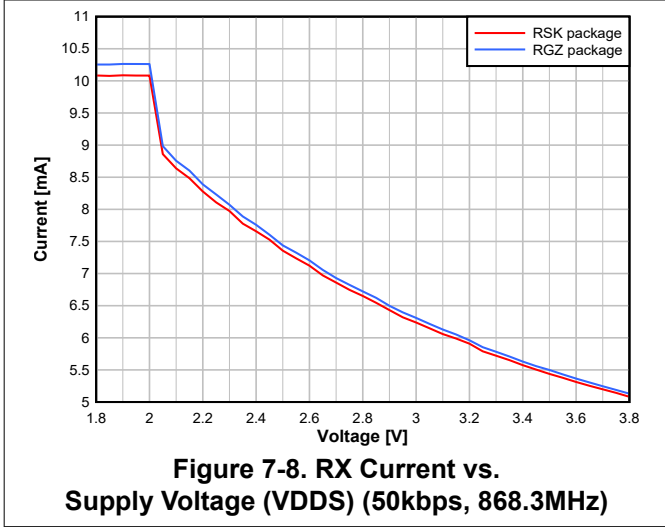

### 7.20.3 TX Current

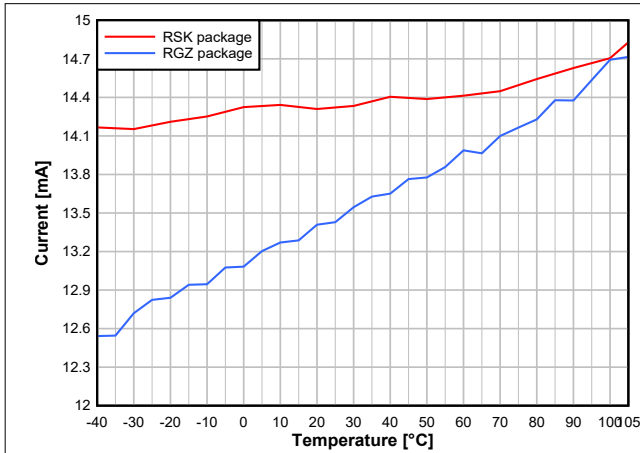

**Figure 7-10. TX Current vs. Temperature (50kbps, 868.3MHz, +10dBm, VDDS = 3.6V)**

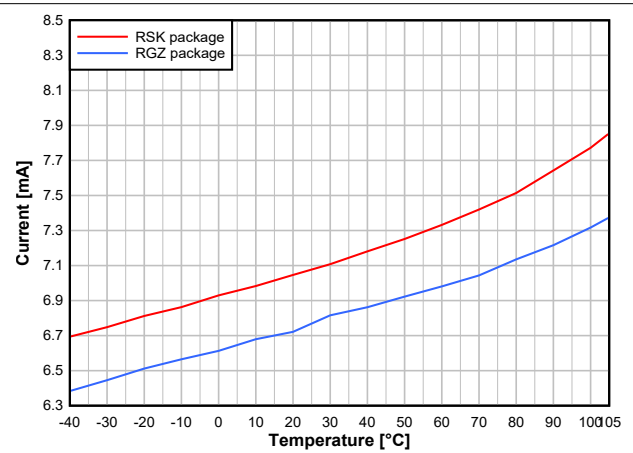

**Figure 7-11. TX Current vs. Temperature (BLE 1Mbps, 2.44GHz, 0dBm)**

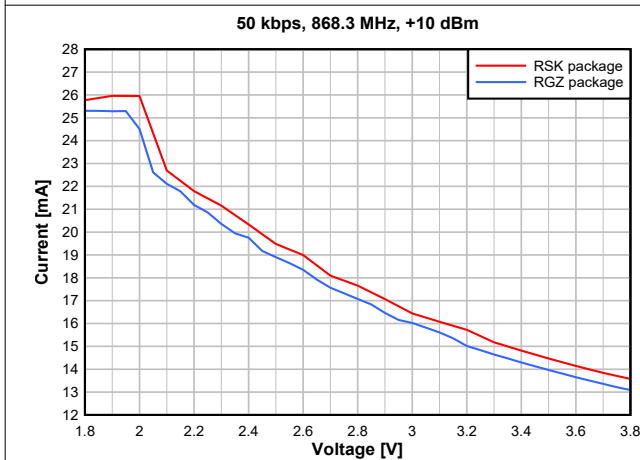

**Figure 7-12. TX Current vs. Supply Voltage (VDDS) (50kbps, 868.3MHz)**

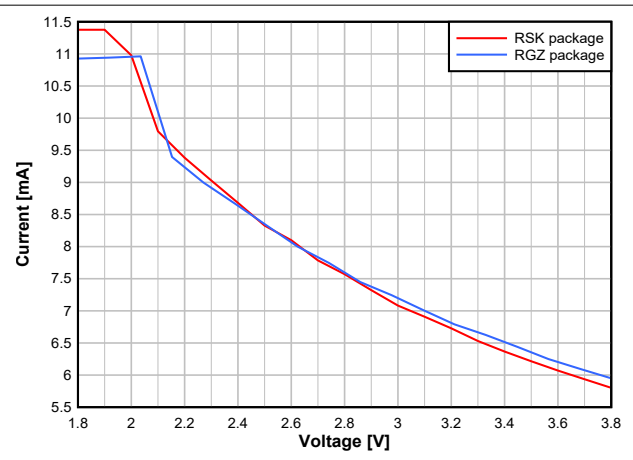

**Figure 7-13. TX Current vs. Supply Voltage (VDDS) (BLE 1 Mbps, 2.44GHz, 0dBm)**

Table 7-1 and Table 7-2 for RGZ (7 × 7) package and Table 7-3 and Table 7-4 for RSK (8 × 8) package show typical TX current and output power for different output power settings.

**Table 7-1. Typical TX Current and Output Power (868MHz, VDDS = 3.6V)**

CC1354R10 RGZ at 868MHz, VDDS = 3.6V (Measured on CC1354R10EM-7X7-XD7793-XD24)			
txPower	TX Power Setting (SmartRF Studio)	Typical Output Power [dBm]	Typical Current Consumption [mA]
0x13F	14	13.5	24.3
0xB02B	12	12.0	17.2
0x785E	11	11.0	15.1
0x2E04	10	10.1	13.5
0x70A4	9	9.0	12.6
0x16A66	8	8.0	12.2
0x14E5D	7	7.0	11.1
0x14057	6	6.1	10.4
0x5CE5	5	5.0	9.6
0x158B3	4	4.0	9.9
0x14EA9	3	3.0	9.1
0x11C4A	2	2.1	8.2
0x1329C	1	1.0	7.9
0x12A98	0	0.1	7.5
0x138F4	-1	-1.0	8.2
0x132EB	-2	-2.0	7.6
0x12AE4	-3	-3.0	7.1
0x21CA8	-4	-4.0	7.2
0x11CDA	-5	-5.0	6.3
0x116D6	-6	-6.1	6.0
0x20EF7	-7	-7.0	7.5
0x20EEF	-8	-8.0	7.0
0x20EE8	-9	-9.0	6.5
0x300AB	-10	-9.9	6.8
0x208DE	-11	-10.9	5.9
0x208DA	-12	-12.0	5.7
0x208D7	-13	-12.8	5.5
0x308F0	-14	-14.0	6.8
0x300EA	-15	-14.9	6.4
0x300E4	-16	-16.1	6.1
0x308E0	-17	-17.0	5.8
0x300DC	-18	-18.0	5.6
0x300D9	-19	-19.0	5.4
0x300D6	-20	-20.0	5.2

**Table 7-2. Typical TX Current and Output Power (2.4GHz, VDDS = 3.0V)**

CC1354R10 RGZ at 2.4GHz, VDDS = 3.0V (Measured on CC1354R10EM-7X7-XD7793-XD24)

txPower	TX Power Setting (SmartRF Studio)	Typical Output Power [dBm]	Typical Current Consumption [mA]
0x802B	5	4.3	9.2
0x661E	4	3.1	8.4
0x4E16	3	1.8	7.8
0x4011	2	0.5	7.2
0x2E5C	1	-1.5	6.6
0x209C	0	-3.6	6.1
0x2050	-3	-6.7	5.4
0x184C	-5	-9.7	5.0
0x184B	-6	-10.1	4.9
0xE8B	-9	-14.0	4.6
0x8CF	-10	-15.1	4.5
0x8CC	-12	-17.9	4.3
0x4C9	-15	-21.3	4.2
0x884	-18	-24.0	4.0
0x883	-20	-26.3	4.0

**Table 7-3. Typical TX Current and Output Power (868MHz, VDDS = 3.6V)**

CC1354R10 RSK at 868MHz, VDDS = 3.6V (Measured on LP-EM-CC1354P10-1)

txPower	TX Power Setting (SmartRF Studio)	Typical Output Power [dBm]	Typical Current Consumption [mA]
0x13F	14	13.5	25.2
0xBE33	12	12.1	18.3
0x945F	11	11.1	16.0
0x3404	10	10.1	14.2
0x78A3	9	9.2	13.5
0x5499	8	8.2	12.3
0x4693	7	7.3	11.4
0x78EC	6	6.2	11.3
0x62E3	5	5.2	10.3
0x24E77	4	4.0	11.1
0x24E6D	3	3.0	10.2
0x24665	2	2.0	9.4
0x2385F	1	1.0	8.8
0x2325A	0	-0.0	8.2
0x22A56	-1	-1.1	7.7
0x22AB6	-2	-2.0	8.7
0x22AAD	-3	-3.0	8.0
0x224A6	-4	-4.0	7.5
0x21CA1	-5	-4.9	7.1
0x21C9C	-6	-6.0	6.7
0x21CF6	-7	-6.9	7.9
0x30EB8	-8	-8.0	8.0
0x216E7	-9	-8.9	6.8
0x216E1	-10	-10.0	6.4
0x20EDD	-11	-10.8	6.1
0x20ED9	-12	-11.9	5.8

**Table 7-3. Typical TX Current and Output Power (868MHz, VDDS = 3.6V) (continued)**

CC1354R10 RSK at 868MHz, VDDS = 3.6V (Measured on LP-EM-CC1354P10-1)			
txPower	TX Power Setting (SmartRF Studio)	Typical Output Power [dBm]	Typical Current Consumption [mA]
0x20ED6	-13	-12.8	5.6
0x308EF	-14	-13.9	7.1
0x208D1	-15	-14.8	5.2
0x208FC	-16	-15.8	5.0
0x308DF	-17	-16.8	6.0
0x308DB	-18	-17.9	5.7
0x300D8	-19	-18.8	5.6
0x300D5	-20	19.9	5.3

**Table 7-4. Typical TX Current and Output Power (2.4GHz, VDDS = 3.0V)**

CC1354R10 RSK at 2.4GHz, VDDS = 3.0V (Measured on LP-EM-CC1354P10-1)			
txPower	TX Power Setting (SmartRF Studio)	Typical Output Power [dBm]	Typical Current Consumption [mA]
0x003F	5	4.7	9.4
0x8029	4	3.9	8.7
0x5C1D	3	3.0	8.1
0x4616	2	2.1	7.6
0x3263	1	1.1	7.2
0x2A5E	0	0.2	6.9
0x1CE6	-3	-2.8	6.1
0x1695	-5	-4.6	5.6
0x1693	-6	-5.6	5.4
0x0E8E	-9	-8.6	5.0
0x00D2	-10	-9.9	4.9
0x088A	-12	-12.0	4.6
0x08CC	-15	-14.6	4.4
0x00C9	-18	-17.6	4.3
0x00C7	-20	-20.2	4.1

### 7.20.4 RX Performance

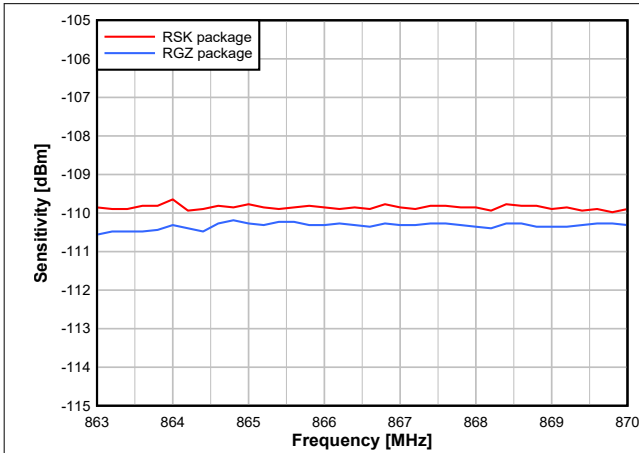

**Figure 7-14. Sensitivity vs. Frequency (50kbps, 868MHz)**

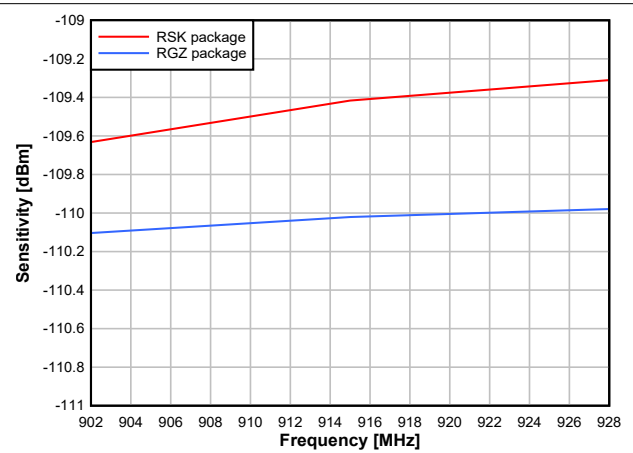

**Figure 7-15. Sensitivity vs. Frequency (50kbps, 915MHz)**

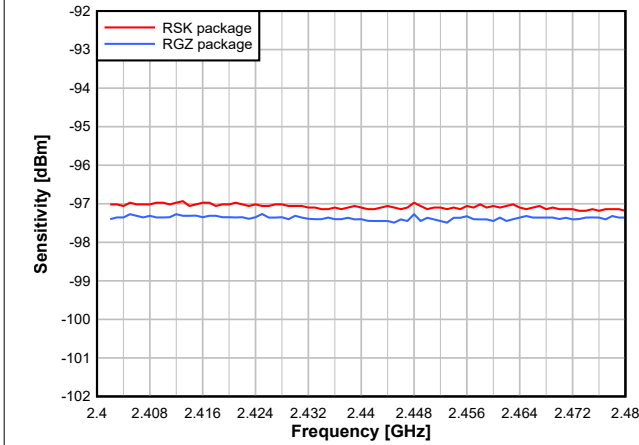

**Figure 7-16. Sensitivity vs. Frequency (BLE 1Mbps, 2.44GHz)**

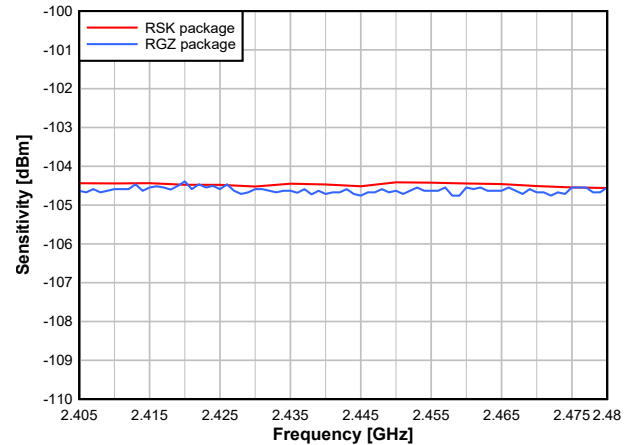

**Figure 7-17. Sensitivity vs. Frequency (IEEE 802.15.4 OQPSK DSSS1:8, 250kbps, 2.44GHz)**

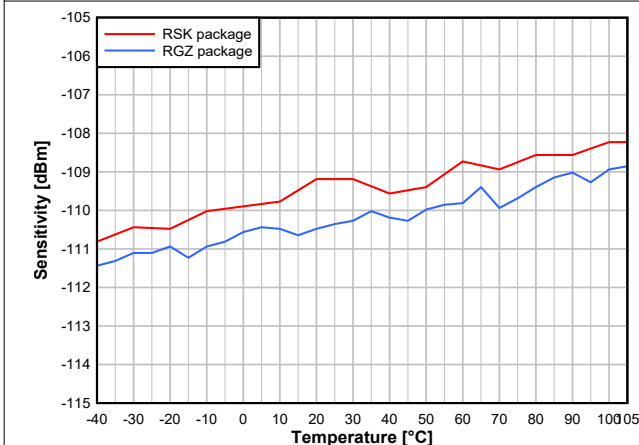

**Figure 7-18. Sensitivity vs. Temperature (50kbps, 868.3MHz)**

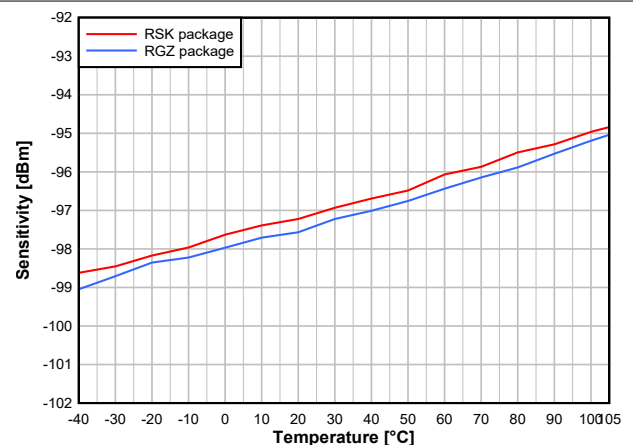

**Figure 7-19. Sensitivity vs. Temperature (BLE 1 Mbps, 2.44GHz)**

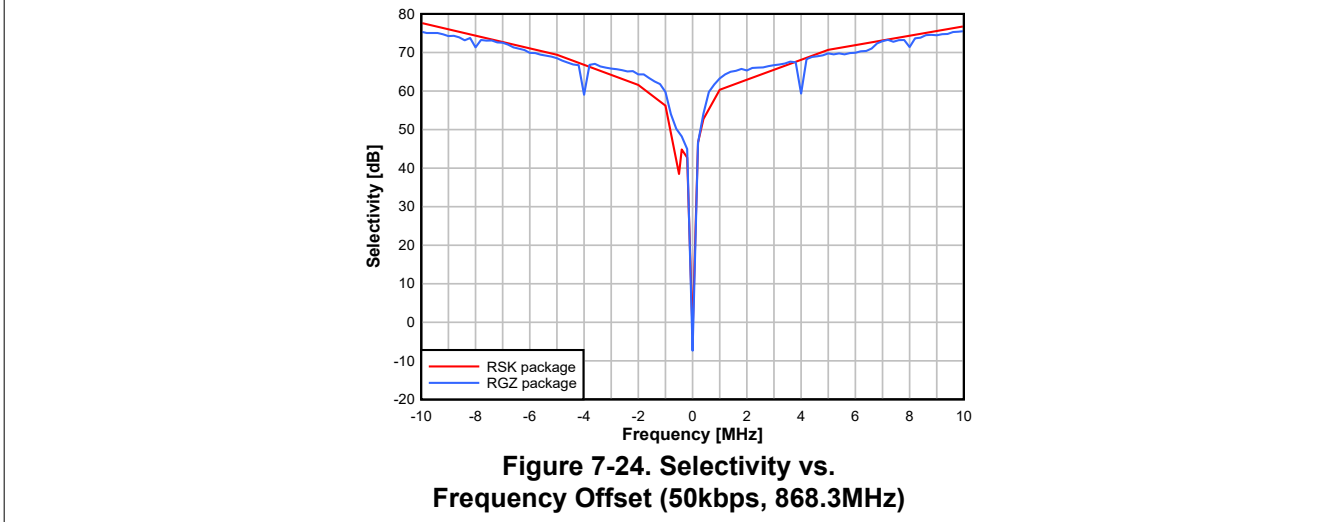
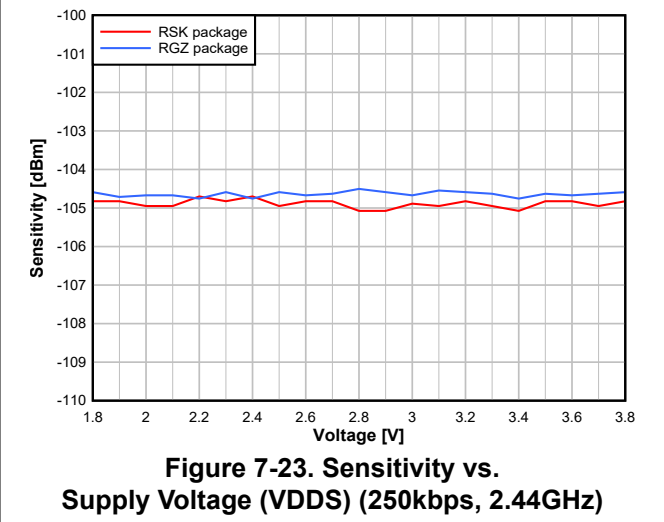
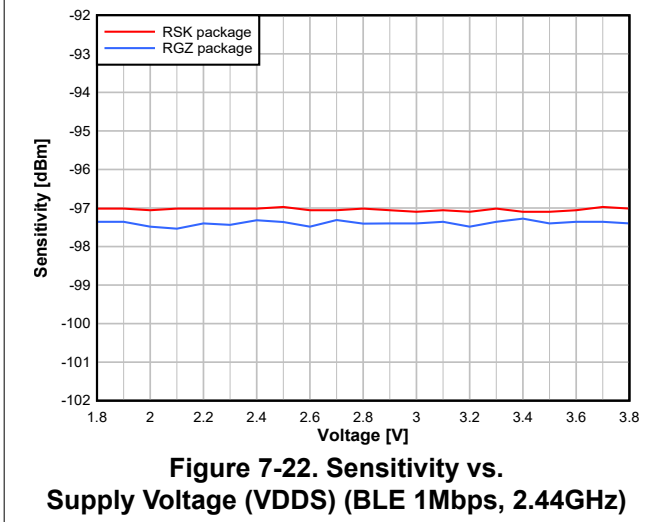
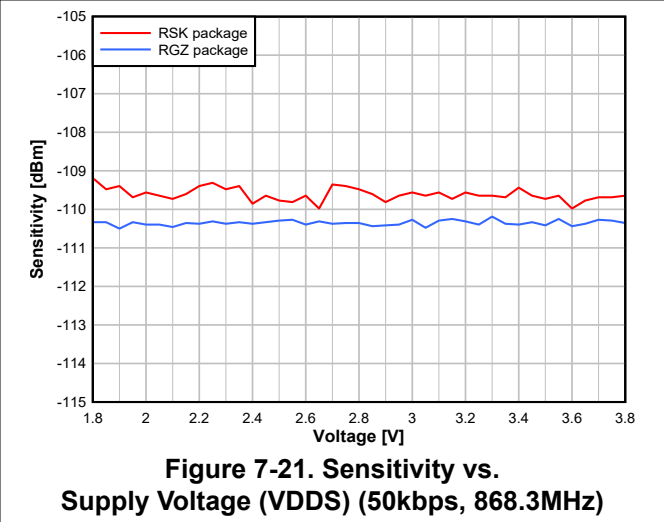
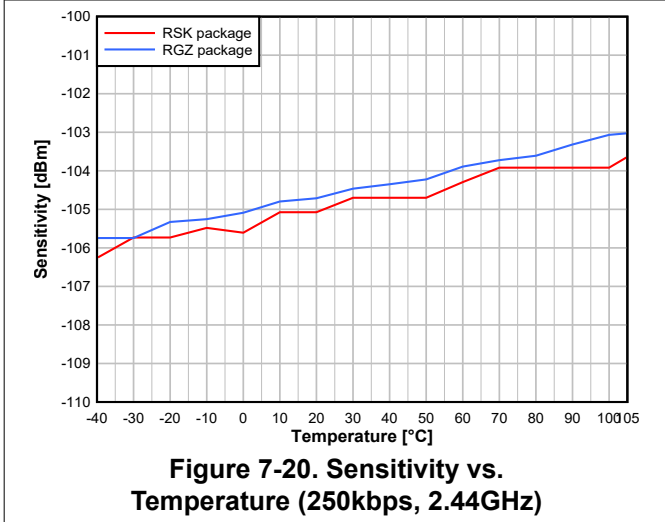

### 7.20.5 TX Performance

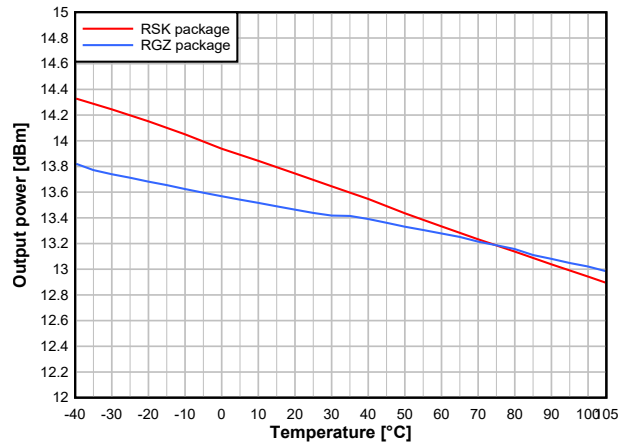

**Figure 7-25. Output Power vs. Temperature (50kbps, 868.3MHz, +14dBm)**

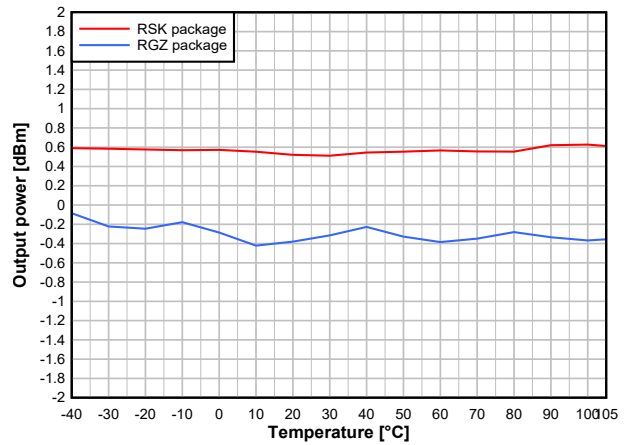

**Figure 7-26. Output Power vs. Temperature (BLE 1Mbps, 2.44GHz, 0dBm)**

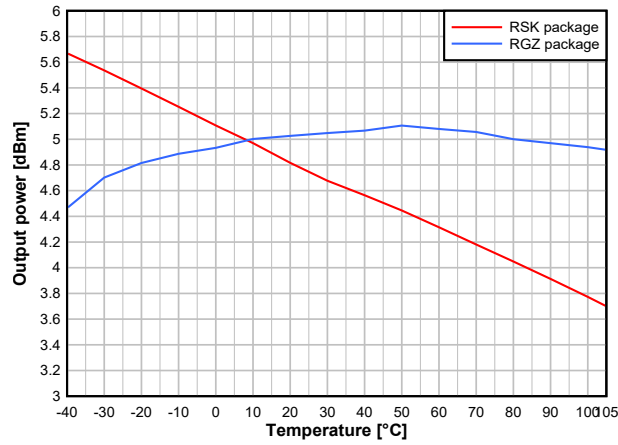

**Figure 7-27. Output Power vs. Temperature (BLE 1Mbps, 2.44GHz, +5dBm)**

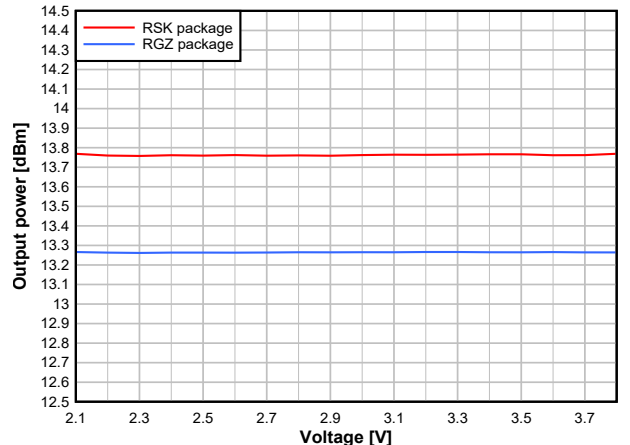

**Figure 7-28. Output Power vs. Supply Voltage (VDD5) (50kbps, 868.3MHz, +14dBm)**

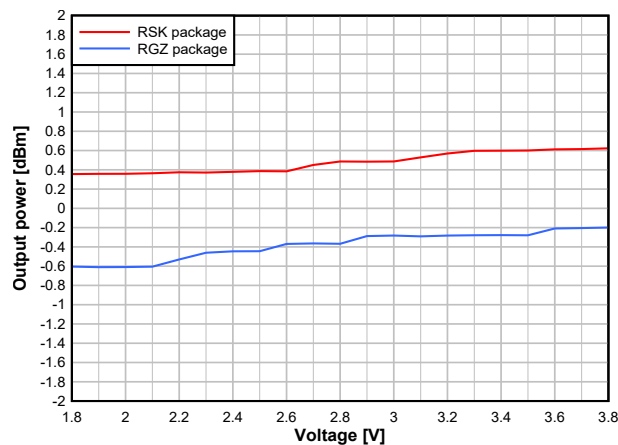

**Figure 7-29. Output Power vs. Supply Voltage (VDD5) (BLE 1Mbps, 2.44GHz, 0dBm)**

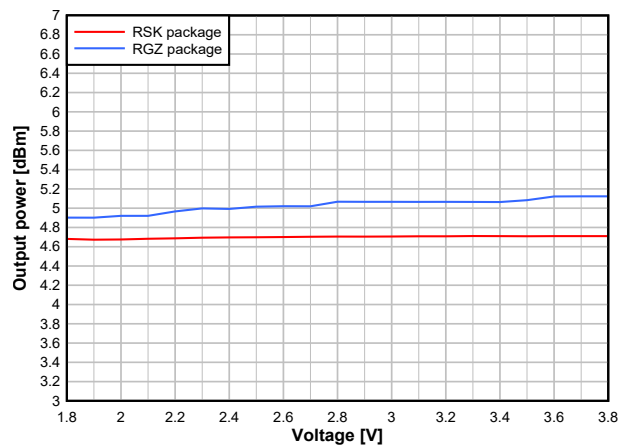

**Figure 7-30. Output Power vs. Supply Voltage (VDD5) (BLE 1Mbps, 2.44GHz, +5dBm)**

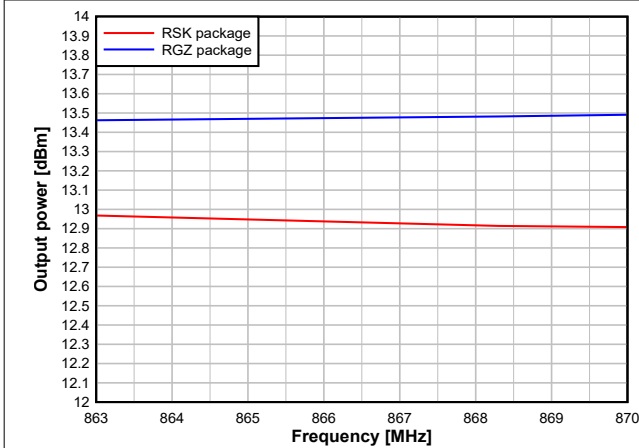

**Figure 7-31. Output Power vs. Frequency (50kbps, 868MHz, +14dBm)**

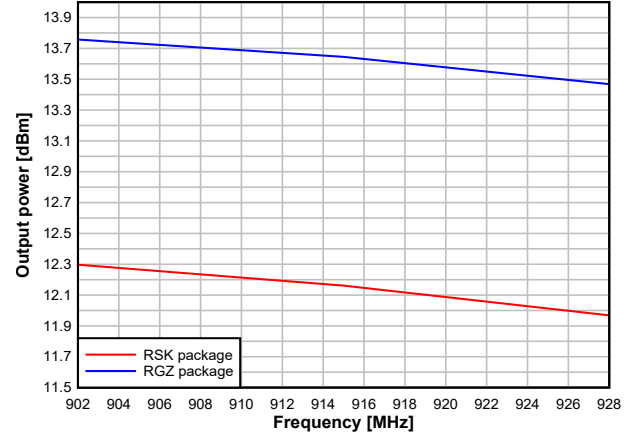

**Figure 7-32. Output Power vs. Frequency (50kbps, 915MHz, +14dBm)**

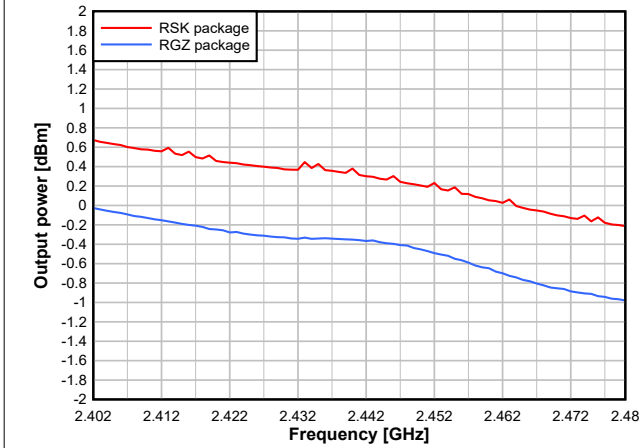

**Figure 7-33. Output Power vs. Frequency (BLE 1Mbps, 2.44GHz, 0dBm)**

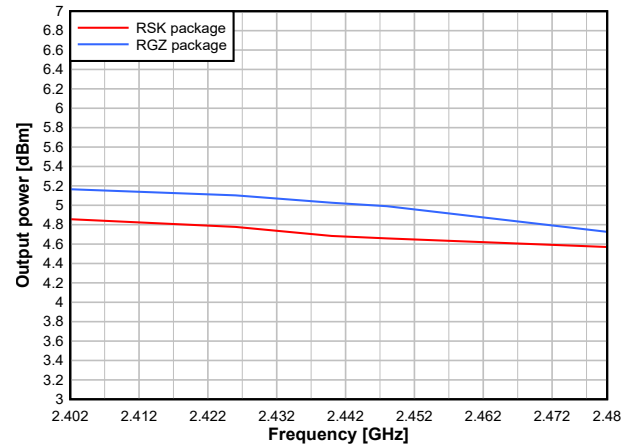

**Figure 7-34. Output Power vs. Frequency (BLE 1Mbps, 2.44GHz, +5dBm)**

### 7.20.6 ADC Performance

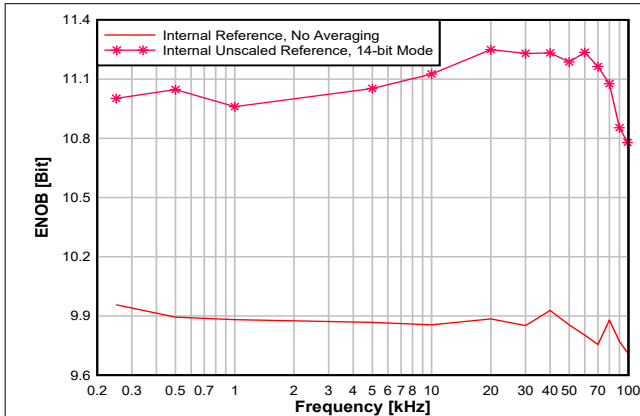

Figure 7-35. ENOB vs. Input Frequency

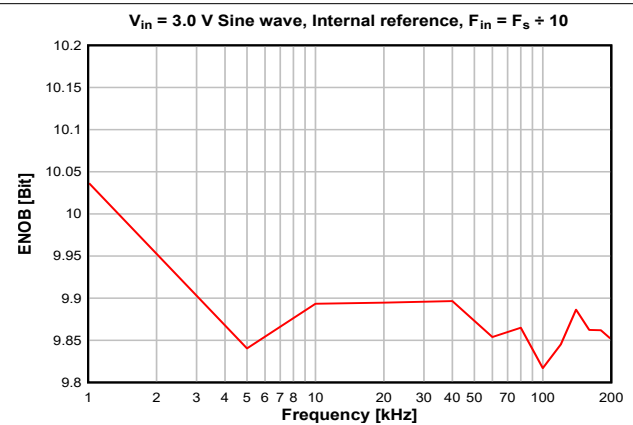

Figure 7-36. ENOB vs. Sampling Frequency

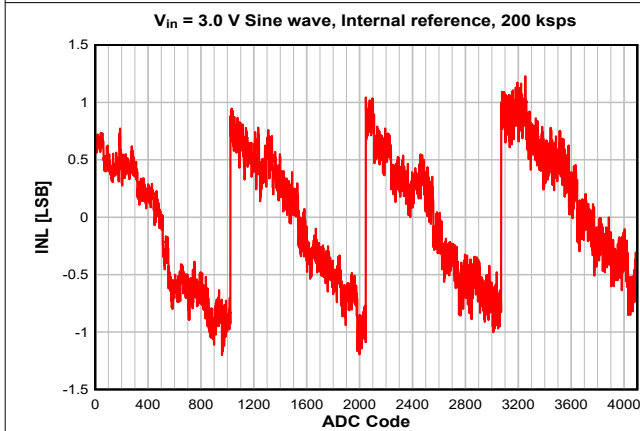

Figure 7-37. INL vs. ADC Code

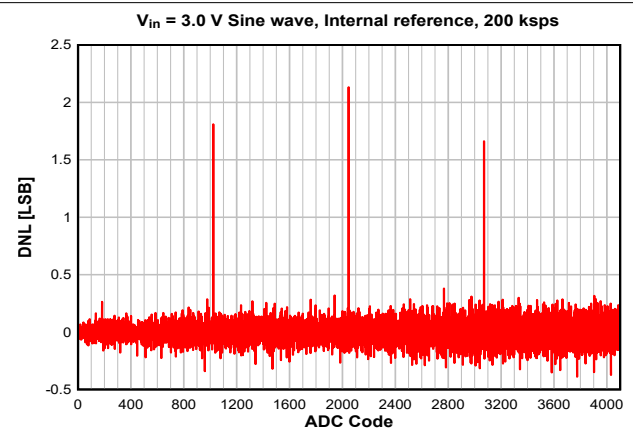

Figure 7-38. DNL vs. ADC Code

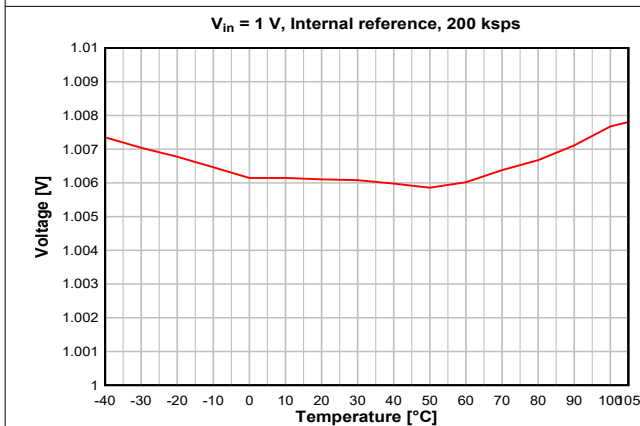

Figure 7-39. ADC Accuracy vs. Temperature

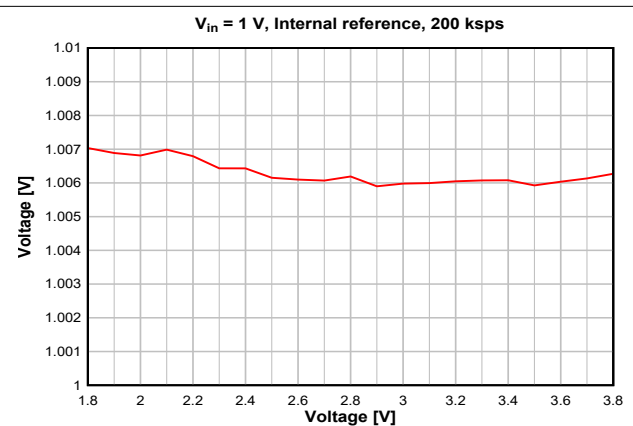

Figure 7-40. ADC Accuracy vs. Supply Voltage (VDD5)

## 8 Detailed Description

### 8.1 Overview

Figure 4-1 shows the core modules of the CC1354R10 device.

Throughout this section, see the Technical Reference Manual listed in [Section 11.2](#) for more details.

### 8.2 System CPU

The CC1354R10 SimpleLink™ Wireless MCU contains an Arm® Cortex®-M33 system CPU with TrustZone®, which runs the application and the higher layers of radio protocol stacks.

The system CPU is the foundation of a high-performance, low-cost platform that meets the system requirements of minimal memory implementation, and low power consumption while delivering outstanding computational performance and exceptional system response to interrupts.

Its features include the following:

- ARMv8-M architecture with TrustZone® security extension optimized for small-footprint embedded applications
- Arm Thumb®-2 mixed 16- and 32-bit instruction set delivers the high performance expected of a 32-bit Arm core in a compact memory size
- 8 regions of non-secure memory-protected regions
- 8 regions of secure memory-protected regions
- 4 regions of Security Attribute Unit (SAU)
- Single-cycle multiply instruction and hardware divide
- Digital signal processing (DSP) extension
- IEEE 754-compliant single-precision Floating Point Unit (FPU)
- Fast code execution permits increased sleep mode time
- Deterministic, high-performance interrupt handling for time-critical applications
- Full debug with data matching for watchpoint generation
  - Data Watchpoint and Trace Unit (DWT)
  - JTAG Debug Access Port (DAP)
  - Flash Patch and Breakpoint Unit (FPB)
- Trace support reduces the number of pins required for debugging and tracing
  - Instrumentation Trace Macrocell Unit (ITM)
  - Trace Port Interface Unit (TPIU) with asynchronous serial wire output (SWO)
- Optimized for single-cycle flash memory access
- Tightly connected to 8kB 4-way random replacement cache for minimal active power consumption and wait states
- Ultra-low-power consumption with integrated sleep modes
- 48MHz operation

### 8.3 Radio (RF Core)

The RF Core is a highly flexible and future-proof radio module that contains an Arm Cortex-M0 processor that interfaces the analog RF and base-band circuitry, handles data to and from the system CPU side, and assembles the information bits in a given packet structure. The RF core offers a high-level, command-based API to the main CPU that configurations and data are passed through. The Arm Cortex-M0 processor is not programmable by customers and is interfaced through the TI-provided RF driver that is included with the SimpleLink Software Development Kit (SDK).

The RF core can autonomously handle the time-critical aspects of the radio protocols, thus offloading the main CPU, which reduces power and leaves more resources for the user application. Several signals are also available to control external circuitry such as RF switches or range extenders autonomously.

Dual-band and multiprotocol solutions are enabled through time-sliced access to the radio, handled transparently for the application through the TI-provided RF driver and dual-mode manager.

The various physical layer radio formats are partly built as a software-defined radio where the radio behavior is either defined by radio ROM contents or by non-ROM radio formats delivered in the form of firmware patches with the SimpleLink SDKs. This allows the radio platform to be updated for support of future versions of standards even with over-the-air (OTA) updates while still using the same silicon.

---

#### Note

Not all combinations of features, frequencies, data rates, and modulation formats described in this chapter are supported. Over time, TI can enable new physical radio formats (PHYs) for the device and provides performance numbers for selected PHYs in the data sheet. Supported radio formats for a specific device, including optimized settings to use with the TI RF driver, are included in the [SmartRF Studio](#) tool with performance numbers of selected formats found in [Section 7](#).

---

### 8.3.1 Proprietary Radio Formats

The CC1354R10 radio can support a wide range of physical radio formats through a set of hardware peripherals combined with firmware available in the device ROM, covering various customer needs for optimizing parameters such as speed or sensitivity. This allows great flexibility in tuning the radio both to work with legacy protocols as well as customizing the behavior for specific application needs.

Table 8-1 gives a simplified overview of features of the various radio formats available in ROM. Other radio formats may be available in the form of radio firmware patches or programs through the software development kit (SDK) and may combine features in a different manner, as well as add other features.

**Table 8-1. Feature Support**

Feature	Main 2-(G)FSK Mode	High Data Rates	Low Data Rates	SimpleLink™ Long Range
Programmable preamble, sync word and CRC	Yes	Yes	Yes	No
Programmable receive bandwidth	Yes	Yes	Yes (down to 4 kHz)	Yes
Data / Symbol rate <sup>(3)</sup>	20 to 1000kbps	≤ 2 Msps	≤ 100 ksps	≤ 20 ksps
Modulation format	2-(G)FSK	2-(G)FSK 4-(G)FSK	2-(G)FSK 4-(G)FSK	2-(G)FSK
Dual Sync Word	Yes	Yes	No	No
Carrier Sense <sup>(1)</sup> <sup>(2)</sup>	Yes	No	No	No
Preamble Detection <sup>(2)</sup>	Yes	Yes	Yes	No
Data Whitening	Yes	Yes	Yes	Yes
Digital RSSI	Yes	Yes	Yes	Yes
CRC filtering	Yes	Yes	Yes	Yes
Direct-sequence spread spectrum (DSSS)	No	No	No	1:2 1:4 1:8
Forward error correction (FEC)	No	No	No	Yes
Link Quality Indicator (LQI)	Yes	Yes	Yes	Yes

- (1) Carrier Sense can be used to implement HW-controlled listen-before-talk (LBT) and Clear Channel Assessment (CCA) for compliance with such requirements in regulatory standards. This is available through the CMD\_PROP\_CS radio API.
- (2) Carrier Sense and Preamble Detection can be used to implement sniff modes where the radio is duty-cycled to save power.
- (3) Data rates are only indicative. Data rates outside this range may also be supported. For some specific combinations of settings, a smaller range might be supported.

### 8.3.2 Bluetooth 5.3 Low Energy

The RF Core offers full support for Bluetooth 5.3 Low Energy, including the high-speed 2Mbps physical layer and the 500kbps and 125kbps long-range PHYs (coded PHY) through the TI-provided Bluetooth 5.3 stack or a high-level Bluetooth API. The Bluetooth 5.3 PHY and part of the controller are in radio and system ROM, providing significant savings in memory usage and more space available for applications.

The new high-speed mode allows data transfers up to 2Mbps, twice the speed of Bluetooth 4.2 and five times the speed of Bluetooth 4.0, without increasing power consumption. In addition to faster speeds, this mode offers significant improvements for energy efficiency and wireless coexistence with reduced radio communication time.

Bluetooth 5.3 also enables unparalleled flexibility for adjustment of speed and range based on application needs, which capitalizes on the high-speed or long-range modes respectively. Data transfers are now possible at 2Mbps, enabling the development of applications using voice, audio, imaging, and data logging that were not previously an option using Bluetooth low energy. With high-speed mode, existing applications deliver faster responses, richer engagement, and longer battery life. Bluetooth 5.3 enables fast, reliable firmware updates.

### 8.3.3 802.15.4 Thread, Zigbee, and 6LoWPAN

Through a dedicated IEEE radio API, the RF Core supports the 2.4GHz IEEE 802.15.4-2011 physical layer (2 Mchips per second Offset-QPSK with DSSS 1:8), used in Thread, Zigbee, and 6LoWPAN protocols. The 802.15.4 PHY and MAC are in radio and system ROM. TI also provides royalty-free protocol stacks for Thread and Zigbee as part of the SimpleLink SDK, enabling a robust end-to-end solution.

## 8.4 Memory

1024kB nonvolatile (Flash) memory provides storage for code and data in two banks. The flash memory is in-system programmable and erasable. The last flash memory sector must contain a Customer Configuration section (CCFG) that is used by boot ROM and TI-provided drivers to configure the device. This configuration is done through the `ccfg.c` source file that is included in all TI-provided examples.

The ultra-low leakage system static RAM (SRAM) is split into up to eight 32kB blocks and can be used for both storage of data and execution of code. Retention of SRAM contents in Standby power mode is enabled by default and included in Standby mode power consumption numbers. Parity checking for detection of bit errors in memory is built-in, which reduces chip-level soft errors and thereby increases reliability. Parity can be disabled for an additional 32kB that can be allocated for general-purpose SRAM. System SRAM is always initialized to zeroes upon code execution from boot.

To improve code execution speed and lower power when executing code from nonvolatile memory, a 4-way nonassociative 8kB cache is enabled by default to cache and prefetch instructions read by the system CPU. The cache can be used as a general-purpose RAM by enabling this feature in the Customer Configuration Area (CCFG).

There is a 4kB ultra-low leakage SRAM available for use with the Sensor Controller Engine which is typically used for storing Sensor Controller programs, data, and configuration parameters. This RAM is also accessible by the system CPU. The Sensor Controller RAM is not cleared to zeroes between system resets.

The ROM includes a TI-RTOS kernel and low-level drivers, as well as significant parts of selected radio stacks, which free up flash memory for the application. The ROM also contains a serial (SPI and UART) bootloader that can be used for the initial programming of the device.

## 8.5 Sensor Controller

The Sensor Controller contains circuitry that can be selectively enabled in both Standby and Active power modes. The peripherals in this domain can be controlled by the Sensor Controller Engine, which is a proprietary power-optimized CPU. This CPU can read and monitor sensors or perform other tasks autonomously; thereby significantly reducing power consumption and offloading the system CPU.

The Sensor Controller Engine is user-programmable with a simple programming language that has syntax similar to C. This programmability allows for sensor polling and other tasks to be specified as sequential algorithms rather than the static configuration of complex peripheral modules, timers, DMA, register programmable state machines, or event routing.

The main advantages are:

- Flexibility—Data can be read and processed in unlimited manners while still ensuring ultra-low power.
- 2MHz low-power mode enables the lowest possible handling of digital sensors
- Dynamic reuse of hardware resources
- 40-bit accumulator supporting multiplication, addition, and shift
- Observability and debugging options

[Sensor Controller Studio](#) is used to write, test, and debug code for the Sensor Controller. The tool produces C driver source code, which the System CPU application uses to control and exchange data with the Sensor Controller. Typical use cases may be (but are not limited to) the following:

- Read analog sensors using integrated ADC or comparators
- Interface digital sensors using GPIOs, SPI, UART, or I<sup>2</sup>C (UART and I<sup>2</sup>C are bit-banged)
- Capacitive sensing
- Waveform generation
- Very low-power pulse counting (flow metering)
- Key scan

The peripherals in the Sensor Controller include the following:

- The low-power clocked comparator can be used to wake the system CPU from any state in which the comparator is active. A configurable internal reference DAC can be used in conjunction with the comparator. The output of the comparator can also be used to trigger an interrupt or the ADC.
- Capacitive sensing functionality is implemented through the use of a constant current source, a time-to-digital converter, and a comparator. The continuous time comparator in this block can also be used as a higher-accuracy alternative to the low-power clocked comparator. The Sensor Controller takes care of baseline tracking, hysteresis, filtering, and other related functions when these modules are used for capacitive sensing.
- The ADC is a 12-bit 200ksps ADC with eight inputs and a built-in voltage reference. The ADC can be triggered by many different sources including timers, I/O pins, software, and comparators.
- The analog modules can connect to up to eight different GPIOs.
- Dedicated SPI master with up to 6MHz clock speed.

The peripherals in the Sensor Controller can also be controlled from the main application processor.

## 8.6 Cryptography

The CC1354R10 device comes with a wide set of modern cryptography-related hardware accelerators, drastically reducing code footprint and execution time for cryptographic operations. It also has the benefit of being lower power and improves availability and responsiveness of the system because the cryptography operations runs in a background hardware thread.

Together with a large selection of open-source cryptography libraries provided with the software development kit (SDK), this allows for secure and future proof IoT applications to be easily built on top of the platform. The hardware accelerator modules are:

- **True Random Number Generator (TRNG)** module provides a true, nondeterministic noise source for the purpose of generating keys, initialization vectors (IVs), and other random number requirements. The TRNG is built on 24 ring oscillators that create unpredictable output to feed a complex nonlinear-combinatorial circuit.
- **Secure Hash Algorithm 2 (SHA-2)** with support for SHA224, SHA256, SHA384, and SHA512.
- **Advanced Encryption Standard (AES)** with 128-bit, 192-bit, and 256-bit key lengths.
- **Public Key Accelerator**—Hardware accelerator supporting mathematical operations needed for elliptic curves up to 512 bits.

Through use of these modules and the TI provided cryptography drivers, the following capabilities are available for an application or stack:

- **Key Agreement Schemes**
  - Elliptic Curve Diffie–Hellman with static or ephemeral keys (ECDH and ECDHE)
  - Elliptic curve Password Authenticated Key Exchange by Juggling (ECJ-PAKE)
- **Signature Processing**
  - Elliptic curve Diffie–Hellman Digital Signature Algorithm (ECDSA)
  - Edwards-curve Digital Signature Algorithm (EdDSA)
- **Curve Support**
  - Short Weierstrass form, such as:
    - NIST-P224 (secp224r1), NIST-P256 (secp256r1), NIST-P384 (secp384r1), NIST-P521 (secp521r1)
    - Brainpool-256R1, Brainpool-384R1, Brainpool-512R1
  - Montgomery form, such as:
    - Curve25519
  - Twisted Edwards form, such as:
    - Ed25519
- **Message Authentication Codes**
  - AEC CBC-MAC
  - AES CMAC
  - HMAC with SHA224, SHA256, SHA384, and SHA512
- **Block cipher mode of operation**

- AES CCM and AES CCM-Star
- AES GCM
- AES ECB
- AES CBC
- AES CTR
- **Hash Algorithm**
  - SHA224
  - SHA256
  - SHA384
  - SHA512
- **True random number generation**

Other capabilities, such as RSA encryption and signatures (using keys as large as 2048 bits) as well as other ECC curves such as Curve1174, can be implemented using the provided public key accelerator but are not part of the TI SimpleLink SDK for the CC1354R10 device.

## 8.7 Timers

A large selection of timers are available as part of the CC1354R10 device. These timers are:

- **Real-Time Clock (RTC)**

A 70-bit 3-channel timer running on the 32kHz low-frequency system clock (SCLK\_LF). This timer is available in all power modes except Shutdown. The timer can be calibrated to compensate for frequency drift when using the LF RCOSC as the low-frequency system clock. If an external LF clock with a frequency different from 32.768kHz is used, the RTC tick speed can be adjusted to compensate for this. When using TI-RTOS, the RTC is used as the base timer in the operating system and should thus only be accessed through the kernel APIs such as the Clock module. The real-time clock can also be read by the Sensor Controller Engine to timestamp sensor data and also has dedicated capture channels. By default, the RTC halts when a debugger halts the device.

- **General Purpose Timers (GPTIMER)**

The four flexible GPTIMERS can be used as either 4 × 32-bit timers or 8 × 16-bit timers, all running on up to 48MHz. Each of the 16- or 32-bit timers supports a wide range of features such as one-shot or periodic counting, pulse width modulation (PWM), time counting between edges, and edge counting. The inputs and outputs of the timer are connected to the device event fabric, which allows the timers to interact with signals such as GPIO inputs, other timers, DMA, and ADC. The GPTIMERS are available in Active and Idle power modes.

- **Sensor Controller Timers**

The Sensor Controller contains three timers:

The Sensor Controller contains three timers: AUX Timers 0 and 1 are 16-bit timers with a  $2^N$  prescaler. Timers can either increment on a clock or each edge of a selected tick source. Both one-shot and periodical timer modes are available.

AUX Timer 2 is a 16-bit timer that can operate at 24MHz, 2MHz, or 32kHz independent of the Sensor Controller functionality. There are four capture or compare channels, which can be operated in one-shot or periodical modes. The timer can be used to generate events for the Sensor Controller Engine or the ADC, as well as for PWM output or waveform generation.

- **Radio Timer**

A multichannel 32-bit timer running at 4MHz is available as part of the device radio. The radio timer is typically used as the timing base in wireless network communication using the 32-bit timing word as the network time. The radio timer is synchronized with the RTC by using a dedicated radio API when the device radio is turned on or off. This ensures that for a network stack, the radio timer seems to always be running when the radio is enabled. The radio timer is in most cases used indirectly through the trigger time fields

in the radio APIs and should only be used when running the accurate 48MHz high-frequency crystal is the source of SCLK\_HF.

- **Watchdog Timer**

The watchdog timer is used to regain control if the system operates incorrectly due to software errors. It is typically used to generate an interrupt and reset the device for the case where periodic monitoring of the system components and tasks fails to verify proper functionality. The watchdog timer runs on a 1.5MHz clock rate and cannot be stopped once enabled. The watchdog timer continues to run in Standby power mode but pauses when a debugger halts the device.

- **Always On Watchdog Timer (AON\_WDT)**

The Always On Watchdog Timer is used during standby to regain control when the system has failed due to a software error or failure of an external device to respond in the expected way. It generates a reset when its configured time-out counter reaches zero and cannot be stopped once started, unless by asserting a device reset. The Always-on watchdog timer runs in Standby power mode and may pause when a debugger halts the device.

## 8.8 Serial Peripherals and I/O

The SPI interface provides a standardized synchronous serial interface to communicate with devices compatible with SPI (3 and 4 wire), MICROWIRE and TI Synchronous Serial Format. The SPIs support master/slave operation up to 12MHz, programmable clock bit rate with prescaler, as well as configurable phase and polarity.

The UART interface implements universal asynchronous receiver and transmitter functions. The UART supports flexible baud-rate generation up to a maximum of 3Mbps with FIFO, multiple data sizes, stop, and parity bits as well as hardware handshake.

The I<sup>2</sup>S interface provides a standardized interface to exchange digital audio with devices compatible with this standard, including ADCs, DACs, and CODECs. The I<sup>2</sup>S can also receive pulse-density modulation (PDM) data from devices such as digital microphones and perform conversion to PCM data.

The I<sup>2</sup>C interface enables low-speed serial communications with devices compatible with the I<sup>2</sup>C standard. The I<sup>2</sup>C interface can handle both standard (100kHz) and fast (400kHz) speeds, as well as four modes of operation: master transmit/receive and slave transmit/receive.

The I/O controller (IOC) controls the digital I/O pins and contains multiplexer circuitry to allow a set of peripherals to be assigned to I/O pins in a flexible manner. All digital I/Os are interrupt and wake-up capable, have a programmable pullup and pulldown function, and can generate an interrupt on a negative or positive edge (configurable). When configured as an output, pins can function as either push-pull or open-drain. Five GPIOs have high-drive capabilities, which are marked in **bold** in [Section 6](#). All digital peripherals can be connected to any digital pin on the device.

## 8.9 Battery and Temperature Monitor

A combined temperature and battery voltage monitor is available in the CC1354R10 device. The battery and temperature monitor allows an application to continuously monitor on-chip temperature and supply voltage and respond to changes in environmental conditions as needed. The module contains window comparators to interrupt the system CPU when temperature or supply voltage goes outside defined windows. These events can also be used to wake up the device from Standby mode through the always-on (AON) event fabric.

## 8.10 $\mu$ DMA

The device includes a direct memory access ( $\mu$ DMA) controller. The  $\mu$ DMA controller provides a way to offload data-transfer tasks from the system CPU, thus allowing for more efficient use of the processor and the available bus bandwidth. The  $\mu$ DMA controller can perform a transfer between memory and peripherals. The  $\mu$ DMA controller has dedicated channels for each supported on-chip module and can be programmed to automatically perform transfers between peripherals and memory when the peripheral is ready to transfer more data.

Some features of the  $\mu$ DMA controller include the following (this is not an exhaustive list):

- Highly flexible and configurable channel operation of up to 32 channels
- Transfer modes: memory-to-memory, memory-to-peripheral, peripheral-to-memory, and peripheral-to-peripheral
- Data sizes of 8 bits, 16 bits, and 32 bits
- Ping-pong mode for continuous streaming of data

## 8.11 Debug

The debug subsystem implements two IEEE standards for debug and test purposes:

IEEE 1149.7 Class 4: Reduced-pin and Enhanced-functionality Test Access Port and Boundary-scan Architecture. This is known by the acronym cJTAG (compact JTAG) and this device uses only two pins to communicate with the target: TMS (JTAG\_TMSC) and TCK (JTAG\_TCKC). This is the default mode of operation.

IEEE standard 1149.1: Test Access Port and Boundary Scan Architecture Test Access Port (TAP). This standard is known by the acronym JTAG and this device uses four pins to communicate with the target: TMS (JTAG\_TMSC), TCK (JTAG\_TCKC), TDI (JTAG\_TDI), and TDO (JTAG\_TDO).

The debug subsystem also implements a user-configurable firewall to control unauthorized access to debug/test ports.

Also featured is **EnergyTrace/EnergyTrace++**. This technology implements an improved method for measuring MCU current consumption, which features a very high dynamic range (from sub- $\mu$ A to hundreds of mA), high sample rate (up to 256 kSamples/s), and the ability to track the CPU and peripheral power states.

Two modes of operation can be configured. **EnergyTrace** measures the overall MCU current consumption and allows maximum accuracy and speed to track ultra-low-power states as well as the fast power transitions during radio transmission and reception. **EnergyTrace++** tracks the various power states of both the CPU and its Peripherals as well as the system clocks, allowing close monitoring of the overall device activity.

## 8.12 Power Management

To minimize power consumption, the CC1354R10 supports a number of power modes and power management features (see [Table 8-2](#)).

**Table 8-2. Power Modes**

MODE	SOFTWARE CONFIGURABLE POWER MODES				RESET PIN HELD
	ACTIVE	IDLE	STANDBY	SHUTDOWN	
CPU	Active	Off	Off	Off	Off
Flash	On	Available	Off	Off	Off
SRAM	On	On	Retention	Off	Off
Supply System	On	On	Duty Cycled	Off	Off
Register and CPU retention	Full	Full	Partial	No	No
SRAM retention	Full	Full	Full	No	No
48MHz high-speed clock (SCLK_HF)	XOSC_HF or RCOSC_HF	XOSC_HF or RCOSC_HF	Off	Off	Off
2MHz medium-speed clock (SCLK_MF)	RCOSC_MF	RCOSC_MF	Available	Off	Off
32kHz low-speed clock (SCLK_LF)	XOSC_LF or RCOSC_LF	XOSC_LF or RCOSC_LF	XOSC_LF or RCOSC_LF	Off	Off
Peripherals	Available	Available	Off	Off	Off
Sensor Controller	Available	Available	Available	Off	Off
Wake-up on RTC	Available	Available	Available	Off	Off
Wake-up on pin edge	Available	Available	Available	Available	Off
Wake-up on reset pin	On	On	On	On	On
Brownout detector (BOD)	On	On	Duty Cycled	Off	Off
Power-on reset (POR)	On	On	On	Off	Off
Watchdog timer (WDT)	Available	Available	Paused	Off	Off
Always-on Watchdog timer (AON_WDT)	Available	Available	Available	Off	Off

In **Active** mode, the application system CPU is actively executing code. Active mode provides normal operation of the processor and all of the peripherals that are currently enabled. The system clock can be any available clock source (see [Table 8-2](#)).

In **Idle** mode, all active peripherals can be clocked, but the Application CPU core and memory are not clocked and no code is executed. Any interrupt event brings the processor back into active mode.

In **Standby** mode, only the always-on (AON) domain is active. An external wake-up event, RTC event, or Sensor Controller event is required to bring the device back to active mode. MCU peripherals with retention do not need to be reconfigured when waking up again, and the CPU continues execution from where it went into standby mode. All GPIOs are latched in standby mode.

In **Shutdown** mode, the device is entirely turned off (including the AON domain and Sensor Controller), and the I/Os are latched with the value they had before entering shutdown mode. A change of state on any I/O pin defined as a *wake from shutdown pin* wakes up the device and functions as a reset trigger. The CPU can differentiate between reset in this way and reset-by-reset pin or power-on reset by reading the reset status register. The only state retained in this mode is the latched I/O state and the flash memory contents.

The Sensor Controller is an autonomous processor that can control the peripherals in the Sensor Controller independently of the system CPU. This means that the system CPU does not have to wake up, for example, to perform an ADC sampling or poll a digital sensor over SPI, thus saving both current and wake-up time that would otherwise be wasted. The [Sensor Controller Studio](#) tool enables the user to program the Sensor Controller, control its peripherals, and wake up the system CPU as needed. All Sensor Controller peripherals can also be controlled by the system CPU.

---

#### Note

The power, RF, and clock management for the CC1354R10 device require specific configuration and handling by software for optimized performance. This configuration and handling is implemented in the TI-provided drivers that are part of the CC1354R10 software development kit (SDK). Therefore, TI highly recommends using this software framework for all application development on the device. The complete SDK with TI-RTOS (optional), device drivers, and examples is offered free of charge in the source code.

---

### 8.13 Clock Systems

The CC1354R10 device has several internal system clocks.

The 48MHz SCLK\_HF is used as the main system (MCU and peripherals) clock. This can be driven by the internal 48MHz RC Oscillator (RCOSC\_HF) or an external 48MHz crystal (XOSC\_HF). Radio operation requires an external 48MHz crystal.

SCLK\_MF is an internal 2MHz clock that is used by the Sensor Controller in low-power mode and also for internal power management circuitry. The SCLK\_MF clock is always driven by the internal 2MHz RC oscillator (RCOSC\_MF).

SCLK\_LF is the 32.768kHz internal low-frequency system clock. It can be used by the Sensor Controller for ultra-low-power operation and is also used for the RTC and to synchronize the radio timer before or after Standby power mode. SCLK\_LF can be driven by the internal 32.8kHz RC Oscillator (RCOSC\_LF), a 32.768kHz watch-type crystal, or a clock input on any digital IO.

When using a crystal or the internal RC oscillator, the device can output the 32kHz SCLK\_LF signal to other devices, thereby reducing the overall system cost.

### 8.14 Network Processor

Depending on the product configuration, the CC1354R10 device can function as a wireless network processor (WNP), a device running the wireless protocol stack with the application running on a separate host MCU, or as a system-on-chip (SoC) with the application and protocol stack running on the system CPU inside the device.

In the first case, the external host MCU communicates with the device using SPI or UART. In the second case, the application must be written according to the application framework supplied with the wireless protocol stack.

## 9 Application, Implementation, and Layout

---

### Note

Information in the following Applications section is not part of the TI component specification, and TI does not warrant its accuracy or completeness. TI's customers are responsible for determining suitability of components for their purposes. Customers should validate and test their design implementation to confirm system functionality.

---

For general design guidelines and hardware configuration guidelines, refer to [CC13xx/CC26xx Hardware Configuration and PCB Design Considerations Application Report](#).

### 9.1 Reference Designs

The following reference designs should be followed closely when implementing designs using the CC1354R10 device.

Special attention must be paid to RF component placement, decoupling capacitors, and DC/DC regulator components, as well as ground connections for all of these.

[CC1352REM-XD7793-XD24 Design Files](#) The CC1352REM-XD7793-XD24 reference design provides schematic, layout, and production files for the characterization board used for deriving the performance number found in this document.

[LP-EM-CC1354P10-1 Design Files](#) Detailed schematics and layouts for the multiband CC1354P10 LaunchPad evaluation board featuring 868/915MHz RF matching on the 20dBm PA output and up to 5dBm TX power at 2.4GHz.

[LP-EM-CC1354P10-6 Design Files](#) Detailed schematics and layouts for the multiband CC1354P10 LaunchPad evaluation board featuring 2.4GHz RF matching optimized for 10dBm operation on the 20dBm PA output and up to 13dBm TX power at 433MHz.

[Sub-1 GHz and 2.4 GHz Antenna Kit for LaunchPad™ Development Kit and SensorTag](#) The antenna kit allows real-life testing to identify the optimal antenna for your application. The antenna kit includes 16 antennas for frequencies from 169MHz to 2.4GHz, including:

- PCB antennas
- Helical antennas
- Chip antennas
- Dual-band antennas for 868MHz and 915MHz combined with 2.4GHz

The antenna kit includes a JSC cable to connect to the Wireless MCU LaunchPad Development Kits and SensorTags.

## 9.2 Junction Temperature Calculation

This section shows the different techniques for calculating the junction temperature under various operating conditions. For more details, see [Semiconductor and IC Package Thermal Metrics](#).

There are three recommended ways to derive the junction temperature from other measured temperatures:

1. From package temperature:

$$T_J = \psi_{JT} \times P + T_{\text{case}} \quad (1)$$

2. From board temperature:

$$T_J = \psi_{JB} \times P + T_{\text{board}} \quad (2)$$

3. From ambient temperature:

$$T_J = R_{\theta JA} \times P + T_A \quad (3)$$

P is the power dissipated from the device and can be calculated by multiplying current consumption with supply voltage. Thermal resistance coefficients are found in [Section 7.8](#).

$$T_J = 23.4^{\circ}\text{C}/\text{W} \times 51.8\text{mW} + T_A = 1.2^{\circ}\text{C} + T_A \quad (4)$$

For various application use cases, current consumption for other modules may have to be added to calculate the appropriate power dissipation. For example, the MCU may be running simultaneously as the radio, peripheral modules may be enabled, and so on. Typically, the easiest way to find the peak current consumption, and thus the peak power dissipation in the device, is to measure as described in [Measuring CC13xx and CC26xx current consumption](#).

## 10 Device and Documentation Support

TI offers an extensive line of development tools. Tools and software to evaluate the performance of the device, generate code, and develop solutions are listed as follows.

### 10.1 Tools and Software

The CC1354R10 device is supported by a variety of software and hardware development tools.

#### Development Kit

##### [CC1354P10-1 LaunchPad™ Development Kit](#)

The CC1354P10-1 LaunchPad™ Development Kit enables the development of high-performance wireless applications in the 863MHz to 930MHz and 2.4GHz frequency bands that benefit from low-power operation. The kit features the CC1354P10 multiband and multiprotocol SimpleLink™ Wireless MCU with an integrated High-Power Amplifier. The kit works with the LaunchPad ecosystem, easily enabling additional functionality like sensors, displays, and more.

The RF configuration of the LaunchPad enables up to +20dBm output power for 863MHz to 930MHz and +5dBm output power for 2.4GHz.

##### [CC1354P10-6 LaunchPad™ Development Kit](#)

The CC1354P10-6 LaunchPad™ Development Kit enables the development of high-performance wireless applications in the 863MHz to 930MHz and 2.4GHz frequency bands that benefit from low-power operation. The kit features the CC1354P10 multiband and multiprotocol SimpleLink™ Wireless MCU with an integrated High-Power Amplifier. The kit works with the LaunchPad ecosystem, easily enabling additional functionality like sensors, displays, and more. The built-in EnergyTrace™ software is an energy-based code analysis tool that measures and displays the application's energy profile and helps to optimize it for ultra-low power consumption.

The RF configuration of the LaunchPad enables up to +14dBm output power for 863MHz to 930MHz and +20dBm output power for 2.4GHz.

##### [LP-XDS110 LaunchPad™ Debug Probe](#)

The LP-XDS110 LaunchPad™ Debug Probe enables the development of high-performance wireless applications in the entire family of LP-EM LaunchPad™ development boards. Featuring a seamless connection with the new 20-pin LP-EM Debug connector, it supports not only multiple standards such as JTAG/cJTAG/SWD but also a UART backchannel for maximum debugging flexibility. It also features an Arm® 10-pin Debug connector to perform debugging on any custom board.

##### [LP-XDS110ET LaunchPad™ Debug Probe](#)

The LP-XDS110ET LaunchPad™ Debug Probe enables the development of high-performance wireless applications in the entire family of LP-EM LaunchPad™ development boards. Featuring a seamless connection with the new 20-pin LP-EM Debug connector, it supports not only multiple standards such as JTAG/cJTAG/SWD but also a UART backchannel for maximum debugging flexibility. In addition, it also features an Arm® 10-pin Debug connector to perform debugging on any custom board. This Debug Probe also features the XDS110 EnergyTrace™ technology, which is a new method for measuring the current consumption that captures the complete operational profile of the wireless MCU.

##### [TMDSEMU110-U Debug Probe](#)

The TMDSEMU110-U Debug Probe enables the development of high-performance wireless applications in the entire family of SimpleLink™ LaunchPad™ development boards. Featuring a convenient enclosure, which grants the proper mechanical robustness for field and production environments, it supports not only multiple standards such as JTAG/cJTAG/SWD but also a UART backchannel and four GPIOs for maximum debugging flexibility. In addition, the expansion connector allows using the [TMDSEMU110-ETH](#) add-on (sold separately), which adds the full-featured XDS110 EnergyTrace™ technology with

variable supply voltage from 1.8V to 3.6V and up to 800mA of supply current. The XDS110 EnergyTrace™ technology is a new method for measuring the current consumption that captures the complete operational profile of the wireless MCU.

## Software

### SimpleLink™ LOWPOWER F2 SDK

The SimpleLink™ LOWPOWER F2 Software Development Kit (SDK) provides a complete package for the development of wireless applications on the CC13XX / CC26XX family of devices. The SDK includes a comprehensive software package for the CC1354R10 device, including the following protocol stacks:

- Bluetooth Low Energy 4 and 5.3
- Thread (based on OpenThread)
- TI Z-Stack (Zigbee 3.0)
- TI 15.4-Stack—an IEEE 802.15.4-based star networking solution for Sub-1GHz and 2.4GHz
- EasyLink - a large set of building blocks for building proprietary RF software stacks
- Multiprotocol support—concurrent operation between stacks using the Dynamic Multiprotocol Manager (DMM)
- TI Wi-SUN FAN Stack
- Matter

The SimpleLink™ LOWPOWER F2 SDK is part of TI's SimpleLink™ MCU platform, offering a single development environment that delivers flexible hardware, software, and tool options for customers developing wired and wireless applications. For more information about the SimpleLink™ MCU Platform, visit [ti.com/simplelink](https://ti.com/simplelink).

## Development Tools

### Code Composer Studio™ Integrated Development Environment (IDE)

Code Composer Studio is an integrated development environment (IDE) that supports TI's Microcontroller and Embedded Processors portfolio. Code Composer Studio comprises a suite of tools used to develop and debug embedded applications. It includes an optimizing C/C++ compiler, source code editor, project build environment, debugger, profiler, and many other features. The intuitive IDE provides a single user interface taking you through each step of the application development flow. Familiar tools and interfaces allow users to get started faster than ever before. Code Composer Studio combines the advantages of the Eclipse® software framework with advanced embedded debug capabilities from TI resulting in a compelling feature-rich development environment for embedded developers.

CCS has support for all SimpleLink™ Wireless MCUs and includes support for EnergyTrace™ software (application energy usage profiling). A real-time object viewer plugin is available for TI-RTOS, part of the SimpleLink™ SDK.

Code Composer Studio is provided free of charge when used in conjunction with the XDS debuggers included on a LaunchPad Development Kit.

### Code Composer Studio™ Cloud IDE

Code Composer Studio (CCS) Cloud is a web-based IDE that allows you to create, edit, and build CCS and Energia™ projects. After you have successfully built your project, you can download and run on your connected LaunchPad. Basic debugging, including features like setting breakpoints and viewing variable values, is now supported with CCS Cloud.

### IAR Embedded Workbench® for Arm®

IAR Embedded Workbench® is a set of development tools for building and debugging embedded system applications using Assembler, C, and C++. It provides a completely integrated development environment that includes a project manager, editor, and build tools. IAR has support for all SimpleLink™ Wireless MCUs. It offers broad debugger support, including XDS110, IAR I-jet™, and Segger J-Link™. A real-time object viewer plugin is

available for TI-RTOS, part of the SimpleLink™ SDK. IAR is also supported out-of-the-box on most software examples provided as part of the SimpleLink™ SDK.

A 30-day evaluation or a 32kB size-limited version is available through [iar.com](http://iar.com).

### SmartRF™ Studio 7

SmartRF™ Studio 7 is a Windows® application that can be used to evaluate and configure SimpleLink™ Wireless MCUs from Texas Instruments. The application will help designers of RF systems to easily evaluate the radio at an early stage in the design process. It is especially useful for the generation of configuration register values and for practical testing and debugging of the RF system. SmartRF Studio can be used either as a standalone application or together with applicable evaluation boards or debug probes for the RF device. Features of the SmartRF Studio include:

- Link tests—send and receive packets between nodes
- Antenna and radiation tests—set the radio in continuous wave TX and RX states
- Export radio configuration code for use with the TI SimpleLink™ SDK RF driver
- Custom GPIO configuration for signaling and control of external switches

### Sensor Controller Studio

Sensor Controller Studio is used to write, test, and debug code for the Sensor Controller peripheral. The tool generates a Sensor Controller Interface driver, which is a set of C source files that are compiled into the System CPU application. These source files also contain the Sensor Controller binary image and allow the System CPU application to control and exchange data with the Sensor Controller. Features of the Sensor Controller Studio include:

- Ready-to-use examples for several common use cases
- Full toolchain with built-in compiler and assembler for programming in a C-like programming language
- Provides rapid development by using the integrated sensor controller task testing and debugging functionality, including visualization of sensor data and verification of algorithms

### UniFlash

UniFlash is a standalone tool used to program on-chip flash memory on TI MCUs. UniFlash has a GUI, command line, and scripting interface. UniFlash is available free of charge.

## 10.1.1 SimpleLink™ Microcontroller Platform

The SimpleLink™ microcontroller platform sets a new standard for developers with the broadest portfolio of wired and wireless Arm® MCUs (System-on-Chip) in a single software development environment. Delivering flexible hardware, software and tool options for your IoT applications. Invest once in the SimpleLink™ software development kit and use throughout your entire portfolio. Learn more on [ti.com/simplelink](http://ti.com/simplelink).

## 10.2 Documentation Support

To receive notification of documentation updates on data sheets, errata, application notes and similar, navigate to the device product folder on [ti.com/product/CC1354R10](http://ti.com/product/CC1354R10). In the upper right corner, click on *Alert me* to register and receive a weekly digest of any product information that has changed. For change details, review the revision history included in any revised document.

The current documentation that describes the MCU, related peripherals, and other technical collateral is listed as follows.

### TI Resource Explorer

[TI Resource Explorer](#) Software examples, libraries, executables, and documentation are available for your device and development board.

### Errata

[CC1354R10 Silicon Errata](#)

The silicon errata describes the known exceptions to the functional specifications for each silicon revision of the device and description on how to recognize a device revision.

## Application Reports

All application reports for the CC1354R10 device are found on the device product folder at: [ti.com/product/CC1354R10/technicaldocuments](https://ti.com/product/CC1354R10/technicaldocuments).

## Technical Reference Manual (TRM)

[CC13x4, CC26x4 SimpleLink™ Wireless MCU Technical Reference Manual](#)

The TRM provides detailed descriptions of all modules and peripherals available in the device family.

## 10.3 Support Resources

[TI E2E™ support forums](#) are an engineer's go-to source for fast, verified answers and design help — straight from the experts. Search existing answers or ask your own question to get the quick design help you need.

Linked content is provided "AS IS" by the respective contributors. They do not constitute TI specifications and do not necessarily reflect TI's views; see TI's [Terms of Use](#).

## 10.4 Trademarks

SimpleLink™, LaunchPad™, EnergyTrace™, Code Composer Studio™, and TI E2E™ are trademarks of Texas Instruments.

I-jet™ is a trademark of IAR Systems AB.

J-Link™ is a trademark of SEGGER Microcontroller Systeme GmbH.

Arm®, Cortex®, and TrustZone® are registered trademarks of Arm Limited (or its subsidiaries) in the US and/or elsewhere.

CoreMark® is a registered trademark of Embedded Microprocessor Benchmark Consortium Corporation.

Arm Thumb® are registered trademarks of Arm Limited (or its subsidiaries).

Wi-Fi® is a registered trademark of Wi-Fi Alliance.

Bluetooth® is a registered trademark of Bluetooth SIG Inc.

Zigbee® is a registered trademark of Zigbee Alliance Inc.

is a registered trademark of Arm Limited.

Eclipse® is a registered trademark of Eclipse Foundation.

IAR Embedded Workbench® is a registered trademark of IAR Systems AB.

Windows® is a registered trademark of Microsoft Corporation.

All trademarks are the property of their respective owners.

## 10.5 Electrostatic Discharge Caution



This integrated circuit can be damaged by ESD. Texas Instruments recommends that all integrated circuits be handled with appropriate precautions. Failure to observe proper handling and installation procedures can cause damage.

ESD damage can range from subtle performance degradation to complete device failure. Precision integrated circuits may be more susceptible to damage because very small parametric changes could cause the device not to meet its published specifications.

## 10.6 Glossary

[TI Glossary](#)

This glossary lists and explains terms, acronyms, and definitions.

## 11 Revision History

NOTE: Page numbers for previous revisions may differ from page numbers in the current version.

### Changes from June 20, 2023 to April 30, 2024 (from Revision A (June 2023) to Revision B (April 2024))

	Page
• Removed preliminary information footnote for RSK package.....	1
• Updated <a href="#">Device Comparison</a> table.....	6
• Updated Sensor controller power consumption in <a href="#">Section 7.5, Power Consumption - Power Modes</a> .....	14
• Updated Flash specifications in <a href="#">Section 7.7, Nonvolatile (Flash) Memory Characteristics</a> .....	14
• Removed redundant blocking and selectivity rows in both <i>Generic OOK (16.384kbps, OOK w / Manchester encoding, 100kHz RX BW)</i> and <i>802.15.4, 50kbps, ±25kHz Deviation, 2-GFSK, 100kHz RX BW (Legacy)</i> of <a href="#">Section 7.10, 861MHz to 1054MHz - Receive (RX)</a> .....	14
• Fixed typo in test conditions for Symbol Rate Tolerance in both <i>802.15.4-2020, 10kbps, 2-FSK, 26kHz RX BW, Mode #1a</i> and <i>802.15.4-2020, 20kbps, 2-FSK, 52 kHz RX BW, Mode #1b</i> of <a href="#">Section 7.10, 861MHz to 1054MHz - Receive (RX)</a> .....	14
• Fixed typo in test conditions for Frequency Error Tolerance (ppm) in <i>802.15.4, 50kbps, ±25kHz Deviation, 2-GFSK, 100kHz RX BW (Legacy)</i> of <a href="#">Section 7.10, 861MHz to 1054MHz - Receive (RX)</a> .....	14
• Merged parameter cells for Blocking -10MHz in <i>WB-DSSS, 240/120/60/30kbps (480 ksym/s, 2-GFSK, ±195kHz Deviation, FEC (Half Rate), DSSS = 1/2/4/8, 622 kHz RX BW)</i> of <a href="#">Section 7.10, 861MHz to 1054MHz - Receive (RX)</a> .....	14
• Fixed incorrectly merged rows of test conditions for both Blocking +5% Fc. and Image rejection parameters in <i>802.15.4-2020, 10kbps, ±5kHz deviation, 2-FSK, 26kHz RX BW, Mode #1a</i> of <a href="#">Section 7.10, 861MHz to 1054MHz - Receive (RX)</a> .....	14
• Updated test conditions for Frequency Error Tolerance in section <i>SimpleLink™ Long Range 2.5/5kbps (20 ksps), ±5kHz Deviation, 2-GFSK, 34 kHz RX Bandwidth, FEC = 1:2, DSSS = 1:4/1:2</i> of <a href="#">Section 7.10, 861MHz to 1054MHz - Receive (RX)</a> .....	14
• Removed redundant Image Rejection row in <i>802.15.4, 50kbps, ±25kHz Deviation, 2-GFSK, 100kHz RX BW (Legacy)</i> of <a href="#">Section 7.10, 861MHz to 1054MHz - Receive (RX)</a> .....	14
• Updated graphs and tables on <a href="#">Typical characteristics</a> .....	44
• Added EnergyTrace information to <a href="#">Section 8.11, Debug</a> .....	63

## 12 Mechanical, Packaging, and Orderable Information

### 12.1 Packaging Information

The following pages include mechanical packaging and orderable information. This information is the most current data available for the designated devices. This data is subject to change without notice and revision of this document. For browser-based versions of this data sheet, refer to the left-hand navigation.

**PACKAGING INFORMATION**

Orderable part number	Status (1)	Material type (2)	Package   Pins	Package qty   Carrier	RoHS (3)	Lead finish/ Ball material (4)	MSL rating/ Peak reflow (5)	Op temp (°C)	Part marking (6)
<a href="#">CC1354R106T0RGZR</a>	Active	Production	VQFN (RGZ)   48	2500   LARGE T&R	Yes	NIPDAU	Level-3-260C-168 HR	-40 to 105	CC1354 R106
CC1354R106T0RGZR.B	Active	Production	VQFN (RGZ)   48	2500   LARGE T&R	Yes	NIPDAU	Level-3-260C-168 HR	-40 to 105	CC1354 R106
<a href="#">CC1354R106T0RSKR</a>	Active	Production	VQFN (RSK)   64	2000   LARGE T&R	Yes	NIPDAU	Level-3-260C-168 HR	-40 to 105	CC1354 R106
CC1354R106T0RSKR.B	Active	Production	VQFN (RSK)   64	2000   LARGE T&R	Yes	NIPDAU	Level-3-260C-168 HR	-40 to 105	CC1354 R106

(1) **Status:** For more details on status, see our [product life cycle](#).

(2) **Material type:** When designated, preproduction parts are prototypes/experimental devices, and are not yet approved or released for full production. Testing and final process, including without limitation quality assurance, reliability performance testing, and/or process qualification, may not yet be complete, and this item is subject to further changes or possible discontinuation. If available for ordering, purchases will be subject to an additional waiver at checkout, and are intended for early internal evaluation purposes only. These items are sold without warranties of any kind.

(3) **RoHS values:** Yes, No, RoHS Exempt. See the [TI RoHS Statement](#) for additional information and value definition.

(4) **Lead finish/Ball material:** Parts may have multiple material finish options. Finish options are separated by a vertical ruled line. Lead finish/Ball material values may wrap to two lines if the finish value exceeds the maximum column width.

(5) **MSL rating/Peak reflow:** The moisture sensitivity level ratings and peak solder (reflow) temperatures. In the event that a part has multiple moisture sensitivity ratings, only the lowest level per JEDEC standards is shown. Refer to the shipping label for the actual reflow temperature that will be used to mount the part to the printed circuit board.

(6) **Part marking:** There may be an additional marking, which relates to the logo, the lot trace code information, or the environmental category of the part.

Multiple part markings will be inside parentheses. Only one part marking contained in parentheses and separated by a "-" will appear on a part. If a line is indented then it is a continuation of the previous line and the two combined represent the entire part marking for that device.

**Important Information and Disclaimer:** The information provided on this page represents TI's knowledge and belief as of the date that it is provided. TI bases its knowledge and belief on information provided by third parties, and makes no representation or warranty as to the accuracy of such information. Efforts are underway to better integrate information from third parties. TI has taken and continues to take reasonable steps to provide representative and accurate information but may not have conducted destructive testing or chemical analysis on incoming materials and chemicals. TI and TI suppliers consider certain information to be proprietary, and thus CAS numbers and other limited information may not be available for release.

In no event shall TI's liability arising out of such information exceed the total purchase price of the TI part(s) at issue in this document sold by TI to Customer on an annual basis.

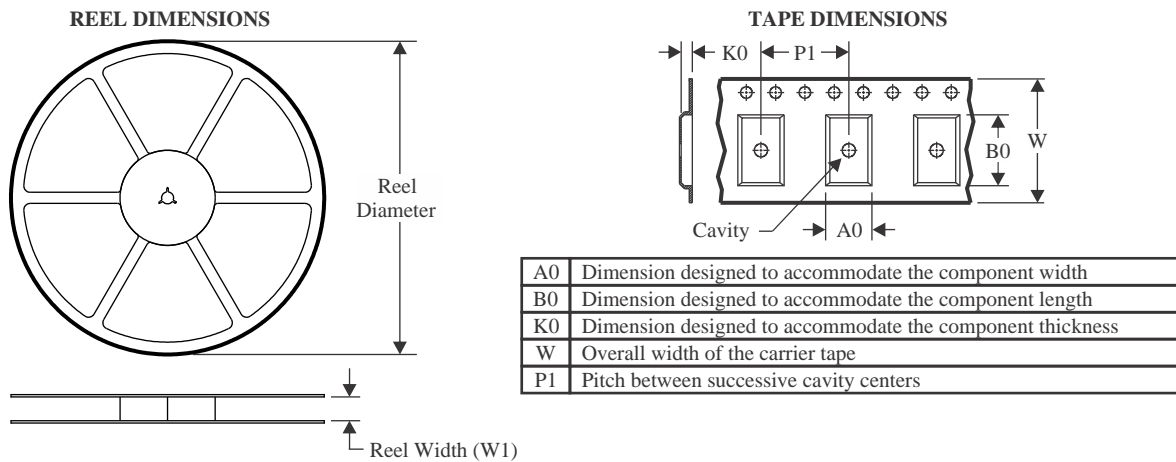
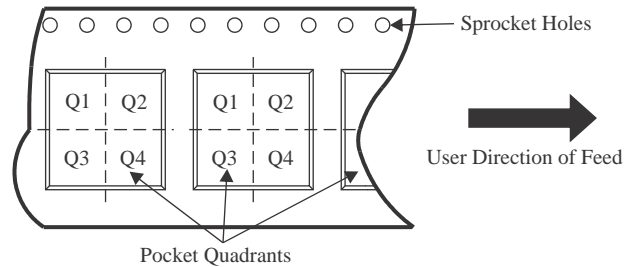

**TAPE AND REEL INFORMATION**

**QUADRANT ASSIGNMENTS FOR PIN 1 ORIENTATION IN TAPE**

\*All dimensions are nominal

Device	Package Type	Package Drawing	Pins	SPQ	Reel Diameter (mm)	Reel Width W1 (mm)	A0 (mm)	B0 (mm)	K0 (mm)	P1 (mm)	W (mm)	Pin1 Quadrant
CC1354R106T0RGZR	VQFN	RGZ	48	2500	330.0	16.4	7.3	7.3	1.1	12.0	16.0	Q2
CC1354R106T0RSKR	VQFN	RSK	64	2000	330.0	16.4	8.3	8.3	1.1	12.0	16.0	Q2

**TAPE AND REEL BOX DIMENSIONS**

\*All dimensions are nominal

Device	Package Type	Package Drawing	Pins	SPQ	Length (mm)	Width (mm)	Height (mm)
CC1354R106T0RGZR	VQFN	RGZ	48	2500	367.0	367.0	35.0
CC1354R106T0RSKR	VQFN	RSK	64	2000	367.0	367.0	35.0

## GENERIC PACKAGE VIEW

**RSK 64**

**VQFN - 1 mm max height**

8 x 8, 0.4 mm pitch

PLASTIC QUAD FLATPACK - NO LEAD

This image is a representation of the package family, actual package may vary.  
Refer to the product data sheet for package details.

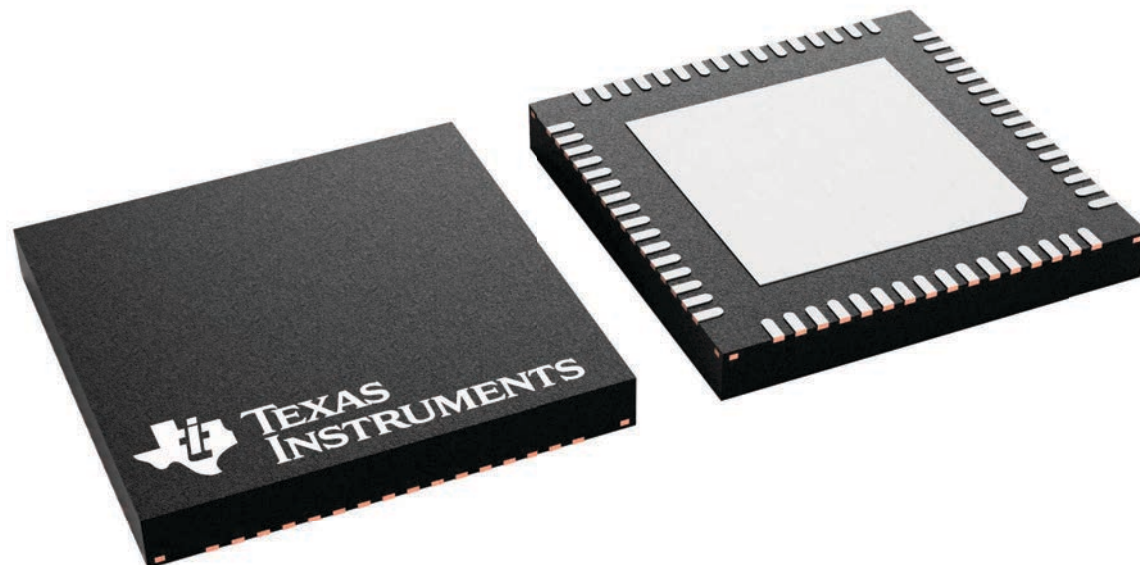

4231455/A

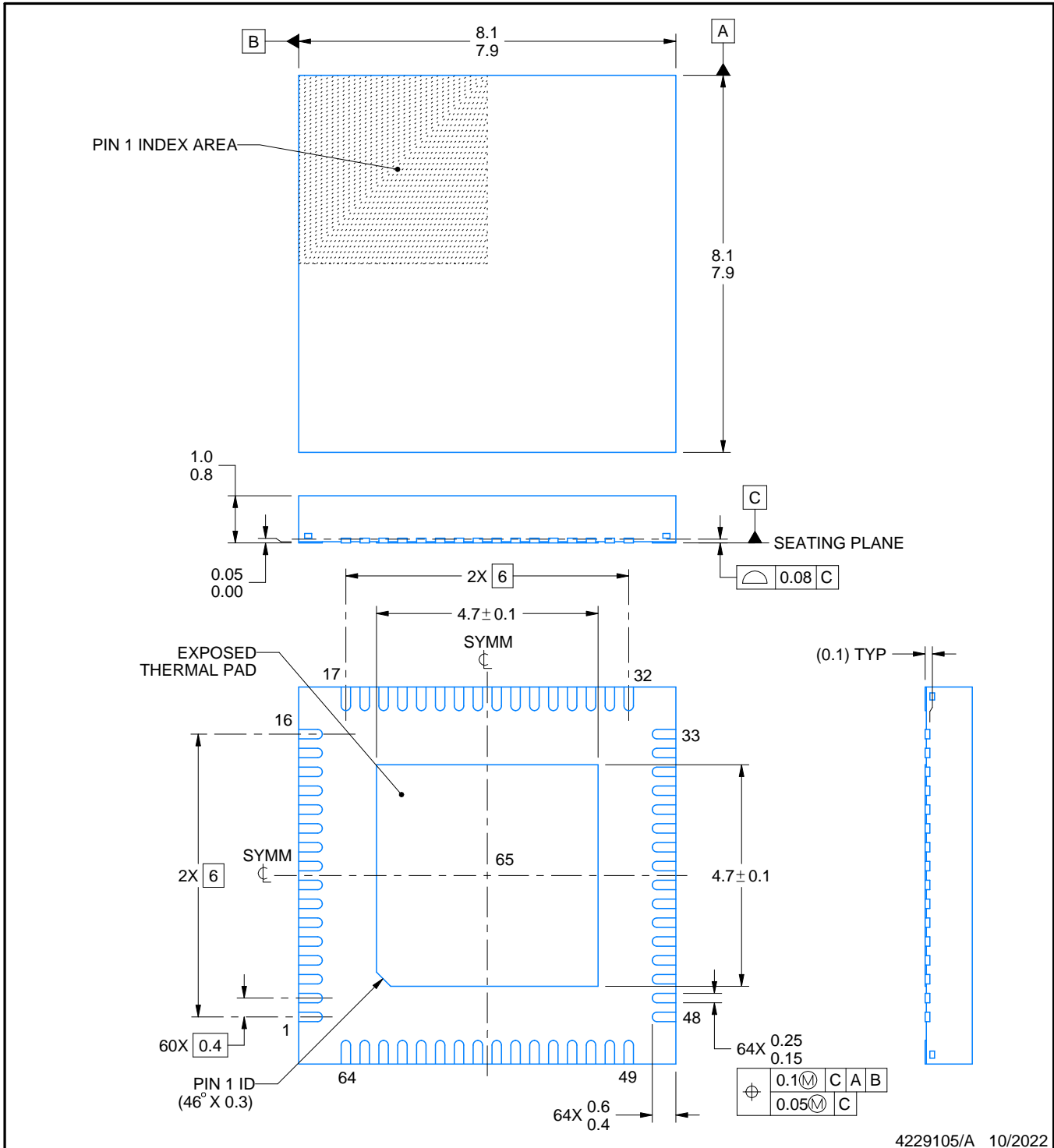
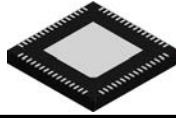

4229105/A 10/2022

NOTES:

1. All linear dimensions are in millimeters. Any dimensions in parenthesis are for reference only. Dimensioning and tolerancing per ASME Y14.5M.
2. This drawing is subject to change without notice.
3. The package thermal pad must be soldered to the printed circuit board for thermal and mechanical performance.



# EXAMPLE STENCIL DESIGN

RSK0064D

VQFN - 1 mm max height

PLASTIC QUAD FLATPACK - NO LEAD

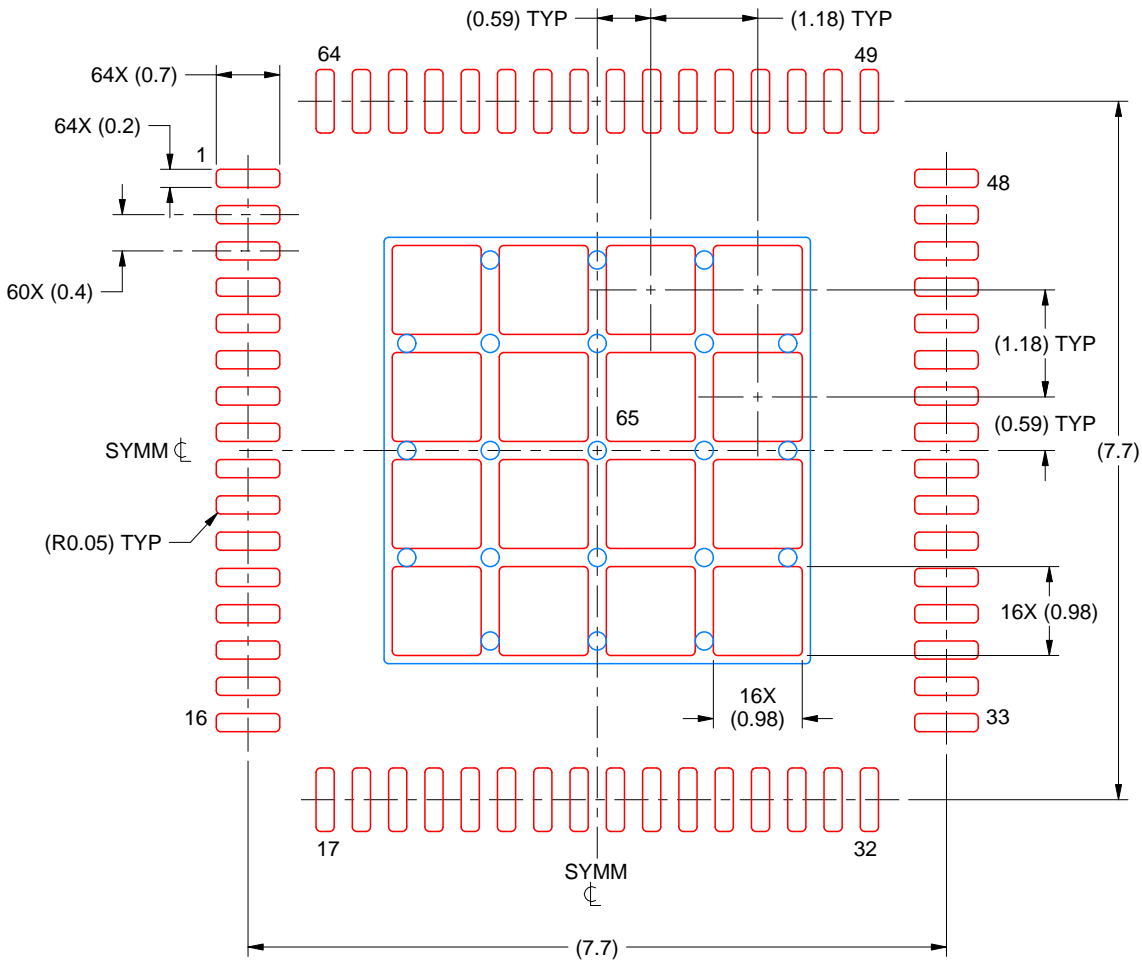

SOLDER PASTE EXAMPLE  
 BASED ON 0.100 MM THICK STENCIL  
 SCALE: 12X

EXPOSED PAD 65  
 70% PRINTED SOLDER COVERAGE BY AREA UNDER PACKAGE

4229105/A 10/2022

NOTES: (continued)

6. Laser cutting apertures with trapezoidal walls and rounded corners may offer better paste release. IPC-7525 may have alternate design recommendations.

## GENERIC PACKAGE VIEW

**RGZ 48**

**VQFN - 1 mm max height**

7 x 7, 0.5 mm pitch

PLASTIC QUADFLAT PACK- NO LEAD

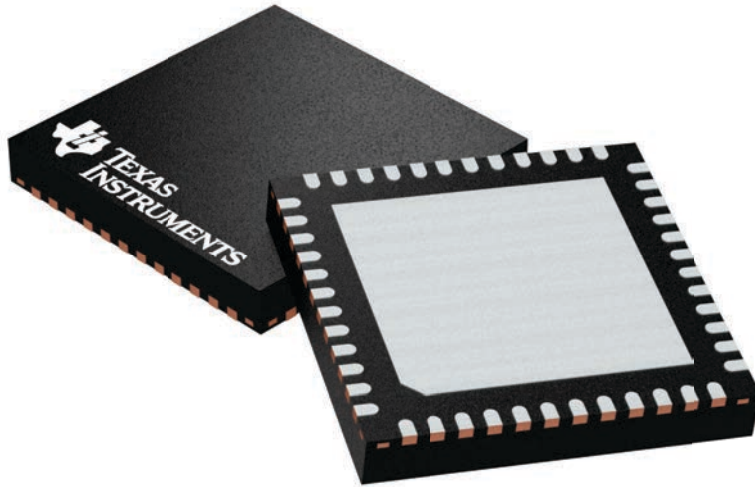

Images above are just a representation of the package family, actual package may vary.  
Refer to the product data sheet for package details.

4224671/A

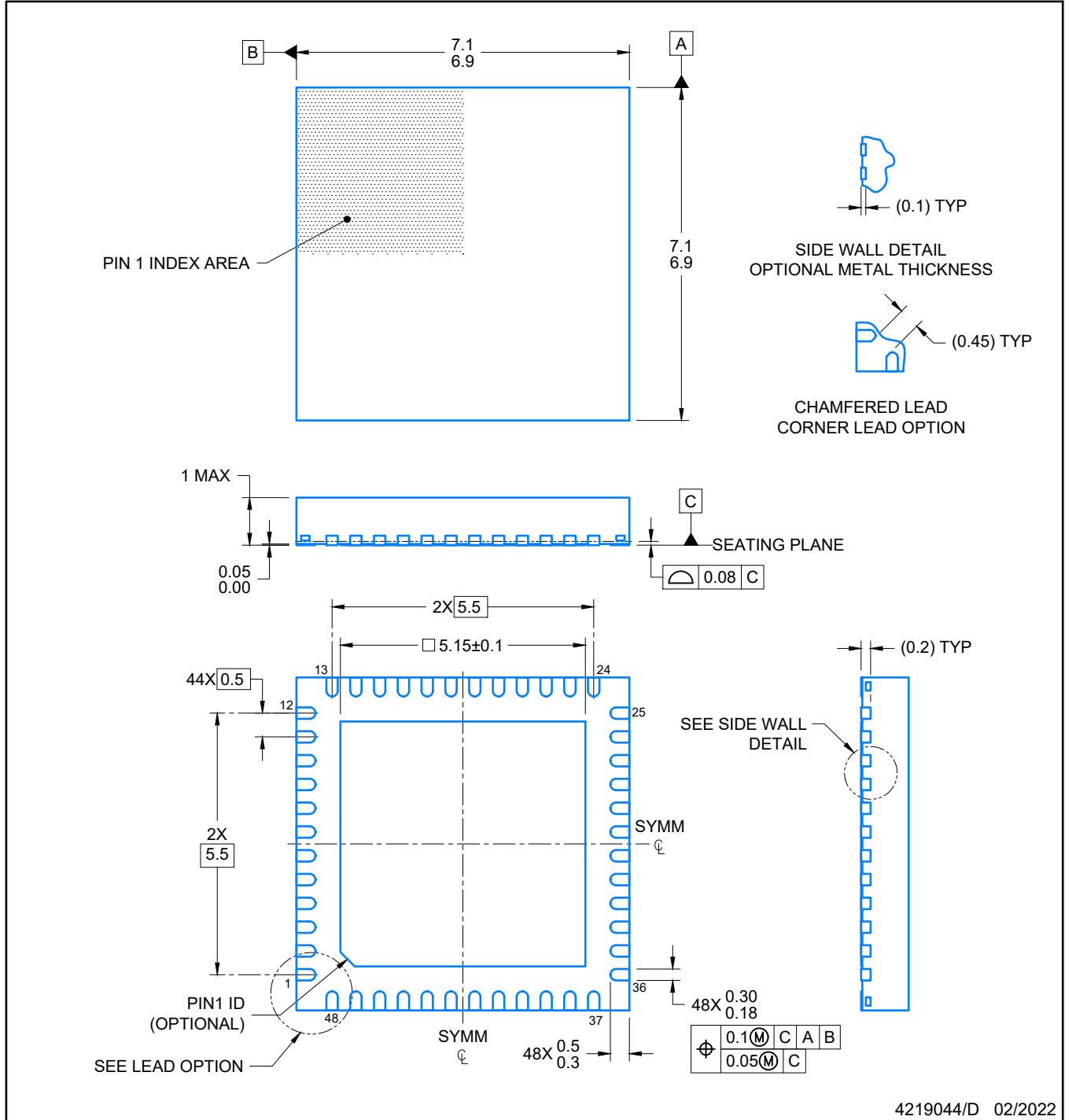

NOTES:

1. All linear dimensions are in millimeters. Any dimensions in parenthesis are for reference only. Dimensioning and tolerancing per ASME Y14.5M.
2. This drawing is subject to change without notice.
3. The package thermal pad must be soldered to the printed circuit board for optimal thermal and mechanical performance.

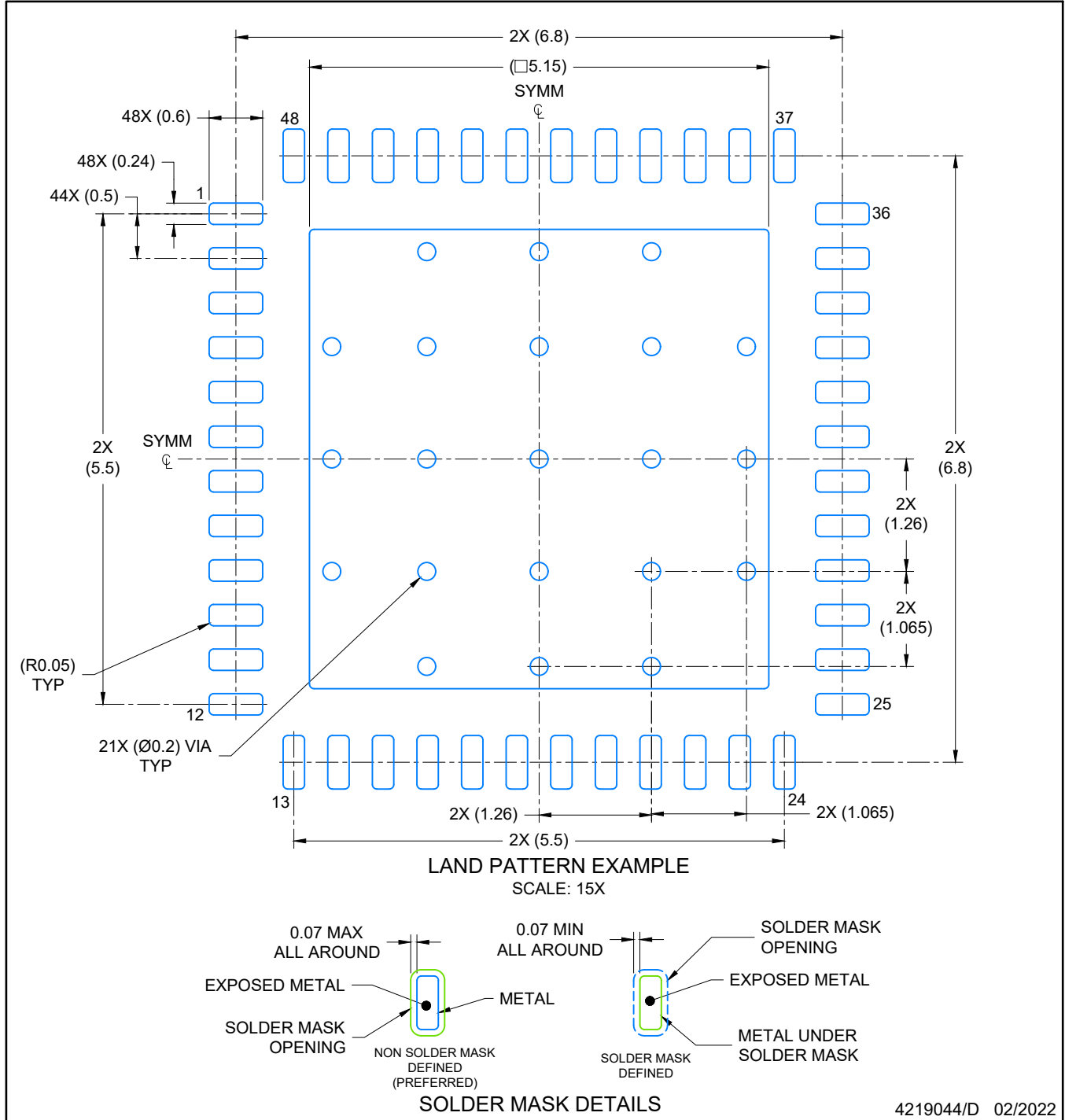

NOTES: (continued)

4. This package is designed to be soldered to a thermal pad on the board. For more information, see Texas Instruments literature number SLUA271 ([www.ti.com/lit/slua271](http://www.ti.com/lit/slua271)).
5. Vias are optional depending on application, refer to device data sheet. If any vias are implemented, refer to their locations shown on this view. It is recommended that vias under paste be filled, plugged or tented.



## IMPORTANT NOTICE AND DISCLAIMER

TI PROVIDES TECHNICAL AND RELIABILITY DATA (INCLUDING DATASHEETS), DESIGN RESOURCES (INCLUDING REFERENCE DESIGNS), APPLICATION OR OTHER DESIGN ADVICE, WEB TOOLS, SAFETY INFORMATION, AND OTHER RESOURCES "AS IS" AND WITH ALL FAULTS, AND DISCLAIMS ALL WARRANTIES, EXPRESS AND IMPLIED, INCLUDING WITHOUT LIMITATION ANY IMPLIED WARRANTIES OF MERCHANTABILITY, FITNESS FOR A PARTICULAR PURPOSE OR NON-INFRINGEMENT OF THIRD PARTY INTELLECTUAL PROPERTY RIGHTS.

These resources are intended for skilled developers designing with TI products. You are solely responsible for (1) selecting the appropriate TI products for your application, (2) designing, validating and testing your application, and (3) ensuring your application meets applicable standards, and any other safety, security, regulatory or other requirements.

These resources are subject to change without notice. TI grants you permission to use these resources only for development of an application that uses the TI products described in the resource. Other reproduction and display of these resources is prohibited. No license is granted to any other TI intellectual property right or to any third party intellectual property right. TI disclaims responsibility for, and you fully indemnify TI and its representatives against any claims, damages, costs, losses, and liabilities arising out of your use of these resources.

TI's products are provided subject to [TI's Terms of Sale](#), [TI's General Quality Guidelines](#), or other applicable terms available either on [ti.com](http://ti.com) or provided in conjunction with such TI products. TI's provision of these resources does not expand or otherwise alter TI's applicable warranties or warranty disclaimers for TI products. Unless TI explicitly designates a product as custom or customer-specified, TI products are standard, catalog, general purpose devices.

TI objects to and rejects any additional or different terms you may propose.

Copyright © 2026, Texas Instruments Incorporated

Last updated 10/2025